

**Corbin  
Russwin** 

**ASSA ABLOY**

## CL3300 Series

Extra Heavy-Duty Cylindrical  
Lever Locksets



ASSA ABLOY, the global leader  
in door opening solutions

# Overview

## CL3300



### Table of Contents

Overview .....	2
Features .....	3
Functions .....	5
Electrified Lockset .....	8
Trim Designs .....	11
Options and Accessories .....	12
How to Order .....	15
Quick Codes .....	16
How to Specify .....	18

[www.corbinrusswin.com](http://www.corbinrusswin.com)

### Quality

 The CL3300 series is a Grade 1 cylindrical lockset manufactured with the highest quality materials to ensure strength, durability and quiet operation. Available in all standard architectural finishes and four lever designs, the CL3300 series subtly complements any high-use commercial, industrial and institutional application.

### Classroom Security

The CL3352 Classroom Intruder function is the solution to classroom security: a double cylinder lockset that allows locking of the outside lever from either side. Egress is always possible with the standard anti-panic feature, whether the door is locked or not. And because a key is needed to secure the door from either side, students cannot lock a teacher out of the classroom.

### Vandal Resistance

Engineered to meet today's increased security needs, the CL3300 series offers several advantages. All functions feature the Lever Release™ design for vandal resistance, allowing the outside lever to rotate when in the locked position.

### Access Control

For access control, the CL33900 Series Electrified Cylindrical lockset utilizes the proven CL3300 series lockset and features an integral continuous duty solenoid that allows installation in a standard cylindrical prep. Available in Fail Safe or Fail Secure, the CL33900 is ideal for door control where increased security is necessary at all times, while meeting life safety codes.

### Key Advantages

- EZ-Install components significantly reduce installation time
- Lever Release™ lever design for vandal resistance
- Several security key systems available (Access 3®, Pyramid, etc.)
- Access control available with CL33900 Electrified lockset
- ElectroLynx® connectors are standard on all Corbin Russwin electrified products. McKinney QC hinges are recommended to make a complete plug and play application.
- Independent return springs prevent lever sag
- Covers ANSI/BHMA Door Prep A156.115



### Features

#### Handing

Non-handed (Except FZD trim)

#### Door Thickness

1-3/4" (44mm) - 2" (51mm) standard.  
Optional: Over 2" (51mm) - 2-1/4" (57mm); see Quick Codes, page 16.

#### Lock Chassis

Steel, zinc dichromated for corrosion resistance.

#### Backset

2-3/4" (70mm) standard.  
Optional: 3-3/4" (95mm) and 5" (127mm); see Quick Codes, page 16.

#### Latchbolt

Stainless Steel, 1/2" (13mm) throw.  
Optional: 3/4" (19mm) throw deadlocking fire latch for pair of doors; see Quick Codes, page 17.

#### Auxiliary Latchbolt

Deadlocking latchbolt prevents manipulation when door is closed.

#### Front

Wrought brass, bronze, or stainless steel, 2-1/4" (57mm) x 1-1/8" (29mm).  
Accommodates flat doors and doors beveled 1/8" (3mm) in 2" (51mm).  
Optional: rounded corners; see Quick Codes, page 17.

#### Strike

Wrought brass or stainless steel ANSI curved lip standard, 4-7/8" (124mm) x 1-1/4" (32mm) x 1-1/4" (32mm) lip to center.  
Optional strikes, lip lengths and ANSI wrought strike box available; see Quick Codes, page 16.

#### Cylinder

Brass, 6-pin L4 keyway, 0-bitted standard.

#### Keying Features Available

Master keying  
Construction master keying  
Visual key control  
Concealed key control  
Interchangeable core (IC)  
Security  
Security IC (not available with CL3329)  
Pyramid (not available with CL3329)  
Pyramid IC (not available with CL3329)  
Access 3®  
Access 3® IC (not available with CL3329)

#### Keys

Two nickel silver standard.

#### Warranty

Seven-year limited.

#### Classroom Security

The CL3352 Classroom Intruder function lockset allows locking of the outside lever from either side with the key. In a panic situation, the Key Turn Indicator serves as a quick reference for locking the door. And egress is always possible with the "anti-panic" feature, which keeps the outside lever locked if the inside lever is activated.



#### MicroShield®

CL3300 series locks are available with MicroShield® antimicrobial coating. MicroShield is a revolutionary hardware finish coating, using a silver ion based technology, which inhibits the growth of bacteria, algae, yeast, fungus, mold and mildew. MicroShield is non-toxic and lasts for the lifetime of the finish to which it is applied. To order, suffix option code "C".

Note: MicroShield® coating may vary finish color from architectural standards. MicroShield is not intended as a substitute for traditional infection control programs such as hand hygiene or use of disinfectants. Coated product must still be cleaned to insure the surfaces will be free of destructive microbes. Corbin Russwin makes no representations or warranties, express or implied, as to the efficacy of the MicroShield antimicrobial.

### Certification/Compliance

#### ANSI/BHMA

Certified A156.2 Series 4000, Grade 1.   
Meets A117.1 Accessibility Code.

#### Federal

Meets FF-H-106C.

#### California State Reference Code

(Formerly Title 19, California State Fire Marshal Standard)

All levers with returns comply; levers return to within 1/2" (13mm) of door face.

#### UL-cUL

All locks with 1/2" (13mm) throw latchbolt listed for A label and lesser class 4' x 10' single doors. All locks with 3/4" (19mm) throw latchbolt listed for A label and lesser class 8' x 10' pairs of doors. Letter F and UL symbol on latch front indicate listing.

Any retrofit or other field modification to a fire-rated opening can potentially impact the fire-rating of the opening, and Corbin Russwin, Inc. makes no representations or warranties concerning what such impact may be in any specific situation. When retrofitting any portion of an existing fire-rated opening, or specifying and installing a new fire-rated opening, please consult with a code specialist or local code official (Authority Having Jurisdiction) to ensure compliance with all applicable codes and ratings.

# Features

## CL3300

### Finishes

	Description	Specify
ANSI/BHMA 605 (US3)	Bright Brass	605
ANSI/BHMA 606 (US4)	Satin Brass	606
ANSI/BHMA 611 (US9)	Bright Bronze	611
ANSI/BHMA 612 (US10)	Satin Bronze	612
ANSI/BHMA 613 (US10B)	Dark Oxidized Satin Bronze, Oil Rubbed	613
613E	Dark Oxidized Satin Bronze - equivalent	613E
613L	Dark Oxidized Satin Bronze, Clear Coated	613L
ANSI/BHMA 618 (US14)	Bright Nickel Plated	618
ANSI/BHMA 619 (US15)	Satin Nickel Plated	619
ANSI/BHMA 625 (US26)	Bright Chromium Plated	625
619C	Satin Nickel Plated with MicroShield®	619C
ANSI/BHMA 626 (US26D)	Satin Chromium Plated	626
626C	Satin Chromium Plated with MicroShield®	626C
ANSI/BHMA 722	Black Oxidized Bronze, Oil Rubbed	722

Zinc levers are plated to match BHMA finish.

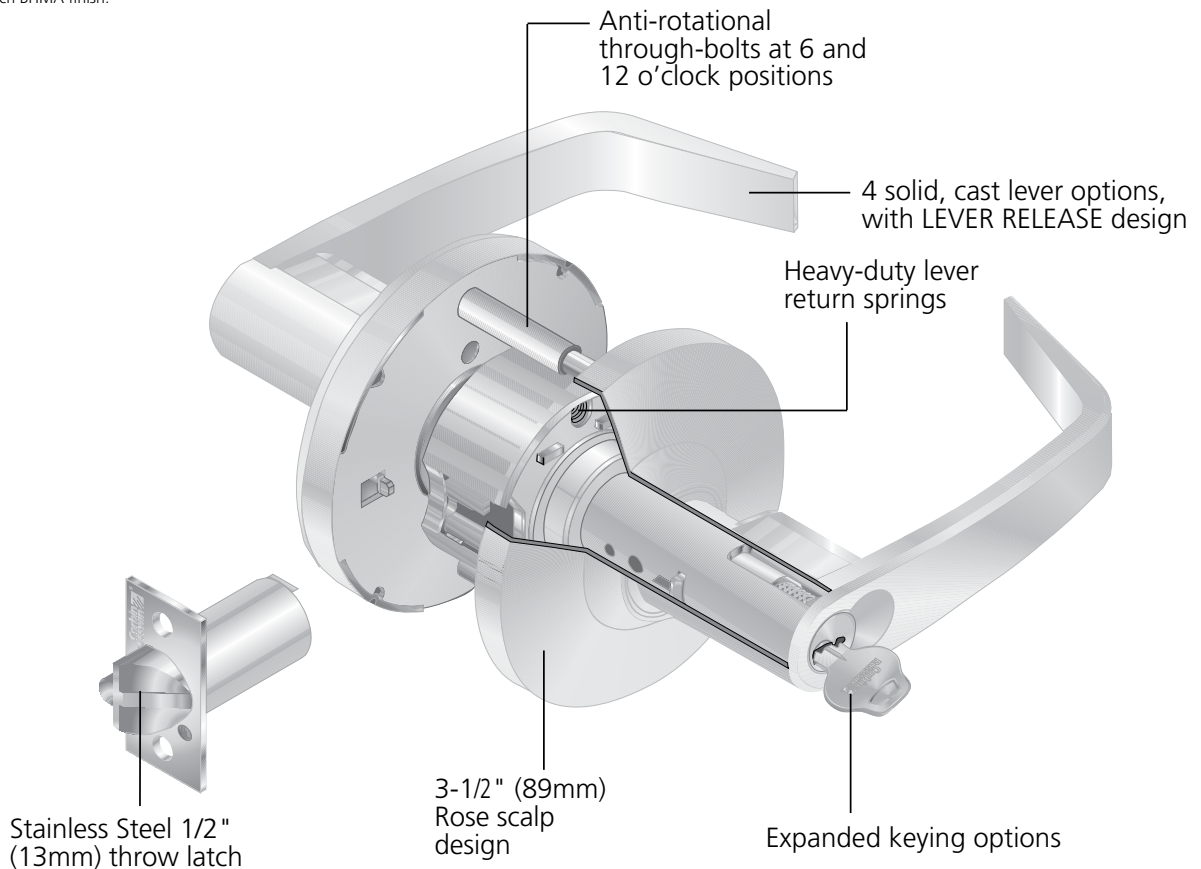

Outside	Inside	Series/Function	Type	ANSI No.	Function Description
		CL3310	Passage or Closet	F75	<ul style="list-style-type: none"> <li>Latchbolt by lever either side.</li> <li>Both levers always free.</li> </ul>
		CL3320	Privacy, Bedroom or Bathroom	F76A	<ul style="list-style-type: none"> <li>Throw-off latchbolt by lever.</li> <li>Outside lever locked by push button. (Lever handle is freewheeling in locked position.)</li> <li>Outside lever unlocked by emergency release tool outside, by rotating inside lever or by closing door.</li> <li>Inside lever always free.</li> </ul>
		CL3320H	Hospital Privacy	—	<ul style="list-style-type: none"> <li>Outside lever locked by inside push button. (Lever handle is freewheeling in locked position.)</li> <li>Outside lever unlocked by simultaneously depressing outside pushbutton while rotating lever.</li> <li>Rotating inside lever or closing door also unlocks outside lever.</li> <li>Outside lever handle is freewheeling when locked.</li> </ul>
		CL3320TO	Time Out Lock	—	<ul style="list-style-type: none"> <li>Latchbolt by lever either side (passage) unless push button depressed and held by caretaker (detention side becomes freewheeling). Lock returns to passage mode upon release of push button.</li> <li>Push button automatically releases when caretaker releases push button.</li> <li>Both levers always free.</li> </ul>
		CL3329	Hotel or Motel	F93	<ul style="list-style-type: none"> <li>Throw-off latchbolt by lever inside or by key outside.</li> <li>Push button shuts out all keys except emergency key, and projects occupancy indicator in face of cylinder. (Lever handle is freewheeling in locked position.)</li> <li>Push button released by turning inside lever or by closing door.*</li> <li>Outside lever always locked.</li> <li>Inside lever always free.</li> <li>Not available with other manufacturers keyways</li> </ul>
		CL3332	Institutional or Utility	F87	<ul style="list-style-type: none"> <li>Deadlocking latchbolt by key either side. (Lever handles are freewheeling in locked position.)</li> <li>Should be used only in office or room with multiple entries.</li> </ul>
		CL3340	Patio or Privacy	F77	<ul style="list-style-type: none"> <li>Throw-off latchbolt by lever.</li> <li>Outside lever locked by push button. (Lever handle is freewheeling in locked position.)</li> <li>Inside lever always free.</li> <li>Should not be used in rooms that have no other entrance.</li> </ul>
		CL3340NT	Exit Latch	F89	<ul style="list-style-type: none"> <li>Deadlocking latchbolt by lever inside.</li> <li>Outside lever always locked. (Lever handle is freewheeling in locked position.)</li> <li>Inside lever always free.</li> </ul>



Indicates optional interchangeable core available; see Quick Codes, page 16.



Indicates freewheeling lever in locked position.

\*Unless push button has been fixed in locked position by spanner key (furnished). When push button is fixed by spanner key, lock is operable only by emergency key or by display key.

# Functions

## CL3300



Outside	Inside	Series/Function	Type	ANSI No.	Function Description
		CL3351	Entrance or Office	F109	<ul style="list-style-type: none"> <li>Deadlocking latchbolt by lever either side, except when turn button locks outside lever. Pushing turn button in locks outside lever, requiring use of key outside to unlock. (Lever handle is freewheeling in locked position.)</li> <li>Turning inside lever unlocks outside lever.</li> <li>Pushing in and turning button locks outside lever, requiring key at all times. Turning inside lever does not unlock outside lever until button is manually turned to unlocked position.</li> <li>Inside lever always free.</li> </ul>
		CL3352	Classroom Intruder	F110	<ul style="list-style-type: none"> <li>Deadlocking latchbolt by inside lever or outside lever except when key inside or outside locks outside lever. (Lever handle is freewheeling in the locked position.)</li> <li>Outside lever is locked and unlocked by turning the key in the inside or outside lever.</li> <li>Inside lever always free.</li> </ul>
		CL3355	Classroom	F84	<ul style="list-style-type: none"> <li>Deadlocking latchbolt by lever either side, except when key outside locks outside lever. (Lever handle is freewheeling in locked position.)</li> <li>Outside lever unlocked by key outside.</li> <li>Inside lever always free.</li> </ul>
		CL3357	Storeroom or Closet	F86	<ul style="list-style-type: none"> <li>Deadlocking latchbolt by key in outside lever or by rotating inside lever. (Lever handle is freewheeling in locked position.)</li> <li>Inside lever always free.</li> </ul>
		CL3359	Barrier Free Storeroom or Public Restroom	—	<ul style="list-style-type: none"> <li>Deadlocking latchbolt by inside lever.</li> <li>Key outside unlocks outside lever to retract latchbolt.</li> <li>Key is retained in unlock mode.</li> <li>When key is removed outside lever is locked. (Lever handle is freewheeling in locked position.)</li> <li>Inside lever always free.</li> </ul>
		CL3361	Entry or Office	F82A	<ul style="list-style-type: none"> <li>Deadlocking latchbolt by lever either side, except when push button locks outside lever.</li> <li>Push button released by turning inside lever or by key in outside lever. (Lever handle is freewheeling in locked position.)</li> <li>Closing door does not release push button.</li> <li>Inside lever always free.</li> </ul>
		CL3362	Communicating	F80	<ul style="list-style-type: none"> <li>Deadlocking latchbolt by lever either side, except when key in either lever locks and unlocks the lever independently of the other. (Lever handle is freewheeling in locked position.)</li> <li>Keyed alike unless otherwise specified.</li> <li>Should be used only in office or room with multiple entries.</li> </ul>
		CL3372	Apartment, Exit or Public Toilet	F88	<ul style="list-style-type: none"> <li>Deadlocking latchbolt by lever either side, except when key inside locks outside lever. (Lever handle is freewheeling in locked position.)</li> <li>Key outside retracts latchbolt.</li> <li>Key inside unlocks outside lever.</li> <li>Inside lever always free.</li> <li>Keyed alike unless otherwise specified.</li> </ul>



Indicates optional interchangeable core available; see Quick Codes, page 16.

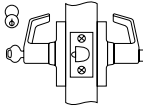
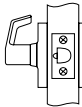
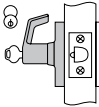
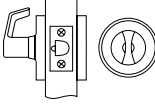
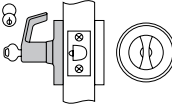
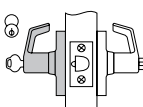

Indicates freewheeling lever in locked position.

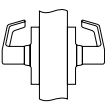
Outside	Inside	Series/Function	Type	ANSI No.	Function Description
		CL3375	Corridor/ Dormitory Lock	F90	<ul style="list-style-type: none"> <li>• Throw-off latchbolt by lever either side except when pushbutton or key locks outside lever.</li> <li>• Pushbutton released by turning inside lever or by closing door.</li> <li>• Depressed pushbutton indicates door is locked.</li> <li>• When outside lever is locked by key, it can only be unlocked by key.</li> <li>• Inside lever always free.</li> <li>• Outside lever rigid when locked.</li> </ul>
		CL3380	Passage Lever x Blank Plate	F111	<ul style="list-style-type: none"> <li>• Latchbolt by lever.</li> <li>• Lever on one side; blank plate on other side.</li> <li>• Lever always free.</li> <li>• For single or double communicating doors.</li> </ul>
		CL3381	Keyed Lever x Blank Plate	F113	<ul style="list-style-type: none"> <li>• Deadlocking latchbolt by lever, except when lever is locked by key. (Lever handle is freewheeling in locked position.)</li> <li>• Lever on one side; blank plate on other side.</li> <li>• Key unlocks lever</li> </ul>
		CL3390	Passage Lever x Turnpiece	—	<ul style="list-style-type: none"> <li>• Latchbolt by lever or by turnpiece.</li> <li>• Lever on one side; turnpiece on other side.</li> <li>• Lever and turnpiece always free.</li> </ul>
		CL3391	Keyed Lever x Turnpiece	—	<ul style="list-style-type: none"> <li>• Deadlocking latchbolt by lever or turnpiece, except when lever is locked by key.</li> <li>• When lever is locked, latchbolt is operated by key in lever or by turnpiece. (Lever handle is freewheeling in locked position.)</li> <li>• Lever on outside; turnpiece on inside.</li> <li>• Turnpiece always free.</li> </ul>
		CL3393	Service Station	F92	<ul style="list-style-type: none"> <li>• Throw-off latchbolt by lever.</li> <li>• Outside lever locked by slotted push button. (Lever handle is freewheeling in locked position.)</li> <li>• When slotted push button is pushed in and turned, outside lever becomes freewheeling and deadlocking latch is activated. Outside lever is unlocked by using key or by rotating inside lever, when slotted push button returned to original position.</li> <li>• Inside lever always free.</li> </ul>
		CL3350	Half Dummy Trim	—	<ul style="list-style-type: none"> <li>• Lever acts as pull only; no operation.</li> <li>• Lever is rigid.</li> </ul>
		CL3370	Full Dummy Trim	—	<ul style="list-style-type: none"> <li>• Levers act as pulls only; no operation.</li> <li>• Levers are rigid.</li> </ul>



Indicates optional interchangeable core available; see Quick Codes, page 16.



Indicates freewheeling lever in locked position.

# CL33900 Electrified Lockset

## CL3300

### Applications

Provides remote locking and unlocking, utilizing the proven CL3300 Series Cylindrical Lockset. Ideal for door control where increased security is necessary at all times, while meeting life safety codes.

- Stairwell towers
- Tenant space
- Pharmacies
- Computer rooms
- High-security areas

### Advantages

- Utilizes the CL3300 Series Cylindrical Lockset with Lever Release™ Mechanism
- Self-contained integral solenoid allows installation in modified cylindrical prep
- Minimal power requirements – device is designed to lock or unlock as the situation demands
- Available in either 12 or 24VAC/VDC
- Mechanical cylinder override
- Fail Safe and Fail Secure mode available
- Optional M92 Request to Exit (REX) switch
- ElectroLynx® 8-pin connector

### ElectroLynx®

ElectroLynx®, a new quick-connect feature of ASSA ABLOY Group companies, takes the guesswork out of installing electrified door hardware products. It's ... **Hardwiring Made Easy.** By using standard "plug and play" connectors, a simple "click" links power from the incoming source to electrified locking products, including hinges, locks, exit devices, magnetic holders, and strikes. What normally takes an hour or more can be connected in virtually minutes.

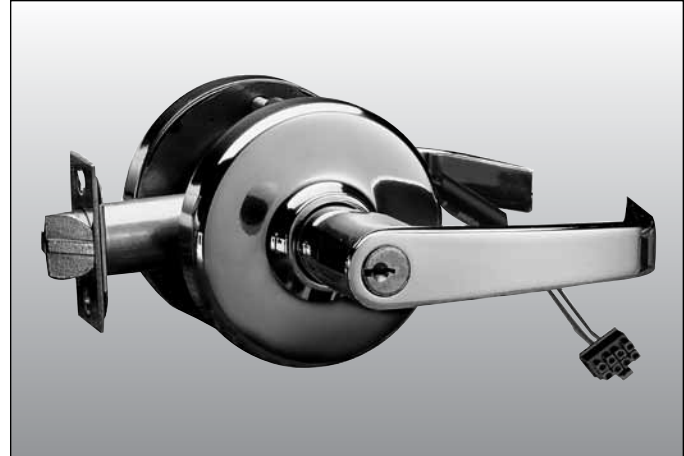

### Securitron PowerJump™ ICPT

The Securitron PowerJump ICPT Inductive Coupling Power Transfer delivers power contactlessly and invisibly between the frame and door to power electrified hardware on the door. The PowerJump can be installed at the latch side or hinge side of the door and transfers up to 6 watts of power without pins or wires across the door gap, eliminating points of vulnerability and wear ... and no need to core drill the door. The PowerJump is field selectable for 12VDC or 24VDC systems and is ideal for fail secure applications. The unit can hold electrified latches open in continuous duty or can momentarily energize the lockset for latch retraction.



Additional information regarding this product can be found at [www.securitron.com](http://www.securitron.com)

### Functions

Outside	Inside	Series/Function	Function Description
		CL33903	<b>Fail Safe</b> <ul style="list-style-type: none"> <li>• Deadlocking latchbolt by lever either side except when power on locks outside lever</li> <li>• Power off/unlocks outside lever</li> <li>• Inside lever always free</li> <li>• Latchbolt retracted by key when locked electrically</li> </ul>
		CL33905	<b>Fail Secure</b> <ul style="list-style-type: none"> <li>• Deadlocking latchbolt by lever either side except when power off locks outside lever</li> <li>• Power on/unlocks outside lever</li> <li>• Inside lever always free</li> <li>• Latchbolt retracted by key when power is off</li> </ul>



# CL33900 Electrified Lockset

CL3300

## Features

### Non-Handed (Except FZD trim)

#### Door Thickness

1-3/4" (44mm) - 2" (51mm) standard.  
Optional: Over 2" (51mm) - 2-1/4" (57mm); see Quick Codes, page 16.

#### Lock Chassis

Steel, zinc dichromated for corrosion resistance.

#### Backset

2-3/4" (70mm) standard.  
Optional: 3-3/4" (95mm) and 5" (127mm); see Quick Codes, page 16.

#### Latchbolt

Stainless Steel, 1/2" (13mm) throw.  
Optional: 3/4" (19mm) throw deadlocking fire latch for pair of doors; see Quick Codes, page 17.

#### Auxiliary Latchbolt

Deadlocking latchbolt prevents manipulation when door is closed.

#### Front

Wrought brass or bronze, 2-1/4" (57mm) x 1-1/8" (29mm). Accommodates flat doors and doors beveled 1/8" (3mm) in 2" (51mm).  
Optional: rounded corners; see Quick Codes, page 17.

#### Strike

Wrought brass, bronze, or stainless steel, ANSI curved lip standard, 4-7/8" (124mm) x 1-1/4" (32mm) x 1-1/4" (32mm) lip to center.  
Optional strikes, lip lengths and ANSI wrought strike box available; see Quick Codes, pages 16.

#### Trims

Available with all lever designs: Armstrong, Newport, Princeton, Frascati.

#### Cylinder

Brass, 6-pin L4 keyway, 0-bitted standard.

## Keying Features Available

Master keying  
Construction master keying  
Visual key control  
Concealed key control  
Interchangeable core (IC)  
Security  
Security IC  
Pyramid  
Pyramid IC  
Access 3®  
Access 3® IC

## Keys

Two nickel silver standard.

## Voltage

Locks are universal for AC or DC. Available with 12VAC/DC or 24VAC/DC. See Quick Codes, page 17.

## Electrical Specifications

250mA @ 12VAC/VDC  
150mA @ 24VAC/VDC  
Continuous duty solenoid.

## Monitoring Option

### M92 - Request to Exit Monitoring (Non-Handed)

Request to Exit monitoring is a SPDT switch which monitors the activation of the trim.

## Warranty

Two-year limited.

## Finishes

	Description	Specify
ANSI/BHMA 605 (US3)	Bright Brass	605
ANSI/BHMA 606 (US4)	Satin Brass	606
ANSI/BHMA 611 (US9)	Bright Bronze	611
ANSI/BHMA 612 (US10)	Satin Bronze	612
ANSI/BHMA 613 (US10B)	Dark Oxidized Satin Bronze, Oil Rubbed	613
613E	Dark Oxidized Satin Bronze - equivalent	613E
613L	Dark Oxidized Satin Bronze, Clear Coated	613L
ANSI/BHMA 618 (US14)	Bright Nickel Plated	618
ANSI/BHMA 619 (US15)	Satin Nickel Plated	619
ANSI/BHMA 625 (US26)	Bright Chromium Plated	625
619C	Satin Nickel Plated with MicroShield®	619C
ANSI/BHMA 626 (US26D)	Satin Chromium Plated	626
626C	Satin Chromium Plated with MicroShield®	626C
ANSI/BHMA 722	Black Oxidized Bronze, Oil Rubbed	722

Zinc levers are plated to match BHMA finish.

# CL33900 Electrified Lockset

## CL3300

### Requirements for Electrical and Data Transfer

To answer the demand for "smart" electronic access control and locking solutions that require fast, easy, and cost-effective installation, ASSA ABLOY Group brands use the ElectroLynx® standardized plug-in connectors and color-coded wiring system.

With *ElectroLynx*, doorway components come pre-wired for easy hookup to the power source. Key to the system is the transfer device hinge that carries power from the frame to the locking hardware.

### Features of ElectroLynx:

- Makes it easy to bring power to the locking hardware
- Wires have connectors that snap together, like plugging a telephone into a jack

To connect a CL33900 series electrified cylindrical lock to the electronic access control system, the following items are required:

- CL33900 series electrified cylindrical lock
- ASSA ABLOY Door Group pre-wired door, or *ElectroLynx* retrofit cable (order from McKinney)
- Electronic transfer device (*ElectroLynx* electronic transfer hinge or Electrical Power Transfer with standard hinge, from McKinney)
- *ElectroLynx* cable from the hinge to above the ceiling (order from McKinney)

Information regarding cable selection, hinge requirements and order strings can be found in the McKinney Transfer Device Solutions catalog. Consult 800-810-WIRE (9473) with questions on application specifications and requirements.

The McKinney QC8 *ElectroLynx* Hinge is recommended for the CL33903 function, the CL33905 function and the M92 (REX) option.

### BPS Power Supply

Power supplies are designed to provide reliable filtered and regulated power for long life to a variety of electrified hardware components. All modular power supplies are voltage specific and are designed to meet UL 1481 Standards.

### Features

- Fire panel emergency release input
- PC Board mounted system LED indicator
- Voltage specific 12 or 24VDC
- Regulated and filtered with input and output protection
- Battery charging is provided from a separate output terminal

Model	Input	Output
BPS-12-1	115VAC @ 50/60 Hz	1 Amp @ 12VDC
BPS-12-3		3 Amp @ 12VDC
BPS-24-1	115VAC @ 50/60 Hz	1 Amp @ 24VDC
BPS-24-2		2 Amp @ 24VDC



Hardwiring Made Easy™

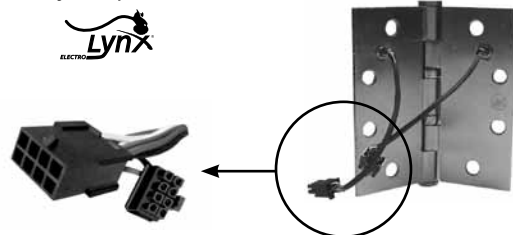



### Armstrong

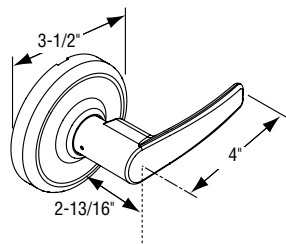

#### AZD

**Lever:** Die cast zinc  
**Rose:** Wrought brass or bronze



### Newport

Complies with codes requiring lever to return to within 1/2" (13mm) of door face.

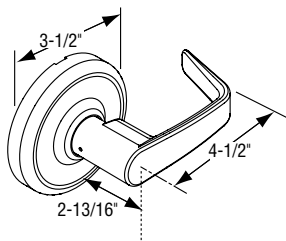

#### NZD

**Lever:** Die cast zinc  
**Rose:** Wrought brass or bronze



### Princeton

Complies with codes requiring lever to return to within 1/2" (13mm) of door face.

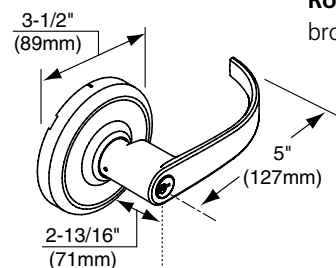

#### PZD

**Lever:** Die cast zinc  
**Rose:** Wrought brass or bronze



### Frascati

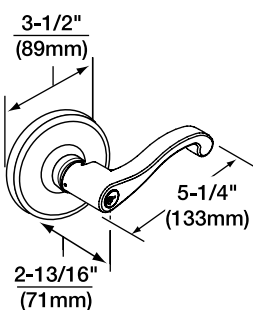

#### FZD

**Lever:** Die cast zinc  
**Rose:** Wrought brass or bronze  
Specify hand



# Options & Accessories

## CL3300

### Latches

To order optional latch with lockset, see Quick Codes, pages 16-17.  
To order latch separately, specify Part No. x Finish (e.g., 586F16 x 626).

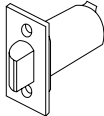
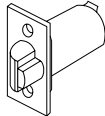
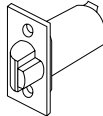
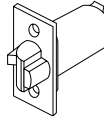
Backset and Front Description	Plain For CL3320TO, CL3310, CL3380, CL3390	Deadlocking	Throw-Off For CL3320, CL3320H, CL3329, CL3340, CL3375,CL3393	3/4" (19mm) Throw Deadlocking Fire Latch for Pair of Doors
<b>2-3/4" (70mm) Backset</b>				
Square corner front, 2-1/4" (57mm) x 1-1/8" (29mm)	586F16	586F17	586F18	601F69 (Not available for CL3320, CL3329, CL3340, CL3375, CL3393) 605, 606 and 626 finishes available
Rounded corner front, 2-1/4" (57mm) x 1-1/8" (29mm)	596F66	596F67	596F68	Not available
<b>3-3/4" (95mm) Backset</b>				
Square corner front, 2-1/4" (57mm) x 1-1/8" (29mm)	586F80	586F81	586F82	Not available
Rounded corner front, 2-1/4" (57mm) x 1-1/8" (29mm)	586F86	586F87	586F88	Not available
<b>5" (127mm) Backset</b>				
Square corner front, 2-1/4" (57mm) x 1-1/8" (29mm)	598F20	598F21	598F22	Not available
Rounded corner front, 2-1/4" (57mm) x 1-1/8" (29mm)	601F24	601F25	601F26	Not available
				

### Corbin Russwin Cylinders

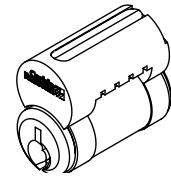
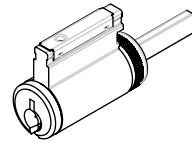

Security Type	Pins	Standard Cylinder	Interchangeable Core
Conventional	6-Pin	2000-033 (standard)	8000
	7-Pin	2000-033-7	8000-7
Hotel	6-Pin	2001-034	8001-031
	7-Pin	2001-034-7	8001-031-7
Security	6-Pin	2010-033	8010
Pyramid - High Security	7-Pin	2020-033	8020
Pyramid - Security	7-Pin	2027-033	8027
Access 3® - Patented (AP)	6-Pin	2500-033	8500
Access 3® - Security (AS)	6-Pin	2600-033	8600
Access 3® - High Security (AHS)	6-Pin	2700-033	8700
Access 3® (AP) - Hotel Function	6-Pin	2501-034	N/A
Access 3® (AS) - Hotel Function	6-Pin	2601-034	N/A
Access 3® (AHS) - Hotel Function	6-Pin	2701-034	N/A

Plug diameter for standard and Access 3® cylinders is .509, .552 for security cylinders and .496 for Pyramid cylinders.

Cylinders are brass and come with 2 nickel silver keys.

Finishes for standard cylinders include 606 or 626. Finishes for interchangeable core cylinders include 605, 606, 611, 612, 613, 625, 626.

To order cylinders separately, specify Part No. x Keyway x Finish (e.g., 2000-033 x L4 x 626).

### Cylinders with Competitive Keyways\*

Competitive Keyway	Number
Schlage® C (0-bitted)	2400-033-C
Schlage® C (keyed random)	2400-033-C-KR
Sargent® LA (0-bitted only)	2400-033-LA

\*0-Bitted cylinders are 6-pin.

### Levers That Accept Competitive Interchangeable Core Cylinders\*

Cylinder Type	Quick Code	Part Number
SFIC 6 or 7-pin Interchangeable Core	Specify M08	682F958 Tailpiece Kit
Schlage® 6-pin Interchangeable Core	Specify M69	697F942 Tailpiece Kit

\*Cylinder not included.

### Adapters Required to Accept Competitive Cylinders\*

Competitive Cylinder	Part Number
Schlage® Conventional (21-002, 23-001, 23-013) or Primus® (20-548, 20-550, 20-748, 20-750)	682F39-8 Tailpiece included with <b>M06</b> option
Sargent® 13-3266	682F96-9 Tailpiece kit and special lever included with <b>M09</b> option

\*Cylinder not included.

# Options & Accessories

## CL3300

### Strikes

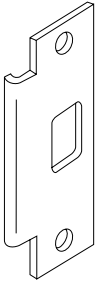

#### **ANSI Curved Lip** (standard)

Brass or stainless steel.

4-7/8" (124mm) x 1-1/4" (32mm) x 1-1/4" (32mm)  
lip to center.

Optional lip lengths: 1" (25mm), 1-1/8" (29mm),  
1-3/8" (35mm), 1-1/2" (38mm), 1-3/4" (44mm), 2"  
(51mm), 2-1/4" (57mm), 2-1/2" (64mm), 2-3/4"  
(70mm), 3" (76mm).

To order separately, specify 217L13 x  
Lip Length x Finish.

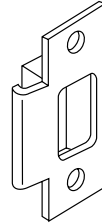

#### **Curved Lip "T" Strike**

Brass.

2-3/4" (70mm) x 1-1/8" (29mm) x 1-1/4"  
(32mm) lip to center.

Optional lip lengths: 1" (25mm),  
1-1/8" (29mm), 1-3/8" (35mm), 1-1/2" (38mm),  
1-3/4" (44mm), 2" (51mm), 2-1/4" (57mm),  
2-1/2" (64mm), 2-3/4" (70mm), 3" (76mm).

To order with lockset, see Quick Codes, page 16.

To order separately, specify 586L19 x Lip Length  
x Finish.

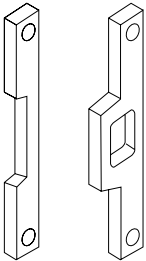

#### **Rabbeted Front and Strike**

Brass or bronze.

4" (102mm) x 5/8" (16mm) for 1/2" (13mm)  
rabbet.

No optional lip lengths.

To order with lockset, see Quick Codes,  
page 16.

To order separately, specify 601F28 x Finish.



#### **ANSI Wrought Strike Box**

To order with lockset, see Quick Codes,  
page 17.

To order separately, specify 120F76-8.

### Ordering Examples

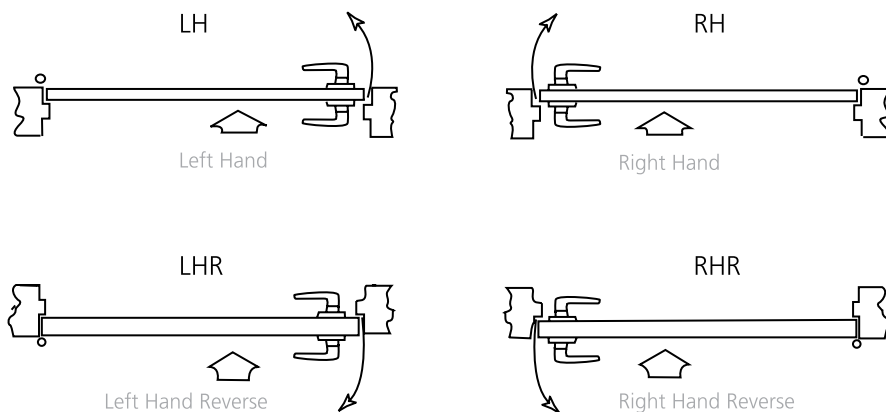

### Where to find ordering information and quick codes

Series/Function	Pages 5-7
Trim Designs	Page 11
Finish	Page 16
Door Thickness	Page 16
Backset	Page 16
Strike	Page 16
Cylinders and Keying	Page 16
Miscellaneous Options	Page 17
Electric Accessories	Page 17
Voltage	Page 17

### Stock Order

Quantity	Series/Function	Trim	Finish	Hand
100	CL3355	NZD	626	RHR

### Split Trim / Finish Order

Quantity	Series/Function	Trim		Finish		Hand
		Outside	Inside	Outside	Inside	
12	CL3355	NZD	AZD	626	625	LH

### Contract / Detailed Order

Quantity	Keypad	Series/Function	Trim	Finish	Hand	Door Thickness	Backset	Optional Strike	Misc. Options	Optional Cylinder	Keying
24	AA1	CL3355	NZD	626	RHR	D214	B334	SC114	M04-M16	C6	VK3

### Electrified CL33900 Series

Quantity	Series/Function	Trim	Finish	Hand	Voltage
6	CL33903	AZD	626	RH	12AD

# Quick Codes

## CL3300

### Cylinder and Keying

Description	Specify
Conventional 6-pin	(standard)
Conventional 7-pin	7P
Less cylinder(s)	LC
IC 6-pin	C6
IC 6-pin with Temporary Construction Core (Red)	CT6R
IC 6-pin with Temporary Construction Core (Blue)	CT6B
IC 6-pin with Temporary Construction Core (Green)	CT6G
IC 6-pin with temporary construction core	CT6
IC 6-pin less core <sup>3</sup>	CL6
SFIC 6- or 7-pin Small Format Disposable Core (NZD & PZD only)	CTSD
IC 7-pin	C7
IC 7-pin with temporary construction core	CT7
IC 7-pin less core <sup>3</sup>	CL7
IC 7-pin with Temporary Construction Core (Red)	CT7R
IC 7-pin with Temporary Construction Core (Blue)	CT7B
IC 7-pin with Temporary Construction Core (Green)	CT7G
Security <sup>3</sup>	HS
Security IC <sup>3</sup>	CHS
Access 3 <sup>®</sup> Patented Fixed Core	AP
Access 3 <sup>®</sup> Security Fixed Core	AS
Access 3 <sup>®</sup> High Security Fixed Core	AHS
Access 3 <sup>®</sup> Patented IC <sup>3</sup>	ACP
Access 3 <sup>®</sup> Security IC <sup>3</sup>	ACS
Access 3 <sup>®</sup> High Security IC <sup>3</sup>	ACHS
Pyramid High Security Fixed Core <sup>3</sup>	PHS
Pyramid High Security IC <sup>3</sup>	PCHS
Pyramid IC Less Core <sup>3</sup>	CLP
Pyramid with temporary construction core <sup>3</sup>	CTP
Pyramid Security Fixed Core <sup>3</sup>	PS
Pyramid Security IC <sup>3</sup>	PCS
Pyramid Disposable Core <sup>3</sup>	CTPD
6-Pin Disposable Core <sup>3</sup>	CT6D
7-Pin Disposable Core <sup>3</sup>	CT7D
0-bitted with 2 blank keys	(standard)
Keyed random	KR
Construction master keyed	CMK
Visual key control (VKC)	
No bitting or keyset stamping on keys	VKC0
Keys only	VKC1
Cylinders and keys (not for HS, CHS, PHS or PCHS)	VKC2
Cylinders only (not for HS, CHS, PHS or PCHS)	VKC3
Concealed key control (CKC)	
CKC cylinders with VKC keys	CKC2
CKC cylinders only (not for PHS, PCHS)	CKC3
2 keys per lock	(standard)
More than 2 keys	KY# (e.g., KY6)
Schlage <sup>®</sup> C keyway cylinder <sup>1,3</sup>	C
Sargent <sup>®</sup> LA keyway cylinder <sup>2,3</sup>	LA

1 Available 0-bitted & keyed random (KR) only

2 Available 0-bitted only

3 Not available in CL3329 functions

### Finishes

Description	Specify
ANSI/BHMA 605 (US3) Bright Brass	605
ANSI/BHMA 606 (US4) Satin Brass	606
ANSI/BHMA 611 (US9) Bright Bronze	611
ANSI/BHMA 612 (US10) Satin Bronze	612
ANSI/BHMA 613 (US10B) Dark Oxidized Satin Bronze, Oil Rubbed	613
613E Dark Oxidized Satin Bronze - equivalent	613E
613L Dark Oxidized Satin Bronze, Clear Coated	613L
ANSI/BHMA 618 (US14) Bright Nickel Plated	618
ANSI/BHMA 619 (US15) Satin Nickel Plated	619
ANSI/BHMA 625 (US26) Bright Chromium Plated	625
619C Satin Nickel Plated with MicroShield <sup>®</sup>	619C
ANSI/BHMA 626 (US26D) Satin Chromium Plated	626
626C Satin Chromium Plated with MicroShield <sup>®</sup>	626C
ANSI/BHMA 722 Black Oxidized Bronze, Oil Rubbed	722

Zinc levers are plated to match BHMA finish.

### Strikes

ANSI Lip to Center	ANSI Curved Lip Specify	T-Strike Curved Lip Box Specify
1" (25mm)	SA100	SC100
1-1/8" (29mm)	SA118	SC118
1-1/4" (32mm)	(standard)	SC114
1-3/8" (35mm)	SA138	SC138
1-1/2" (38mm)	SA112	SC112
1-3/4" (44mm)	SA134	SC134
2" (51mm)	SA200	SC200
2-1/4" (57mm)	SA214	SC214
2-1/2" (64mm)	SA212	SC212
2-3/4" (70mm)	SA234	SC234
3" (76mm)	SA300	SC300
Rabbeted front and strike		Specify SR118



### Door Thickness

Door Thickness	Specify
1-3/4" (44mm) - 2" (51mm)	(standard)
Over 2" (51mm) - 2-1/4" (57mm)	D214

### Backset

Description	Specify
2-3/4" (70mm)	(standard)
3-3/4" (95mm)	B334
5" (127mm)	B500

### Miscellaneous Options

Description	Specify
Spanner head screws	M02
Torx® head screws	M04
Less cylinder, with tailpiece for Schlage® cylinder	M06*
Lever to accept SFIC 6 or 7-pin interchangeable core (NZA & PZD design only)	M08*
Lever to accept Sargent® cylinder (NZA & PZD designs only)	M09*
Lever to accept Schlage® Interchangeable core (NZA & PZD design only)	M69*
Rounded corners on latch front	M13
3/4" (19mm) throw fire latch	M16
ANSI wrought strike box	M17
Knurling outside and inside	M20
Knurling outside only	M21
Knurling inside only	M22
Abrasive coat outside and inside	M23
Abrasive coat inside only	M24
Abrasive coat outside only	M25
Lead lining (roses)	M28
Request to Exit (REX) Switch (CL33900 only)	M92

\*Not available in CL3329 functions

### Electric Accessories

Description	Part Number
Power supply 1.0 Amp @ 12 VDC output	BPS-12-1
Power supply 3.0 Amp @ 12 VDC output	BPS-12-3
Power supply 1.0 Amp @ 24 VDC output	BPS-24-1
Power supply 2.0 Amp @ 24 VDC output	BPS-24-2

### Voltage Options

Description	Specify
12 volt alternating current/direct current	12AD
24 volt alternating current/direct current	24AD

# How To Specify

## CL3300

### CL3300 Series Suggested Specification

All locksets shall be CL3300 Series Extra Heavy Duty Cylindrical Lever Locksets as manufactured by Corbin Russwin Architectural Hardware.

A single lock chassis shall accommodate 1-3/4" (44mm) to 2-1/4" (57mm) door thickness. Locksets shall be non-handed. Locksets shall have separate anti-rotation throughbolts, and shall have no exposed mounting screws.

Locksets shall have solid cast levers without plastic inserts. Levers shall operate independently, and shall have separate inside and outside lever return springs to prevent lever sag. Outside lever handles shall be a minimum of 4-5/8" (117mm) in length and shall provide a minimum of 2" (51mm) clearance from the surface of the door to the inside of the lever at the midpoint. Outside lever handles may return to within 1/2" (13mm) of the door surface. Levers on keyed locksets shall be removable only when the designated key is in the cylinder.

When the outside lever is locked, it shall rotate freely and it shall return to its horizontal position when released.

A single lockset shall accommodate 6 or 7-pin conventional cylinders and all levels of master keying, construction master keying, visual key control, security, high security and interchangeable core. Cylinders may be easily changed by removing the lever without disassembling the lockset.

A 3/4" (19mm) throw latchbolt for pairs of fire doors shall be available. All locksets with a 1/2" (13mm) throw latchbolt shall be listed by Underwriters Laboratories for A label and lesser class single doors, 4' x 10'. All locksets with 3/4" (19mm) throw latchbolt shall be UL listed for A label and lesser class pairs of doors, 8' x 10'.

Certification:

Federal Specification FF-H-106C

ANSI/BHMA A156.2 Series 4000, Grade 1

ANSI A117.1 Accessibility Code

California State Reference Code (formerly Title 19, California State Fire Marshal Standard).

Locksets shall carry a seven-year limited warranty.

### **CL33900 Electrified Series Suggested Specification**

All locksets shall be CL33900 Series Extra Heavy Duty Cylindrical Lever Locksets as manufactured by Corbin Russwin Architectural Hardware.

A single lock chassis shall accommodate 1-3/4" (44mm) to 2-1/4" (57mm) door thickness. Locksets shall be non-handed. Locksets shall have separate anti-rotation throughbolts, and shall have no exposed mounting screws.

Locksets shall have solid cast levers without plastic inserts. Levers shall operate independently, and shall have separate inside and outside lever return springs to prevent lever sag. Outside lever handles shall be a minimum of 4-5/8" (117mm) in length and shall provide a minimum of 2" (51mm) clearance from the surface of the door to the inside of the lever at the midpoint. Outside lever handles may return to within 1/2" (13mm) of the door surface. Levers on keyed locksets shall be removable only when the designated key is in the cylinder.

When the outside lever is locked, it shall rotate freely and it shall return to its horizontal position when released.

The CL33900 Series shall be available 12 or 24 volt AC and DC (rectifier to be included) and Fail Safe or Fail Secure. The locking solenoid shall be continuous duty and self-contained in the lock chassis.

A single lockset shall accommodate 6 or 7-pin conventional cylinders and all levels of master keying, construction master keying, visual key control, security, high security and interchangeable core. Cylinders may be easily changed by removing the lever without disassembling the lockset.

A 3/4" (19mm) throw latchbolt for pairs of fire doors shall be available. All locksets with a 1/2" (13mm) throw latchbolt shall be listed by Underwriters Laboratories for A label and lesser class single doors, 4' x 10'. All locksets with 3/4" (19mm) throw latchbolt shall be UL listed for A label and lesser class pairs of doors, 8' x 10'.

#### Certification:

Federal Specification FF-H-106C

ANSI/BHMA A156.2 Series 4000, Grade 1

ANSI A117.1 Accessibility Code

California State Reference Code (formerly Title 19, California State Fire Marshal Standard)

Electrified locksets shall carry a two-year limited warranty.

ASSA ABLOY is the global leader in door opening solutions, dedicated to satisfying end-user needs for security, safety and convenience



**ASSA ABLOY**

**In U.S.**

Corbin Russwin  
Architectural Hardware  
225 Episcopal Road  
Berlin, CT 06037  
Phone: 800-543-3658  
Fax: 800-447-6714  
corbinrusswin.com

**In Canada**

ASSA ABLOY Door  
Security Solutions Canada  
160 Four Valley Drive  
Vaughan, Ontario  
Canada L4K 4T9  
Phone: 800-461-3007  
Fax: 905-738-2478  
www.assaabloy.ca

For more information regarding Corbin Russwin Locksets, Exit Devices, Door Controls and Key Systems, contact your authorized Corbin Russwin Distributor or Sales Representative.



**MicroShield®**

As part of their promise to provide innovative solutions to their customers, certain ASSA ABLOY Group brands offer the MicroShield® technology, a silver-based antimicrobial coating designed to inhibit the growth of bacteria.

MicroShield® is a registered trademark of Yale Security Inc., an ASSA ABLOY Group company.

Hardwiring Made Easy™



**ElectroLynx®**

As part of their promise to provide innovative, fast and effective high security solutions to their customers, certain ASSA ABLOY Group brands offer ElectroLynx®, a universal quick-connect system that simplifies the electrification of the door opening.

ElectroLynx® is a registered trademark of ASSA ABLOY Inc.

Corbin Russwin and Design® and Access 3® are registered trademarks of Corbin Russwin, Inc., an ASSA ABLOY Group company. Lever Release™ is a trademark of Corbin Russwin, Inc., an ASSA ABLOY Group company. Other products' brand names may be trademarks or registered trademarks of their respective owners and are mentioned for reference purposes only. These materials are protected under US copyright laws. All contents current at time of publication. Corbin Russwin, Inc., an ASSA ABLOY Group Company, reserves the right to change availability of any item in this catalog, its design, construction, and/or its materials. Copyright © 2003, 2015 Corbin Russwin, Inc., an ASSA ABLOY Group company. All rights reserved. Reproduction in whole or in part without the express written permission of Corbin Russwin, Inc. is prohibited.