

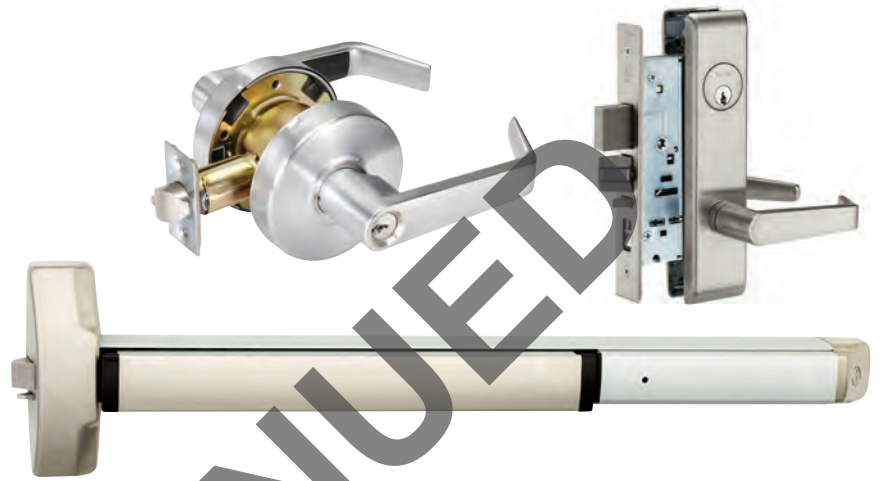

Full Line Catalog



ACCENTRA

ASSA ABLOY

This product is now proudly being offered under the ASSA ABLOY ACCENTRA™ brand, effective June 20, 2023.

Visit [YaleCommercial.com/en/Today](https://www.yalecommercial.com/en/Today) for support and information.



Cylinders/Keys

Cylinders and Keying Manual



Table of Contents



Contents

Finishes & How to Order	2
Yale® KeyMark® and KeyWizard®	3
Cylinder and Key Stamping	4
Special Features	
Construction Master Keying	5
Interchangeable Core	5
Bump Resistant	6
Hotel Function	6
Security/High Security	7
Cylinder Types	
Mortise	8-10
Rim	11-13
Component	14-17
Interchangeable Core	18
Key Blanks	19-20
Keyways	21
Cams	22
Collars	23
Service Equipment, Parts, Dust Shields	24-27
Pinning Specifications	28-29
Policies and Procedures	30
Designing Master Key Systems	31
How to Establish Key Systems	32-34

How To Order Cylinders

When ordering cylinders separately, the following details should be specified. Cylinders ordered with Yale products will be provided to accommodate those products. Detailed information can also be found in the individual product catalogs.

Model #	Length	Cam	Collar	No. of Pins	Keyway	Finish
2153	1-1/8"	2160	1765.250	6	GA	626

How To Order KeyWizard®

All KeyWizard programs are licensed specifically to each facility end user. Special online ordering procedures apply. The following information is required for each system:

- End user facility name
- End user contact person
- Mailing address
- Phone number

Cylinders/Keys

Today's facilities require flexible options when it comes to security. Thanks to recent technological changes in the security industry, modern commercial buildings have a variety of choices of how access to each opening is controlled. Mechanical key cylinders continue to provide strong traditional security, but many facilities favor a combination of mechanical and electronic security products for convenient access with an audit trail.

Yale offers a range of cylinder options, including conventional, interchangeable core, security, high security and Yale KeyMark®. Providing an array of cylinders, keys and keying systems that meet the needs of any facility, Yale Works for YouSM.

Finishes

ANSI/BHMA Code	Finish Description
605	Bright Brass, Clear Coated
606	Satin Brass, Clear Coated
609	Satin Brass, Blackened, Satin Relieved, Clear Coated
611	Bright Bronze, Clear Coated
612	Satin Bronze, Clear Coated
613E	Dark Oxidized Satin Bronze - equivalent
616	Satin Bronze, Blackened, and Satin Relieved, Clear Coated
618	Bright Nickel Plated, Clear Coated
619	Satin Nickel Plated, Clear Coated
620	Satin Nickel Plated, Blackened, Satin Relieved, Clear Coated
625	Bright Chrome Plated
626	Satin Chrome Plated
629	Bright Stainless Steel
630	Satin Stainless Steel
693	Black Painted
BSP	Black Suede Powder Coat
WSP	White Suede Powder Coat

Notes:

- Rim cylinders not available in 629 or 630 finishes.
- Component plugs only provided in 606 and 626

Certified ANSI/BHMA A156.5, Grade 1



Yale® KeyMark® and KeyWizard®



Yale® KeyMark®

Yale® KeyMark® protected keyway line of cylinders feature an angled keyway designed to accept any keyblank constructed with the same angle, allowing all key formats to be tied to the same master key system. Security Leg® prohibits other manufacturers' keys from entering the cylinder, prevents unauthorized duplication of keys and offers increased picking resistance against intruders. Cylinders include mortise, rim, component, auxiliary, and interchangeable core. Interchangeable core is available in both large and small format. For more information and details on Yale KeyMark cylinders please refer to separate catalog section.



KeyWizard®

A key management software program is essential for any type of organization. Keeping track of the key holders in a master key system is critical for maintaining key control and ensuring the security and integrity of the system.



KeyWizard by Yale® is a comprehensive key management software program was designed for facility end users to track detailed information concerning their keying system. It offers improvements over existing key management software by utilizing clutter-free and easily navigated screens.

KeyWizard by Yale provides the facility with accurate information concerning keys, key holders, hardware locations, master key systems, overdue keys and maintenance service schedules, all of which can be customized.

For more information about KeyWizard® including demo versions, please visit www.yalelocks.com or www.keywizard.net. For KeyWizard technical support, please call 1-800-610-1706.

Cylinders and Key Stamping



Keys and/or cylinders stamped with their respective keyset symbols allows for easy identification and will reduce the chance of confusion between cylinders, keys and the lockset during and after installation. The information on the cylinder allows for easy identification of the levels of security within that particular cylinder.

Visual Key Control (VKC)

For convenience, specify VKC and the key symbol is stamped on the plug face or other visible portion of the front of the cylinder. (VKC is available on all keys, but not available on security, high security or Yale® KeyMark® cylinders.)

Concealed Key Control (CKC)

For greater security, specify CKC on the cylinders. The key symbol is stamped in a concealed location, such as the rear of the cylinder. It is not visible to the general occupants of the building but can be accessed by authorized personnel upon removing the cylinder from the lockset.

For example, the symbol AA1 shown in the illustration identifies the lock to be operated by grand master key A, master key AA and change key AA1. Upon written authorization from the building owner to an authorized Yale® Distributor, a bitting list can be supplied for each job to translate the symbols into key bittings.

If a key is lost, it can easily be replaced by referring to the symbol on the cylinder and the bitting on the bitting list. VKC is not available on security, high security or Yale® KeyMark® cylinders.

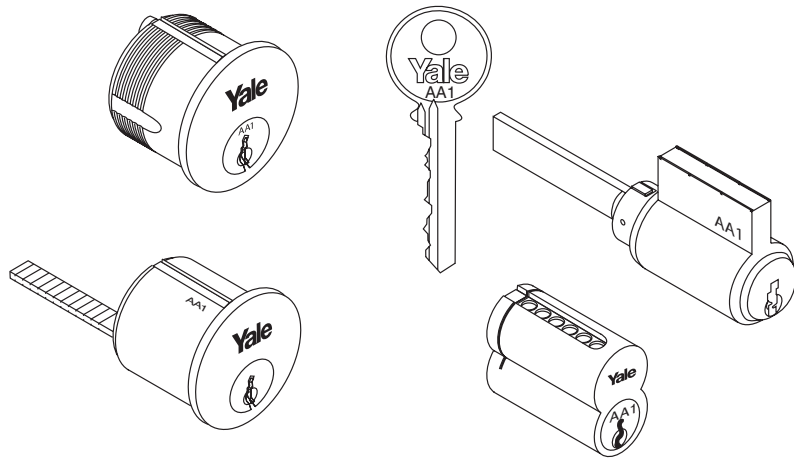

Key Stamping Code Definitions

Code	Definition
VKC0	No keyset, registry number, or bitting stamping any keys. Includes master keys and change keys. Keys will be stamped with keyway designation. (Keys will be tagged.)
VKC1	Master keys stamped with their keyset symbol and registry number. Change keys stamped with their keyset symbol (Standard for high security, security and Yale® KeyMark® cylinders.)
VKC2	Master keys stamped with their keyset symbol and registry number. Change keys stamped with their keyset symbol. Cylinders stamped with their keyset symbol on the face of the plug. (Not available for high security cylinders, security cylinders or Yale KeyMark.)
VKC3	Master keys stamped with their keyset symbol and registry number. Change keys stamped with their bitting. Cylinders stamped with their keyset symbol on the face of the plug. (Not available for high security cylinders, security cylinders or Yale KeyMark.)
CKC2	Master keys stamped with their keyset symbol and registry number. Change keys stamped with their keyset symbol. Cylinders stamped with their keyset symbol in a concealed location.
CKC3	Master keys stamped with their keyset symbol and registry number. Change keys stamped with their bitting. Cylinders stamped with their keyset symbol in a concealed location. (Not available for high security cylinders, security cylinders or Yale KeyMark.)

Special Features



Construction Master Keying

Construction Master Keying (CMK) provides the extra security needed in the transition from construction of a building or complex to completion. The construction master key operates all cylinders during construction. Upon completion of the construction phase, a special break out key is used in each cylinder to permanently void the construction master key. This action eliminates further use of the construction master or break out key.

How it Works

Yale construction keying is accomplished by the placement of a ball bearing between the bottom pin and the top pin in one of the chambers. While the ball bearing is in place the construction master key will operate the cylinder. Removing the ball bearing, by use of the special break out key, voids the use of the construction master key. For all standard cylinders, the breakout key is rotated approximately 120 degrees either clockwise or counter-clockwise and the ball bearing is lost through a pre-drilled hole in the cylinder shell.

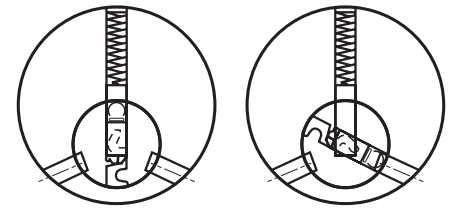

With CBOK inserted

Turning CBOK Releases Ball-Bearing

SKD Caution

Unless otherwise specified, SKD sets will be construction master keyed. When construction master keying is established for SKD sets, Yale issues a separate SKD construction master keys and construction break out keys.

Temporary Construction Cores

A more secure method of construction keying for interchangeable core hardware is the use of temporary construction cores. Yale recommends this method of construction keying for key systems using interchangeable core cylinders. Construction cores are furnished keyed alike to a combination unrelated to the permanent system's master key. When the building is turned over to the owner, the permanent cores are installed and the temporary construction cores are returned to Yale for credit.

How to Order CMK

To order locksets and/or cylinders with the construction master key feature, the option code **CMK** should be indicated. i.e. 2153 x CMK. Construction master keying is not available on security, high security or Yale® KeyMark® cylinders.

The permanent master and change keys for the system are always packed and shipped separately, and the order must include the names and addresses of individuals to whom the construction, permanent master and change keys should be sent.

To order locksets and/or cylinders with temporary construction cores, specify "x Temp Core" when ordering. i.e. 2196 x Temp Core.

Interchangeable Core

Yale offers interchangeable core cylinders which are recommended for virtually all types of keying systems, such as office buildings, hotels, schools, hospitals and universities. These cylinders have a 'self-contained' core which is removed from the housing by a control key. The core can be replaced or re-keyed without removing the hardware from the door or disassembling the lock. For conventional and security cylinders, Yale offers large format interchangeable cores which can be integrated with standard cylinder formats within the same key system. For Yale® KeyMark® systems, large format and small format cores are available and can be keyed within the same key system. Yale also offers small format cores and master keying with Best® keyways (see page 18).



To order interchangeable core cylinders with locksets, specify by cylinder or core model number. i.e. AUR8807FL x RH x **2196** x 626 or AU5407LN x RH x **1210** x 626. Unless otherwise specified, conventional fixed core cylinders will be provided as standard with locksets.

Large format cores are available construction master keyed, although temporary cores are recommended. To void the construction master key, the core must first be removed from the housing and then operated by the breakout key to remove the ball bearing.

Special Features



Bump Resistant

Bumping, also called "rapping," has been a known lock picking technique for more than 50 years. This technique uses a specially cut key, which when inserted into a cylinder and then hit with a mallet or tool, forces the key to interact with the pins. This motion allows a separation between the pins which creates a "shear" line and enables the key to be turned and the lock to be opened.

Conventional cylinders in both fixed and interchangeable core formats are available to be constructed to withstand bumping. These cylinders will contain a patent pending pinning component that is designed to resist bumping attacks while maintaining cylinder functionality. Bump resistant cylinders provide an added line of defense against unauthorized entry.

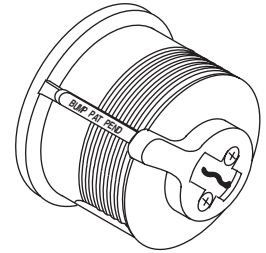

The bump resistant feature is available as an option for conventional mortise, rim and component cylinders with Yale® keyways. Fixed and interchangeable core cylinders can be provided in either in 6- or 7-pin lengths. This option is not available for security, high security or Yale® KeyMark® cylinders at this time.

How to Order

To order with cylinders, specify option **BUMP**. (Cylinders will be marked with "BUMP PAT PEND" on the pin cover.)

Retrofit pins are also available to convert existing cylinders to bump resistant cylinders. Order by specifying **751-3**. A vial with a quantity of 300 pins is provided which will allow the retrofit of approximately 50 cylinders (6-pin). The vial easily fits into the SK-12 pin kit.

The Yale .019" pinning specification will change for cylinders with the BUMP option. Cylinders will be combined with a special 3 (.190") top (driver) pin in each chamber. Please see page 29 for Bump pinning specification.

Hotel Function

Although not widely used in today's hotels, the hotel function lock still has several applications. In most cases, these locks are mixed with other lock functions on the same keying system.

When ordering a factory keyed lock system that includes Yale hotel function locks ALL cylinders in the system will need to be 7-pin in length with 7-pin keys. This applies even though the master key system will be 6-pin for expansion purposes.

How it Works

The hotel function cylinder contains a blocking screw where the 7th pin is normally located. When the deadbolt is thrown on the hotel function lock, the blocking screw is engaged, thus blocking all change keys and master keys from operating the cylinder. Only the emergency key (EMK), which is cut on a shorter key blank with an undercut tip, will override the deadbolt thus operating the cylinder.

The change keys and master keys that operate the hotel function cylinder when the deadbolt is retracted are cut on key blanks with an undercut tip to bypass the blocking screw.

The hotel function lock may be operated by a grand master key or master key that also operates other cylinders in the system. Therefore, the other product must be 7-pin to accommodate these top master keys.

Keyblanks

The following keyblanks are required when using hotel function locks/cylinders mixed with other function hardware:

- RN411** = Change key and top master keys that would operate hotel function cylinder
- RN117** = All other change keys and master keys in the system
- RN411S** = Emergency key
- FN118C** = Control key (if interchangeable core)



Security and High Security

Security cylinders contain two independent locking mechanisms. The first is a traditional 6- or 7-pin tumbler mechanism with spool drivers for greater pick resistance. The second is an innovative rotating disc mechanism with sidebar engagement. The rotating discs are spring loaded and block the bottom of the keyway. Only a specially cut key will move the discs and allow entrance of the key. This key has special side bittings and must align all discs perfectly before the cylinder plug will rotate to open the lock. This cylinder is highly pick resistant because the unlocking mechanisms must be activated in two directions.

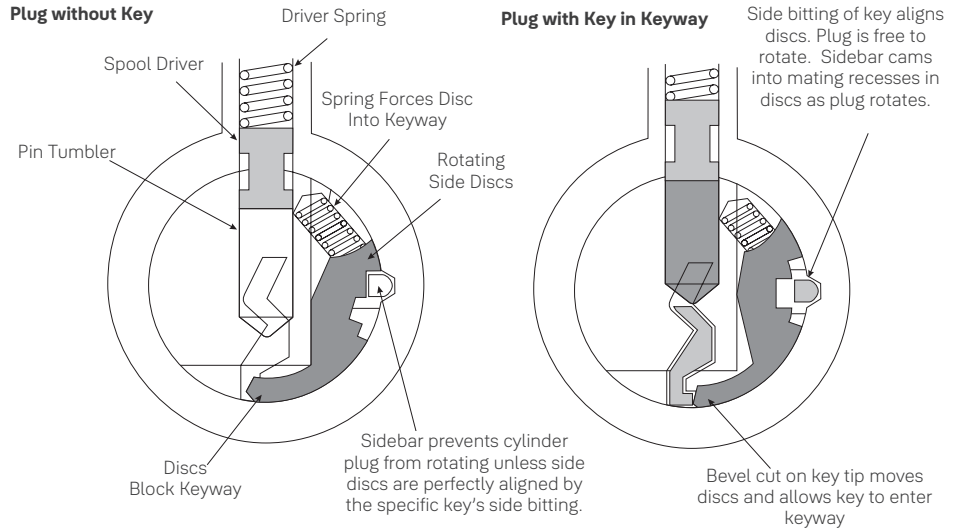

UL High Security Cylinders

For applications that require a high security cylinder to meet the requirements of UL 437 for pick and drill resistance, Yale offers the U5153 mortise cylinder and the U5109 rim cylinder. These cylinders have a hardened stainless steel cylinder head and rotating plug face. They also incorporate all the features listed for the standard security cylinders. U5109 and U5153 cylinders use the 1766 cylinder collar, see page 23 for more information.

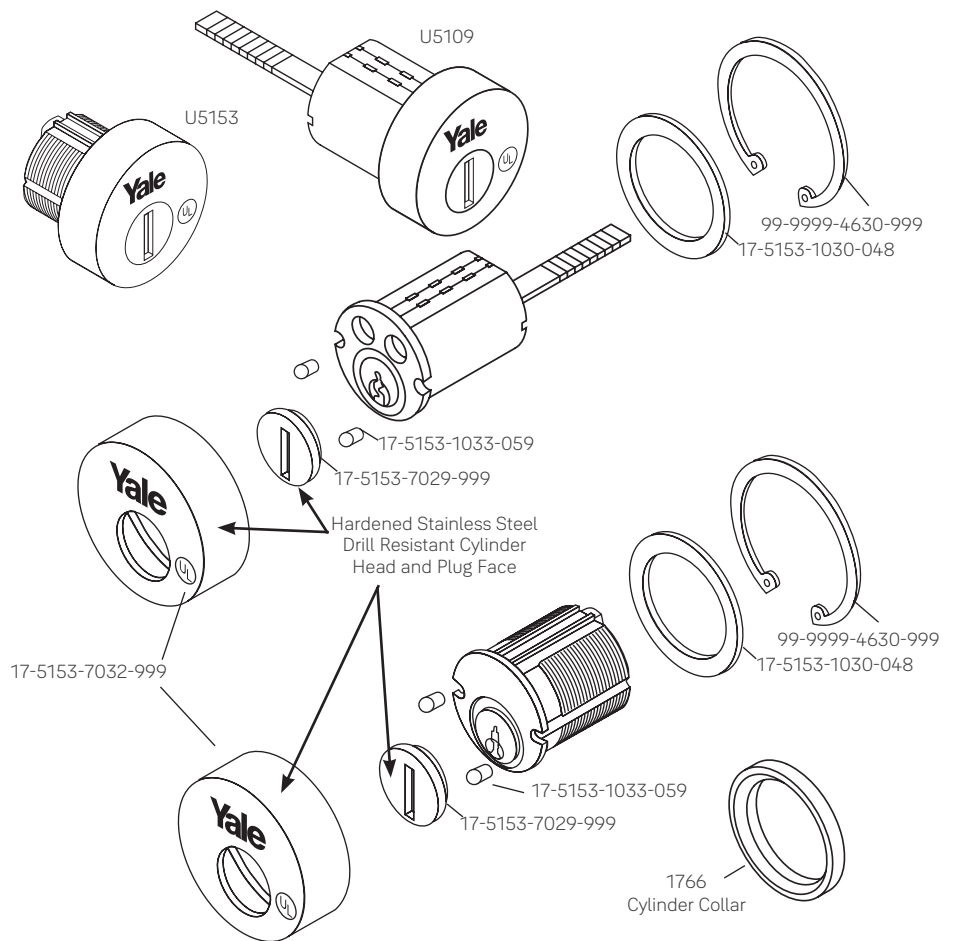

Mortise Cylinders



Fixed Core For Current Products

Includes standard, hotel, security and high security for mortise and auxiliary applications. Stock cylinders are furnished 1-1/8" length and 6-pin keyed random. Unless otherwise specified, stock cylinders ordered separately will be provided with cylinder collar 1765.156. If another collar size is required, specify when ordering. Refer to individual product sections for collar applications and sizes.



Mortise cylinders are provided standard with cams to operate Yale® mortise locks, optional cams are available (see page 22).

Model #	Description	Lengths				Cam	
		5-Pin	6-Pin		7-Pin		
2153	Standard cylinder	1" (25)	1-1/8" (29) 1-1/4" (32) 1-3/8" (35)	1-1/2" (38) 1-5/8" (41) 1-3/4" (44)	1-1/4" (32) 1-3/8" (35) 1-1/2" (38)	1-5/8" (41) 1-3/4" (44)	2160
2153S	Standard cylinder for inside operation of 8817-2 and 8834-2 functions only	1" (25)	1-1/8" (29) 1-1/4" (32) 1-3/8" (35)	1-1/2" (38) 1-5/8" (41) 1-3/4" (44)	1-1/4" (32) 1-3/8" (35) 1-1/2" (38)	1-5/8" (41) 1-3/4" (44)	2130
2123	Same as 2153 with long lengths for thicker doors	--	1-7/8" (48) 2-1/8" (54) 2-1/4" (57)	2-3/8" (60) 2-1/2" (64) 2-5/8" (67) 2-3/4" (70)	2-7/8" (73) 3" (76) 3-1/8" (79)	3-3/8" (86) 3-1/4" (83) 3-1/2" (89)	2160
2123S	Same as 2153S with long lengths for thicker doors	--					2130
2719*	Standard cylinder for Hotel/Motel functions 8820, 8827, and 8832	--	1-3/8" (35)		--		2160
S2053S	Thumbturn cylinder for inside operation of 8834 function	1" (25)	1-1/8" (29)		--		2130
S2053	Thumbturn operated cylinder to replace key operated cylinder	1" (25)	1-1/8" (29)		--		2160
1108	Dummy mortise cylinder	1" (25)	1-1/8" (29) 1-1/4" (32) 1-3/8" (35)	1-1/2" (38) 1-5/8" (41) 1-3/4" (44)	1-1/4" (32) 1-3/8" (35) 1-1/2" (38)	1-5/8" (41) 1-3/4" (44)	N/A
5153	Security cylinder	--	1-1/8" (29) 1-1/4" (32)		1-1/4" (32)		2160
5153S	Security cylinder for inside operation of 8817-2 and 8834-2 functions only	--	1-1/8" (29) 1-1/4" (32)		1-1/4" (32)		2130
5719*	Security cylinder for Hotel/Motel functions 8820, 8827, and 8832	--	1-3/8" (35)		--		2160
U5153	High security cylinder	--	1-1/8" (29) 1-1/4" (32)		1-1/4" (32)		2160
U5719*	High security cylinder for Hotel/Motel functions 8820, 8827, and 8832	--	1-3/8" (35)		--		2160
2553^	Schlage® "C" keyway cylinder 0-bitted or keyed random	--	1-1/8" (29)		--		2160

*Cylinders are 6-pin for master keying expansion purposes. Locksets and housings will be 7-pin in length to accommodate top level master keys. See page 6 for more information.

^Available in 606, 612, 613 and 626 finishes only.

Dimensions are shown in inches (millimeters)



Mortise Cylinders

Fixed Core For Obsolete Products

The following fixed core cylinders are available for obsolete Yale® mortise products.

Model #	Description	Lengths			Cam
		5-Pin	6-Pin	7-Pin	
1152	Standard cylinder for obsolete cast iron mortise locks	1" (25)	1-1/8" (29) 1-1/2" (38) 1-1/4" (32) 1-5/8" (41) 1-3/8" (35) 1-3/4" (44)	1-1/4" (32) 1-5/8" (41) 1-3/8" (35) 1-3/4" (44) 1-1/2" (38)	1161
1719*	Standard cylinder for obsolete Hotel/Motel cast iron locks	--	1-3/8" (35)	--	1160
5152	Security cylinder for obsolete cast iron mortise locks	--	1-1/8" (29) 1-1/4" (32)	1-1/4" (32)	1161
U5152	High security cylinder for obsolete cast iron mortise locks	--	1-1/8" (29) 1-1/4" (32)	1-1/4" (32)	1161

*Cylinders are 6-pin for master keying expansion purposes. Locksets and housings will be 7-pin in length to accommodate top level master keys. See page 6 for more information.

Dimensions

Standard Cylinders

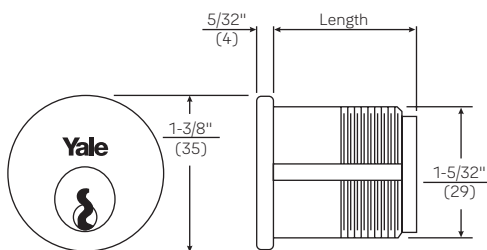

Thumbturn Cylinders

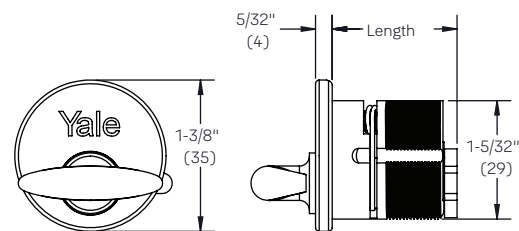

Security Cylinders

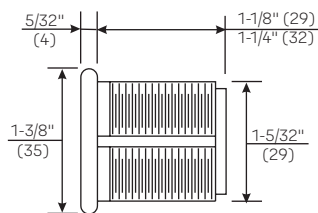

High Security Cylinders

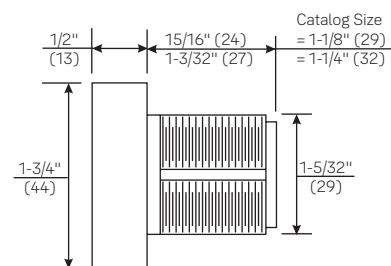

Dimensions are shown in inches (millimeters)

Mortise Cylinders



Large Format Interchangeable Core (LFIC) For Current Products

Includes standard, hotel, security and high security large format interchangeable core for mortise and auxiliary applications. When ordering interchangeable core cylinders or cores only, control keys are not furnished. If control keys are required, they must be specified.



Model Numbers			Description	Lengths		Cam
Complete Cylinder	Core Only	Housing Only		6-Pin	7-Pin	
2196	1210	2221	Standard cylinder	1-1/2" (38) 1-3/4" (44) 2" (51)	--	2160
2196S	1210	2214S	Standard cylinder for inside operation of 8817-2 and 8834-2 functions only	1-1/2" (38)	--	2130
2196H*	1210H	2213	Standard cylinder for Hotel/Motel functions 8820, 8827, and 8832	1-11/16" (43)	--	2160
2197	1220	2213	Standard cylinder	--	1-11/16" (43) 2" (51)	2160
2197S	1220	2217S	Standard cylinder for inside operation of 8817-2 and 8834-2 functions only	--	1-11/16" (43)	2130
5196	5210	2221	Security cylinder	1-1/2" (38) 1-3/4" (44) 2" (51)	--	2160
5196S	5210	2214S	Security cylinder for inside operation of 8817-2 and 8834-2 functions only	1-1/2" (38)	--	2130
5196H*	5210H	2213	Security cylinder for Hotel/Motel functions 8820, 8827, and 8832	1-11/16" (43)	--	2160
5197	5220	2213	Security cylinder	--	1-11/16" (43) 2" (51)	2160
5197S	5220	2217S	Security cylinder for inside operation of 8817-2 and 8834-2 functions only	--	1-11/16" (43)	2130

*Cores are 6-pin for master keying expansion purposes. Locksets and housings will be 7-pin in length to accommodate top level master keys. See page 6 for more information.

Large Format Interchangeable Core (LFIC) For Obsolete Products

The following LFIC cylinders are available for obsolete or discontinued Yale® mortise products.

Model Numbers			Description	Lengths		Cam
Complete Cylinder	Core Only	Housing Only		6-Pin	7-Pin	
1194	1210	1214	Standard cylinder for obsolete cast iron mortise locks	1-1/2" (38)	--	1160E
1194	1220	1214H	Standard cylinder for obsolete cast iron mortise locks	--	1-11/16" (43)	1160E
1194H*	1210H	1214H	Standard cylinder for obsolete Hotel/Motel cast iron locks	1-11/16" (43)	--	1160E
1196	1210	1221	Standard cylinder for discontinued 310 series deadlocks	1-1/2" (38)	--	1160R
1196	1220	1213	Standard cylinder for discontinued 310 series deadlocks	--	1-11/16" (43)	1160R
1196H*	1210H	1213	Standard cylinder for obsolete hotel 310 series deadlocks	1-11/16" (43)	--	1160R
5194	5210	1214	Security cylinder for obsolete cast iron mortise locks	1-1/2" (38)	--	1160E
5194	5220	1214H	Security cylinder for obsolete cast iron mortise locks	--	1-11/16" (43)	1160E

*Cores are 6-pin for master keying expansion purposes. Locksets and housings will be 7-pin in length to accommodate top level master keys. See page 6 for more information.

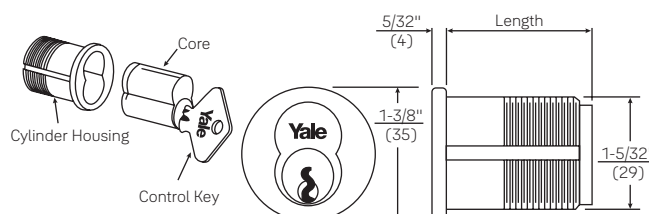

Dimensions are shown in inches (millimeters)

Rim Cylinders



Fixed Core For Current Products

Includes standard, hotel, security and high security for rim lock and exit device trim applications. When ordered with products, cylinders are provided with applicable tailpiece and collar. Cylinders ordered separately are provided with backplate and screws standard. Tailpiece must be specified. If required, collar must be specified. Refer to individual product sections for collar applications and sizes.



Model #	Description	No. of Active Pins	Dim A	Dim B	Dim C Tailpiece Model Numbers	
					#1145	#1147
1109	Standard cylinder	5	1-1/32" (26)	15/16" (24)	2-9/16" (65)	3-7/16" (87)
		6	1-7/32" (31)	1-3/32" (28)	2-3/4" (70)	3-5/8" (92)
		7	1-13/32" (36)	1-1/4" (32)	2-15/16" (75)	3-13/16" (97)
5109	Security cylinder	6	1-7/32" (31)	1-3/32" (28)	2-3/4" (70)	3-5/8" (92)
		7	1-13/32" (36)	1-1/4" (32)	2-15/16" (75)	3-13/16" (97)
2109 [^]	Schlage® "C" keyway cylinder - 0-bitted or keyed random	6	1-7/32" (31)	1-3/32" (28)	2-3/4" (70)	3-5/8" (92)

[^]Available in 606, 612, 613 and 626 finishes only.

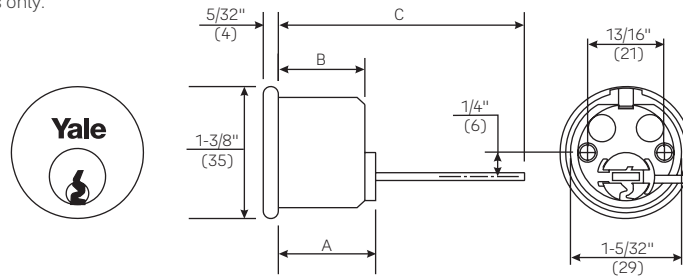

Fixed Core For Hotel/Motel Function Products

Model #	Description	No. of Active Pins	Dim A	Dim B	Dim C Tailpiece Model Numbers	
					#1145	#1147
1179*	Standard cylinder for Hotel/Motel function	6	1-5/8" (41)	1-3/32" (28)	3-3/16" (81)	4" (102)

*Cylinders are 6-pin for master keying expansion purposes. Locksets and housings will be 7-pin in length to accommodate top level master keys. See page 6 for more information.

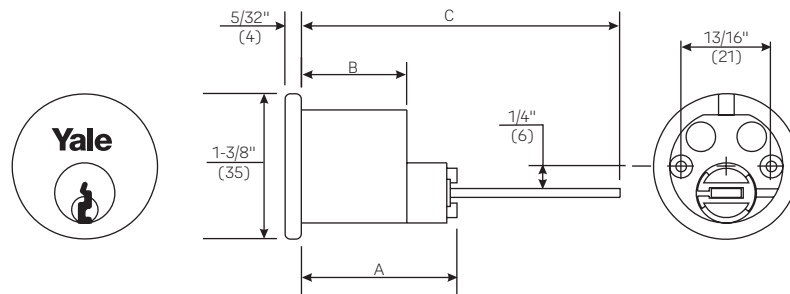

Dimensions are shown in inches (millimeters)

Rim Cylinders



With Lazy Cam Operation

Model #	Description	No. of Active Pins	Dim A	Dim B	Dim C Tailpiece Model Numbers
1709	Standard cylinder with lazy cam operation	5 or 6	1-11/32" (34)	31/32" (25)	3-3/16" (81)
		7	1-1/2" (38)	1-1/8" (29)	3-7/32" (82)

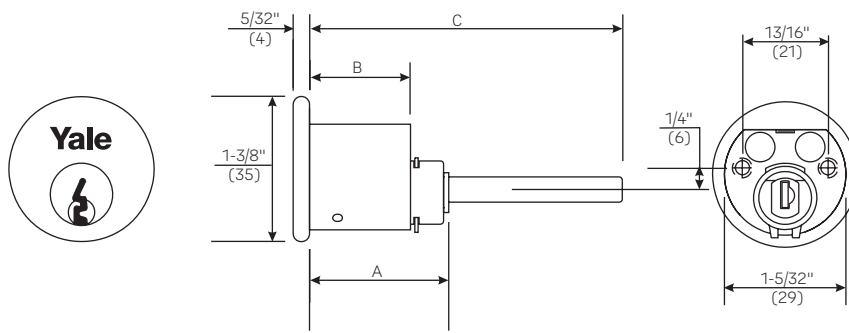

Fixed Core High Security

Model #	Description	No. of Active Pins	Dim A	Dim B	Dim C Tailpiece Lengths	
					#1145	#1147
U5109	High Security Cylinder	6	1-1/16" (27)	15/16" (24)	2-7/16" (62)	3-5/8" (84)
		7	1-1/8" (29)	1-1/16" (27)	2-5/8" (67)	3-1/16" (89)

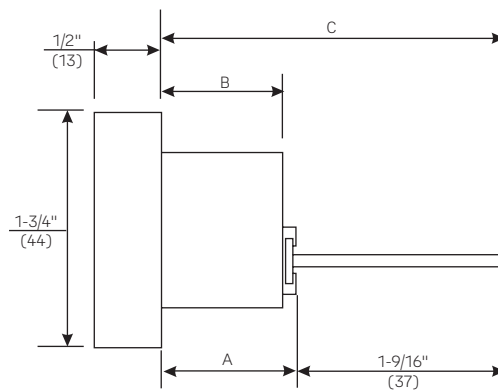

Dimensions are shown in inches (millimeters)

Rim Cylinders



Large Format Interchangeable Core (LFIC) For Current Products

Includes standard, hotel, security and high security large format interchangeable core for rim lock and exit device trim applications. When ordering interchangeable core cylinders or cores only, control keys are not furnished. If control keys are required, they must be specified.



Model Numbers			Description	No. of Active Pins	Dim A	Dim B	Dim C Tailpiece Model Numbers	
Complete Cylinder	Core Only	Housing Only					#1145	#1147
1193	1210	1212	Standard cylinder	6	1-7/16" (37)	1-3/8" (27)	2-15/16" (75)	3-3/4" (95)
1193	1220	1212B	Standard cylinder	7	1-5/8" (41)	1-9/16" (40)	3-1/8" (79)	4-5/16" (110)
5193	5210	1212	Security cylinder	6	1-7/16" (37)	1-3/8" (35)	2-15/16" (75)	3-3/4" (95)
5193	5220	1212B	Security cylinder	7	1-5/8" (41)	1-9/16" (40)	3-1/8" (79)	4-5/16" (110)

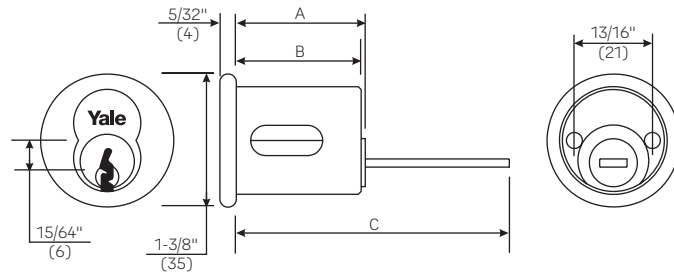

Large Format Interchangeable Core (LFIC) With Lazy Cam Operation

Model Numbers			Description	No. of Active Pins	Dim A	Dim B	Dim C
Complete Cylinder	Core Only	Housing Assembly					
1193L	1210	*	Standard cylinder with lazy cam operation	6	1-3/4" (44)	1-3/8" (35)	3-1/2" (89)

*Uses 1212 housing with lazy cam. Specify by part number 10-1193-0044 x Finish

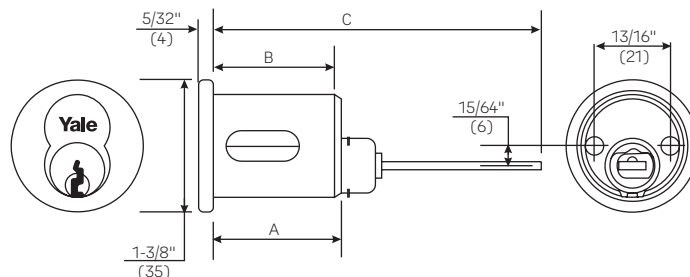

Dimensions are shown in inches (millimeters)

Component Cylinders



Includes standard and security for cylindrical lock, exit trim and deadbolt applications.

Knob Cylinders

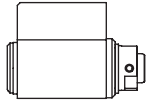

Lever Cylinders

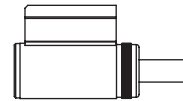
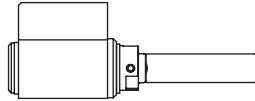

Conventional

Model #	No. of Pins	Tailpiece Part Number (Length)*	Applications
Cylindrical Locks & Exit Device Trim			
1801	6	None	Standard for 5300 [^] & 5400 [^] series knob locks and 540F series trim.
1801A	7	None	Standard for 5400 [^] series knob locks and 540F series trim.
1802	6	14-5407-1039-048 (1.69")	Standard for 5400LN, 6400LN & inTouch [^] lever locks and 440F, 540F & 580F series trims. Optional for 4700LN & 5300LN series lever locks. Sleeve 14-5305-9078-999 required for use with 4700LN, 5300LN, inTouch and 440F trims.
1802A	7	14-5407-1049-048 (1.50")	Standard for 5400LN & 6400LN series lever locks and 540F & 580F series trims.
1802L	6	14-5305-1060-048 (2.00")	Optional for 5300LN series locks used with 2" to 2-1/4" thick doors. Sleeve 14-5305-9078-999 required.
1802S	6	14-5417-1024-048 (.940")	Standard for 5417LN & 6417LN function inside lever locks
1803-54L	6	17-1803-1005 (.692")	Standard for Corbin Russwin CL3100 (YC) & Sargent 11 Line (YC-) series lever locks. Optional for 4300LN, 4600LN & 4800LN [^] series lever locks.
1803A-54L	7	17-1803-1004 (.536")	Standard for Corbin Russwin CL3100 (YC7), Sargent 11 Line (YC-7P-) series lever locks.
1803-54K	6	17-1803-1005 (.692")	Standard for 5400CK series knob locks and YH Collection lever locks.
1803-53L	6	17-1803-1011 (1.700")	Standard for nexTouch™ cylindrical lever locks. Optional for inTouch [^] lever locks. Sleeve 14-1803-9001-999 required.
1803-47L	6	17-1803-1012 (1.930")	Standard for 4700LN & 5300LN series lever locks. Optional for 440F series trim. Sleeve 14-1803-9001-999 required.
1803-46L	6	17-1803-1006 (1.106")	Standard for Corbin Russwin CLX3300 (YC) & SARGENT 10X Line (YC-) series cylindrical locks, 1-3/8" – 2" doors.
1803-46LL	6	17-1803-1008 (1.330")	Standard for Corbin Russwin CLX3300 (YC) & SARGENT 10X Line (YC-) series cylindrical locks, 2-1/4" doors.
1803A-46L	7	17-1803-1007 (.950")	Standard for Corbin Russwin CLX3300 (YC7) & SARGENT 10X Line (YC-7P-) series cylindrical locks, 1-3/8" – 2" doors.
1803A-46LL	7	17-1803-1009 (1.174")	Standard for Corbin Russwin CLX3300 (YC7) & SARGENT 10X Line (YC-7P-) series cylindrical locks, 2-1/4" doors.
1803-46K	6	17-1803-1006 (1.106")	Optional for 4600 series knob locks.
1805	6	S13-0919-999 (1.161")	Standard for 4600 & 4700 [^] series knob locks.
1806	6	S05-0215-999 (.844")	Standard for 4600LN series lever locks.
1812	6	14-4307-1000-048 (.614")	Standard for 4300 [^] , 4300LN & 4800LN [^] series knob/lever locks.
Deadbolts			
1803-134S	6	17-1803-1013 (2.30")	Standard for YH Collection deadbolt used with interconnected lock (non-face removable). Optional for D Series deadbolts, single cylinder functions.
1803-134D	6	17-1803-1014 (.87")	Optional for D Series deadbolts, double cylinder functions.
1807	6	S13-0880 (2.134")	Standard for D series deadbolts, single cylinder functions.
1808	6	S13-0878 (.812")	Standard for D series deadbolts, double cylinder functions.
1814	6	14-3721-1007 (1.94")	Standard for 4800LN [^] series deadbolt.

*Tailpiece length specified for 1-3/4" door. For other door thicknesses, contact technical support.

[^] Lockset series obsolete.

Component Cylinders



Security

Model #	No. of Pins	Tailpiece Part Number (Length)*	Applications
Cylindrical Locks & Exit Device Trim			
5801C	6	None	Optional for 5300^ & 5400^ series knob locks and 540F series trim.
5801A	7	None	Optional for 5400^ series knob locks and 540F series trim.
5802	6	14-5407-1039-048 (1.69")	Optional for 4700LN, 5300LN, 5400LN, 6400LN & inTouch® lever locks and 440F, 540F & 580F series trims. Sleeve 14-5305-9078-999 required for use with 4700LN, 5300LN, inTouch and 440F trims.
5802A	7	14-5407-1049-048 (1.50")	Optional for 5400LN & 6400LN series lever locks and 540F & 580F series trims.
5812	6	14-4307-1000-048 (.614")	Optional for 4300^, 4300LN & 4800LN^ series knob/lever locks.
5803-54L	6	17-1803-1005 (.692")	Optional for Corbin Russwin CL3100 (YC) & Sargent 11 Line (YC-) series lever locks. Optional for 4300LN, 4600LN & 4800LN^ series lever locks.
5803A-54L	7	17-1803-1004 (.536")	Optional for Corbin Russwin CL3100 (YC7), Sargent 11 Line (YC-7P-) series lever locks.
5803-54K	6	17-1803-1005 (.692")	Optional for 5400CK series knob locks and YH Collection lever locks.
5803-53L	6	17-1803-1011 (1.700")	Optional for nexTouch™ cylindrical and inTouch® lever locks. Sleeve 14-1803-9001-999 required.
5803-47L	6	17-1803-1012 (1.930")	Standard for 4700LN & 5300LN series lever locks. Optional for 440F series trim. Sleeve 14-1803-9001-999 required.
5803-46L	6	17-1803-1006 (1.106")	Standard for Corbin Russwin CLX3300 (YC) & SARGENT 10X Line (YC-) series cylindrical locks, 1-3/8" – 2" doors.
5803-46LL	6	17-1803-1008 (1.330")	Standard for Corbin Russwin CLX3300 (YC) & SARGENT 10X Line (YC-) series cylindrical locks, 2-1/4" doors.
5803A-46L	7	17-1803-1007 (.950")	Standard for Corbin Russwin CLX3300 (YC7) & SARGENT 10X Line (YC-7P-) series cylindrical locks, 1-3/8" – 2" doors.
5803A-46LL	7	17-1803-1009 (1.174")	Standard for Corbin Russwin CLX3300 (YC7) & SARGENT 10X Line (YC-7P-) series cylindrical locks, 2-1/4" doors.
5803-46K	6	17-1803-1006 (1.106")	Optional for 4600 series knob locks.
Deadbolts			
5814	6	14-3721-1007 (1.94")	Optional for 4800LN^ series deadbolt.
5803-134S	6	17-1803-1013 (2.30")	Optional for YH Collection deadbolt used with interconnected lock (non-face removable). Optional for D Series deadbolts, single cylinder functions.
5803-134D	6	17-1803-1014 (.87")	Optional for D Series deadbolts, double cylinder functions.

*Tailpiece length specified for 1-3/4" door. For other door thicknesses, contact technical support.

^ Lockset series obsolete.

Component Cylinders



Other Manufacturer's Keyway

Model #	No. of Pins	Tailpiece Part Number (Length)*	Applications
Cylindrical Locks & Exit Device Trim			
2801	6	None	Schlage® "C" keyway for 5300^ & 5400^ series locks and 540F series trim.
2802	6	14-5407-1039-048 (1.69")	Schlage® "C" keyway for 5300LN, 5400LN, 6400LN & inTouch®^ series lever locks and 440F, 540F & 580F series trims. Sleeve 14-5305-9078-999 required for use with 4700LN, 5300LN, inTouch and 440F trims.
2805	6	S13-0919-999 (1.161")	Schlage® "C" keyway for 4600 & 4700^ series knob locks.
2806	6	S05-0215-999 (.844")	Schlage® "C" keyway for 4600LN series lever locks.
2812	6	14-4307-1000-048 (.614")	Schlage® "C" keyway for 4300^, 4300LN & 4800LN^ series knob/lever locks.
2803-54L	6	17-1803-1005 (.692")	Optional for Corbin Russwin CL3100 (YC) & Sargent 11 Line (YC-) series lever locks. Optional for 4300LN, 4600LN & 4800LN^ series lever locks.
2803-54K	6	17-1803-1005 (.692")	Schlage® "C" keyway for 5400CK series knob locks and YH Collection lever locks.
2803-53L	6	17-1803-1011 (1.700")	Schlage® "C" keyway for nexTouch™ cylindrical lever locks. Optional for inTouch®^ lever locks. Sleeve 14-1803-9001-999 required.
2803-47L	6	17-1803-1012 (1.930")	Standard for 4700LN & 5300LN series lever locks. Optional for 440F series trim. Sleeve 14-1803-9001-999 required.
2803-46L	6	17-1803-1006 (1.106")	Optional for Corbin Russwin CLX3300 (YC) & SARGENT 10X Line (YC-) series cylindrical locks, 1-3/8" – 2" doors.
2803-46K	6	17-1803-1006 (1.106")	Optional for 4600 series knob locks.
3804	6	14-5407-0460-048 (1.70")	Other manufacturer's keyway for 4700LN, 5300LN, 5400LN, 6400LN & inTouch®^ lever locks and 440F, 540F & 580F series trims.
3805	6	Contact technical support	Other manufacturer's keyway for 4700^ series knob locks.
3806	6	Tailpieces from pack included with cylinder (.925" for lever lock & .690" for knob lock)	Other manufacturer's keyway for 4600 & 4600LN series knob/lever locks.
3803-54L	6	17-1803-1005 (.692")	Optional for Corbin Russwin CL3100 (YC) & Sargent 11 Line (YC-) series lever locks. Optional for 4300LN, 4600LN & 4800LN^ series lever locks.
3803-54K	6	17-1803-1005 (.692")	Other manufacturer's keyway for 5400CK series knob locks and YH Collection lever locks.
3803-53L	6	17-1803-1011 (1.700")	Other manufacturer's keyway for nexTouch™ cylindrical lever locks. Optional for inTouch®^ lever locks. Sleeve 14-1803-9001-999 required.
3803-47L	6	17-1803-1012 (1.930")	Standard for 4700LN & 5300LN series lever locks. Optional for 440F series trim. Sleeve 14-1803-9001-999 required.
3803-46L	6	17-1803-1006 (1.106")	Optional for Corbin Russwin CLX3300 (YC) & SARGENT 10X Line (YC-) series cylindrical locks, 1-3/8" – 2" doors.
3803-46K	6	17-1803-1006 (1.106")	Optional for 4600 series knob locks.
100CV1	6	Contact technical support	Arrow AR keyway for nexTouch™ cylindrical lever locks.

*Tailpiece length specified for 1-3/4" door. For other door thicknesses, contact technical support.

^ Lockset series obsolete.

Notes:

- Schlage® C keyway cylinders (28XX) are available keyed random or 0-bitted.
- Other manufacturer's keyway cylinders (38XX) are only available keyed random, please specify keyway. Available keyways are Sargent LA, Schlage® E, Corbin Russwin L4, Corbin® 60 and Russwin® D1.

Component Cylinders



Other Manufacturer's Keyway (Cont.)

Model #	No. of Pins	Tailpiece Part Number (Length)*	Applications
Deadbolts			
2807	6	S13-0880 (2.134")	Schlage® "C" keyway for D series deadbolts, single cylinder functions
2808	6	S13-0878 (.812")	Schlage® "C" keyway for D series deadbolts, double cylinder functions
2814	6	14-3721-1007 (1.94")	Schlage® "C" keyway for 4800LN^ series deadbolt
2803-134S	6	17-1803-1013 (2.30")	Schlage® "C" keyway for YH Collection deadbolt used with interconnected lock (non-face removable). Optional for D Series deadbolts, single cylinder functions.
2803-134D	6	17-1803-1014 (.87")	Schlage® "C" keyway for D Series deadbolts, double cylinder functions
3806	6	Tailpieces from the pack included with cylinder (2.130" for single cylinder function & .950" for double cylinder function)	Other manufacturer's keyway for D series deadbolts
3803-134S	6	17-1803-1013 (2.30")	Other manufacturer's keyway for YH Collection Deadbolt used with interconnected lock (non-face removable). Optional for D Series deadbolts, single cylinder functions.
3803-134D	6	17-1803-1014 (.87")	Other manufacturer's keyway for D Series deadbolts, double cylinder functions

*Tailpiece length specified for 1-3/4" door. For other door thicknesses, contact technical support.

^Lockset series obsolete.

Notes:

- Schlage® C keyway cylinders (28XX) are available keyed random or 0-bitted.
- Other manufacturer's keyway cylinders (38XX) are only available keyed random, please specify keyway. Available keyways are Sargent LA, Schlage® E, Corbin Russwin L4, Corbin® 60 and Russwin® D1.

Interchangeable Core



Large Format

Large format cores are interchangeable with Yale® mortise locks, cylindrical locks and exit device trims and can be keyed in conjunction with standard cylinders. When ordering cores only, control keys are not furnished. If control keys are required, they must be specified.



Model #	Description	Number of Active Pins
1210	Standard large format core	6
1220	Standard large format core	7
1210H*	Standard large format core for Hotel/Motel functions 8820, 8827, and 8832	6
5210	Security large format core	6
5220	Security large format core	7
5210H*	Security large format core for Hotel/Motel functions 8820, 8827, and 8832	6

*Cores are 6-pin for master keying expansion purposes, but locksets and housing must be 7-pin in length to accommodate top level master keys. See page 6 for more information.

Small Format

Yale offers SFIC cores in Yale® KeyMark® (see separate catalog for more information) or Best® keyways A, B, C, D, E, F, G, H, J, K, L and M.



Best® keyway cores can be provided random keyed, master keyed or uncombined. Yale will provide master keying to a new key system only. Systems can be provided using the A2 or A4 pinning specification and can not be tied into any conventional or Yale KeyMark key systems.

All cylindrical lock small format preparations accept either 6- or 7-pin cores. For mortise and rim housings, see chart below. When ordering cores only, control keys are not furnished. If control keys are required, they must be specified.

Model Numbers			Description	Lengths		Cam/Tailpiece
Complete Cylinder	Core Only	Housing Only		6-Pin	7-Pin	
A620	A600	K660	Best® keyway mortise cylinder	1-1/4" (32) 1-3/8" (35)	1-3/8" (35) 1-3/4" (44)	KC1*
A630	A600	K670	Best® keyway tapered mortise cylinder	1-1/4" (32) 1-3/8" (35)	1-3/8" (35)	KC1
A640	A600	K680	Best® keyway rim cylinder	1-1/4" (32) 1-3/8" (35)	1-3/8" (35)	KT1
—	K925	—	Disposable thumbturn only, used with 6- or 7-pin	—	—	—
—	K926	—	Temporary construction core only, used with 6-or 7-pin	—	—	—

*Refer to the Yale® KeyMark® catalog page 14 for optional cams and page 18 for more information on SFIC construction core program. For 1-3/4" housing, the cam is riveted; therefore only KC1 is available. For 6-pin, 1-1/4" will be supplied unless otherwise specified.



Key Blanks

Yale offers .51" pin tumbler key blanks in several lengths and bow styles. All key blanks are supplied in nickel silver and are available in all .51" key sections. See page 21 for key sections.

Keys are available with special stamping, i.e. Do Not Duplicate. Custom die stamps are also available upon request. Contact customer service for more information.

How To Order

Bow Style	Key Blank Material	Basic Model Number	Key Section
R	N	11	GA
See Below	Nickel Silver	.51" Pin Tumbler 9 = 4 Pin 8 = 5 Pin 11 = 6 Pin 117 = 7 Pin 118 = 8 Pin 411 = 7-1/2 Pin 411S = 6 Pin	See page 21

Bow Styles



R

Standard bow furnished for all conventional keys.

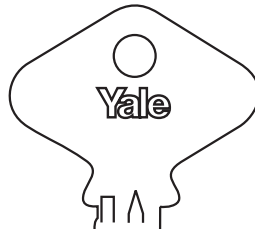

F

Standard bow furnished for control keys, optional for conventional keys.



A

Standard bow furnished for security and high security keys, optional for conventional keys.

.51" Pin Tumbler Key Blanks

Model Number	Length
RN9.....	4-pin
RN8.....	5-pin
RN11.....	6-pin
RN117.....	7-pin

Model Number	Length
FN8.....	5-pin
FN11.....	6-pin
FN117.....	7-pin
FN118.....	8-pin

Model Number	Length
*AN8.....	5-pin
*AN11.....	6-pin
AN117.....	7-pin

*Standard keybow for high security key blanks, letter of authorization required. Side cuts are factory machined.

Key Blanks



LFIC Control Key Blanks

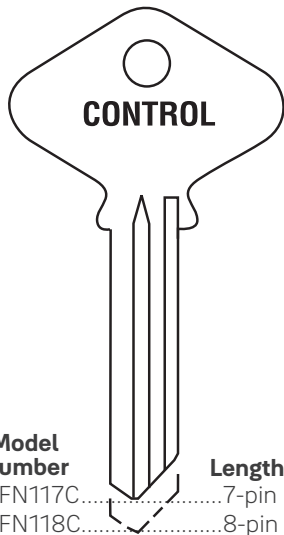

Hotel/Motel Key Blanks

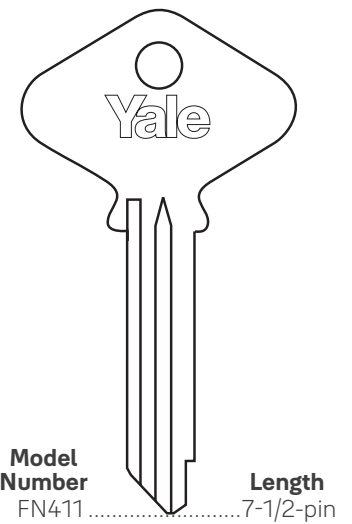
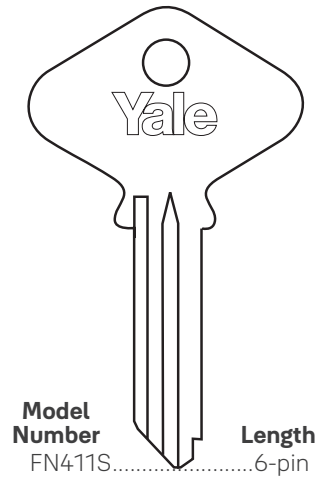

Furnished all 'O' cuts except for #1 cut on tip of key. Stamped with 'Control'. "F" bow shown also available "R" bow.

SFIC Key Blanks

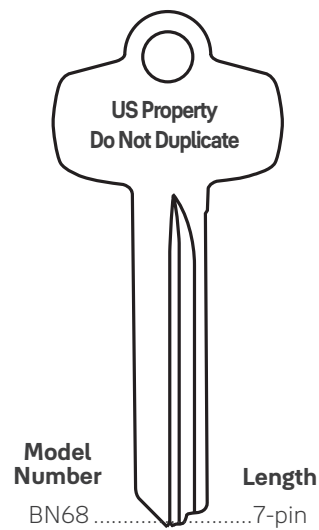
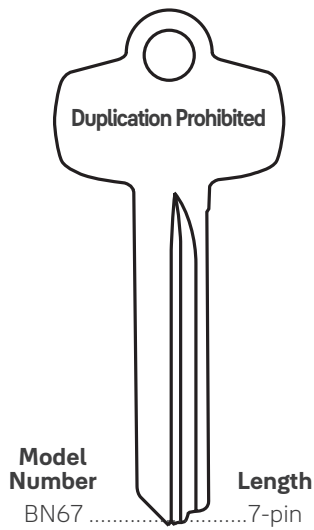

Note: SFIC keys are cut from tip to bow. The same key blank can be used for both 6- and 7-pin keys. Only available with Best® keyways A, B, C, D, E, F, G, H, J, K, L and M

Keyways

Simplex/Multiplex Keyways

A simplex keyway is independent, stands alone and cannot be tied into any other keyway to expand a keying system. Multiplex keyways can be used together to expand a keying system.

Active Keyways

Keyways which are available for new Yale® keying systems are considered active. In the case of new master key systems, the factory reserves the right to select the keyway from a range of standard keyways, based on usage in a particular geographical area. Common active keyways shown below.

All/Multi-Section/Single Section Keys

All multi-section keys can be used on more than one cylinder with different sections. For example: a key cut on the GV multi-section key blank will pass cylinder in the GA, GB, GG and GH keyways. Single section keys can only be used with cylinders of the same section. For example: a key cut on the GA single section key blank will only pass a cylinder in the GA keyway.

Inactive Keyways

Many older Yale keyways are inactive. New key systems will not be established on these. However, they continue to be available to support existing keying systems.

Simplex

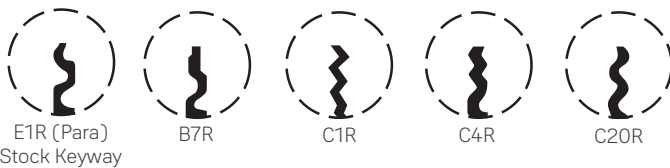

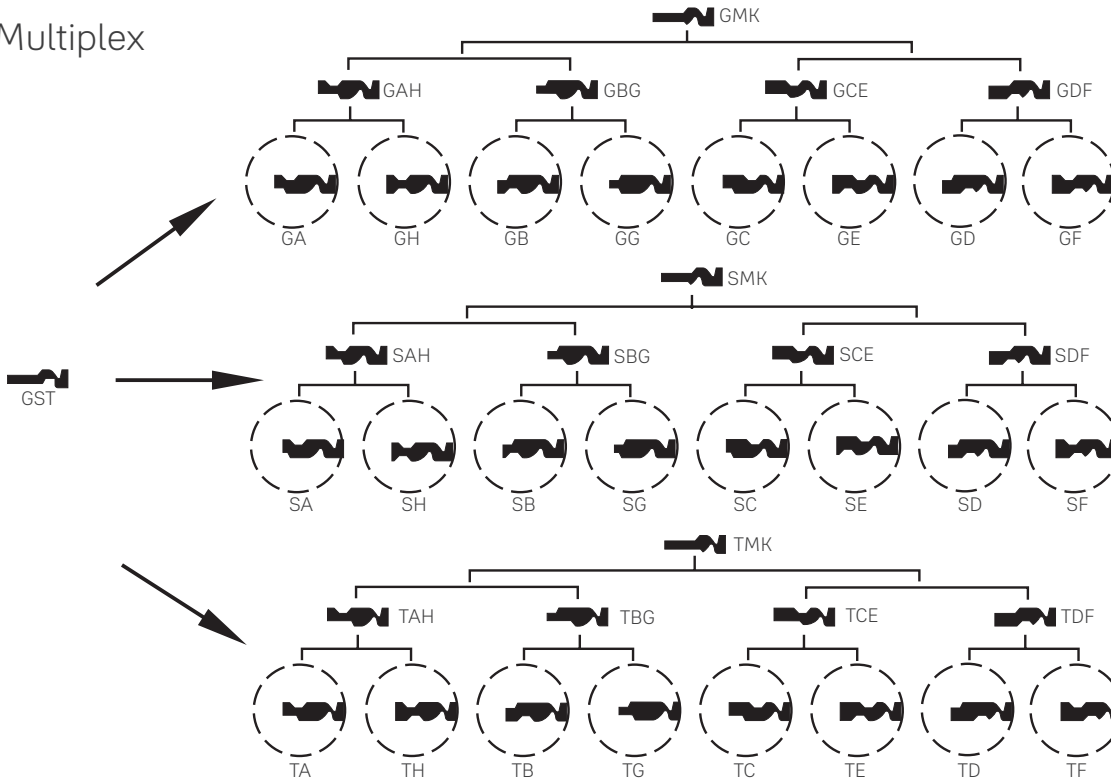

Multiplex



Notes: The section of the key is determined by viewing the key from the bow towards the tip.
For security reasons, restricted and protected keyway profiles are not shown.

Cams

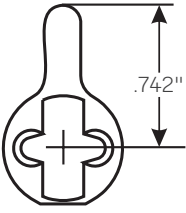
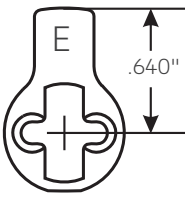
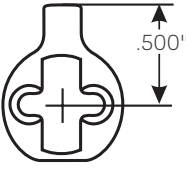
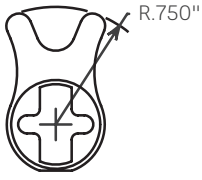
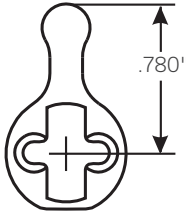
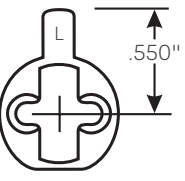
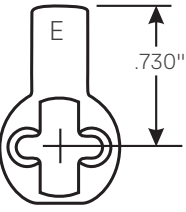
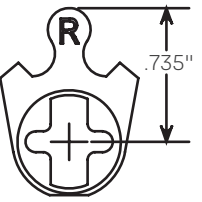
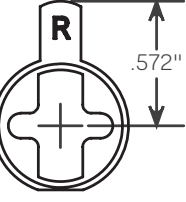
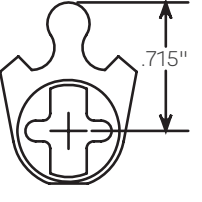
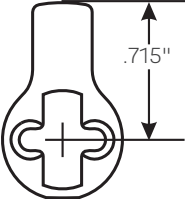

Model No.	Description	Application	Model No.	Description	Application		
	2160	Std for 2123, 2153, S2053, 2719, 5153, U5153, 5719, 2196, 2197, 2196H, 5196, 5197, 5196H	Steel case mortise or auxiliary locks, exit device alarms and cylinder dogging for 7000 series exit devices.		1161E	Opt for 1194, Std for 2153 when used for 2100 cylinder dogging	Obsolete cast iron mortise locks, cylinder dogging for 2100 series exit devices.
	2130	Std for 2123S, 2153S, S2053S, 2196S, 2197S, 5196S, 5197S	Steel case mortise locks, inside operation for 8817-2 and 8834-2 functions.		1161G	Opt for 1194, 1194H, 5194, 5194H	Keyswitches.
	1160	Std for 1153, S1053H, 1719, 5719, U5719	Obsolete 310 series deadlocks.		1161L	Opt for 1123, 1152, S1052H, 5152, U5152	Adams Rite MS 1800 series locks and 4700 series latches.
	1160E	Std for 1194, 1194H, 5194, 5194H	Obsolete cast iron mortise locks.		1161U	Opt for 1194, 1194H, 5194, 5194H	Corbin Russwin interchangeable core (A01)
	1160L	Opt for 1194, 1194H, 5194, 5194H	Adams Rite MS 1800 series locks and 4700 series latches.		1161T	Opt for 1123, 1152, 1186, S1052H, 5152, U5152	Corbin Russwin fixed core (A01)
	1161	Std for 1123, 1152, S1052H, 5152, U5152	Obsolete cast iron mortise locks.		10-6120-9010	Cam Disc	Filler for hollow mill cams.

All cams and cam disc illustrated actual size.



Collars

Cylinder collars are supplied as standard where required with products supplied with cylinders. Collar size and thickness are supplied to suit the length of the cylinder, the thickness of the door and the trim ordered. (If door thickness is not specified, collars will be supplied to suit 1-3/4" (44mm) door.)

Collar length required must be specified for cylinders and/or housings ordered separately. Refer to individual product sections for collar applications and sizes.

1765 Recessed Cylinder Collar

"A" Dimension: See chart for available sizes. To order, specify "1765.size" i.e. 1765.250.

Material: Brass, Stainless Steel

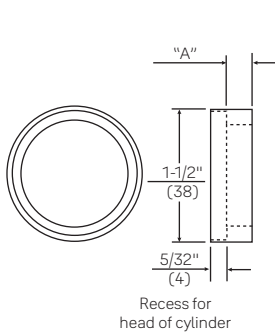

"A" Dimension	
Size	Specify
1/16"	.062
3/32"	.094
1/8"	.125
5/32"	.156
3/16"	.187
7/32"	.219
1/4"	.250
9/32"	.281
5/16"	.312

"A" Dimension	
Size	Specify
11/32"	.344
3/8"	.375
13/32"	.406
7/16"	.437
15/32"	.469
1/2"	.500
17/32"	.531
9/16"	.563
19/32"	.594

"A" Dimension	
Size	Specify
21/32"	.656
23/32"	.719
3/4"	.750
27/32"	.844
59/64"	.924
15/16"	.937
1-15/32"	1.473

1766 Step Collar for U5109 and U5153 High Security Cylinders.

Material: Stainless Steel

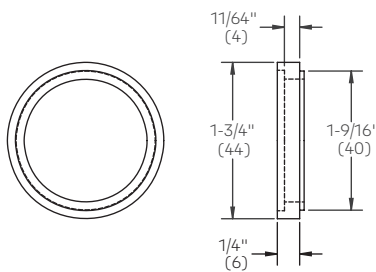

KP4 Flush Mount Cylinder Collar

Material: Brass, Bronze

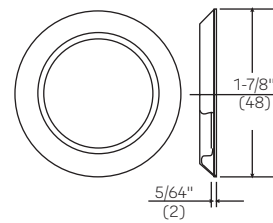

599 Recessed Cylinder Collar

"A" Dimension: See chart for available sizes. To order, specify "599.size" i.e. 599.419.

Material: Brass

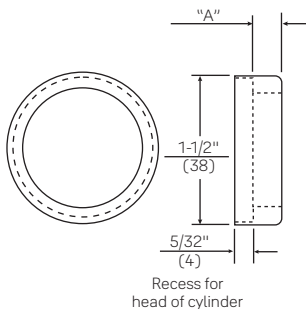

"A" Dimension	
Size	Specify
27/64"	.419
35/64"	.544
45/64"	.700
55/64"	.850
59/64"	.925
1-3/64"	1.040



Pins And Pin Kits

Yale® pinning kits contain the components required to key Yale conventional cylinders, both fixed and large format interchangeable core. (.51" plug diameter).

All components are packed in a sturdy metal case.

Features

- Pin tray lifts out to provide storage space.
- Pin chart on inside lid for convenient reference.

Pins and springs are packed by size, in bags of 100. Each kit contains bottom pins, master pins, top pins and springs. Both kits include tweezers and a plug follower.

SK-12 Pin Kit - .019" Step				
Model No.	Qty.	Description	Size	Pin Length
SK-12	1	Pin Kit - Complete	.019 Step	---
R19	1	Refill Kit - Complete	.019 Step	---
020	1	Plug Follower	---	---
021	1	Tweezers	---	---
251-0	100	Bottom Pin	0	.182
251-1	100	Bottom Pin	1	.201
251-2	100	Bottom Pin	2	.220
251-3	100	Bottom Pin	3	.239
251-4	100	Bottom Pin	4	.258
251-5	100	Bottom Pin	5	.277
251-6	100	Bottom Pin	6	.296
251-7	100	Bottom Pin	7	.315
251-8	100	Bottom Pin	8	.334
251-9	100	Bottom Pin	9	.353
351-2	100	Top Pin (Driver)	2	.152
351-3	100	Top Pin (Driver)	3	.190
351-4	100	Top Pin (Driver)	4	.230
451-2	100	Master Pin	2	.038
451-4	100	Master Pin	4	.076
451-6	100	Master Pin	6	.114
451-8	100	Master Pin	8	.152
151	100	Spring	---	---

SK-13 Pin Kit - .025" Step				
Model No.	Qty.	Description	Size	Pin Length
SK-13	1	Pin Kit - Complete	.025 Step	---
R25	1	Refill Kit - Complete	.025 Step	---
020	1	Plug Follower	---	---
021	1	Tweezers	---	---
251A-0	100	Bottom Pin	0	.182
251A-1	100	Bottom Pin	1	.207
251A-2	100	Bottom Pin	2	.232
251A-3	100	Bottom Pin	3	.258
251A-4	100	Bottom Pin	4	.282
251A-5	100	Bottom Pin	5	.307
251A-6	100	Bottom Pin	6	.334
251A-7	100	Bottom Pin	7	.357
351-2	100	Top Pin (Driver)	2	.152
351-3	100	Top Pin (Driver)	3	.190
351-4	100	Top Pin (Driver)	4	.230
451A-2	100	Master Pin	2	.050
451A-3	100	Master Pin	3	.076
451A-4	100	Master Pin	4	.10.0
451A-5	100	Master Pin	5	.125
451A-6	100	Master Pin	6	.152
451A-7	100	Master Pin	7	.175
151	100	Spring	---	---



Pinning Tools

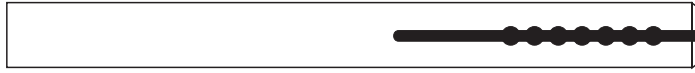

Set up plug
No. M36 For .51" plug
No. M38 For .40" plug

No. M43 Shove Knife

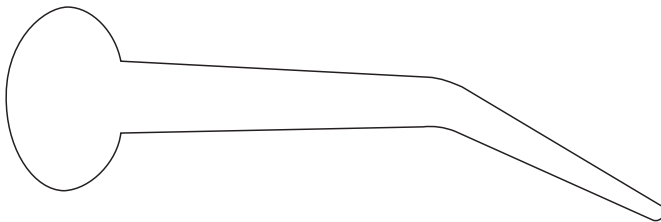

No. 020 Plug Follower
For .51" plug

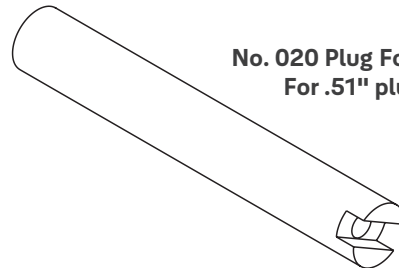

No. 021 Tweezers

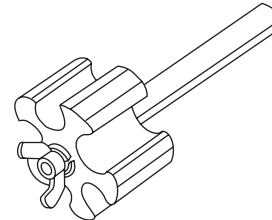
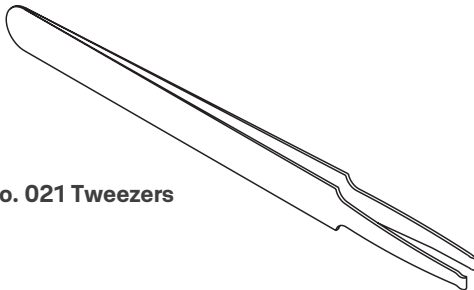

No. M33 Vice Held Plug Holder

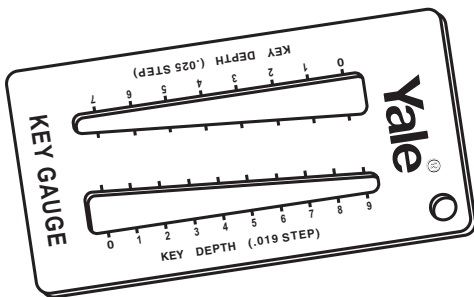

No. KG1 Key Gauge (.019" and .025" increment)

Holds the 5 most popular plug diameters:

- .404" (10.26mm)
- .504" (12.80mm)
- .508" (12.90mm)
- .512" (13.00mm)
- .556" (14.12mm)



Mortise

Plugs	
Part Number	Description
96-0000-2004	Fixed Core 6-pin, 1-1/8"
96-0000-2005	Fixed Core 6-pin, 1-1/4"
96-0000-2006	Fixed Core 7-pin, 1-1/4"
96-0000-2009	Fixed Core 7-pin, 1-1/2"
96-0000-2013	Fixed Core 6-pin, 1-3/4"
96-0000-2014	Fixed Core 7-pin, 1-3/4"
96-0000-2705	LFIC 6-pin
96-0000-2706	LFIC 7-pin

Specify Keyway and Finish

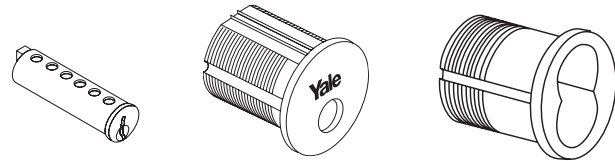

Shells	
Part Number	Description
10-1152-2031	Fixed Core 6-pin, 1-1/8"
10-1152-2064	Fixed Core 6- or 7-pin, 1-1/4"
10-1152-2023	Fixed Core 7-pin, 1-1/2"
10-1152-2033	Fixed Core 6- or 7-pin, 1-3/4"

Specify Finish

Housings (Less Cam)	
Part Number	Description
10-1194-2033	LFIC 6-pin, 1-1/2"
10-1194-2035	LFIC 6-pin, 1-3/4"
10-1194-0004	LFIC 7-pin, 1-11/16"
10-1194-2036	LFIC 6- or 7-pin, 2"

Specify Finish

Other	
Part Number	Description
10-1194-2041-000	Cam hub for 6-pin, 1-1/2" housing
10-1194-2043-000	Cam hub for 6-pin, 1-3/4" housing
10-1194-2041-000	Cam hub for 7-pin, 1-11/16" housing
10-1194-2044-000	Cam hub for 6- or 7-pin, 2" housing
99-9999-4525-999	Plug retainer for 1210 and 1220 core
81-0611-0154-036	Cam screws for 2153, 2196 and 2197

Component

Plugs	
Part Number	Description
96-0000-2154	Fixed Core 6-pin for 1801 or 1802
96-0000-2156	Fixed Core 7-pin for 1801 or 1802
96-0000-2234	Fixed Core 6-pin for 1803

Specify Keyway and Finish

Shells	
Part Number	Description
14-1801-2021-000	Fixed Core 6-pin for 1801 or 1802
14-1802-2050-000	Fixed Core 7-pin for 1801 or 1802
14-1803-2001-000	Fixed Core 6-pin for 1803

Other	
Part Number	Description
99-9999-4561-999	Plug retainer for 1801 or 1802
99-9999-4001-000	Roll pin for 1802
14-5407-1039-048	Tailpiece for 1802
17-1803-7001	Cap pin spring for 1803
17-1803-2002	Cap pin for 1803
17-1803-2003	Cylinder cap for 1803
17-1194-2302	Spring cover 6-pin for 1803

See pages 14-17 for additional tailpiece part numbers.



Parts

Rim

Plugs	
Part Number	Description
96-0000-2225	Fixed Core 5-pin for 1109
96-0000-2226	Fixed Core 6-pin for 1109
96-0000-2227	Fixed Core 7-pin for 1109
96-0000-2705	LFIC 6-pin
96-0000-2706	LFIC 7-pin
96-0000-2330	Fixed Core 5- or 6-pin for 1709
96-0000-2331	Fixed Core 7-pin for 1709

Specify Keyway and Finish

Housings	
Part Number	Description
10-1193-0041	LFIC 6-pin
10-1193-0042	LFIC 7-pin

Specify Finish

Shells	
Part Number	Description
34-1109-2027	Fixed Core 5-pin for 1109
34-1109-2028	Fixed Core 6-pin for 1109
34-1109-2029	Fixed Core 7-pin for 1109
10-1709-2096	Fixed Core 5- or 6-pin for 1709
10-1709-2099	Fixed Core 7-pin for 1709

Specify Finish

Other	
Part Number	Description
34-1145-1002-059	1145 Tailpiece
34-1147-1003-059	1147 Tailpiece
34-1145-1005-059	Von Duprin Tailpiece
34-0010-1015-059	Backplate
34-2311-8738-048	Mounting screws for 1109
10-1193-1018-049	Mounting screws for 1193
34-1451-1003-000	Plug retainer for 1109
99-9999-4561-999	Plug retainer for 1709
14-3511-6102-082	Lazy cam for 1709
14-3511-1014-048	D-Ring for 1709
10-1451-1010-048	Tailpiece for 1709
14-3511-1013-048	Lazy cam collar for 1709

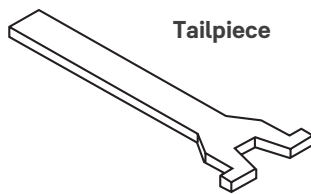

Tailpiece

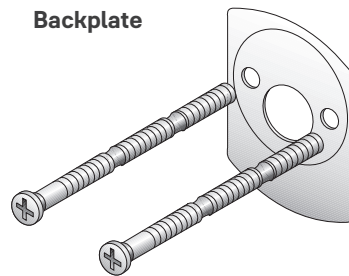

Backplate



Retainer

Dust Shields

Cylinders are available with a dust shield to protect the pin tumblers and plug from the penetration of dust, sand and other contaminants. To order, prefix the cylinder model number with the letter "D", i.e. D2153. Dust shields are not available with any cylinder using "A" bow keys.

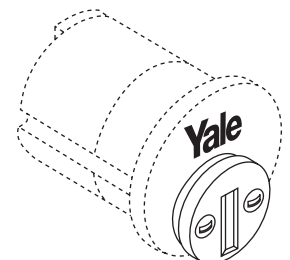

.019" Specification

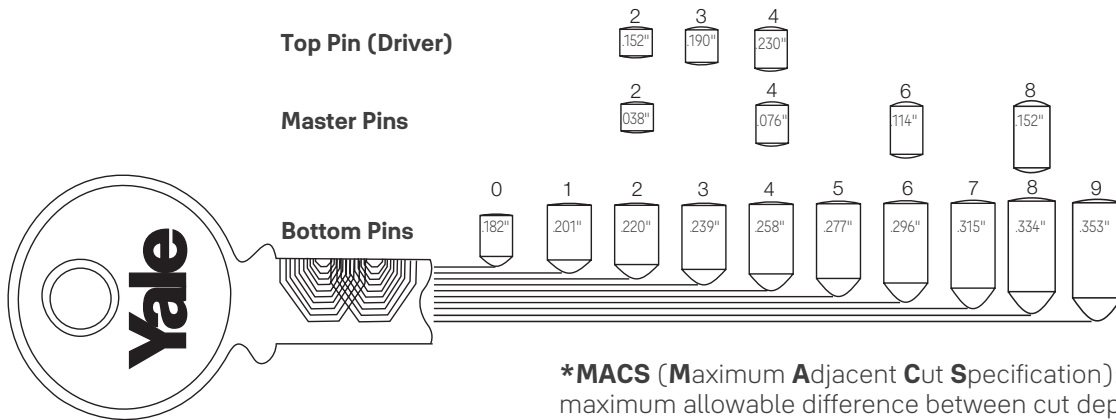
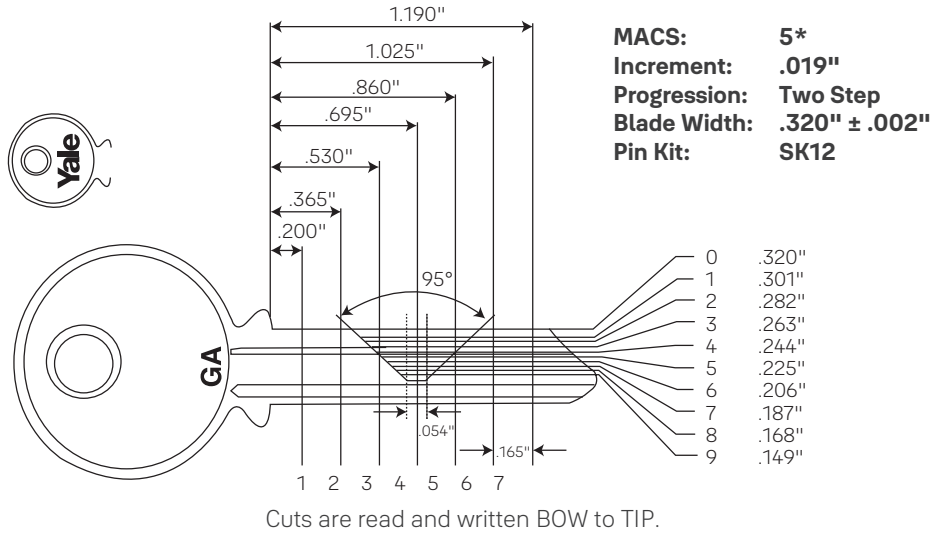

Pinning Formula

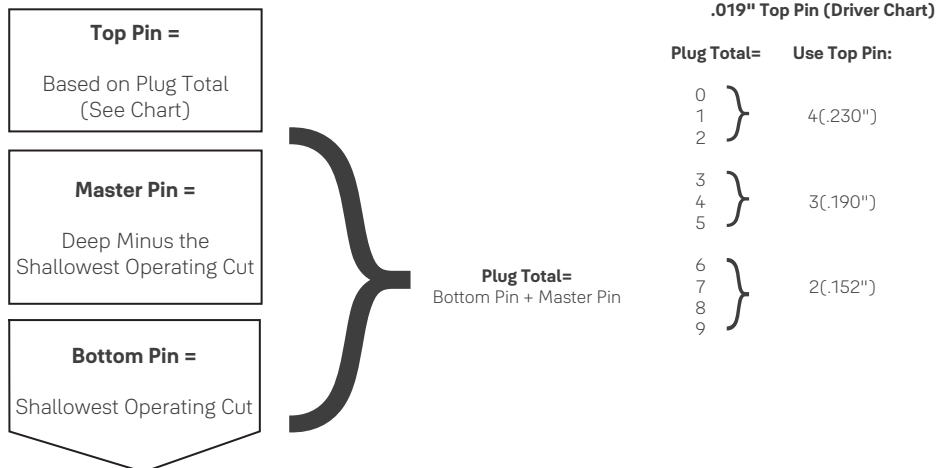

.019" Specifications For Bump Resistant Cylinders

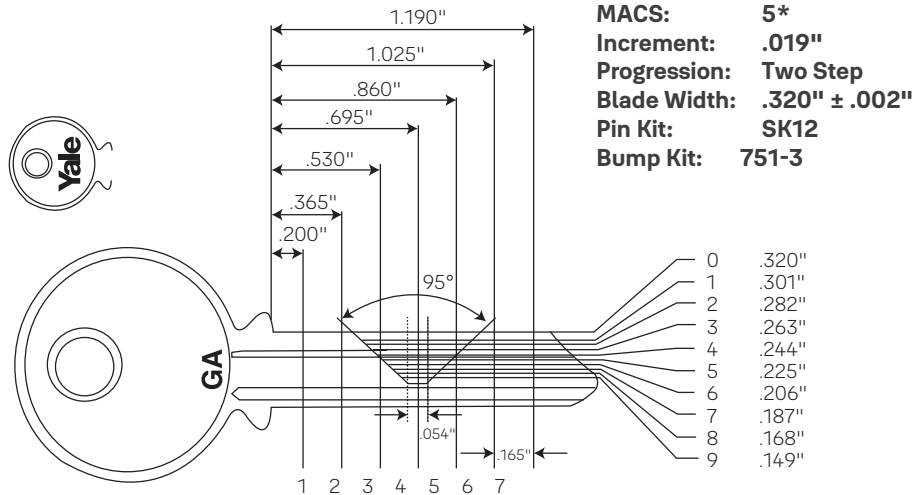

Cuts are read and written BOW to TIP.

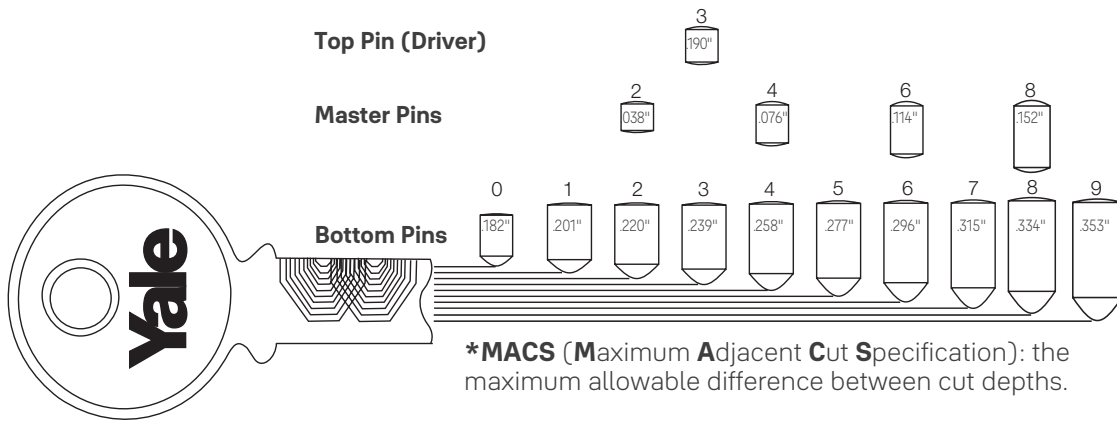

***MACS (Maximum Adjacent Cut Specification):** the maximum allowable difference between cut depths.

Note: Bump resistance is only achieved when all chambers include a bump resistant pin. Illustrations are not drawn to actual size or configuration.

Pinning Formula

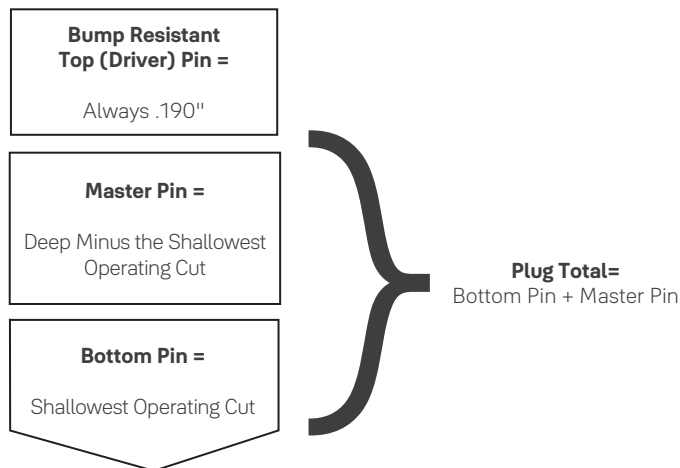



Procedures

Yale® keying systems utilize the Standard Key Coding System illustrated on the following pages. To ensure prompt and accurate processing, purchase orders should be written using these key symbols to describe each master keyed item. In addition to the key symbol, Yale requires the following information on the keying system for ALL orders:

- End User (job) Name
- City, State, Zip Code
- Special key bows or key stamping
- VKC/CKC requirements (see page 4)

Existing System Add-Ons

For prompt processing, orders must include a positive identification for the keying system in addition to the job name, city, state and ZIP code. Any ONE of the following is positive ID:

- Registry number stamped on any existing factory master key
- Previous factory order number together with the year of that order

Letters Of Authorization

No letter is needed when the items are to be drop shipped directly to the end user. In all other cases, to preserve the security of the end user's keying system, Yale requires a letter of authorization on the end user's letterhead to obtain the following:

- Bitting lists
- Security blanks and cut keys
- Master level cut keys
- Patented key blanks, cylinders and plugs

The letter of authorization can be brief but should include a specific description of what is being authorized for release, and a positive key system identification.

XYZ Corporation **1 Main St.**
Anytown, USA 00001
(203) 555-5555

(Current Date)

Yale
Key Systems Dept.

We authorize Acme Distributors to obtain a copy of the bitting list for our keying system R75235. We also authorize them to order the quantities of master keys on our attached purchase order 1234AB.

Sincerely,

Gordon Morris
Security Director

New Systems Or New Branches Of Existing Systems

Indicate system expansion in terms of estimated numbers of key combinations, not doors. All of this information is essential at the inception of a keying system in order for Yale to ensure that the end user's present and future security requirements are met. Advise as follows:

- How many levels of keying?
- Plan for a construction master key?
- Any selective master keys, such as ENG?
- How many changes for each master?
- How many masters for each grand master? If mixing Yale cylinder types, indicate clearly where each type of cylinder will be used within the expansion parameters:
 - Which masters or grands have security cylinders under them?
 - Which have interchangeable cores?
 - Which have conventional cylinders?

ASSA ABLOY FLASHship™ Masterkey Program

The **ASSA ABLOY FLASHship™** program is proud to offer the most comprehensive masterkeying program in the industry. Enjoy the convenience of masterkeying up to 250 Yale cylinders and 200 change keys with 24-hour processing! This simple Level 2 masterkey system is available for Yale cylinders, locks, and exit trim in the PARA keyway.

You can now also expand existing FLASHship Masterkey systems with the easy FLASHship online order entry process. Simply provide either the job name, original FLASHship order number, or the system registry number to order. Please ask your Door Security Solutions sales consultant for a demonstration of the order process.



Designing Master Key Systems

Step 1

Determine the type of locking system

- Conventional "open & restricted keyways"
 - Not contract controlled
- Patented locking system
 - A notice of acceptance will be required between Yale and Owner
 - Factory-based system
 - Key blank distribution restrictions are in place
- Security (secondary locking mechanisms)
- High security (same as Security plus UL437)
- Stand-alone access control locking devices (at door wiring)
 - To facilitate multiple users through common doors
- Integrated locking systems (hard wired into access control systems)

Step 2

Establish the level of the master key system. The higher the level the less secure.

- Level two – "Simple Master Key system"
 - Change key, and master key only
- Level three – "Grand Master Key system"
 - Change key, master key, and grand master key
- Level four – "Great Grand Master Key system"
 - Change key, master key, grand master key
- Levels higher than four are not recommended for security reasons
 - With more levels, additional master pins in each chamber of the cylinder would be required, and with the additional master pins the possibility of unauthorized key interchanges could occur

See pages 32-34 on How to Establish Key Systems.

Step 3

Establish key hierarchy, key issuing policies and procedures, and administrative disciplines.

- Who, if anyone, is authorized to carry the top master key?
- Who carries master keys and change keys?
 - Does every employee receive a key?
- What disciplinary action(s) is being put in place for violations?
 - Fines or Deposits
 - Lost keys
 - Keys not returned
 - Will there be a key receipt required?
 - Where will that be kept?
- Who is the systems administrator?
 - Authorized to purchase
 - Responsible for Key Control Administration
- Who is the Key Control Administrator?
 - Maintain key control software & all transactions

Step 4

System Layout

- Helpful Hints
 - KISS "Keep It Simple System"
 - Do not use the term sub-master (not unless it's level 6 and higher)
- Lowest level possible
- Key to the building security objectives NOT to the people
 - Determine if the system is to be designed for Security or Convenience
- No cross keying, especially with patented locking systems and higher
- Key alike within master key groups as much as possible
 - Avoid top-heavy systems (example; few change keys used under masters)

- Has the right function of lockset been selected?
 - Storeroom vs. Classroom vs. Entry
 - Single cylinder vs. double cylinder
 - If double cylinder, how is the inside cylinder to be keyed?
- Provide adequate quantity of keys
 - Top master keys "limit the number of these to only a few"
 - Master keys "also limit the number these"
 - Change keys per key set and/or per keyed alike sets
 - Special operating keys
 - Control keys "limit the number of these"

Separate the internal departments into sectors, example are:

- Perimeter
 - Including all exterior doors, roof surfaces, gates and fences, and adjacent buildings.
- Operations
 - Sensitive areas crucial to daily operations, such as plant engineering, security and mechanical operations.
- Management
 - Areas that are vital for daily business activities, primarily human resources, administration, executive offices, IT, sales, and accounting.
- Services
 - Areas that provide employees and visitors with services, such as restrooms, medical treatment areas, housekeeping, food service, retail (unless it's a leased outside source).
- Unique Applications
 - Door openings requiring access control hardware where key override is required, or any other special application which would be unique.
- Tenants
 - Any tenants that are not part of the building.

Step 5

Servicing & Maintenance

- In-house or outside locksmith
 - Ensure proper training
 - Establish key cutting log
 - Establish service request procedures
- Service equipment
 - Key kit
 - Code cutter that complies with systems depths & spacing specifications
 - Locksmithing tools, fixtures & accessories
- Establish stock levels & requirements to avoid misuse of multi-section key blanks
 - Additional cylinders ready for emergencies
 - Additional key blanks (of all keyways)
- Who or where are the key blanks going to be kept?
- Who is authorized to cut keys?
 - What form of work order will be used to authorize cutting of keys?
 - Who will sign the work order?
 - What records will be kept & where?
- What type of reports will be required?
 - Overdue keys
 - Miss-cut keys
 - Who receives the reports?
- Once a key has been cut, what instructions are given to the recipient?
 - Key receipt recommended
- Ensure that all transactions are recorded by the Key Control Administrator
- ENFORCEMENT FROM THE START! SUPPORT AND BACK THOSE WHO ARE RESPONSIBLE FOR MAINTAINING AND SERVICING THE SYSTEM.



How To Establish Master Key Systems

Simple Master Key System (2 Levels of Keying)

The master key symbol consists of TWO letters, such as **AA**. The change key numbers are added to the master key letters. The numbers come FIRST: **1AA, 2AA, 3AA**, etc.

When locks are required which are not operated by the master key or other change keys in the system, they are referred to as "single keyed" and given symbols **SKD1, SKD2**, etc. When all higher levels of master keys are to be disallowed, suffix (**NMK**) to the symbol of the key which is to operate. This means "not master keyed." Cylinder **1AA(NMK)** is operated by **1AA** only. The **AA** master is blocked from operation.

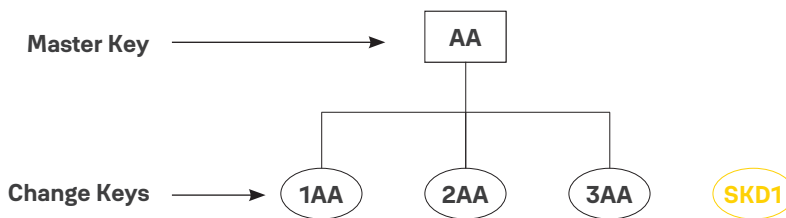

Grand Master Key System (3 Levels of Keying)

The grand master is assigned any ONE letter, such as **A**. The master keys under this grand are assigned TWO letters, the first of which must be the same as the grand: **AA, AB, AC**, etc. are all masters under grand **A**. Caution: Do not use the letters **I, O** or **Q** because of possible confusion with the numerals 1 and 0, respectively. Also do not use the letter **X** due to confusion with cross keying. Change key numbers come after the letters.

If the cylinder is to be operated by its change key and nothing lower than the single lettered GMK, the change number is added to the GMK symbol. This is illustrated by the example **A1** in the schematic shown.

When locks are required which are not operated by ANY master keys or other change keys in the system, they are referred to as "single keyed" and given symbols **SKD1, SKD2**, etc.

When all higher levels of master keys are to be disallowed, suffix (**NMK**) to the symbol of the key which is to operate. This means "not master keyed" and can be applied to any level in the system. Cylinder **AA1 (NMK)** is operated by **AA1** only. The **AA** master and **A** grand are blocked from operation. Cylinder **AA (NMK)** would be operated by the **AA** master only. Grand **A** does not operate.

For master keys beyond **AZ**, insert a numeral between the letters to designate which pass through the alphabet they represent. **A2A** through **A2Z** represents the second pass of masters under grand **A**. **A3A** through **A3Z** would be the third. Change keys under these masters have the numbers suffixed in the usual way: **A2A1, A2A50**, etc.

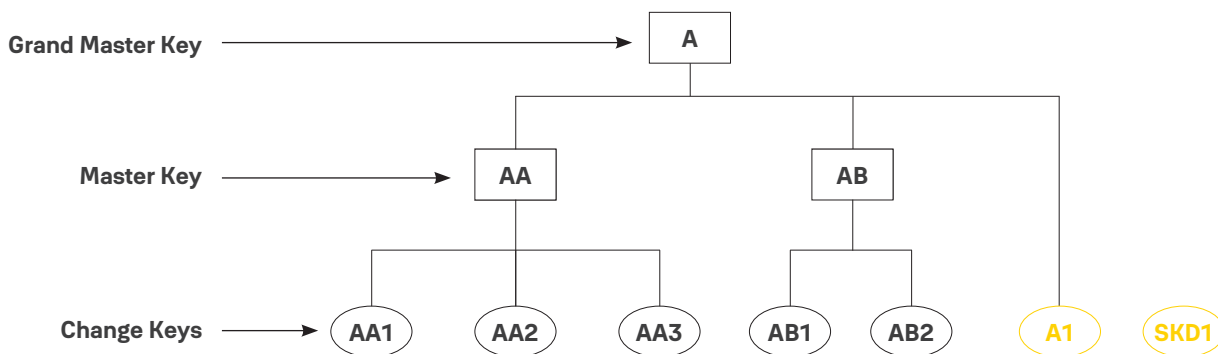



How To Establish Master Key Systems

Great Grand Master Key System (4 Levels of Keying)

The great grand master key is assigned the symbol **GGM**. The rest of the symbols are the same as those in 3-level systems: The GMKs are assigned single letters, e.g., **A, B, C, D**, etc. Caution: Never use **X** for a grand master key due to the confusion which will result with cross keying symbols presented on page 34.

Masters under each GMK are assigned two letters, the first of which is the same as its respective grand master key. Change key numbers come after the letters. Changes under the grand (**A1, B1**, etc.) and masters beyond **AZ** are handled exactly as in the 3-level system already described.

Changes directly under a grand are also handled as illustrated in the 3-level system. For changes directly under the **GGM** with no intermediate level masters, the change number is added directly to **GGM** as shown by the example **GGM1** in the schematic.

When locks are required which are not operated by ANY master keys or other change keys in the system, they are referred to as "single keyed" and given symbols **SKD1, SKD2**, etc.

When all higher levels of master keys are to be disallowed, suffix (**NMK**) to the symbol of the key which is to operate. This means "not master keyed" and can be applied to any level in the system. Cylinder **AA1 (NMK)** is operated by **AA1** only. The **AA** master, **A** grand and **GGM** are all blocked from operation. Cylinder **AA (NMK)** is operated by the **AA** master only. Grand **A** and the **GGM** do not operate. Cylinder **A (NMK)** would be operated by the **A** grand only, without the **GGM**.

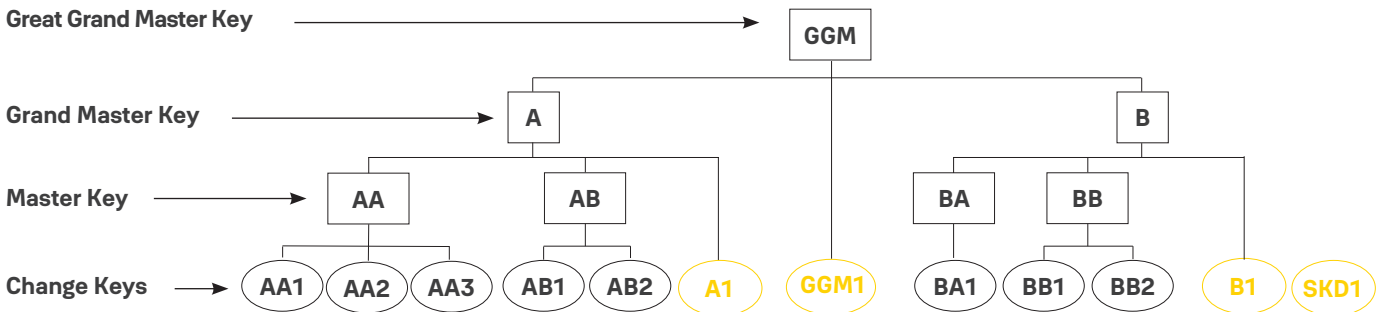

Selective Master Keys

It is often useful in large keying systems to issue a high level master key to maintenance personnel which allows access across all master and grand master key boundaries of a keying system. A selective master key is usually very close to the system's top master key, both physically and through its realm of access. Nevertheless, it must be blocked from operating in many areas.

The most common names and symbols for selective master keys are:

- ENG Engineer's key
- ATT Attendant's key
- JAN Janitor's key
- HKP Housekeeper's key
- GRD Guard's key
- MAIN Maintenance

To designate that a lock be operated by a selective master key, suffix the symbol in parentheses to the standard symbol. Example: **AA1 (ENG)**. This must be added every time the selective key is to operate and left off whenever the selective key is NOT to operate. For instance, you may lay out

a system in which key **AA1** is to operate two different offices. Inside one of them is an electrical cabinet which must be accessible to maintenance personnel carrying the **ENG** key. That lock must be specified as **AA1 (ENG)** while the lock for the other office must be specified as **AA1**. Change keys directly under the selective key, such as **ENG1**, are operated by all higher level keys, such as **GGM**.

Like cross keying, a selective master key is a convenience feature which decreases the security of the cylinders it operates and limits the expansion and flexibility of the overall keying system.

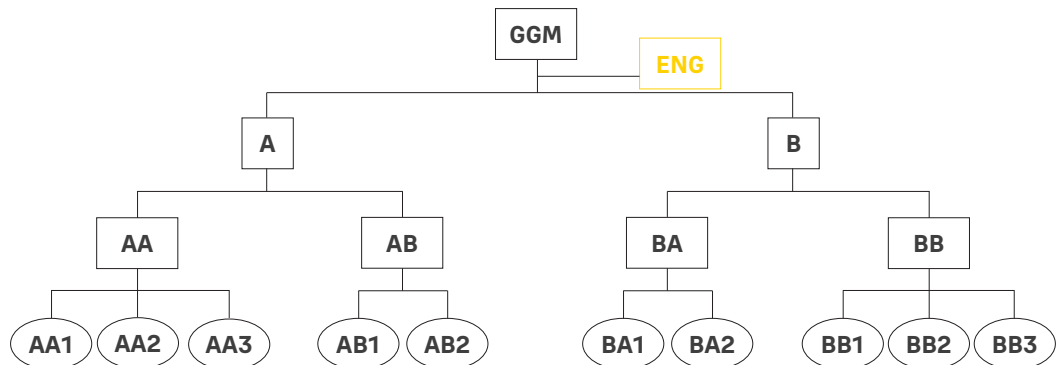

How To Establish Master Key Systems



Convenience May Reduce Cylinder Security and Hinder System Expansion

Whenever two or more different keys such as **AA1** and **AA2** are both required to operate the same cylinder, the cylinder's security is reduced. This is called cross keying. When the cross keying occurs under all the same higher level keys, such as **AA1** and **AA2**, it is known as controlled cross keying. When it combines keys under different higher level keys, such as **AA1** and **AB1**, it is known as uncontrolled cross keying.

In addition to reducing the security of the cylinder, cross keying usually imposes limits on the flexibility and expansion of the overall keying system. This is especially true of uncontrolled cross keying. For these reasons, it is strongly recommended to allow personnel to carry more than one key. Cross keying should be discouraged whenever possible. However, when cross keying is required, it is specified as follows, and should be summarized at the beginning of each order.

Case #1

Cylinder requires its own change key. The illustration depicts part of a small medical building where two doctors share a common receptionist. The receptionist gets the **AA3** key. Each doctor carries a key which operates only one office, but is also cross keyed into the entrance from the corridor.

Determine the symbol of the change key (example: **AA3**). Then prefix the letter X (example: **XAA3**). Then list all keys which are to operate in an "operated by . . ." phrase. Example: "**XAA3** operated by **AA1**, **AA2**, **AA** and **A**". Note that **X** is a cylinder specification only. The keys for cylinder **XAA3** are designated **AA3**.

Case #2

Cylinder does NOT require its own change key. This illustration depicts a section of a floor in a dormitory. Each student's bedroom key operates the hall door lock. There is no need to construct a key which operates only the hall door.

In this case, place an **X** at both the beginning and end of the symbol and a number between them. Example: **X1X**, **X2X**, etc. Again, always include the "operated by . . ." phrase with a complete listing of key symbols to operate.

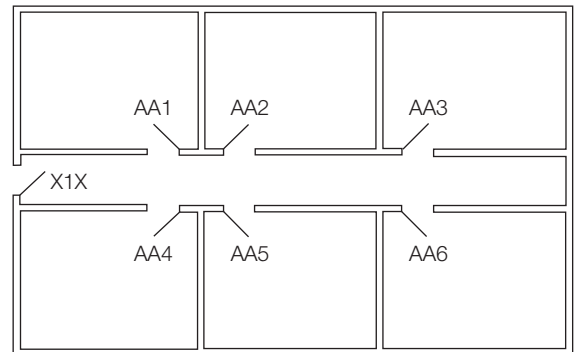

X1X operated by AA1 through AA6, AA and A.





Trusted every day

Phone

1-855-557-5078

Customer Service Email

customerservice.yale@assaabloy.com

Technical Product Support Email

techsupport.yale@assaabloy.com

Order Entry Email

orders.yaleus@assaabloy.com

Fax

1-800-338-0965

Website

www.yalecommercial.com

Contact Us

U.S.A.

Yale Locks & Hardware

Address: 225 Episcopal Road

Berlin, CT 06037-4004

Tel: 1-800-438-1951

Fax: 1-800-338-0965

yalecommercial.com

Canada:

ASSA ABLOY Door Security Solutions Canada

Address: 160 Four Valley Drive

Vaughan, Ontario L4K 4T9

Tel: 1-800-461-3007

Fax: 1-800-461-8989

assaabloydss.ca

International:

ASSA ABLOY Americas International

Tel: 1-905-821-7775

Fax: 1-905-821-1429

assaabloyai.com

THE YALE BRAND, with its unparalleled global reach and range of products, reassures more people in more countries than any other consumer locking solution.

THE ASSA ABLOY GROUP is the world's leading manufacturer and supplier of locking solutions, dedicated to satisfying end-user needs for security, safety and convenience.

Yale Commercial is a business associated with ASSA ABLOY Access and Egress Hardware Group, Inc., an ASSA ABLOY Group company. Copyright © 1998-2021, ASSA ABLOY Access and Egress Hardware Group, Inc. All rights reserved. Reproduction in whole or in part without the express written permission of ASSA ABLOY Access and Egress Hardware Group, Inc. is prohibited. Patent pending and/or patent www.assaabloydss.com/patents.



Yale® KeyMark® Protected Keyway Cylinders

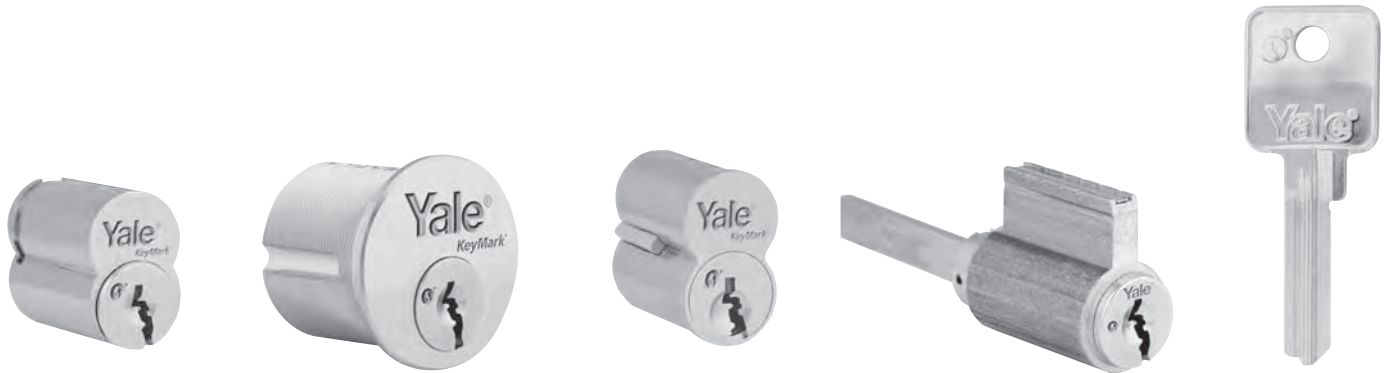



Contents

Overview	3
Keys	4
System Specifications	5
Finishes	6
Cylinder Types.....	7-14
Collars	15
Accessories	16
Construction Core Program	17

Yale® Keymark®

Yale® KeyMark® is a protected keyway line of cylinders. Cylinders include mortise, rim, key-in-lever, key-in-knob, auxiliary, and interchangeable core. Interchangeable core is available in both large and small format. All formats can be tied into one master key system!



Features	Benefits
<ul style="list-style-type: none"> • Unique Yale KeyMark Security Leg® keyway angle 	<ul style="list-style-type: none"> • Will not interchange with KeyMark by Medeco
<ul style="list-style-type: none"> • Protected key control through the Security Leg keyway 	<ul style="list-style-type: none"> • Provides increased resistance against picking and impressioning
<ul style="list-style-type: none"> • Convenient, simple to service 	<ul style="list-style-type: none"> • No extra internal moving parts such as side bars
<ul style="list-style-type: none"> • Available in 6- and 7-pin cylinders 	<ul style="list-style-type: none"> • Can easily retrofit into existing systems
<ul style="list-style-type: none"> • Able to master key SFIC, LFIC and fixed core cylinders to the same keying system 	<ul style="list-style-type: none"> • One key can operate small format IC, as well as large format IC, and fixed core cylinders
<ul style="list-style-type: none"> • Uses common style pins 	<ul style="list-style-type: none"> • No angle tip or interlocking pins which result in loss of keying capacity
<ul style="list-style-type: none"> • Different keying specifications from conventional Yale systems 	<ul style="list-style-type: none"> • Increased master keying capacity over conventional Yale keying systems
<ul style="list-style-type: none"> • New keyways 	<ul style="list-style-type: none"> • Will not interchange with current Yale or KeyMark by Medeco key systems, resulting in increased protection for the owner

Protected

Yale KeyMark keyways are considered as 'protected' by Yale and special procedures are in place to ensure their integrity.

See page 4 for more information.



Applications

Especially recommended for installations requiring protected key control protection. Ideally suited for Educational and Healthcare facilities, Industrial, and Commercial buildings.

Product Specifications

All cylinders to have an angled keyway that accepts a keyblank that is constructed with the same angle. All cylinders shall be available in any of the mortise, rim, cylindrical or interchangeable core types. All cylinder components (excluding tumbler pins and fasteners) shall be constructed of the same material; this material shall be extruded brass. All cylinders shall be capable of utilizing the same key sections and the same key cutting depth and space specification without any loss of keying capacity. Cylinders shall contain standard pins, a portion of which, both bottom and top, shall be spooled for greater resistance against picking.

Certifications

ANSI/BHMA A156.5 Grade 1 
 E09211 (Mortise)
 E09221 (Rim)
 E09231 (Bored Lock Cylinders)



Security Leg®

The Yale® KeyMark® keyway has three distinct components: an upper portion or blade, a middle ledge, and a unique, lower angled portion or leg which exits the plug at an angle.

The Security Leg® keyway offers these advantages:

1. Keyway differentiation by angle
2. Increased picking resistance
3. Prevents other manufacturers' or other angle users' keys from entering the cylinder
4. A unique and strong protected key with true key control
5. A key blank of added thickness for extra strength and durability
6. Prevents duplication of keys on standard key machines

Key Warranty

Yale KeyMark keys are covered by a lifetime warranty against breakage under normal usage conditions. Refer to the current Yale pricebook for additional warranty information.

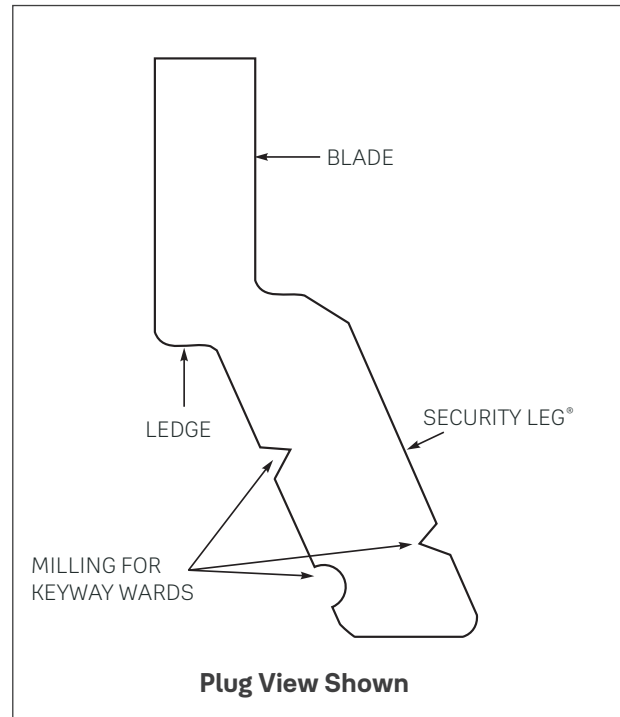

Keys And Key Stamping

KeyBlank Descriptions				
Bow Style	Material	Number	Used For	Keyway
K	N (Nickel Silver)	11	6-pin Master/Change Keys 6-pin SFIC Control Keys	Keyway designations not printed for security reasons. Refer to system bitting list for correct keyway.
		117	7-pin Master/Change Keys 7-pin SFIC Control Keys	
		117C	6-pin LFIC Control Keys	
		118C	7-pin LFIC Control Keys	
		91C	6-pin Schlage® Control Keys	

How to Order Example

Qty.	Description	Keyway
100	KN11	XX

Stamping

All keys will come standard with keybow and stampings as shown. Control keys for LFIC will be furnished with a larger keybow.



Front Side



Back Side

Backside Stamping Options

- Keyset (VKC1) standard – unless otherwise indicated
- System registry number will be stamped on upper-level keys unless otherwise indicated
- Concealed key control (CKC2 only) available on cylinders
- Visual key control (VKC2 and VKC3) not available on cylinders

System Specifications



Keyways

Keyway Administration and Assignment

For security purposes, the keyway hierarchies and profiles are not printed. All keyways will be noted on the master key system bitting list.

Yale® Key Systems Administration will assign all Yale® KeyMark® keyways. Keyways will be assigned according to facility type, geographic location, and keying system specifications. All keys will direct ship to the end user. All master key systems will be registered with Key Systems Administration and all bittings will be factory created.

System Administration & Key Control

Key control will be maintained through compliance with the Yale Security Policy: for a copy contact Key Systems Administration or visit our website at www.yalelocks.com. System information and/or systems related product will be forwarded directly to the owner, unless otherwise indicated by the owner's appointed administrator.

Primary Systems Administrators

All Yale KeyMark master key systems must have a signed Notice of Acceptance for the Facility on file with Key Systems Administration. The Notice of Acceptance designates the primary systems administrator of the facility. Unless otherwise indicated by the primary systems administrator by way of a separate specific letter of authorization, all shipments for Yale KeyMark product will go to the shipping address as per the Notice of Acceptance.

For every master key system that is established, a separate Owner's Binder will be sent directly to the primary systems administrator. This Owner's Binder will include all the information needed by the Facility to maintain the Yale KeyMark master key system, including system-specific Registration Certificates which are required for all future orders to be placed for the system.

All keyblanks to be maintained in the possession of the facility must be accounted for. Any defective, incorrectly cut or damaged key blank must be retained in the facility's possession to be returned to Yale on a quarterly basis.

Keying Specifications

6- or 7-pin with two nickel silver change keys per cylinder. Yale KeyMark cylinders may be furnished uncombined, master keyed, or grandmaster keyed to a specific facility. Keyed random or 0-bitted cylinders are not available. For uncombined, specify UC. UC are furnished less pins, springs, pin covers and keys.

System Specifications









Yale KeyMark uses the A2 pinning specification for all types of cylinders. To ensure the security and integrity of each master key system, the following guidelines should be followed:

- Master key systems are independent and cannot be keyed into existing and/or conventional Yale master key systems.
- Cylinders are to be keyed to factory generated bittings only.
- Master key systems are not to exceed five levels of keying.
- Proper keying nomenclature must be used for all systems.
- Cross keying is not available.
- Construction master keying is not available. See page 17 for construction core program.
- Selective master keys are not recommended. If required, they must be established at the inception of the keying system.

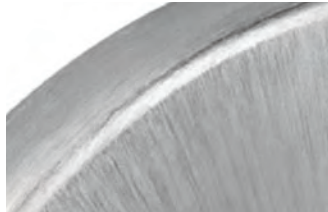

Finishes

Yale KeyMark cylinders are available in the following ANSI/BHMA finishes offered by Yale.

ANSI/BHMA Code Finish Description			
605 Bright Brass, Clear Coated	606 Satin Brass, Clear Coated	612 Satin Bronze, Clear Coated	613 Dark Oxidized Satin Bronze, Oil Rubbed
			
618 Bright Nickel Plated, Clear Coated	619 Satin Nickel Plated, Clear Coated	625 Bright Chrome Plated	626 Satin Chrome Plated
			
BSP Black Suede Powder Coat	WSP White Suede Powder Coat		
			

Plugs are provided in 605, 626 or BSP.



Mortise Cylinders

Fixed Core



Mortise Fixed Core (FC)

For use with mortise and auxiliary locksets.

Cylinder	Length	Pins	Cam
K100	1-1/8" 1-1/4" 1-1/2" 1-3/4" 2"	6 or 7	KC1 (For cam options, see page 16.)
All cylinders are drilled for 7-pins. Length must be specified.			

How To Order Examples

Mortise Cylinder Ordered Separately							
Quantity	Cylinder	Length	Pins	Keyway	Cam	Keyset	Finish
50	K100	1-1/4"	6	XX	KC1	AA1	626
Collar not furnished with cylinder ordered separately.							

Mortise Lockset with a Yale® KeyMark® Cylinder									
Quantity	Trim	Lock	Cylinder	Pins	Keyway	Keyset	Hand	Thickness	Finish
50	AUR	8805FL	K100	6	XX	AA1	RHR	1-3/4"	626
Collar - 1765 furnished standard when ordered with lockset.									

For Collar applications, see page 15.



**Mortise Lock AUR 8805FL
with K100 Cylinder**

Exceptions: Yale® KeyMark® cylinders are not available for the following: 8820, 8820FL, 8827, 8827FL, 8832, 8832FL.

Rim Cylinders



Fixed Core

For use with exit devices and auxiliary locking devices.

Cylinder	Length	Pins	Tailpiece
K300	1-1/8"	6 or 7	KT1 Horizontal Break-off *
*For vertical application change orientation of tailpiece. All cylinders are drilled for 7-pins.			



Rim Fixed Core (FC)

How To Order Examples

Rim Cylinder Ordered Separately						
Quantity	Cylinder	Pins	Keyway	Tailpiece	Keyset	Finish
50	K300	6	XX	KT1	AA1	626
Collar not furnished with cylinder ordered separately.						

Exit Device with a Yale® KeyMark® Cylinder								
Quantity	Device	Trim	Cylinder	Pins	Keyway	Keyset	Hand	Finish
50	7150	626F	K300	6	XX	AA1	RHR	626
For Collar applications, see page 15.								



Heavy-Duty Exit Device Trim 626F with K300 Cylinder and KP4 Collar

Key-In-Knob and Key-In-Lever Cylinders



Fixed Core Component and Interchangeable Core

For use with lever and knob series locksets.

Cylinder	Trim Type	Pins		Tailpiece*
		6	7	
K400	Knob, Yale® 5300, 5400 Series	X	NA**	Na
K402	Lever, Yale 4700LN, 5300LN	X	NA	KT2
K402	Lever, Yale 5400LN, 6400LN Series	X		KT2
			X	KT7
K403-46k	Knob, Yale 4600	X		17-1803-1006 (1.106")
K403-46L	Corbin Russwin CLX3300, SARGENT 10X Line	X		17-1803-1006 (1.106")
K403-46LL	Corbin Russwin CLX3300, SARGENT 10X LINE	X		17-1803-1008 (1.330")
K403A-46L	Corbin Russwin CLX3300, SARGENT 10X LINE		X	17-1803-1007 (.950")
K403A-46LL	Corbin Russwin CLX3300, SARGENT 10X LINE		X	17-1803-1009 (1.174")
K403-47L	Lever, Yale 4700LN, 5400LN, 440F	X		17-1803-1012 (1.930")
K403-53L	Lever, Yale NexTouch®	X		17-1803-1011 (1.700")
K403-54L	Lever, Yale 4600LN, 4800LN, Corbin Russwin CL3100, SARGENT 11 Line	X		17-1803-1005 (.692")
K403A-54L	Lever, Corbin Russwin CL3100, SARGENT 11 Line		X	17-1803-1007 (.536")
K403-54K	Knob/Lever, Yale 5400CK, YH Collection	X		17-1803-1005 (.692")
K404	Knob/Lever, Yale 4300, 4300LN, 4800LN Series	X	NA	KT3
K490	Lever, Schlage® A, D & ND Series	X	NA	KT5

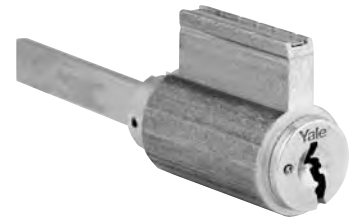

**Key-in-knob (KIK),
Key-in-lever (KIL)
Fixed Core (FC)**

*Length varies by function and application. For tailpiece options, see page 16.

**7-Pin available only for CA design with 5300 and for CA and BR designs with 5400.

How To Order Examples

Component Cylinder Ordered Separately					
Quantity	Cylinder	Pins	Keyway	Keyset	Finish
50	K400	6	XX	AA1	626

Cylindrical Lock with a Yale® KeyMark® Fixed Core Cylinder or IC							
Quantity	Trim	Lock	Cylinder	Pins	Keyway	Keyset	Finish
50	AU	5407LN	K402 (Fixed Core) or *K600 (Small Format IC) - see page 11, or *K800 (Large Format IC) - see page 10.	6	XX	AA1	626

How To Order With Construction Temporary Cores

(See Page 17 For Construction Core Program)



**Heavy-duty Cylindrical Lock
AU5407LN with K800 Core**

Cylindrical Lock with a Temporary LFIC						
Quantity	Trim	Lock	Cylinder	Key Code	Hand	Finish
50	AU	5407LN	1210	CT6LL	RHR	626

For permanent core ordered separately, see "Core Only" on page 10.

Cylindrical Lock with a Temporary, Lockable SFIC						
Quantity	Trim	Lock	Cylinder	Key Code	Hand	Finish
50	B-AU	5407LN	K926	CT6SL	RHR	626

For permanent core ordered separately, see "Core Only" on page 11.

Interchangeable Core Cylinders



Large Format Mortise

Complete Cylinder	Core	Housing	Length	Pins		Cam
				6	7	
K820	Included	Included	1-1/2"	X		KC1 (For cam options, see page 16.)
			1-11/16"		X	
			1-3/4"	X	X	
			2"	X	X	
	K800	K860		X	X	
				X		
				X		
				X	X	
Schlage® LFIC	K890			X	NA	

For use with mortise and auxiliary locksets.



Complete Mortise Cylinder (LFIC)

How To Order Examples

Mortise Cylinder Ordered Separately								
	Quantity	Cylinder	Length	Pins	Keyway	Cam	Keyset	Finish
Complete Cylinder	50	K820	1-1/2"	6	XX	KC1	AA1	626
Housing Only	50	K860	1-1/2"	6	--	KC1	--	626
Core Only	50	K800	--	6	XX	--	AA1	626

Collar not furnished with cylinder ordered separately.



Large Format Interchangeable Core (LFIC)

Mortise Lockset with a Yale® KeyMark® LFIC Cylinder								
Quantity	Trim	Lock	Cylinder	Pins	Keyset	Hand	Thickness	Finish
50	AUR	8805FL	K820	6	AA1	RHR	1-3/4"	626

Collar - 1765 furnished standard when ordered with lockset. For Collar applications, see page 15.

How To Order With Construction Temporary Cores

(See Page 17 For Construction Core Program)

Mortise Lockset with Temporary LFIC							
Quantity	Trim	Lock	Cylinder	Key Code	Hand	Thickness	Finish
50	AUR	8805FL	K825	CT6LL	RHR	1-3/4"	626

For permanent core ordered separately, see "Core Only" above.

Mortise Cylinder Separately with Temporary LFIC					
Quantity	Cylinder	Length	Cam	Key Code	Finish
50	K825	1-1/2"	KC1	CT6LL	626

For permanent core ordered separately, see "Core Only" above.



Mortise Lock AUR 8805FL with K820 Cylinder

Interchangeable Core Cylinders



Small Format Mortise

Complete Cylinder	Core	Housing	Length	Pins		Cam
				6	7	
K620	Included	Included	1-1/4"	X		KC1 (For cam options, see page 16.)
			1-3/8"	X	X	
			1-3/4"	X		
K630 Tapered*	Included	Included	1-1/4"	X		
			1-3/8"	X	X	
	K600			X	X	
Non-Tapered Mortise Housing		K660	1-1/4"	X		
			1-3/8"	X	X	
			1-3/4"	X		
Tapered Mortise Housing		K670	1-1/4"	X		
			1-3/8"	X	X	

For use with mortise and auxiliary locksets.



Complete Mortise Cylinder (SFIC)

*Tapered housings (not illustrated) are designed for narrow stile/backset applications, (storefront doors). Recessed collars are not necessary.

How To Order Examples

Mortise Cylinder Ordered Separately								
	Quantity	Cylinder	Length	Pins	Keyway	Cam	Keyset	Finish
Complete Cylinder	50	K620	1-1/4"	6	XX	KC1	AA1	626
Housing Only	50	K660	1-1/4"	6	--	KC1	--	626
Core Only	50	K600	--	6	XX	--	AA1	626

Collar not furnished with cylinder ordered separately.



Small Format Interchangeable Core (SFIC)

Mortise Lockset with a Yale® KeyMark® SFIC Cylinder									
Quantity	Trim	Lock	Cylinder	Pins	Keyset	Hand	Thickness	Finish	
50	AUR	8805FL	K620	6	AA1	RHR	1-3/4"	626	

Collar - 1765 furnished standard when ordered with lockset. For Collar applications, see page 15.

How To Order With Construction Temporary Cores (See Page 17 For Construction Core Program)

Mortise Lockset with Temporary, Lockable SFIC							
Quantity	Trim	Lock	Cylinder	Key Code	Hand	Thickness	Finish
50	AUR	8805FL	K625	CT6SL	RHR	1-3/4"	626

For permanent core ordered separately, see "Core Only" above.

Mortise Lockset with Temporary, Disposable SFIC							
Quantity	Trim	Lock	Cylinder	Key Code	Hand	Thickness	Finish
50	AUR	8805FL	K625	CT6SD	RHR	1-3/4"	626

For permanent core ordered separately, see "Core Only" above.



Mortise AUR 8805FL with K620 Cylinder

Interchangeable Core Cylinders



Large Format Rim

For use with exit devices and auxiliary locking devices.

Complete Cylinder	Core	Housing	Length	Pins		Tailpiece (TP)
				6	7	
K840	Included	Included	1-7/16"	X	--	KT1 Horizontal Break-off (For vertical application, change orientation of tailpiece)
			1-5/8"	--	X	
		K880	1-7/16"	X	--	
			1-5/8"	--	X	
	K800	--	--	X	X	
Schlage® LFIC	K890	--	--	X	NA	



Complete Rim Cylinder (LFIC)

How To Order Examples

Rim Cylinder Ordered Separately								
	Quantity	Cylinder	Length	Pins	Keyway	TP	Keyset	Finish
Complete Cylinder	50	K840	1-7/16"	6	XX	KT1	AA1	626
Housing Only	50	K880	1-7/16"	6	--	KT1	--	626
Core Only	50	K800	--	6	XX	--	AA1	626

Collar not furnished with cylinder ordered separately.

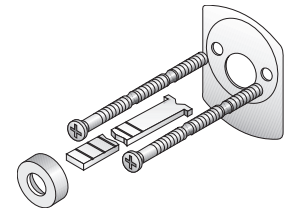

Tailpiece and Mounting Hardware

Exit Device with a Yale® KeyMark® LFIC Cylinder								
Quantity	Device	Trim	Cylinder	Pins	Keyway	Keyset	Hand	Finish
50	7150	626F	K840	6	XX	AA1	RHR	626

For Collar applications, see page 15.

How To Order With Construction Temporary Cores

(See Page 17 For Construction Core Program)

Exit Device with Temporary LFIC						
Quantity	Device	Trim	Cylinder	Key Code	Hand	Finish
50	7150	626F	K845	CT6LL	RHR	626

For permanent core ordered separately, see "Core Only" above.

Rim Cylinder Separately with Temporary LFIC				
Quantity	Cylinder	Tailpiece	Key Code	Finish
50	K845	KT1	CT6LL	626

For permanent core ordered separately, see "Core Only" above.



Heavy-Duty Exit Device Trim 626F with K840 Cylinder and KP4 Collar

Interchangeable Core Cylinders



Small Format Rim

Complete Cylinder	Core	Housing	Length	Pins		Tailpiece (TP)
				6	7	
K640	Included	Included	1-1/4"	X	--	KT1 Horizontal Break-off (For vertical application, change orientation of tailpiece.)
			1-3/8"	X	X	
--	--	K680	1-1/4"	X	--	
			1-3/8"	X	X	
--	K600	--	--	X	X	

For use with exit devices and auxiliary locking devices.



Complete Rim Cylinder (SFIC)

How To Order Examples

Rim Cylinder Ordered Separately								
	Quantity	Cylinder	Length	Pins	Keyway	TP	Keyset	Finish
Complete Cylinder	50	K640	1-1/4"	6	XX	KT1	AA1	626
Housing Only	50	K680	1-1/4"	6	--	KT1	--	626
Core Only	50	K600	--	6	XX	--	AA1	626

Collar not furnished with cylinder ordered separately.

Exit Device with a Yale® KeyMark® SFIC Cylinder								
Quantity	Device	Trim	Cylinder	Pins	Keyway	Keyset	Hand	Finish
50	7150	626F	K640	6	XX	AA1	RHR	626

For Collar applications, see page 15.



Heavy-Duty Exit Device Trim 626F with K640 Cylinder and KP4 Collar

How To Order With Construction Temporary Cores

(See Page 17 For Construction Core Program)

Exit Device with Temporary, Lockable SFIC						
Quantity	Device	Trim	Cylinder	Key Code	Hand	Finish
50	7150	626F	K645	CT6SL	RHR	626

For permanent core ordered separately, see "Core Only" above.

Rim Cylinder Separately with Temporary, Disposable SFIC				
Quantity	Cylinder	Tailpiece	Key Code	Finish
50	K645	KT1	CT6SD	626

For permanent core ordered separately, see "Core Only" above.

Auxiliary Locks/Padlocks



Bored Auxiliary Deadlocks

Cylinder	Used With	Pins		Tailpiece
		6	7	
K202	Yale 4800LN Series	X	NA	KT8
K290	Schlage® "B"	X	NA	KT6

Note: For D series LFIC, refer to page 10 for K800 information.

For use with bored auxiliary deadlocks.

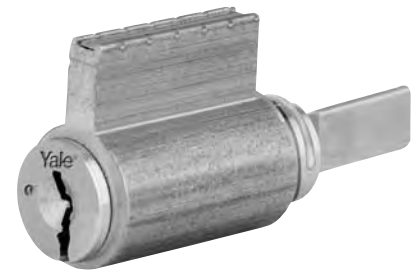

How To Order Examples

Cylinder Ordered Separately						
Quantity	Cylinder	Pins	Keyway	Tailpiece	Keyset	Finish
50	K202	6	XX	KT4	AA1	626

Padlocks

For use with Yale PD500 Series Large or Small Format Interchangeable Core padlocks.

How To Order Examples

Padlock with a Large Format Yale® KeyMark® Core					
Quantity	Lock	Cylinder	Pins	Keyway	Keyset
50	PD524	K800	6	XX	AA1

For How To Order core only, refer to page 10.

Padlock with a Small Format Yale® KeyMark® Core					
Quantity	Lock	Cylinder	Pins	Keyway	Keyset
50	PD515	K600	6	XX	AA1

For How To Order core only, refer to page 11.



Collars



1765 Collar Application Guide For Mortise Lock Standard "Sectional" And All Reflections® Trims



**1765
Solid Recessed**



**KP3
Wave Washer
(Furnished standard with 1765 collar.)**

Cylinder		Door Thickness			
Type	Length	1-3/4"	2"	2-1/4"	2-1/2"
K100	1-1/8"	.312	.187	.062	*
K100	1-1/4"	.375	.281	.125	.062
K620/660					
K620	1-3/8"	.563	.469	.312	.187
K100	1-1/2"	.656	.563	.406	.281
K820/860					
K820/860	1-11/16"	.844	.750	.594	.500

* Indicates cylinder length not sufficient for door/escutcheon thickness; select a longer cylinder.

1765 Collar Application Guide For Mortise Lock "Escutcheon" Trim

Cylinder		Camden				SL or Easton				Lenoir				Copenhagen			
		Door Thickness				Door Thickness				Door Thickness				Door Thickness			
Type	Length	1-3/4"	2"	2-1/4"	2-1/2"	1-3/4"	2"	2-1/4"	2-1/2"	1-3/4"	2"	2-1/4"^^	2-1/2"	1-3/4"	2"	2-1/4"	2-1/2"
K100	1-1/8"	NC	*	*	*	.125	KP4	*	*	.187	NC	NC	*	.187	.094	*	*
K100	1-1/4"	NC	NC	*	*	.156	.094	*	*	.281	.125	.062	NC	.344	.219	.094	*
K620/660																	
K620	1-3/8"	.125	NC^	NC^	*	.375	.250	.156	KP4	.469	.312	.187	.062	.469	.344	.250	KP4
K100	1-1/2"	.250	.125	*	NC	.500	.375	.250	.125	.563	.406	.312	.156	.594	.469	.375	.219
K820/860																	
K820/860	1-11/16"	.469	.344	.219	.062	.719	.563	.469	.312	.750	.594	.469	.375	.844	.656	.531	.406

*Indicates cylinder length not sufficient for door/escutcheon thickness, select a longer cylinder.

^^Single cylinder only

NC=No Collar Required

Collar Application Guide For Exit Device Trim

Cylinder		Trim										
Type	Length	121NL	200	500/510	620/680	630	350/650	660/670				
Rim K300	1-1/8"	1765.250	1765.406	599.544	KP4	1765.250						
K640/680	1-1/4"											
K640/680	1-3/8"								1765.563	599.700	1765.187	1765.406
K840/880	1-7/16"								1765.719		1765.406	1765.500
K840/880	1-5/8"								1765.937	NA	1765.563	1765.719
Mortise/FC K100	1-1/2"						NC	KP4				
Mortise/LFIC K820/K860	1-1/2"						NC	KP4				
K820/K860	1-11/16"						KP4	1765.375				
Mortise/SFIC K620/K660	1-1/4"						NA	NA				
K620/K660	1-3/8"						NA	NC				
K620/K660	1-3/4"						KP4	1765.375				



**KP4
Flush Mount**

Collar sizes are based on 1-3/4" door thickness, for sizes other than those shown contact Yale technical support.



Cams*

Number	Reference
KC1†	2160
KC2	2130
KC3	1161/Schlage® straight
KC4	1160
KC5	1161L (AR)
KC6	1161G (KeySwitch)
KC7	Schlage® cloverleaf
KC8	Corbin Russwin cloverleaf (A01)
KC9	Sargent® Straight
KC10	Yale® Affinity®

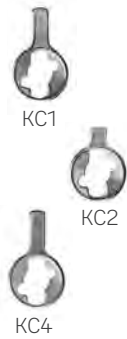

†Furnished standard unless otherwise specified.

Tailpieces

Number	Used With	Remarks
KT1	K300/K840	Rim/LFIC Rim
KT2	K402	6-Pin KIL
KT3	K404	KIL
KT4	K200	Auxiliary
KT5	K490	Schlage® KIL Kit
KT6	K290	Schlage® Auxiliary
KT7	K402	7-Pin KIL
KT8	K202	6-Pin Interconnected Lock

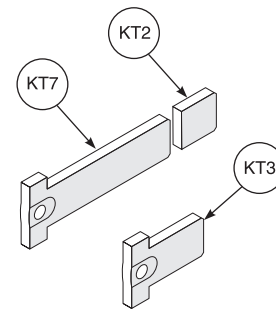

Cylinder Accessories*	
Number	Reference
KP1	Cam Washer
KP2	Screws

*Note: Yale® KeyMark® cams and cylinder accessories are not interchangeable with other Yale® cylinders.

Service Tools

Pin Kit

Each pin kit has all the pins necessary to combine Yale® KeyMark® FC, SFIC and LFIC cylinders.

How To Order

K918

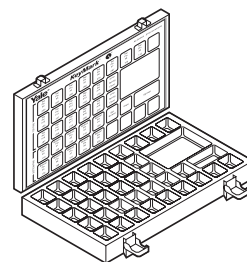

Tools & Fixtures	Number
Key Gauge/Decoder	K915

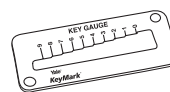

K915



Construction Master Keying

For security reasons, Yale® KeyMark® cylinders are not available construction master keyed. Temporary construction cores are available for both SFIC and LFIC. Temporary cores for SFIC are available with either disposable or locking cores. Temporary cores for LFIC are available with only lockable cores. Please note that temporary cores are not available in competitor formats.

When requesting locksets or cylinders with temporary cores where Yale KeyMark cores will be used for the permanent master key system, the proper ordering procedures must be followed to ensure the issuance of the correct cylinder collars and housings. For all Temporary Construction core orders, both the cylinder and key code designations must be specified. See this page and pages 9-13 for How to Order Examples.

Key Codes	Description
CT6LL	6-pin with large format lockable temporary core
CT6SL	6-pin with small format lockable temporary core
CT6SD	6-pin with small format disposable temporary core
CT7LL	7-pin with large format lockable temporary core
CT7SL	7-pin with small format lockable temporary core
CT7SD	7-pin with small format disposable temporary core

Large Format (LFIC)

Yale's 1210/1220 cores are furnished when the following cylinder designations are used:

Cylinder	Description	Used With
1210	CT6LL	Cylindrical
1220	CT7LL	Cylindrical
K825	Complete Cylinder	Mortise
K845	Complete Cylinder	Rim

All locksets and cylinders ordered with large format interchangeable cores will be provided with keyed alike standard Yale 1210 or 1220 temporary cores. Temporary operating and control keys are required and quantities should be specified. At the completion of the construction phase, these temporary cores can be returned. Refer to the current Yale price book for details. See pages 9-13 for additional examples.

How to Order Example:

Mortise Lockset to be Furnished with Temporary LFIC For the above example, the customer would receive complete mortise locksets with Yale KeyMark K860-1-1/2" housings, 1765.594 collars and 6-pin Yale 1210 keyed alike core. The Yale KeyMark permanent cores, K800, would be ordered separately.

Qty.	Trim	Lock	Cylinder	Key Code	Hand	Thickness	Finish
50	AUR	8805FL	K825	CT6LL	RHR	1-3/4"	626

Small Format (SFIC)

Small format temporary cores can be provided with two options: Disposable or Lockable.

Either disposable or K926 (6-pin lockable) cores are furnished when the following cylinder designations are used:

Cylinder	Description	Used With
K925	6/7-pin Disposable Thumb Turn Only	Cylindrical
K926	6/7-pin Lockable Core Only	Cylindrical
K625	Complete Cylinder	Mortise
K635	Complete Cylinder	Mortise-Tapered
K645	Complete Cylinder	Rim

Option 1: Disposable SFIC (K925)

All locksets and cylinders will be provided with disposable thumb-turn type cores. No keys are required. These cores are disposable and cannot be returned. See pages 11 and 13 for additional examples.

How to Order Example:

Mortise Lockset to be Furnished with Temporary, Disposable SFIC For the above example, the customer would receive complete mortise locksets with Yale KeyMark K660 – 1-1/4" housings, 1765.375 collars and disposable thumb-turn cores, K925. The Yale KeyMark permanent cores, K600, would be ordered separately.

Qty.	Trim	Lock	Cylinder	Key Code	Hand	Thickness	Finish
50	AUR	8805FL	K625	CT6SD	RHR	1-3/4"	626

Option 2: Lockable SFIC (K926)

All locksets and cylinders will be provided with keyed alike standard SFIC cores that are unrelated to the permanent master key system. Temporary operating and control keys are required, quantities must be specified. At the completion of the construction phase, these temporary cores can be returned. See pages 11 and 13 for additional examples.

How to Order Example:

Exit Device to be Furnished with Temporary, Lockable SFIC For the above example, the customer would receive complete exit devices and trim with Yale KeyMark K680 housings, KP4 collars and temporary locking SFIC cores, K926. The Yale KeyMark permanent cores, K600, would be ordered separately.

Qty.	Device	Trim	Cylinder	Key Code	Hand	Finish
50	7150	626F	K645	CT6SL	RHR	626

How To Order

Systems requiring SFIC temporary cores must be ordered either completely with disposable, or lockable cores. Locksets and /or cylinder on a particular purchase order may not be mixed with SFIC temporary core types.

Lockable SFIC cores, K926, and disposable SFIC cores, K925, may be purchased separately. Refer to the Yale KeyMark pricing tab for details.



Trusted every day

Phone

1-855-557-5078

Customer Service Email

customerservice.yale@assaabloy.com

Technical Product Support Email

techsupport.yale@assaabloy.com

Order Entry Email

orders.yaleus@assaabloy.com

Fax

1-800-338-0965

Website

www.yalecommercial.com

Contact Us

U.S.A.

Yale Locks & Hardware

Address: 225 Episcopal Road

Berlin, CT 06037-4004

Tel: 1-800-438-1951

Fax: 1-800-338-0965

yalecommercial.com

Canada:

ASSA ABLOY Door Security Solutions Canada

Address: 160 Four Valley Drive

Vaughan, Ontario L4K 4T9

Tel: 1-800-461-3007

Fax: 1-800-461-8989

assaabloydss.ca

International:

ASSA ABLOY Americas International

Tel: 1-905-821-7775

Fax: 1-905-821-1429

assaabloyai.com

THE YALE BRAND, with its unparalleled global reach and range of products, reassures more people in more countries than any other consumer locking solution.

THE ASSA ABLOY GROUP is the world's leading manufacturer and supplier of locking solutions, dedicated to satisfying end-user needs for security, safety and convenience.

Yale Commercial is a business associated with ASSA ABLOY Access and Egress Hardware Group, Inc., an ASSA ABLOY Group company. Copyright © 2002-2021, ASSA ABLOY Access and Egress Hardware Group, Inc. All rights reserved. Reproduction in whole or in part without the express written permission of ASSA ABLOY Access and Egress Hardware Group, Inc. is prohibited. Patent pending and/or patent www.assaabloydss.com/patents.



8800 Series

ANSI/BHMA Grade 1 Certified Mortise Locks





Contents

Benefits & Features.....	3-4
SL8800	4
How to Order.....	5
Finishes.....	6
Lever Trim	7-10
Reflections® Decorative Trim.....	11-12
Knob Trim.....	13
Mechanical Functions	14-19
Indicators	20-25
Electrified Mortise Locksets.....	26
Electrified Mortise Lockset Functions.....	27-28
Electrified Mortise Lockset Accessories	29
Cylinders.....	30-32
Cylinder Collars.....	33-40
Strikes	41
Miscellaneous.....	42
Handing	43
Dimensions	44
Installations.....	45
Technical Specifications & Listings	46

8800 Series Mortise Locks

Yale® 8800 Series Mortise Locks are designed and manufactured for uncompromising strength and durability in a range of commercial applications. Lock installation is made easy with quick lever handing, field reversible latchbolt and standard non-handed strike. Once installed, the 8800 Series Mortise Lock offers a new measure of security, featuring a reinforced stainless steel deadbolt, heavy-duty, vandal-resistant trim and ANSI/BHMA Grade 1 certification for long life and durability. The 8800 Series Mortise Lock is even backed by a 10 year mechanical warranty, making this product completely worry-free.

When you can't compromise on the quality of your security, Yale Works for YouSM.



Secure:
Stainless steel reinforced deadbolt

Easy and flexible installation:
Field reversible lever handing and latchbolt

Resistant to abuse:
Heavy-duty trim prevents damage

No visible screws:
Great deterrent to vandalism

Indicator available:
Options to suit any application, see page 20



Hurricane



Features



Features

- Heavy-duty trim for resistance against damage and vandalism
- Functions available for any industrial or commercial application
- Field adjustable lever handing and latchbolt
- ANSI/BHMA Certified Grade 1 for long-life and durability
- UL/cUL listed for 3 hour fire rated doors
- 10 year mechanical warranty
- Available in a variety of attractive trims and finishes
- Status indicator options available to provide peace of mind on the locked/unlocked status of a door



Escutcheon Trim



Rose/Sectional Trim

Applications

- Offices
- Shopping centers
- Industrial buildings
- Commercial facilities

Specifications

Armor Front	8" x 1-1/4"
Backset	2-3/4" only
Case	Wrought steel, zinc dichromated
Deadbolt	1" throw, cast stainless steel.
Door Thickness	1-3/4" standard, available for up to 3-1/4" thick doors
Handing	Field reversible
Hubs	3/8" solid steel, fine-blanked and heat treated for additional strength
Latchbolt	3/4" throw, stainless steel one-piece anti-friction
Strike	1-1/4" (model 2815) curved lip strike standard, see page 41 for additional options.

SL8800

For more heavy-duty applications, the SL8800 Series Mortise Lock offers an extra measure of security. The SL8800 is ideal for situations where heavy abuse or vandalism might be a concern. The SL8800 is available in most mortise lock functions; please see pages 14-19 for more information.

Features

- Heavy duty escutcheon trim that is flat against the door to resist damage and vandalism
- Lever attached directly to escutcheon for added security
- Thrubolted security head screws offer added protection



Applications

- Schools
- Minimum security prisons
- High crime areas
- SL trim available in 630 finish only.

How To Order



Trim Design	Lock Series/Function	Cylinder	Hand	Door Thickness	Finish	Highest Keying Level	Supplementary Specifications/Options <small>Please add to end of order string.</small>
See pages 7-13	See pages 14-19	2153 cylinder standard, see pages 30-32 for additional options. If other than the standard cylinder is required, please specify by model number.	RH LH	1-3/4" standard, please specify if different door thickness required	See page 6 YMS = MicroShield®	"Level One" - KA or KD "Level Two" - MK "Level Three" - GM "Level Four" - GGM	<ul style="list-style-type: none"> • Lead lined (see page 46) • Knurled (see page 46) • Abrasive coated • Specific keying • 7-pin cylinders (see page 30) • Specific strike requirements, i.e. special lip length, curved, open back (see page 41) • For split finishes, please specify in detail. Indicate outside finish first regardless of hand of door. For RHR and LHR doors indicate the finish desired for front and strike. - Voltage for electrified (see page 26-29)

















Ordering Example

AU x CN x 8807FL x 2153 x RH x 1-3/4" x 626 x GM

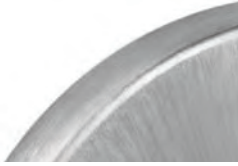
Finishes



The Yale® 8800 Series Mortise Lock is available in the finishes below. All knobs, lever handles, roses, escutcheons, cylinder collars and other exposed parts are fabricated of either brass, stainless steel or zinc and will be compatible with the finish ordered. When ordering, specify the finish required by the ANSI/BHMA Code Number only. When locksets are ordered with different trim finishes on each side, specify the outside finish first, i.e. AUR8817-2 x 612 x 625. The front and strike finish will match the inside finish unless specified otherwise.

ANSI/BHMA Code Finish Description				
605 Bright Brass, Clear Coated	606 Satin Brass, Clear Coated	609 Satin Brass, Blackened, Satin Relieved, Clear Coated	611 Bright Bronze, Clear Coated	612 Satin Bronze, Clear Coated
				
613E Dark Oxidized Satin Bronze - equivalent	616 Satin Bronze, Blackened, and Satin Relieved, Clear Coated	618 Bright Nickel Plated, Clear Coated	619* Satin Nickel Plated, Clear Coated	620 Satin Nickel Plated, Blackened, Satin Relieved, Clear Coated
				
625 Bright Chrome Plated	626* Satin Chrome Plated	629 Bright Stainless Steel	630* Satin Stainless Steel	693 Black Painted
				
BSP Black Suede Powder Coat	WSP White Suede Powder Coat			
				

Notes:

613 and 722 finishes available by Special Product Application Request only. Please contact customer service for more information.

Designer trims are available in only the following finishes: 605, 606, 619, 625, 656. SL trim only available in 630 finish only. Reflections® decorative levers are NOT available in the following finishes: 609, 616, 620, 693.

*Finish available with MicroShield® antimicrobial coating, additional finishes by special application. Consult factory for availability.

MicroShield coating may vary finish color from architectural standards. MicroShield is not intended as a substitute for traditional infection control programs such as hand hygiene or use of disinfectants. Coated products must still be cleaned to ensure the surfaces will be free of destructive microbes. Yale makes no representations or warranties, express or implied, as to the efficacy of MicroShield.



Lever Trim

Standard Rose

Arcadia - ARR

AR Lever Handle*: Cast
 CO Rose**: Stamped
 Cylinder Collar: See pages 33-40

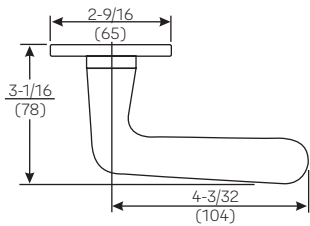

Augusta - AUR

AU Lever Handle: Cast
 CO Rose**: Stamped
 Cylinder Collar: See pages 33-40

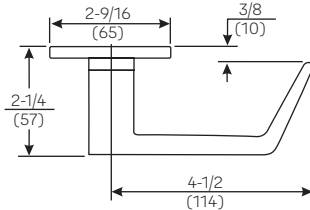

Carmel - CRR

CR Lever Handle: Cast
 CO Rose**: Stamped
 Cylinder Collar: See pages 33-40

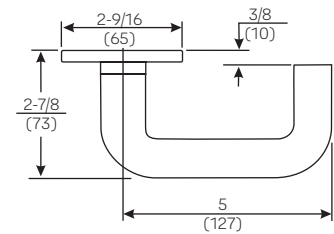

Standard Escutcheon

Arcadia - AR X CN

AR Lever Handle*: Cast
 CN Escutcheon**: Cast
 Cylinder Collar: See pages 33-40

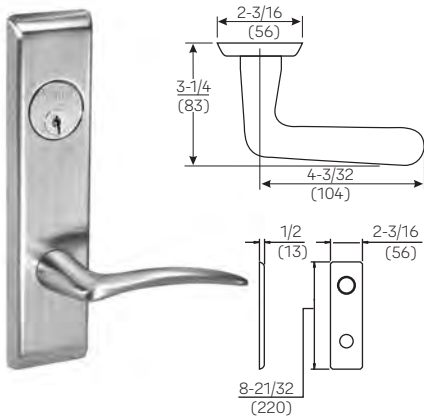

Trim also available for SL Series, specify ARSL.

Augusta - AU X CN

AU Lever Handle: Cast
 CN Escutcheon**: Cast
 Cylinder Collar: See pages 33-40

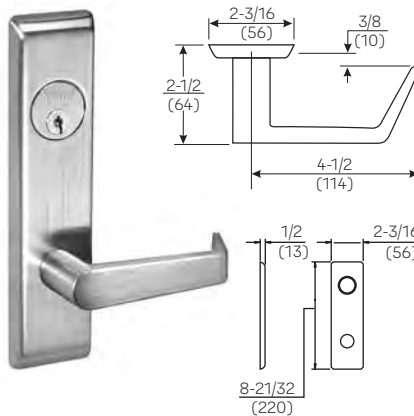

Trim also available for SL Series, specify AUSL.

Carmel - CR X CN

CR Lever Handle: Cast
 CN Escutcheon**: Cast
 Cylinder Collar: See pages 33-40

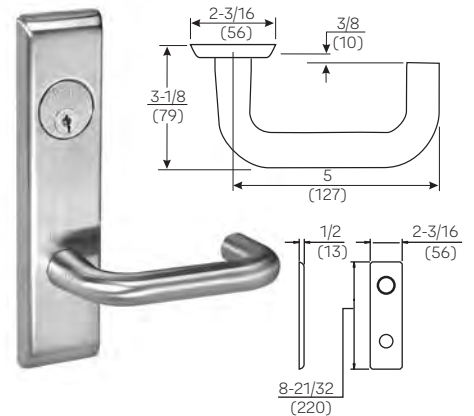

Trim also available for SL Series, specify CRSL.

*Indicates levers that are handed.

**Available with Reflections® rose or escutcheon. See page 12 for options.

Lever Trim



Standard Rose

Jefferson - JNR

JN Lever Handle: Cast
 CO Rose**: Stamped
 Cylinder Collar: See pages 33-40

Monroe - MOR

MO Lever Handle: Cast
 CO Rose**: Stamped
 Cylinder Collar: See pages 33-40

Pacific Beach - PBR

PB Lever Handle: Cast
 CO Rose**: Stamped
 Cylinder Collar: See pages 33-40

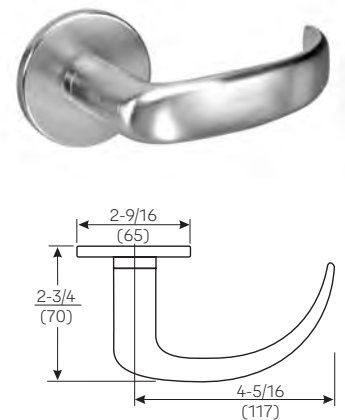
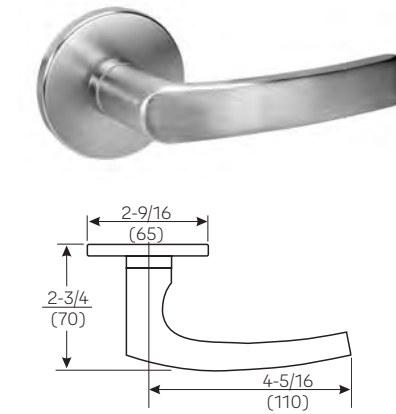
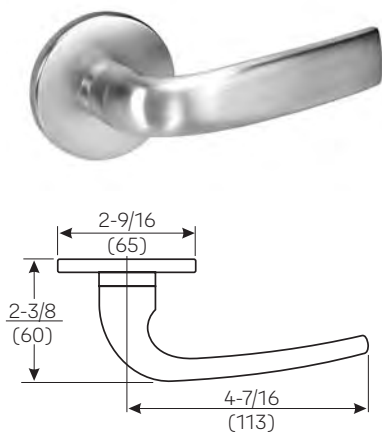

Standard Escutcheon

Jefferson - JN X CN

JN Lever Handle: Cast
 CN Escutcheon¹: Cast
 Cylinder Collar: See pages 33-40

Monroe - MO X CN

MO Lever Handle: Cast
 CN Escutcheon¹: Cast
 Cylinder Collar: See pages 33-40

Pacific Beach - PB X CN

PB Lever Handle: Cast
 CN Escutcheon¹: Cast
 Cylinder Collar: See pages 33-40

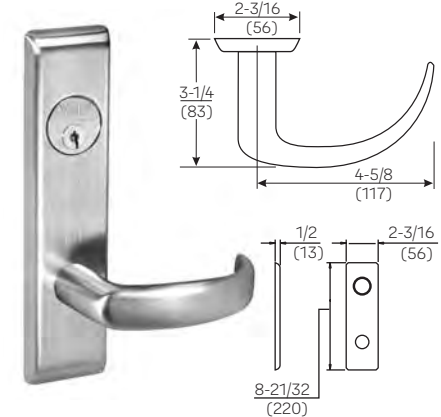
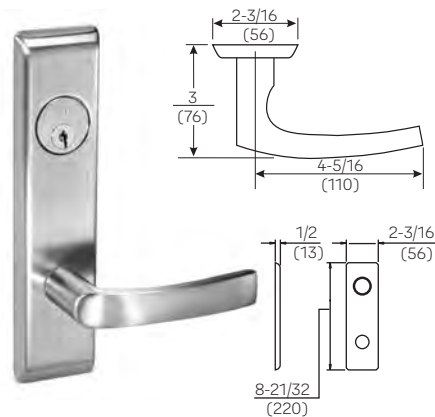
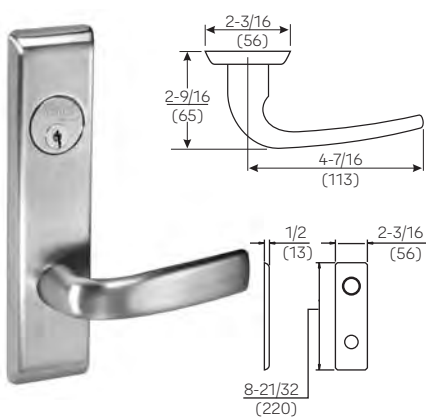

Trim also available for SL Series, specify JNSL.

Trim also available for SL Series, specify MOSL.

Trim also available for SL Series, specify PBSL.

*Indicates levers that are handed.

**Available with Reflections® rose or escutcheon. See page 12 for options.



Lever Trim

Standard Rose

Pinehurst - PNR

PN Lever Handle: Cast
 CO Rose**: Stamped
 Cylinder Collar: See pages 33-40

Virginia - VIR

VI Lever Handle: Cast
 CO Rose**: Stamped
 Cylinder Collar: See pages 33-40

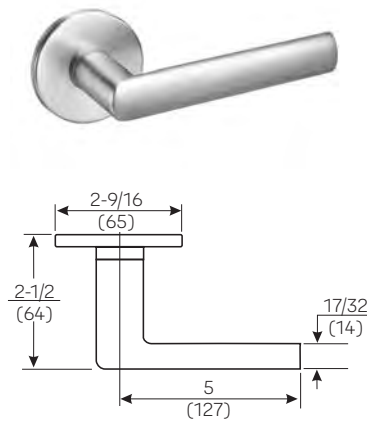
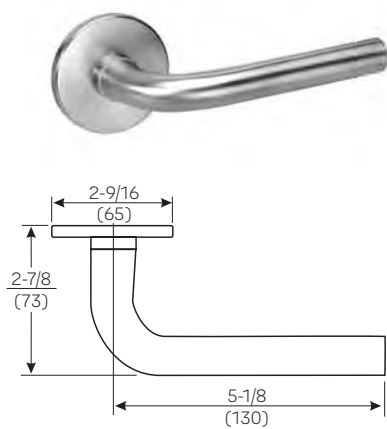

Standard Escutcheon

Pinehurst - PN X CN

PN Lever Handle: Cast
 CN Escutcheon**: Cast
 Cylinder Collar: See pages 33-40

Virginia - VI X CN

VI Lever Handle: Cast
 CN Escutcheon**: Cast
 Cylinder Collar: See pages 33-40

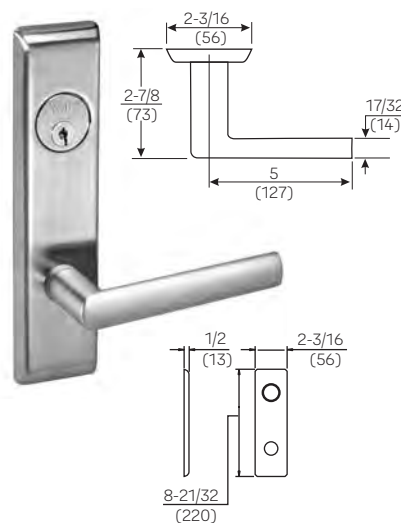
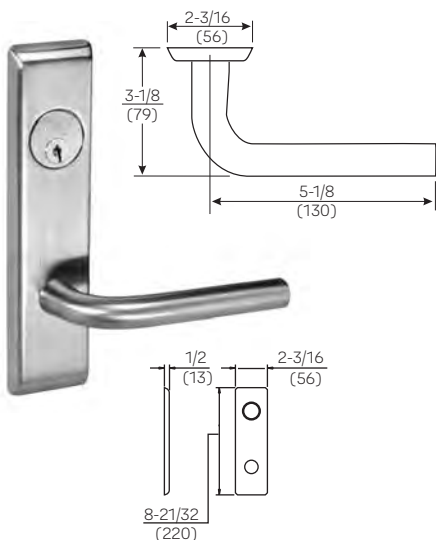

Trim also available for SL Series, specify VISL.

*Indicates levers that are handed.
 **Available with Reflections® rose or escutcheon. See page 12 for options.

Lever Trim



Designer Trim

Hampton - HA

HA Lever Handle: Cast
E3 or E4 Escutcheon: Cast

HA Lever Handle: Cast
R3, R4, R5, R6, R7 or R8 Rose: Cast



E3



R5

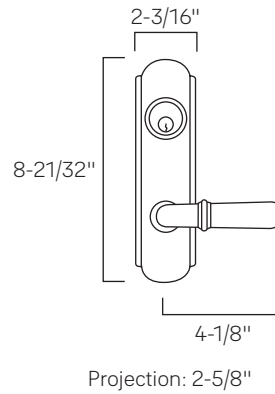

Escutcheons, Roses and Parts



E3

E4



R3

R5



Emergency Release



Thumbturn
1-1/2" x 1"
Projection

Designer trims are available in only the following finishes: 605, 606, 619, 625, 626. When ordering, include the design symbol (i.e. HA) and specific rose or escutcheon symbol (R3-R8, E3 or E4. See page 12 for more information.). An example of a complete symbol, including lever design, would be HAE3. Escutcheon E3 and Rose R5 are shown with above lever designs. Levers are also available for use with standard CO rose and/or CN escutcheon as shown on pages 7-9.

Reflections® Decorative Trim



Yale® 8800RL Mortise Locks are available with Reflections lever trim, a comprehensive line of highly stylized lever handles. Reflections lever handles are made from solid brass or stainless steel and can withstand years of abuse. Available in an array of finishes, these levers complement any wood grain or other door exterior. Each lever is hand-polished and specially designed for ergonomics and style.

Hudson	Spree	Seine	Thames	Victoria	Niagara
TB 	RS 	TE 	TM 	TT* 	CH*
UB 	RT 	TG* 	TN 	TU* 	DW
TC 	RU 	TI 	TP 	TV* 	MA*
TD 	RV 	TJ* 	TR 	TW* 	RA*
UC 		TK* 	TS 	UW* 	RB*
		TO* 	TQ 	TX* 	RC*
				UX* 	
				TY* 	
				TZ* 	

*Indicates levers that are handed.

Note: The following Reflections levers are not available in 629 or 630 finish: Victoria TT, TU, TV, TW, TX, TY, UW, UX, TZ; Seine TG, TJ, TK, TO, TE, TI. Please consider the 618 or 619 finish as an alternative. Reflections levers are not available with knurling option.

Reflections® Decorative Trim



Reflections® Roses

R3

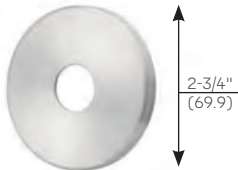

R4

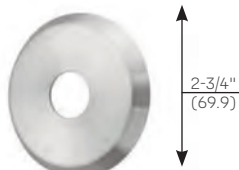

R5

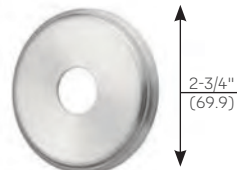

R6

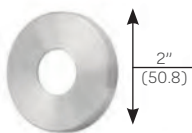

R7

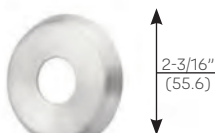

R8

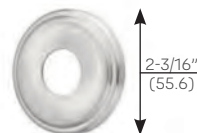

Reflections® Escutcheons

E3



E4



Note: Reflections levers are also available for use with CO rose and/or CN escutcheon as shown on pages 7-9.



Knob Trim

Standard Rose

Copenhagen - COR

CO Knob: Cast
 CO Rose¹: Stamped
 Cylinder Collar: See pages 33-40

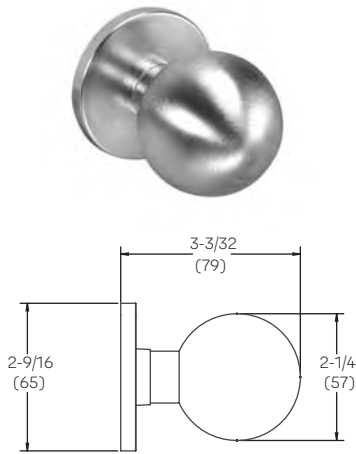

Standard Escutcheon

Copenhagen - CO X CN

CO Knob: Cast
 CN Escutcheon¹: Cast
 Cylinder Collar: See pages 33-40

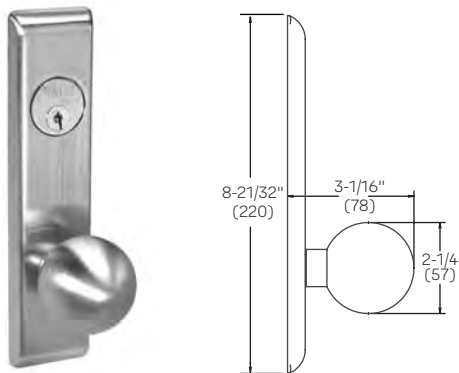

1. Available with Reflections® rose or escutcheon. See page 12 for options.

Mechanical Functions



8801 Passage Or Closet Latch (F01)

- For doors that do not require locking
- Latchbolt retracted by knob/lever either side at all times

Trim	Model Numbers		Latchbolt Throw
	Knobs	Levers	
Standard	8801K	8801FL	3/4"
SL	—	SL8801FL	3/4"
Reflections*	—	8801RL	3/4"

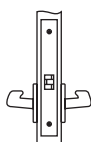

8802 Privacy, Bedroom Or Bath Lock (F19)

- Latchbolt retracted by knob/lever either side
- Deadbolt operated by thumbturn inside
- When the deadbolt is projected, outside knob/lever is automatically locked
- Anti-panic operation. Operating inside knob/lever retracts the latchbolt and deadbolt simultaneously, automatically unlocking outside knob/lever.
- In emergency, deadbolt may be unlocked from outside by E203 emergency key, supplied

Trim	Model Numbers		Throw	
	Knobs	Levers	Latchbolt	Deadbolt
Standard	8802K	8802FL	3/4"	1"
SL	—	SL8802FL	3/4"	1"
Reflections*	—	8802RL	3/4"	1"

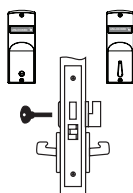

8805 Storeroom Or Closet Lock (F07)

- For use on storeroom, utility, exit doors
- Latchbolt retracted by key outside, knob/lever inside
- Outside knob/lever rigid at all times
- Inside knob/lever always active
- Deadlocking latchbolt

Trim	Model Numbers		Latchbolt Throw
	Knobs	Levers	
Standard	8805K	8805FL	3/4"
SL	—	SL8805FL	3/4"
Reflections*	—	8805RL	3/4"



8807 Entry Lock (F04)

- For office doors where locking is required
- Latchbolt retracted by knob/lever either side, except when outside knob/lever is locked by stopwork activator
- When outside knob/lever is locked, latchbolt is operated by key outside and knob/lever inside
- Deadlocking latchbolt

Trim	Model Numbers		Latchbolt Throw
	Knobs	Levers	
Standard	8807K	8807FL	3/4"
SL	—	SL8807FL	3/4"
Reflections*	—	8807RL	3/4"

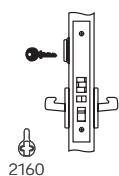

8808 Classroom Lock (F05)

- For classroom, office, or utility room doors
- Latchbolt retracted by knob/lever either side, except when outside knob/lever is locked by key
- Inside knob/lever always active
- Latchbolt can be retracted by key when outside knob/lever is locked
- Operating inside knob/lever retracts latchbolt, but outside knob/lever remains locked
- Deadlocking latchbolt

Trim	Model Numbers		Latchbolt Throw
	Knobs	Levers	
Standard	8808K	8808FL	3/4"
SL	—	SL8808FL	3/4"
Reflections*	—	8808RL	3/4"

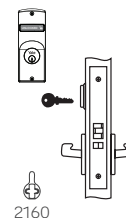

8808-2 Intruder Latchbolt Lock (F32)

- Latchbolt retracted by knob/lever either side unless outside knob/lever is locked by key
- Either cylinder locks or unlocks outside knob/lever
- Latchbolt can be retracted by key when outside knob/lever is locked
- Operating inside knob/lever retracts latchbolt, but outside knob/lever remains locked
- Deadlocking latchbolt

Trim	Model Numbers		Latchbolt Throw
	Knobs	Levers	
Standard	8808-2K	8808-2FL	3/4"
SL	—	SL8808-2FL	3/4"
Reflections*	—	8808-2RL	3/4"

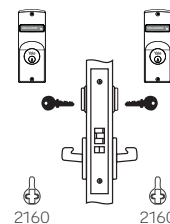

8809 Classroom Or Office Lock

- Latchbolt retracted by knob/lever either side unless outside knob/lever is locked by key outside or thumbturn inside
- Latchbolt retracted by thumbturn inside or key outside
- Inside knob/lever always active
- Deadlocking latchbolt

Trim	Model Numbers		Latchbolt Throw
	Knobs	Levers	
Standard	8809K	8809FL	3/4"
SL	—	SL8809FL	3/4"
Reflections*	—	8809RL	3/4"

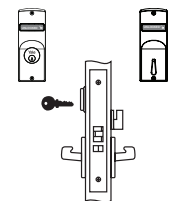

8811-2 Intruder Deadbolt Lock (F33)

- Latchbolt retracted by knob/lever either side unless outside knob/lever is locked by key
- Deadbolt operated by key either side
- When deadbolt is projected, outside knob/lever is automatically locked
- Key retraction of deadbolt unlocks outside knob/lever
- Anti-panic operation. Operating inside knob/lever retracts the latchbolt and deadbolt simultaneously, automatically unlocking outside knob/lever.

Trim	Model Numbers		Throw	
	Knobs	Levers	Latchbolt	Deadbolt
Standard	8811-2K	8811-2FL	3/4"	1"
SL	—	SL8811-2FL	3/4"	1"
Reflections*	—	8811-2RL	3/4"	1"

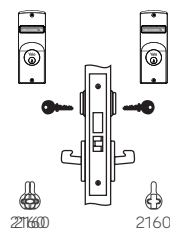

Indicator options available for both sectional and escutcheon trim.

Cylinder cam required.

Indicates rigid knob/lever.



Mechanical Functions

8812-2 Intruder Deadbolt Lock (F34)

- Latchbolt retracted by knob/lever either side unless outside knob/lever is locked by key
- Deadbolt operated by key either side
- When deadbolt is projected, outside knob/lever is automatically locked
- Key retraction of deadbolt unlocks outside knob/lever
- Anti-panic operation. Operating inside knob/lever retracts the latchbolt and deadbolt simultaneously, automatically unlocking outside knob/lever.
- Deadlocking latchbolt

Trim	Model Numbers		Throw	
	Knobs	Levers	Latchbolt	Deadbolt
Standard	8812-2K	8812-2FL	3/4"	1"
SL	—	SL8812-2FL	3/4"	1"
Reflections*	—	8812-2RL	3/4"	1"

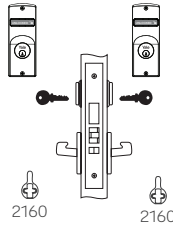

8814-2 Deadlock (F16)

- Deadbolt operated by key either side
 - NOT UL listed
- Note: Use only on rooms with more than one exit
Indicators available for sectional trim only

Model Number	Deadbolt Throw
8814-2	1"

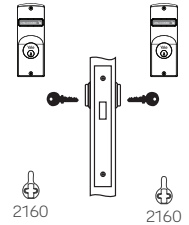

8813ST Classroom Deadlock (F29)

- Deadbolt operated by key outside, thumbturn inside
- Thumbturn inside will retract the deadbolt but will not project it
- NOT UL listed

Model Number	Deadbolt Throw
8813ST	1"



8815 Deadlock (F17)

- Deadbolt operated by key outside, thumbturn inside
 - NOT UL listed
- Note: Indicators available for sectional trim only

Model Number	Deadbolt Throw
8815	1"

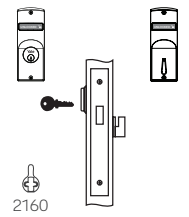

8813ST-2 Classroom Deadlock

- Deadbolt operated by key either side
- Thumbturn inside will retract the deadbolt but will not project it
- NOT UL listed

Model Number	Deadbolt Throw
8813ST-2	1"

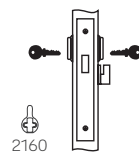

8817-2 Apartment, Exit Or Public Toilet Lock (F09)

- Latchbolt retracted by knob/lever either side, except when outside knob/lever is locked by key inside
- When outside knob/lever is locked, latchbolt is operated by key outside and knob/lever inside
- Deadlocking latchbolt

Trim	Model Numbers		Latchbolt Throw
	Knobs	Levers	
Standard	8817-2K	8817-2FL	3/4"
SL	—	SL8817-2FL	3/4"
Reflections*	—	8817-2RL	3/4"

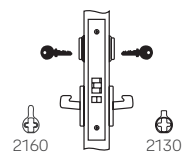

8814 Deadlock (F18)

- Deadbolt operated by key outside only
 - No inside operation
 - NOT UL listed
- Note: Indicators available for sectional trim only

Model Number	Deadbolt Throw
8814	1"

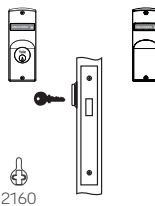

8818-2 Classroom Security Intruder Lock

- Latchbolt retracted by knob/lever unless outside knob/lever is locked by key
 - Deadbolt operated by key either side
 - When deadbolt is projected, outside knob/lever is automatically locked
 - Key retraction of latchbolt by either side unlocks outside knob/lever
 - Anti-panic operation. Operating inside knob/lever retracts the latchbolt and deadbolt simultaneously, **with outside knob/lever remaining locked.**
 - Deadlocking latchbolt
- Note: Indicator shows deadbolt position only

Trim	Model Numbers		Throw	
	Knobs	Levers	Latchbolt	Deadbolt
Standard	8818-2K	8818-2FL	3/4"	1"
SL	—	SL8818-2FL	3/4"	1"
Reflections*	—	8818-2RL	3/4"	1"

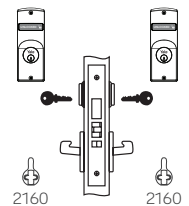

Indicator options available for both sectional and escutcheon trim.

Cylinder cam required.
 Indicates rigid knob/lever.

Mechanical Functions



8820 Hotel Guest Lock (F15)

- Latchbolt retracted by key outside, knob/lever inside
- Latchbolt retracted by master keys and change keys only when deadbolt is NOT projected
- Deadbolt operated by emergency/shut-out or display key outside and thumbturn inside
- When deadbolt is projected, the indicator shows red with a locked padlock icon (indicating room is occupied). Access from outside can be gained only with an emergency/shut-out or display key.
- Outside knob/lever rigid at all times
- Anti-panic operation. Operating inside knob/lever retracts the latchbolt and deadbolt simultaneously
- Deadlocking latchbolt
- **Master key system must be 7-pin**

Note: CIND indicator provided standard. V series indicators must be specified by option code. Indicator shows deadbolt position only.



Trim	Model Numbers		Latchbolt Throw
	Knobs	Levers	
Standard	8820K	8820FL	3/4"
SL	—	SL8820FL	3/4"
Reflections*	—	8820RL	3/4"

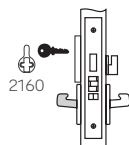

8827 Hotel/Motel Lock

- Latchbolt retracted by knob/lever either side, except when outside knob/lever is independently locked by stopwork activator or automatically locked when the deadbolt is projected
- Latchbolt retracted by master keys and change keys only when deadbolt is NOT projected
- Deadbolt operated by emergency/shut-out or display key outside and thumbturn inside
- When deadbolt is projected, the indicator shows red with a locked padlock icon (indicating room is occupied). Access from outside can be gained only with an emergency/shut-out or display key.
- Anti-panic operation. Operating inside knob/lever automatically retracts latchbolt and deadbolt with outside knob/lever remaining locked.
- Deadlocking latchbolt
- **Master key system must be 7-pin**

Function only available with CO, R6, R7, R8 roses or CN escutcheon
Note: CIND indicator provided standard. V series indicators must be specified by option code. Indicator shows deadbolt position only.



Trim	Model Numbers		Throw	
	Knobs	Levers	Latchbolt	Deadbolt
Standard	8827K	8827FL	3/4"	1"
SL	—	SL8827FL	3/4"	1"
Reflections*	—	8827RL	3/4"	1"

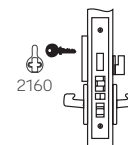

8822 Dormitory Or Exit Lock (F13)

- Latchbolt retracted by knob/lever either side
- Deadbolt operated by key outside and thumbturn inside
- When the deadbolt is projected, outside knob/lever is automatically locked
- Anti-panic operation. Operating inside knob/lever retracts the latchbolt and deadbolt simultaneously, automatically unlocking outside knob/lever.



Trim	Model Numbers		Throw	
	Knobs	Levers	Latchbolt	Deadbolt
Standard	8822K	8822FL	3/4"	1"
SL	—	SL8822FL	3/4"	1"
Reflections*	—	8822RL	3/4"	1"

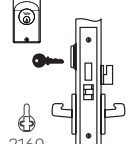

8828 Exit Or Communicating Lock (F31)

- For twin communicating or exit doors where one-sided operation is required
- Latchbolt retracted by knob/lever inside at all times
- No outside operations
- Deadlocking latchbolt

Trim	Model Numbers		Latchbolt Throw
	Knobs	Levers	
Standard	8828K	8828FL	3/4"
SL	—	SL8828FL	3/4"
Reflections*	—	8828RL	3/4"

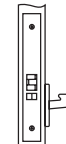

8823 Storeroom Lock

- Latchbolt retracted by knob/lever outside
- Deadbolt operated by key outside
- When deadbolt is projected, outside knob/lever is automatically locked
- No inside knob/lever or cylinder

Trim	Model Numbers		Throw	
	Knobs	Levers	Latchbolt	Deadbolt
Standard	8823K	8823FL	3/4"	1"
SL	—	SL8823FL	3/4"	1"
Reflections*	—	8823RL	3/4"	1"

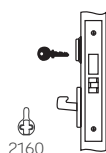

8829 Closet Lock

- Latchbolt retracted by knob/lever outside
- Outside cylinder locks or unlocks outside knob/lever
- No inside knob/lever or cylinder
- Deadlocking latchbolt

Trim	Model Numbers		Latchbolt Throw
	Knobs	Levers	
Standard	8829K	8829FL	3/4"
SL	—	SL8829FL	3/4"
Reflections*	—	8829RL	3/4"

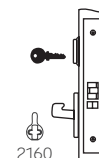

8824 Holdback Lock (F06)

- For classroom, office, or utility room doors
- Latchbolt retracted by knob/lever either side, except when outside knob/lever is locked by key outside
- Latchbolt can be held in retracted position by outside cylinder
- Inside knob/lever always active
- Deadlocking latchbolt
- NOT UL listed

Trim	Model Numbers		Latchbolt Throw
	Knobs	Levers	
Standard	8824K	8824FL	3/4"
SL	—	SL8824FL	3/4"
Reflections*	—	8824RL	3/4"

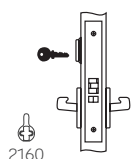

8830-2 Asylum Or Institutional Lock (F30)

- Latchbolt retracted by key both sides
- Rigid knob/lever both sides for use as pulls only
- Deadlocking latchbolt

Trim	Model Numbers		Latchbolt Throw
	Knobs	Levers	
Standard	8830-2K	8830-2FL	3/4"
SL	—	SL8830-2FL	3/4"
Reflections*	—	8830-2RL	3/4"

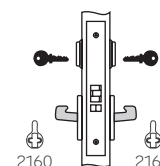

Indicator options available for both sectional and escutcheon trim.

Cylinder cam required.

Indicates rigid knob/lever.



Mechanical Functions

8831 Detention Lock

- Latchbolt retracted by key outside, knob/lever inside
- Latchbolt retracted by master keys and change keys only when deadbolt is NOT projected
- Deadbolt operated by emergency (guards) key only outside
- Inside knob/lever only opens door when deadbolt is in retracted position
- Outside knob/lever rigid at all times
- Deadlocking latchbolt
- Trim mounted with fasteners outside
- Furnished standard with TORX® security screws
- **Master key system must be 7-pin**

Trim	Model Numbers		Throw	
	Knobs	Levers	Latchbolt	Deadbolt
Standard	8831K	—	3/4"	1"
SL	—	SL8831FL	3/4"	1"

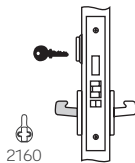

8834 All Purpose Lock

- Latchbolt retracted by key outside, knob/lever inside
- No knob/lever outside
- Latchbolt can be held in retracted position by inside thumbturn cylinder
- Deadlocking latchbolt
- NOT UL listed

Trim	Model Numbers		Latchbolt Throw
	Knobs	Levers	
Standard	8834K	8834FL	3/4"
Reflections*	—	8834RL	3/4"

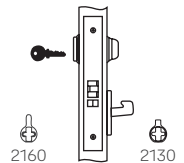

8832 Hotel/Motel Lock

- Latchbolt retracted by key outside, knob/lever inside
- Latchbolt retracted by master keys and change keys only when deadbolt is NOT projected
- Deadbolt operated by emergency/shut-out or display key only outside and thumbturn inside
- Outside knob/lever rigid at all times
- Anti-panic operation. Operating inside knob/lever retracts the latchbolt and deadbolt simultaneously.
- Deadlocking latchbolt
- **Master key system must be 7-pin**

Note: Indicator shows deadbolt position only

Trim	Model Numbers		Throw	
	Knobs	Levers	Latchbolt	Deadbolt
Standard	8832K	8832FL	3/4"	1"
SL	—	SL8832FL	3/4"	1"
Reflections*	—	8832RL	3/4"	1"

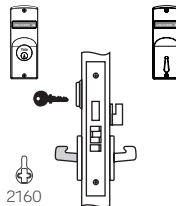

8834-2 All Purpose Lock

- For classroom, office, or utility room doors
- Latchbolt retracted by key outside, knob/lever inside
- No knob/lever outside
- Latchbolt can be held in retracted position by inside cylinder
- Deadlocking latchbolt
- NOT UL listed

Trim	Model Numbers		Latchbolt Throw
	Knobs	Levers	
Standard	8834-2K	8834-2FL	3/4"
Reflections*	—	8834-2RL	3/4"

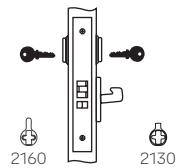

8833 Exit Lock

- Latchbolt retracted by key outside, knob/lever inside
- No knob/lever outside
- Deadlocking latchbolt

Trim	Model Numbers		Latchbolt Throw
	Knobs	Levers	
Standard	8833K	8833FL	3/4"
SL	—	SL8833FL	3/4"
Reflections*	—	8833RL	3/4"

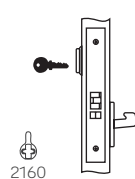

8835 Exit Lock

- Latchbolt retracted by knob/lever inside
- Deadbolt operated by thumbturn inside
- No outside operations
- Anti-panic operation. Operating inside knob/lever retracts the latchbolt and deadbolt simultaneously.
- Deadlocking latchbolt

Trim	Model Numbers		Throw	
	Knobs	Levers	Latchbolt	Deadbolt
Standard	8835K	8835FL	3/4"	1"
SL	—	SL8835FL	3/4"	1"
Reflections*	—	8835RL	3/4"	1"

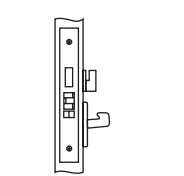

8833-2 All-Purpose Lock

- Latchbolt retracted by key both sides
- No knob/lever either side
- Deadlocking latchbolt

Model Number	Latchbolt Throw
8833-2	3/4"

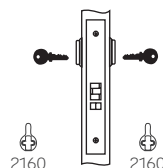

8840 Storeroom Deadbolt

- Latchbolt retracted by key outside, knob/lever inside
- Deadbolt operated by key outside and thumbturn inside
- Outside knob/lever rigid at all times
- Anti-panic operation. Operating inside knob/lever retracts the latchbolt and deadbolt simultaneously.
- Deadlocking latchbolt

Note: Indicator shows deadbolt position only

Trim	Model Numbers		Throw	
	Knobs	Levers	Latchbolt	Deadbolt
Standard	8840K	8840FL	3/4"	1"
SL	—	SL8840FL	3/4"	1"
Reflections*	—	8840RL	3/4"	1"

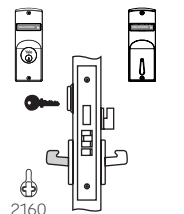

Indicator options available for both sectional and escutcheon trim.

Cylinder cam required.
 Indicates rigid knob/lever.



8847 Apartment Corridor Door Lock (F20)

- Latchbolt retracted by knob/lever either side, except when outside knob/lever is locked by stopwork activator
- Deadbolt operated by key outside, thumbturn inside
- When outside knob/lever is locked, latchbolt and deadbolt are operated by key outside
- When deadbolt is projected, outside knob/lever is automatically locked
- Anti-panic operation. Operating inside knob/lever automatically retracts latchbolt and deadbolt with outside knob/lever remaining locked.
- Deadlocking latchbolt

Note: Indicator shows deadbolt position only

Trim	Model Numbers		Throw	
	Knobs	Levers	Latchbolt	Deadbolt
Standard	8847K	8847FL	3/4"	1"
SL	—	SL8847FL	3/4"	1"
Reflections*	—	8847RL	3/4"	1"

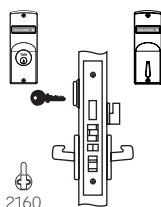

2160

8862 Privacy, Bedroom Or Bath Lock (F22)

- Latchbolt retracted by knob/lever either side except when outside knob/lever is locked by thumbturn
- Operating inside knob/lever retracts the latchbolt, automatically unlocking outside knob/lever
- Outside emergency release unlocks outside knob/lever. E203 emergency key supplied
- Automatically unlocks when door latches

Trim	Model Numbers		Latchbolt Throw
	Knobs	Levers	
Standard	8862K	8862FL	3/4"
SL	—	SL8862FL	3/4"
Reflections*	—	8862RL	3/4"

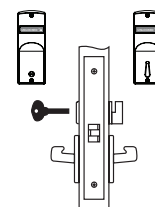

8860 Room Door Lock (F21)

- Latchbolt retracted by knob/lever either side
- Deadbolt operated by key outside, thumbturn inside

Trim	Model Numbers		Throw	
	Knobs	Levers	Latchbolt	Deadbolt
Standard	8860K	8860FL	3/4"	1"
SL	—	SL8860FL	3/4"	1"
Reflections*	—	8860RL	3/4"	1"

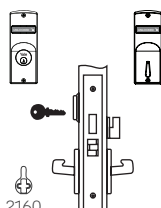

2160

8864 Bathroom Lock With Indicator

- Latchbolt retracted by key outside, knob/lever inside
 - Indicator operated by thumbturn inside, key outside
 - When indicator shows red with a locked padlock icon, key outside will operate indicator and retract latchbolt
 - Outside knob/lever rigid at all times
 - Inside knob/lever always active
 - Deadlocking latchbolt
 - Function only available with C0, R6, R7, R8 roses or CN escutcheon
- Note: CIND indicator provided standard. V series indicators must be specified by option code.

Trim	Model Numbers		Latchbolt Throw
	Knobs	Levers	
Standard	8864K	8864FL	3/4"
Reflections*	—	8864RL	3/4"

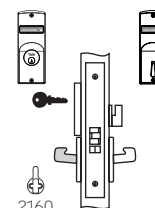

2160

8860-2 Store Door Lock (F14)

- Latchbolt retracted by knob/lever either side
- Deadbolt operated by key both sides

Trim	Model Numbers		Throw	
	Knobs	Levers	Latchbolt	Deadbolt
Standard	8860-2K	8860-2FL	3/4"	1"
SL	—	SL8860-2FL	3/4"	1"
Reflections*	—	8860-2RL	3/4"	1"

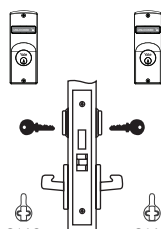

2160

2160

8865 Bathroom Lock

- Latchbolt retracted by knob/lever either side except when outside knob/lever is locked by thumbturn either side
- Outside thumbturn unlocks outside knob/lever
- Automatically unlocks when door latches
- Operating inside knob/lever retracts the latchbolt, automatically unlocking outside knob/lever

Trim	Model Numbers		Latchbolt Throw
	Knobs	Levers	
Standard	8865K	8865FL	3/4"
SL	—	SL8865FL	3/4"
Reflections*	—	8865RL	3/4"

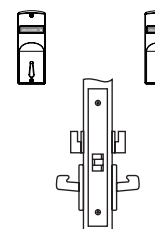

8861 Dormitory Or Storeroom Lock

- Latchbolt retracted by knob/lever either side
- Deadbolt operated by key outside, thumbturn inside
- When deadbolt is projected, outside knob/lever is automatically locked
- When deadbolt is retracted, outside knob/lever is automatically unlocked

Trim	Model Numbers		Throw	
	Knobs	Levers	Latchbolt	Deadbolt
Standard	8861K	8861FL	3/4"	1"
SL	—	SL8861FL	3/4"	1"
Reflections*	—	8861RL	3/4"	1"

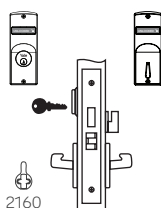

2160

8866 Passage Lock With Indicator

- For doors with indicator that do not require locking
 - Latchbolt retracted by knob/lever either side at all times
 - Throwing thumbturn on inside changes state of status indicator
 - Rotating either knob/lever returns indicator to previous state
- Note: Only available with "V" series indicators. Indicator option code must be specified with this function

Trim	Model Numbers		Latchbolt Throw
	Knobs	Levers	
Standard	8866K	8866FL	3/4"
Reflections*	—	8866RL	3/4"

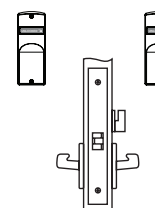

Indicator options available for both sectional and escutcheon trim.

Cylinder cam required.

Indicates rigid knob/lever.



Mechanical Functions

8867 Dormitory Or Exit Lock (F12)

- Latchbolt retracted by knob/lever either side, except when outside knob/lever is locked by stopwork activator or automatically locked when deadbolt is projected
- Deadbolt operated by key outside, thumbturn inside
- When outside knob/lever is locked, operating key outside retracts both latchbolt and deadbolt
- Anti-panic operation. Operating inside knob/lever retracts the latchbolt and deadbolt simultaneously, with outside knob/lever remaining locked.

Note: Indicator shows deadbolt position only

Trim	Model Numbers		Throw	
	Knobs	Levers	Latchbolt	Deadbolt
Standard	8867K	8867FL	3/4"	1"
SL	—	SL8867FL	3/4"	1"
Reflections*	—	8867RL	3/4"	1"

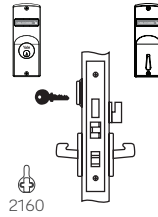

Active Dummy Trim

- Knob/lever both sides
 - Push or pull only
 - Primarily for lever handle trim
 - Knob/lever active to prevent damage
- 8871DT – Armor front acts as strike for latchbolt only functions
8872DT – Armor front acts as strike for latchbolt x deadbolt functions

Model Numbers			Outside Inside
Knobs	Levers	Reflections*	
8870DT	8870FLDT	8870RLDT	
8871DT	8871FLDT	8871RLDT	
8872DT	8872FLDT	8872RLDT	

Handing must be specified when ordering

836A/838A Dummy Trim Both Sides

- Push and pull only
- Knob/lever both sides
- Both knob/lever non-operational and rigid at all times
- Plain rectangular front used with spindle-bar stabilizer
- Available in all sectional and escutcheon trim

Model Numbers	
Knobs	Levers
836A prefixed by design symbol (i.e. COR836A, CO x CN836A)	838AFL prefixed by design symbol (i.e. JNR838AFL, JN x CN838AFL)

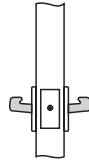

836B/838B Dummy Trim Both Sides

- Push or pull only
- Knob/lever both sides of inactive leaf of a pair of doors
- Both knob/lever non-operational and rigid at all times
- Available in all sectional and escutcheon trim
- 2815 Strike available upon request

Model Numbers	
Knobs	Levers
836B prefixed by design symbol (i.e. COR836B, CO x CN836B)	838BFL prefixed by design symbol (i.e. JNR838BFL, JN x CN838BFL)

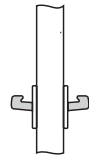

855 Dummy Trim One Side

- Push or pull only
- Knob/lever one side
- Knob/lever non-operational and rigid at all times
- Available in all sectional and escutcheon trim
- Rose trim available with CO, R3, R4, R5 roses only.

Model Numbers	
Knobs	Levers
855 prefixed by design symbol (i.e. COR855)	855FL prefixed by design symbol (i.e. CR x CN855FL)



Indicator options available for both sectional and escutcheon trim.



Cylinder cam required.



Indicates rigid knob/lever.

Indicators



Applications

8800 Series indicators can be used in a variety of applications and are most commonly used to identify occupancy or display the locked/unlocked status of a room.

- Restrooms
- Quiet rooms
- Nursing mother's rooms
- Classroom doors

Features

- Inside, outside or both sides of the door
- Sectional or escutcheon trim
- Available with 24 different functions – including thumbturn functions
- Viewing window 25% larger than competition
- Patented curved design for viewing at multiple angles
- Window located prominently above the cylinder
- Highly reflective viewing window for increased safety
- Optional directional engraving available – must specify handing
- Retrofittable for existing applications



Functions

• Indicators are available with the following 8800 Series functions. See pages 14-19 for details.

8802	8827
8808	8832
8808-2	8840
8809	8847
8811-2	8860
8812-2	8860-2
8814	8861
8814-2	8862
8815	8864
8818-2	8865
8820	8866
8822	8867



Indicators

Sectional Trim

- Surface mounted
- Torx security screws provided
- Compatible with all rose designs: CO, R3, R4, R5, R6, R7, R8
- Available with optional directional arrow engraving

To order indicator with complete lock, specify by adding V series indicator option code to order string. See page 23 for indicator codes and page 24 for how to order examples.



Retrofit/Upgrade Kits

Retrofit/upgrade kits only are available for existing applications only. Each kit includes single side indicator plate with mechanism, screw pack, plastic template and instructions.

To order retrofit/upgrade kits only, specify by model number below. Door thickness, handing and indicator option code must also be specified with kit. Retrofit/upgrade kits with directional engraving must include lock handing.

See page 24 for how to order examples. Note: Indicators for both sides of door require two kits.

	Model #	Used with Functions	Available Option Codes	Indicator Location
	YA190	8811-2, 8814, 8814-2, 8815, 8818-2, 8822, 8832, 8840, 8847, 8860, 8860-2, 8861, 8867	Outside Trim: V10, V20, V30, V40, V50, V60 Inside Trim: V01, V03, V04, V06	Inside and/or Outside*
	YA191	8812-2		
	YA192	8808, 8808-2, 8809		
	YA193	8802, 8820, 8827, 8862, 8864	V10, V20, V30, V40, V50, V60	Outside
	YA194	8802, 8820, 8822, 8827, 8832, 8840, 8847, 8860, 8861, 8867	V01, V03, V04, V06	Inside
	YA196	8862, 8864, 8865, 8866		
	YA198	8809		
	YA197	8866	Outside Trim: V10, V20, V30, V40, V50, V60 Inside Trim: V01, V03, V04, V06	Inside, Outside

*When indicators are required on both sides of the door, 2 upgrade kits must be ordered, one kit for each side.

Indicators



Escutcheon Trim

- Unique escutcheon (VN) for both inside and outside of door for indicator functions
- Non-indicator functions provide with standard escutcheons as ordered, i.e. E3, E4, CN, SL
- Through-bolted
- Torx security screws optional
- Available with optional directional arrow engraving

Specify option code when ordered with lock. See page 23 for indicator option codes and page 24 for how to order examples.

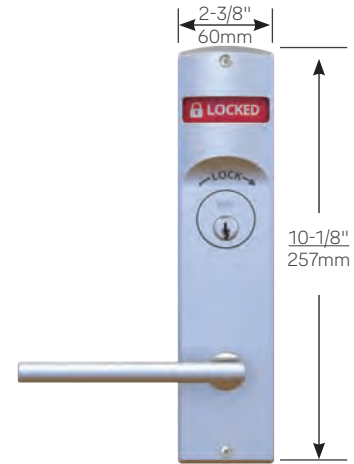

Escutcheon Trim Upgrade Kit Only

Complete trim kits are available to retrofit/upgrade existing applications.

Trim kit includes levers and escutcheons with mechanism for both sides of door, screw pack, door marker and instructions.

To order trim kit only, specify by adding TP prefix to function required with trim, hand, finish and indicator option code.

Prefix	Functions
TP	All functions*

*Escutcheon indicator trim kits available for all functions as listed on page 20 except 8814, 8814-2, 8815.

Note: Escutcheon applications require both sides of the door to have the unique VN escutcheon. Kits will be provided as a set.

How to Order Example (Escutcheon Kit Only)

Lever	Escutcheon	Function	Hand	Finish	Options
AU	VN	TP8802*	RH	626	V21 x EMB

* The function of the existing lock is required so the proper escutcheons can be provided.

Privacy Bedroom/Bath function x escutcheon trim x double indicator - Vacant/Occupied – Green/Red (Outside) Unlocked/Locked – Green/Red (Inside) x inside engraving with "Lock" and directional arrow



Indicator Option Codes

8800 Series indicator option codes are designed to convey wording, color and side of door desired in one simple code. To order, specify option code for complete locksets and/or retrofit/upgrade trim kits.

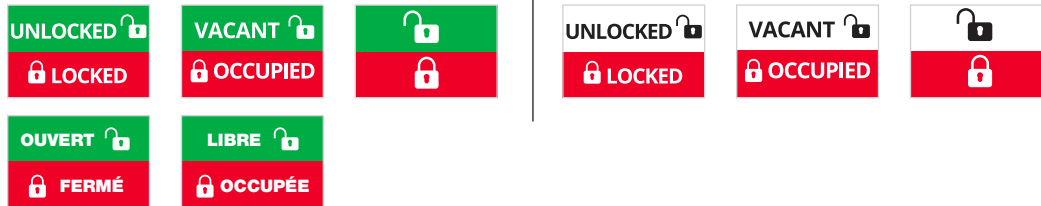

Single Indicator			
Option Code	Outside Wording	Inside Wording	Color
V10	Unlocked/Locked	No Indicator	Green/Red
V10F	Ouvert/Fermé	No Indicator	Green/Red
V20	Vacant/Occupied	No Indicator	Green/Red
V20F	Libre/Occupée	No Indicator	Green/Red
V30	Icons Only	No Indicator	Green/Red
V40	Unlocked/Locked	No Indicator	White/Red
V50	Vacant/Occupied	No Indicator	White/Red
V60	Icons Only	No Indicator	White/Red
V01	No Indicator	Unlocked/Locked	Green/Red
V01F	No Indicator	Ouvert/Fermé	Green/Red
V03	No Indicator	Icons Only	Green/Red
V04	No Indicator	Unlocked/Locked	White/Red
V06	No Indicator	Icons Only	White/Red
Double Indicator			
Option Code	Outside Wording	Inside Wording	Color
V11	Unlocked/Locked	Unlocked/Locked	Green/Red
V11F	Ouvert/Fermé	Ouvert/Fermé	Green/Red
V21	Vacant/Occupied	Unlocked/Locked	Green/Red
V21F	Libre/Occupée	Ouvert/Fermé	Green/Red
V33	Icons Only	Icons Only	Green/Red
V44	Unlocked/Locked	Unlocked/Locked	White/Red
V54	Vacant/Occupied	Unlocked/Locked	White/Red
V66	Icons Only	Icons Only	White/Red
Engraving			
Option Code	Outside	Inside	Wording
EMA	Engraving	No Engraving	"Lock" with arrow
EMB	No Engraving	Engraving	"Lock" with arrow
EMC	Engraving	Engraving	"Lock" with arrow



Engraving Options

- Laser engraving with "LOCK" and directional arrow
- Only available in the following finishes: 605, 606, 618, 619, 625, 626, 629*, 630*
- Available with MicroShield®
- Door handing must be specified

Option Code	Description
EMA	Engraving located on outside of door
EMB	Engraving located on inside of door
EMC	Engraving located on inside and outside of door

Note: Engraving is available as an option for all functions when ordered with an indicator. Option codes must be specified with complete lock and/or retrofit (upgrade) kits/trim.

*Indicator escutcheon is nickel plated to match Stainless Steel



How to Order Examples

Complete with Lock

Sectional Trim

Trim	Function	Hand	Finish	Options
AUR	8818-2FL	RH	626	V01

Classroom Security Intruder Latchbolt function x sectional trim x single indicator inside – Unlocked/Locked – Green/Red

Escutcheon Trim

Lever	Escutcheon	Function	Hand	Finish	Options
AU	VN	8802FL	RH	626	V21 x EMB

Privacy Bedroom/Bath function x escutcheon trim x double indicator - Vacant/Occupied – Green/Red (Outside) Unlocked/Locked – Green/Red (Inside) x inside engraving with "Lock" and directional arrow

Retrofit (Upgrade)/Trim Kit Only

Sectional Trim*

Model #	Door Thickness	Hand	Finish	Option
YA190	1-3/4"	RH	626	V04

Keyed function indicator for sectional trim x single indicator inside – Unlocked/Locked – Red/White

* When indicators are required on both sides of the door, 2 upgrade kits must be ordered, one kit for each side.

Escutcheon Trim

Lever	Escutcheon	Function	Hand	Finish	Options
AU	VN	TP8802**	RH	626	V21 x EMB

Privacy Bedroom/Bath function x escutcheon trim x double indicator - Vacant/Occupied – Green/Red (Outside) Unlocked/Locked – Green/Red (Inside) x inside engraving with "Lock" and directional arrow

** The function of the existing lock is required so the proper escutcheons can be provided.



Indicators - IND/CIND Option

Indicator options IND and CIND are provided with a padlock icon on a green or red background.

Trim Availability

	IND	CIND
Levers/Knobs	All	All
Roses	CO, R3, R4, R5, R6, R7, R8	CO, R6, R7, R8
Escutcheons	CN	CN



Functions

Indicators are available on the outside of the door for the following functions:

	8802	8818-2*	8820	8822	8827	8832	8862	8864
IND	Optional						Optional	
CIND		Optional	Standard	Optional	Standard	Optional		Standard

*Specify mounting side.

How To Order

When ordering with lock, specify the complete lock ordering string and include option code based on function.

Trim	Function	Hand	Finish	Option
AUR	8802FL	RH	626	IND
AUCN	8822FL	RH	626	CIND

When ordering for upgrade to existing lockset, specify kit number x finish.

Trim	Type	Kit
Sectional	Privacy	IND-K x Finish
Sectional	Cylinder	CIND-K x Finish
Escutcheon	Privacy	CN88 x 261 x Finish
Escutcheon	Cylinder	CN88 x 260 x Finish
Escutcheon	Cylinder w/cointurn	CN88 x 262 x Finish

Notes:

- IND-K and CIND-K are kits which includes indicator mechanism and mounting hardware. Cylinder not included.
- For escutcheon trim, CN88 is the outside escutcheon only with indicator assembly, does not include levers or cylinder

IND		CIND	
Deadbolt Thrown Locked icon/Red background	Deadbolt Retracted Unlocked icon/Green background	Deadbolt Thrown Locked icon/Red background	Deadbolt Retracted Unlocked icon/Green background

Electrified Mortise Locksets



Applications

Stair tower doors, office doors, classrooms, interlocks, elevator lobby doors, laboratories, computer rooms, cashier stations, hospital equipment rooms and pharmaceutical storage rooms. For narrow frame profiles, consult factory.

Trim Designs

8800 electrified mortise locksets are available with all knob, lever, SL and Reflections® trims.

ANSI/BHMA

Certified ANSI/BHMA A156.13, Series 1000, Operational Grade 1 (8800FL with CN escutcheon & SL8800 meet Security Grade 1).



Electrical Specifications

Fail Safe/Fail Secure
Voltage: 12VDC or 24VDC Regulated
Current Draw:
.25A at 24VDC
.5A at 12VDC
Operating Temp.:
Max. 151°F (66°C)
Min. -31°F (-35°C)

All monitoring switches rated at:
2 Amp @ 30 VDC
3 Amp @ 125 VAC

Monitoring Options

Model Number	Description
REX	Request to Exit - An SPDT switch that monitors activation of the free lever (not available with knob trim). REX is available for all mechanical and electrified functions and can be supplied alone or with either LBM or DBM.
LBM	Latchbolt Monitor - An SPDT switch that monitors full retraction of the latchbolt. LBM is available for all electrified functions and can be supplied alone or with REX.
DBM	Deadbolt Monitor - An SPDT switch that monitors full retraction of the deadbolt. DBM is available for all mechanical and electrified functions with a deadbolt and can be supplied alone or with REX.
ITS	Integrated Total Security - Enhanced security reporting allows facility supervisors to tailor decisions with greater certainty. Monitoring includes Request to Exit (REX), Lock Performance Monitoring (LPM), Concealed Door Position Status (DPS) and Cylinder Monitoring (CX). This monitoring option is available with 8890FL/8891FL or 8890RL/8891RL functions only. Locksets ordered with ITS option must be provided with Yale cylinder. Not available less cylinder. Handing must be specified.

ElectroLynx®

Yale® electrified 8800 locks are equipped with ElectroLynx connectors. As a standard feature, these connectors link power from the incoming source to electrified locking products, including hinges, locks, exit devices, magnetic holders and strikes.

Note: Electrified door hardware with ElectroLynx connectors require a compatible number of lead wires attached to the door hinge.





Electrified Mortise Lockset Functions

Fail Safe

The following functions are locked when power is on and unlocked when power is off.

8880

- Power off – outside lever active
- Power on – outside lever locked
- Auxiliary latch deadlocks latchbolt
- Inside lever always free
- No key override

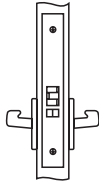

8896

- Power off – outside lever active (even when deadbolt thrown)
- Power on – outside lever locked
- Auxiliary latch deadlocks latchbolt
- Deadbolt projected by key outside, thumbturn inside
- Inside lever always free
- Mechanical key override by outside when locked

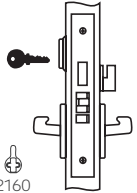

8884

- Power off – both levers active
- Power on – both levers locked
- Auxiliary latch deadlocks latchbolt
- No key override

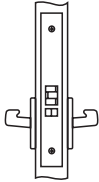

8896-2

- Power off – outside lever active (even when deadbolt thrown)
- Power on – outside lever locked
- Auxiliary latch deadlocks latchbolt
- Deadbolt projected by key both sides
- Inside lever always free
- Mechanical key override by both sides when locked

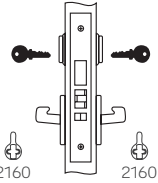

8890

- Power off – outside lever active
- Power on – outside lever locked
- Auxiliary latch deadlocks latchbolt
- Inside lever always free
- Mechanical key override by outside when locked

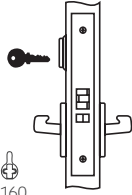

8898

- Power off – both levers active (even when deadbolt thrown)
- Power on – both levers locked
- Auxiliary latch deadlocks latchbolt
- Deadbolt projected by key outside, thumbturn inside
- Mechanical key override by outside when locked

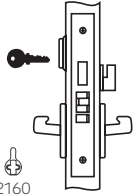

8894-2

- Power off – both levers active
- Power on – both levers locked
- Auxiliary latch deadlocks latchbolt
- Mechanical key override by both sides when locked

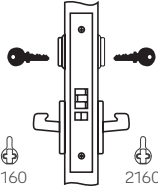

8898-2

- Power off – both levers active (even when deadbolt thrown)
- Power on – both levers locked
- Auxiliary latch deadlocks latchbolt
- Deadbolt projected by key both sides
- Mechanical key override by both sides when locked

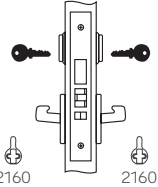

Electrified Mortise Lockset Functions



Fail Secure

The following functions are unlocked when the power is on and locked when power is off.

8881

- Power off – outside lever locked
- Power on – outside lever active
- Auxiliary latch deadlocks latchbolt
- Inside lever always free
- No key override

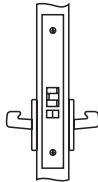

8897

- Power off – outside lever locked
- Power on – outside lever active (even when deadbolt thrown)
- Auxiliary latch deadlocks latchbolt
- Deadbolt projected by key outside, thumbturn inside
- Inside lever always free
- Mechanical key override by outside when locked

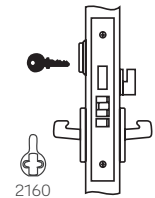

8885

- Power off – both levers locked
- Power on – both levers active
- Auxiliary latch deadlocks latchbolt
- No key override

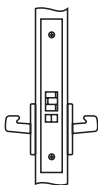

8897-2

- Power off – outside lever locked
- Power on – outside lever active (even when deadbolt thrown)
- Auxiliary latch deadlocks latchbolt
- Deadbolt projected by key both sides
- Inside lever always free
- Mechanical key override by both sides when locked

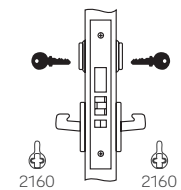

8891

- Power off – outside lever locked
- Power on – outside lever active
- Auxiliary latch deadlocks latchbolt
- Inside lever always free
- Mechanical key override by outside when locked

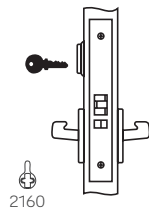

8899

- Power off – both levers locked
- Power on – both levers active (even when deadbolt thrown)
- Auxiliary latch deadlocks latchbolt
- Deadbolt projected by key outside, thumbturn inside
- Mechanical key override by outside when locked

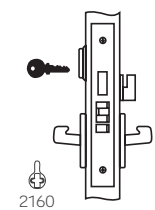

8895-2

- Power off – both levers locked
- Power on – both levers active
- Auxiliary latch deadlocks latchbolt
- Mechanical key override by both sides when locked

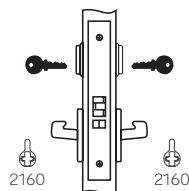

8899-2

- Power off – both levers locked
- Power on – both levers active (even when deadbolt thrown)
- Auxiliary latch deadlocks latchbolt
- Deadbolt projected by key both sides
- Mechanical key override by both sides when locked

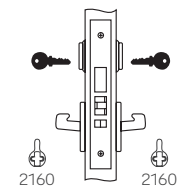



Electrified Mortise Lockset Accessories

BPS Power Supplies By Securitron®

Operation

Power supplies are designed to provide reliable filtered and regulated power for long life to a variety of electrified hardware components.

Product Features

- Individual output circuit breakers
- Regulated and filtered fuse protected outputs
- LEDs monitor zone status (voltage or no voltage)
- Slide switches connect or disconnect load from power (Not available on 1 Amp supplies)
- Internal Back-Up battery charging circuit
- Rugged steel enclosure
- Fire alarm interface

Listings

- UL CLASS 2

Applications (use with):

- Fail Safe mortise locks
- Fail Secure mortise locks

Ordering

Ex: BPS-24-4, BPS-12-3

Model	Input	Output	Application*
BPS-24-1	120 VAC	1 Amp @ 24 VDC	2-8800
BPS-24-2	120 VAC	2 Amp @ 24 VDC	5-8800
BPS-24-4	120 VAC	4 Amp @ 24 VDC	11-8800
BPS-12-1	120 VAC	1 Amp @ 12 VDC	1-8800
BPS-12-3	120 VAC	3 Amp @ 12 VDC	3-8800

*Preceding number denotes how many locks can be hardwired to each power supply.

Consult factory for additional power supply applications.

Yale recommends McKinney®, Pemko and Securitron® for power transfer devices and other electronic accessories.



Conventional Mortise Cylinders

Illustration	Cylinder Model Number	Application	Cam	Length	
				6-Pin	7-Pin
	2153	Standard cylinder	2160	1-1/8" 1-1/4" 1-3/8" 1-1/2" 1-5/8" 1-3/4"	1-1/4" 1-3/8" 1-1/2" 1-5/8" 1-3/4"
	2153S	For inside operation of 8817-2 and 8834-2 functions only	2130		
	2123	Cylinder for longer lengths	2160	1-7/8" thru 3-1/2" in 1/8" increments*	
	2123S	For inside operation of 8817-2 and 8834-2 functions only for longer lengths	2130		
	2719	For 8820, 8827, 8831 and 8832 functions	2160	1-3/8"	—

*Contact Technical Product Support for cylinder collar requirements when ordering these cylinders separately. See pages 33-40 for other collar requirements.

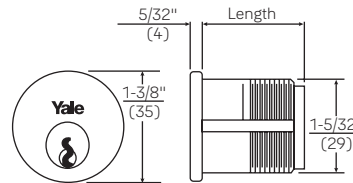

Interchangeable Core Mortise Cylinders

Cylinder Model Number	Application	Cam	Length	Pins	Housing Only Model Number	Core Only Model Number
2196	Standard Cylinder	2160	1-1/2", 1-3/4", 2"	6	2221	1210
2197	Standard Cylinder	2160	1-11/16", 2"	7	2213	1220
2196H	For Hotel/Motel Locks 8820, 8827, 8832	2160	1-11/16"	6	2213	1210H
2196S	For inside operations of 8817-2 and 8834-2 functions	2130	1-1/2"	6	2214S	1210
2197S	For inside operations of 8817-2 and 8834-2 functions	2130	1-11/16"	7	2217S	1220

Note: When ordering interchangeable core cylinders or cores only, control keys are not furnished. If control keys are required they must be ordered separately.

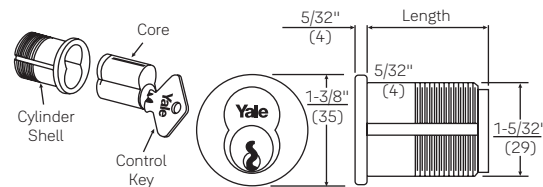

Security Cylinders

Security cylinders contain two independent locking mechanisms. The first is a traditional 6- or 7-pin tumbler mechanism with spool drivers for greatly increased picking resistance.

The second is an innovative 5-tumbler rotating disc mechanism with sidebar engagement. The rotating discs are spring loaded and block the bottom of the keyway.

Illustration

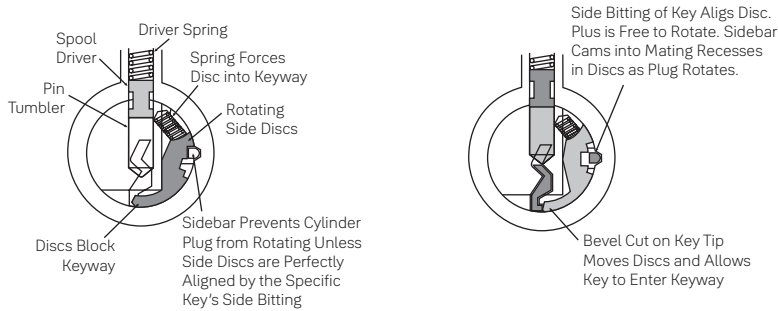

Security/High Security Mortise Cylinders

Model Number	Application	Cam	Length	
			6-pin	7-pin
5153/U5153	Standard Cylinder	2160	1-1/8"	1-1/4"
5153S/U5153S	For inside operations of 8817-2 and 8834-2 functions	2130	1-1/4"	
5719/U5719	For 8820, 8827, 8831 and 8832 functions	2160	1-3/8"	

Security Interchangeable Core Mortise Cylinders

Cylinder Model Number	Application	Cam	Length	Pins	Housing Only Model Number	Core Only Model Number
5196	Standard Cylinder	2160	1-1/2"	6	2221	5210
5197	Standard Cylinder	2160	1-11/16"	7	2213	5220
5196H	For Hotel/Motel Locks 8820, 8827, 8832	2160	1-11/16"	6	2213	5210H
5196S	For inside operations of 8817-2 and 8834-2 functions	2130	1-1/2"	6	2214S	5210
5197S	For inside operations of 8817-2 and 8834-2 functions	2130	1-11/16"	7	2217S	5220

Note: When ordering interchangeable core cylinders or cores only, control keys are not furnished. If control keys are required they must be ordered separately.



Yale® KeyMark®

For those applications requiring protected key control, Yale® KeyMark® cylinders guard against unauthorized key duplication. The Yale KeyMark Security Leg® keyway feature increases resistance against picking and impressioning and can easily retrofit into existing systems. For further details and availability, refer to the separate Yale KeyMark catalog.

Protected Keyway Mortise Cylinders

Model Number	Type	Cam	Length	Pins	Housing Only Model Number	Core Only Model Number
K100	Fixed Core Mortise	KC1	1-1/8", 1-1/4" 1-1/2", 1-3/4" 2"	6 or 7	N/A	N/A
K820	Large Format IC Mortise	KC1	1-1/2", 1-3/4" 2"	6	K860	K800
			1-11/16" 2"	7		
K620	Small Format IC Mortise	KC1	1-1/4"	6	K660	K600
			1-3/8", 1-3/4"	6 or 7		
K630	Small Format IC Mortise-Tapered	KC1	1-1/4"	6	K670	K600
			1-3/8"	6 or 7		

Note: KC2 cam required for inside operation of 8817-2 and 8834-2 functions.

Miscellaneous Cylinder

Cams

Model Number	Application	Cam	Length
S2053S	Thumbturn cylinder, for inside operation of 8834 function only	2130	1" 1-1/8"
S2053	Thumbturn cylinder, for replacement of key operated cylinder.	2160	1" 1-1/8"

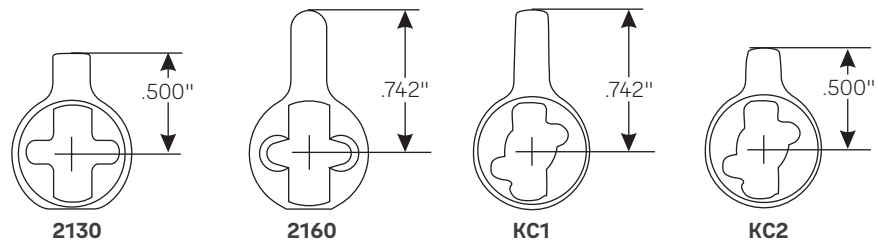

Other Manufacturers' Keyway Cylinders/Cores

Illustration	Model Number	Type	Cam	Length	Pins	Housing Only Model Number	Core Only Model Number
	A620	Small Format IC Mortise, includes Best® Keyway Core. Available keyed random, master keyed or uncombined. Specify keyway A, B, C, D, E, F, G, H, J, K, L or M.	KC1	1-1/4" 1-3/8" 1-3/4"	6 6 or 7	K660	A600
	2553	Fixed Core Mortise Schlage® "C" Keyway Cylinder. Available 0-bitted or keyed random. Available finishes: 606, 612, 613, 626	2160	1-1/8"	6	N/A	N/A



Cylinder Collars

Cylinder collars are supplied as standard where required with products supplied with cylinders. Collar size and thickness are supplied to suit the length of the cylinder, the thickness of the door and the trim ordered. (If door thickness is not specified, collars will be supplied to suit 1-3/4" (44mm) door.)

Collar length required must be specified for cylinders and/or housings ordered separately.

1765 Recessed Cylinder Collar

"A" Dimension: See chart for available sizes. To order, specify "1765.size" i.e. 1765.250.

Material: Brass, Stainless Steel

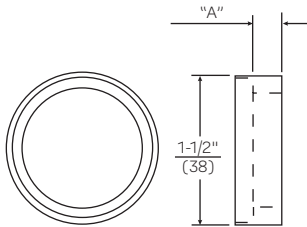

"A" Dimension					
Size	Specify	Size	Specify	Size	Specify
1/16"	.062	11/32"	.344	21/32"	.656
3/32"	.094	3/8"	.375	23/32"	.719
1/8"	.125	13/32"	.406	3/4"	.750
5/32"	.156	7/16"	.437	27/32"	.844
3/16"	.187	15/32"	.469	59/64"	.924
7/32"	.219	1/2"	.500	15/16"	.937
1/4"	.250	17/32"	.531	1-15/32"	1.473
9/32"	.281	9/16"	.563		
5/16"	.312	19/32"	.594		

1766 Step Collar for U5109 and U5153 High Security Cylinders.

Material: Stainless Steel

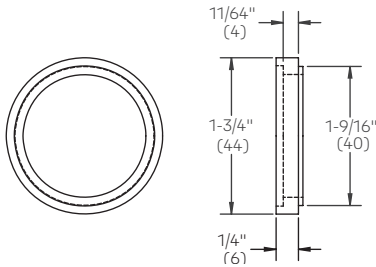

KP3 Wave Washer

(Furnished standard with 1765 collar for Yale® KeyMark® cylinders only).



KP4 Flush Mount Cylinder Collar

Material: Brass, Bronze

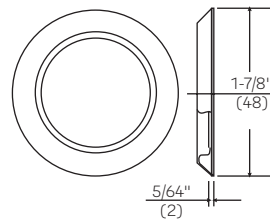

Cylinder Collars



For Use With Standard Sectional And All Reflections® Trims

Door Thickness	Rose or Escutcheon Trim Design	No. of Pins	2153, 2153S, 5153, 2123, 2123S Fixed Core Mortise Cylinders		U5153, U5153S, H.S. Fixed Core Cylinders		2196, 2196S, 5196, 2197, 2197S, 5197 LFIC Cylinders		5719, 2719 Fixed Core Hotel/Motel Cylinders	
			Cylinder Length	Collar Required	Cylinder Length	Collar Required	Cylinder Length	Collar Required	Cylinder Length	Collar Required
1-3/4" (44)	CO, R1, R2, R3, R4, R5, R6, R7, R8, E1, E2, E3, E4	6	1-1/8"	1765.250	1-1/8"	No Collar	1-1/2"	1765.656	1-3/8"	1765.531
		6 or 7	1-1/4"	1765.375	1-1/4"	1766	1-11/16"	1765.844		
		6 or 7	1-3/8"	1765.531	1-3/8"	N/A				
		6 or 7	1-1/2"	1765.656	1-1/2"	N/A				
2" (51)	CO, R1, R2, R3, R4, R5, R6, R7, R8, E1, E2, E3, E4	6	1-1/8"	1765.125	1-1/8"	N/A	1-1/2"	1765.531	1-3/8"	1765.531
		6 or 7	1-1/4"	1765.250	1-1/4"	No Collar	1-11/16"	1765.719		
		6 or 7	1-3/8"	1765.375	1-3/8"	N/A				
		6 or 7	1-1/2"	1765.531	1-1/2"	N/A				
2-1/4" (57)	CO, R1, R2, R3, R4, R5, R6, R7, R8, E1, E2, E3, E4	6	1-1/8"	KP4	1-1/8"	No Collar	1-1/2"	1765.375	1-3/8"	1765.250
		6 or 7	1-1/4"	1765.125	1-1/4"	No Collar	1-11/16"	1765.563		
		6 or 7	1-3/8"	1765.250	1-3/8"	N/A				
		6 or 7	1-1/2"	1765.375	1-1/2"	N/A				
2-1/2" (64)	CO, R1, R2, R3, R4, R5, R6, R7, R8, E1, E2, E3, E4	6	1-1/8"	N/A	1-1/8"	N/A	1-1/2"	1765.250	1-3/8"	1765.125
		6 or 7	1-1/4"	KP4	1-1/4"	No Collar	1-11/16"	1765.469		
		6 or 7	1-3/8"	1765.125	1-3/8"	N/A				
		6 or 7	1-1/2"	1765.250	1-1/2"	N/A				
2-3/4" (70)	CO, R1, R2, R3, R4, R5, R6, R7, R8, E1, E2, E3, E4	6	1-1/8"	N/A	1-1/8"	N/A	1-1/2"	1765.125	1-3/8"	KP4
		6 or 7	1-1/4"	N/A	1-1/4"	N/A	1-11/16"	1765.344		
		6 or 7	1-3/8"	KP4	1-3/8"	N/A				
		6 or 7	1-1/2"	1765.125	1-1/2"	N/A				
3" (76)	CO, R1, R2, R3, R4, R5, R6, R7, R8, E1, E2, E3, E4	6	1-1/8"	N/A	1-1/8"	N/A	1-1/2"	KP4	1-3/8"	N/A
		6 or 7	1-1/4"	N/A	1-1/4"	N/A	1-11/16"	1765.187		
		6 or 7	1-3/8"	N/A	1-3/8"	N/A				
		6 or 7	1-1/2"	KP4	1-1/2"	N/A				
3-1/4" (83)	CO, R1, R2, R3, R4, R5, R6, R7, R8, E1, E2, E3, E4	6	1-1/8"	N/A	1-1/8"	N/A	1-1/2"	N/A	1-3/8"	N/A
		6 or 7	1-1/4"	N/A	1-1/4"	N/A	1-11/16"	1765.062		
		6 or 7	1-3/8"	N/A	1-3/8"	N/A				
		6 or 7	1-1/2"	N/A	1-1/2"	N/A				

N/A = Application Not Available

Note: R1, R2, E1 and E2 discontinued. Information for reference only.

Cylinder Collars



For Use With Standard Sectional And All Reflections® Trims

Door Thickness	Rose or Escutcheon Trim Design	No. of Pins	5196H, 2196H Hotel/Motel LFIC Cylinders		K100 Yale® KeyMark® Fixed Core Cylinders		K820, K860 Yale® KeyMark® LFIC Cylinders		K620, K630 K660, K670, A620, A630 Yale® KeyMark® and Best® Keyway SFIC Cylinders	
			Cylinder Length	Collar Required	Cylinder Length	Collar Required	Cylinder Length	Collar Required	Cylinder Length	Collar Required
1-3/4" (44)	CO, R1, R2, R3, R4, R5, R6, R7, R8, E1, E2, E3, E4	6	1-11/16"	1765.844	1-1/8"	1765.312	1-1/2"	1765.656	1-1/4"	1765.375
		6 or 7			1-1/4"	1765.375	1-11/16"	1765.844	1-3/8"	1765.563
		6 or 7			1-1/2"	1765.656				
		6 or 7								
2" (51)	CO, R1, R2, R3, R4, R5, R6, R7, R8, E1, E2, E3, E4	6	1-11/16"	1765.719	1-1/8"	1765.187	1-1/2"	1765.563	1-1/4"	1765.281
		6 or 7			1-1/4"	1765.281	1-11/16"	1765.750	1-3/8"	1765.469
		6 or 7			1-1/2"	1765.563				
		6 or 7								
2-1/4" (57)	CO, R1, R2, R3, R4, R5, R6, R7, R8, E1, E2, E3, E4	6	1-11/16"	1765.563	1-1/8"	1765.062	1-1/2"	1765.406	1-1/4"	1765.125
		6 or 7			1-1/4"	1765.125	1-11/16"	1765.594	1-3/8"	1765.312
		6 or 7			1-1/2"	1765.406				
		6 or 7								
2-1/2" (64)	CO, R1, R2, R3, R4, R5, R6, R7, R8, E1, E2, E3, E4	6	1-11/16"	1765.469	1-1/8"	N/A	1-1/2"	1765.281	1-1/4"	1765.062
		6 or 7			1-1/4"	1765.062	1-11/16"	1765.500	1-3/8"	1765.187
		6 or 7			1-1/2"	1765.281				
		6 or 7								
2-3/4" (70)	CO, R1, R2, R3, R4, R5, R6, R7, R8, E1, E2, E3, E4	6	1-11/16"	1765.344	1-1/8"	N/A	1-1/2"	1765.187	1-1/4"	N/A
		6 or 7			1-1/4"	N/A	1-11/16"	1765.375	1-3/8"	1765.062
		6 or 7			1-1/2"	1765.187				
		6 or 7								
3" (76)	CO, R1, R2, R3, R4, R5, R6, R7, R8, E1, E2, E3, E4	6	1-11/16"	1765.187	1-1/8"	N/A	1-1/2"	1765.062	1-1/4"	N/A
		6 or 7			1-1/4"	N/A	1-11/16"	1765.219	1-3/8"	N/A
		6 or 7			1-1/2"	1765.062				
		6 or 7								
3-1/4" (83)	CO, R1, R2, R3, R4, R5, R6, R7, R8, E1, E2, E3, E4	6	1-11/16"	1765.062	1-1/8"	N/A	1-1/2"	N/A	1-1/4"	N/A
		6 or 7			1-1/4"	N/A	1-11/16"	1765.062	1-3/8"	N/A
		6 or 7			1-1/2"	N/A				
		6 or 7								

N/A = Application Not Available

Note: R1, R2, E1 and E2 discontinued. Information for reference only.

Cylinder Collars



For Use With Standard Escutcheon Trim

Door Thickness	Escutcheon Trim Design	No. of Pins	2153, 2153S, 5153, 2123, 2123S Fixed Core Mortise Cylinders		US153, US153S, H.S. Fixed Core Cylinders		2196, 2196S, 5196, 2197, 2197S, 5197 LFIC Cylinders		5719, 2719 Fixed Core Hotel/Motel Cylinders		5196H, 2196H Hotel/Motel LFIC Cylinders		K100 Yale® KeyMark® Fixed Core Cylinders		K820, K860 Yale® KeyMark® LFIC Cylinders		K620, K630 K660, K670, A620, A630 Yale® KeyMark® and Best® Keyway SFIC Cylinders	
			Cylinder Length	Collar Required	Cylinder Length	Collar Required	Cylinder Length	Collar Required	Cylinder Length	Collar Required	Cylinder Length	Collar Required	Cylinder Length	Collar Required	Cylinder Length	Collar Required	Cylinder Length	Collar Required
1-3/4" (44)	Copenhagen (R)	6	1-1/8"	1765.156	1-1/8"	No Collar	1-1/2"	1765.563	1-3/8"	1765.469	1-11/16"	1765.750	1-1/8"	1765.187	1-1/2"	1765.594	1-1/4"	1765.344
		6 or 7	1-1/4"	1765.312	1-3/8"	No Collar	1-11/16"	1765.750					1-1/4"	1765.344	1-11/16"	1765.844	1-3/8"	1765.469
		6 or 7	1-3/8"	1765.469	1-1/2"	No Collar												
	Camden (CN)	6	1-1/8"	No Collar	1-1/8"	N/A	1-1/2"	1765.219	1-3/8"	1765.094	1-11/16"	1765.469	1-1/8"	No Collar	1-1/2"	1765.250	1-1/4"	No Collar
		6 or 7	1-1/4"	No Collar	1-1/4"	N/A	1-11/16"	1765.406					1-1/4"	No Collar	1-11/16"	1765.469	1-3/8"	1765.125
		6 or 7	1-3/8"	1765.094	1-3/8"	N/A												
	SL	6	1-1/8"	1765.094	1-1/8"	N/A	1-1/2"	1765.469	1-3/8"	1765.344	1-11/16"	1765.656	1-1/8"	1765.125	1-1/2"	1765.500	1-1/4"	1765.156
		6 or 7	1-1/4"	1765.219	1-1/4"	No Collar	1-11/16"	1765.656					1-1/4"	1765.156	1-11/16"	1765.719	1-3/8"	1765.375
		6 or 7	1-3/8"	1765.375	1-3/8"	N/A												
	Easton (CE)	6	1-1/8"	1765.062	1-1/8"	N/A	1-1/2"	1765.500	1-3/8"	1765.375	1-11/16"	1765.656	1-1/8"	1765.125	1-1/2"	1765.500	1-1/4"	1765.156
		6 or 7	1-1/4"	1765.219	1-1/4"	No Collar	1-11/16"	1765.656					1-1/4"	1765.156	1-11/16"	1765.719	1-3/8"	1765.375
		6 or 7	1-3/8"	1765.344	1-3/8"	N/A												
Lenoir (LN)	6	1-1/8"	1765.500	1-1/2"	N/A	1-1/2"	1765.500	1-3/8"	1765.406	1-11/16"	1765.750	1-1/8"	1765.187	1-1/2"	1765.563	1-1/4"	1765.281	
	6 or 7	1-1/4"	1765.094	1-1/4"	N/A	1-11/16"	1765.750					1-1/4"	1765.281	1-11/16"	1765.750	1-3/8"	1765.469	
	6 or 7	1-3/8"	1765.406	1-3/8"	N/A													
Copenhagen (R)	6	1-1/8"	1765.531	1-1/2"	N/A	1-1/2"	1765.531	1-3/8"	1765.406	1-11/16"	1765.656	1-1/8"	1765.187	1-1/2"	1765.563	1-1/4"	1765.219	
	6 or 7	1-1/4"	1765.187	1-1/4"	No Collar	1-11/16"	1765.594					1-1/4"	1765.219	1-11/16"	1765.656	1-3/8"	1765.344	
	6 or 7	1-3/8"	1765.312	1-3/8"	N/A													
Camden (CN)	6	1-1/8"	1765.406	1-1/2"	N/A	1-1/2"	1765.406	1-3/8"	N/A	1-11/16"	1765.250	1-1/8"	N/A	1-1/2"	1765.125	1-1/4"	No Collar	
	6 or 7	1-1/4"	No Collar	1-1/4"	No Collar	1-11/16"	1765.250					1-1/4"	No Collar	1-11/16"	1765.344	1-3/8"	No Collar*	
	6 or 7	1-3/8"	N/A	1-3/8"	N/A													
SL	6	1-1/8"	1765.062	1-1/2"	N/A	1-1/2"	1765.344	1-3/8"	1765.219	1-11/16"	1765.531	1-1/8"	1765.094	1-1/2"	1765.375	1-1/4"	1765.250	
	6 or 7	1-1/4"	1765.094	1-1/4"	N/A	1-11/16"	1765.531					1-1/4"	1765.094	1-11/16"	1765.563	1-3/8"	1765.250	
	6 or 7	1-3/8"	1765.219	1-3/8"	N/A													
Easton (CE)	6	1-1/8"	N/A	1-1/8"	N/A	1-1/2"	1765.344	1-3/8"	1765.219	1-11/16"	1765.500	1-1/8"	1765.094	1-1/2"	1765.375	1-1/4"	1765.125	
	6 or 7	1-1/4"	1765.062	1-1/4"	N/A	1-11/16"	1765.500					1-1/4"	1765.094	1-11/16"	1765.563	1-3/8"	1765.250	
	6 or 7	1-3/8"	1765.219	1-3/8"	N/A													
Lenoir (LN)	6	1-1/8"	1765.344	1-1/2"	N/A	1-1/2"	1765.344	1-3/8"	1765.187	1-11/16"	1765.531	1-1/8"	No Collar*	1-1/2"	1765.406	1-1/4"	1765.125	
	6 or 7	1-1/4"	No Collar	1-1/4"	N/A	1-11/16"	1765.531					1-1/4"	1765.125	1-11/16"	1765.594	1-3/8"	1765.312	
	6 or 7	1-3/8"	1765.187	1-3/8"	N/A													

*Single Cylinder Only
 N/A = Application Not Available
 Note: Copenhagen, Easton and Lenoir escutcheons discontinued. Information for reference only.

Cylinder Collars



For Use With Standard Escutcheon Trim

Door Thickness	Escutcheon Trim Design	No. of Pins	2153, 2153S, 5153, 2123, 2123S Fixed Core Mortise Cylinders		U5153, U5153S, H.S. Fixed Core Cylinders		2196, 2196S, 5196, 2197, 2197S, 5197 LFIC Cylinders		5719, 2719 Fixed Core Hotel/Motel Cylinders		5196H, 2196H Hotel/Motel LFIC Cylinders		K100 Yale® KeyMark® Fixed Core Cylinders		K820, K860 Yale® KeyMark® LFIC Cylinders		K620, K630, K660, K670, A620, A630 Yale® KeyMark® and Best® Keyway SFIC Cylinders				
			Cylinder Length	Collar Required	Cylinder Length	Collar Required	Cylinder Length	Collar Required	Cylinder Length	Collar Required	Cylinder Length	Collar Required	Cylinder Length	Collar Required	Cylinder Length	Collar Required	Cylinder Length	Collar Required	Cylinder Length	Collar Required	
2-1/4" (57)	Copenhagen (R)	6	1-1/8"	N/A	1-1/8"	N/A	1-1/2"	1765.344	1-3/8"	1765.187	1-11/16"	1765.500	1-1/8"	N/A	1-1/2"	1765.375	1-1/4"	1765.094	1-1/4"	1765.094	
		6 or 7	1-1/4"	1765.062	1-1/4"	N/A	1-11/16"	1765.500			1-11/16"		1-1/2"	N/A	1-11/16"	1765.531	1-3/8"	1765.250	1-3/8"	1765.250	
		6 or 7	1-3/8"	1765.187	1-3/8"	N/A															
		6 or 7	1-1/2"	1765.344	1-1/2"	N/A															
	Camden (CN)	6	1-1/8"	N/A	1-1/8"	N/A	1-1/2"	N/A	1-3/8"	No Collar	1-11/16"	1765.156	1-1/8"	1765.156	1-1/2"	N/A	1-1/4"	N/A	1-1/4"	N/A	
		6 or 7	1-1/4"	N/A	1-1/4"	N/A	1-11/16"	1765.156					1-1/4"		1-11/16"	1765.219	1-3/8"	No Collar*	1-3/8"	No Collar*	
		6 or 7	1-3/8"	No Collar	1-3/8"	N/A															
		6 or 7	1-1/2"	N/A	1-1/2"	N/A															
	SL	6	1-1/8"	N/A	1-1/8"	N/A	1-1/2"	N/A	1-3/8"	1765.062	1-11/16"	1765.406	1-1/8"	1765.406	1-1/2"	N/A	1-1/4"	N/A	1-1/4"	N/A	
		6 or 7	1-1/4"	N/A	1-1/4"	N/A	1-11/16"	1765.406					1-1/4"		1-11/16"	1765.469	1-3/8"	1765.156	1-3/8"	1765.156	
		6 or 7	1-3/8"	1765.062	1-3/8"	N/A															
		6 or 7	1-1/2"	1765.219	1-1/2"	N/A															
Easton (CE)	6	1-1/8"	N/A	1-1/8"	N/A	1-1/2"	N/A	1-3/8"	1765.062	1-11/16"	1765.406	1-1/8"	1765.406	1-1/2"	N/A	1-1/4"	N/A	1-1/4"	N/A		
	6 or 7	1-1/4"	N/A	1-1/4"	N/A	1-11/16"	1765.406					1-1/4"		1-11/16"	1765.469	1-3/8"	1765.156	1-3/8"	1765.156		
	6 or 7	1-3/8"	1765.062	1-3/8"	N/A																
	6 or 7	1-1/2"	1765.219	1-1/2"	N/A																
Lenoir® (LN)	5	1-1/8"	N/A	1-1/8"	No Collar	1-1/2"	1765.219	1-3/8"	No Collar	1-11/16"	1765.406	1-1/8"	1765.406	1-1/2"	No Collar	1-1/4"	1765.062	1-1/4"	1765.062		
	6	1-1/4"	No Collar	1-1/4"	No Collar	1-11/16"	1765.406					1-1/4"		1-11/16"	1765.469	1-3/8"	1765.187	1-3/8"	1765.187		
	6 or 7	1-3/8"	1765.094	1-3/8"	No Collar																
	6 or 7	1-1/2"	1765.219	1-1/2"	No Collar																
Copenhagen (R)	6	1-1/8"	N/A	1-1/8"	N/A	1-1/2"	1765.187	1-3/8"	1765.062	1-11/16"	1765.375	1-1/8"	1765.375	1-1/2"	N/A	1-1/4"	1765.094	1-1/4"	1765.094		
	6 or 7	1-1/4"	N/A	1-1/4"	N/A	1-11/16"	1765.375					1-1/4"		1-11/16"	1765.406	1-3/8"	1765.094	1-3/8"	1765.094		
	6 or 7	1-3/8"	1765.062	1-3/8"	N/A																
	6 or 7	1-1/2"	1765.187	1-1/2"	N/A																
Camden (CN)	6	1-1/8"	N/A	1-1/8"	N/A	1-1/2"	No Collar	1-3/8"	N/A	1-11/16"	1765.062	1-1/8"	1765.062	1-1/2"	No Collar	1-1/4"	N/A	1-1/4"	N/A		
	6 or 7	1-1/4"	N/A	1-1/4"	N/A	1-11/16"	1765.062					1-1/4"		1-11/16"	1765.062	1-3/8"	N/A	1-3/8"	N/A		
	6 or 7	1-3/8"	N/A	1-3/8"	N/A																
	6 or 7	1-1/2"	No Collar	1-1/2"	N/A																
SL	6	1-1/8"	N/A	1-1/8"	N/A	1-1/2"	1765.062	1-3/8"	N/A	1-11/16"	1765.250	1-1/8"	1765.250	1-1/2"	N/A	1-1/4"	1765.094	1-1/4"	1765.094		
	6 or 7	1-1/4"	N/A	1-1/4"	N/A	1-11/16"	1765.250					1-1/4"		1-11/16"	1765.312	1-3/8"	1765.094	1-3/8"	1765.094		
	6 or 7	1-3/8"	N/A	1-3/8"	N/A																
	6 or 7	1-1/2"	No Collar	1-1/2"	N/A																
Easton (CE)	6	1-1/8"	N/A	1-1/8"	N/A	1-1/2"	1765.062	1-3/8"	N/A	1-11/16"	1765.250	1-1/8"	1765.250	1-1/2"	N/A	1-1/4"	1765.094	1-1/4"	1765.094		
	6 or 7	1-1/4"	N/A	1-1/4"	N/A	1-11/16"	1765.250					1-1/4"		1-11/16"	1765.312	1-3/8"	1765.094	1-3/8"	1765.094		
	6 or 7	1-3/8"	N/A	1-3/8"	N/A																
	6 or 7	1-1/2"	1765.062	1-1/2"	N/A																
Lenoir (LN)	6	1-1/8"	N/A	1-1/8"	N/A	1-1/2"	1765.094	1-3/8"	N/A	1-11/16"	1765.312	1-1/8"	1765.312	1-1/2"	No Collar	1-1/4"	No Collar	1-1/4"	No Collar		
	6 or 7	1-1/4"	N/A	1-1/4"	N/A	1-11/16"	1765.312					1-1/4"		1-11/16"	1765.375	1-3/8"	1765.062	1-3/8"	1765.062		
	6 or 7	1-3/8"	No Collar	1-3/8"	N/A																
	6 or 7	1-1/2"	1765.094	1-1/2"	N/A																

*Single Cylinder Only
 N/A = Application Not Available
Note: Copenhagen, Easton and Lenoir escutcheons discontinued. Information for reference only.

Cylinder Collars



For Use With Standard Escutcheon Trim

Door Thickness	Escutcheon Trim Design	No. of Pins	2153, 2153S, 5153, 2123, 2123S Fixed Core Mortise Cylinders		U5153, U5153S, H.S. Fixed Core Cylinders		2196, 2196S, 5196, 2197, 2197S, 5197 LFC Cylinders		5719, 2719 Fixed Core Hotel/Motel Cylinders		5196H, 2196H Hotel/Motel LFC Cylinders		K100 Yale® KeyMark® Fixed Core Cylinders		K820, K860 Yale® KeyMark® LFC Cylinders		K620, K630 K660, K670, A620, A630 Yale® KeyMark® and Best® Keyway SFIC Cylinders			
			Cylinder Length	Collar Required	Cylinder Length	Collar Required	Cylinder Length	Collar Required	Cylinder Length	Collar Required	Cylinder Length	Collar Required	Cylinder Length	Collar Required	Cylinder Length	Collar Required	Cylinder Length	Collar Required	Cylinder Length	Collar Required
2-3/4" (70)	Copenhagen (R)	6	1-1/8"	N/A	1-1/2"	1765.062	1-1/2"	1765.062	1-3/8"	N/A	1-11/16"	1765.250	1-1/2"	N/A	1-1/2"	1765.062	1-1/2"	1765.062	1-1/4"	N/A
		6 or 7	1-1/4"	N/A	1-11/16"	1765.250	1-3/8"	N/A	1-11/16"	No Collar	1-1/2"	1765.062	1-1/2"	N/A	1-1/2"	1765.062	1-1/2"	1765.062	1-3/8"	N/A
		6 or 7	1-3/8"	N/A	1-1/2"	N/A	1-1/2"	N/A	1-1/2"	N/A	1-3/8"	N/A	1-11/16"	No Collar	1-1/2"	N/A	1-1/2"	N/A	1-3/8"	N/A
		6 or 7	1-1/8"	N/A	1-1/2"	N/A	1-1/2"	N/A	1-1/2"	N/A	1-3/8"	N/A	1-11/16"	No Collar	1-1/2"	N/A	1-1/2"	N/A	1-3/8"	N/A
	Camden (CN)	6	1-1/8"	N/A	1-1/2"	N/A	1-1/2"	N/A	1-1/2"	N/A	1-3/8"	N/A	1-11/16"	No Collar	1-1/2"	N/A	1-1/2"	N/A	1-1/4"	N/A
		6 or 7	1-1/4"	N/A	1-11/16"	1765.094	1-1/2"	N/A	1-1/2"	N/A	1-3/8"	N/A	1-11/16"	No Collar	1-1/2"	N/A	1-1/2"	N/A	1-1/4"	N/A
		6 or 7	1-3/8"	N/A	1-1/2"	N/A	1-1/2"	N/A	1-1/2"	N/A	1-3/8"	N/A	1-11/16"	No Collar	1-1/2"	N/A	1-1/2"	N/A	1-3/8"	N/A
		6 or 7	1-1/2"	N/A	1-1/2"	N/A	1-1/2"	N/A	1-1/2"	N/A	1-3/8"	N/A	1-11/16"	No Collar	1-1/2"	N/A	1-1/2"	N/A	1-3/8"	N/A
	SL	6	1-1/8"	N/A	1-1/2"	N/A	1-1/2"	N/A	1-1/2"	N/A	1-3/8"	N/A	1-11/16"	1765.094	1-1/2"	N/A	1-1/2"	N/A	1-1/4"	N/A
		6 or 7	1-1/4"	N/A	1-11/16"	1765.094	1-1/2"	N/A	1-1/2"	N/A	1-3/8"	N/A	1-11/16"	1765.094	1-1/2"	N/A	1-1/2"	N/A	1-1/4"	N/A
		6 or 7	1-3/8"	N/A	1-1/2"	N/A	1-1/2"	N/A	1-1/2"	N/A	1-3/8"	N/A	1-11/16"	1765.094	1-1/2"	N/A	1-1/2"	N/A	1-1/4"	N/A
		6 or 7	1-1/2"	N/A	1-1/2"	N/A	1-1/2"	N/A	1-1/2"	N/A	1-3/8"	N/A	1-11/16"	1765.094	1-1/2"	N/A	1-1/2"	N/A	1-1/4"	N/A
Easton (CE)	6	1-1/8"	N/A	1-1/2"	N/A	1-1/2"	N/A	1-1/2"	N/A	1-3/8"	N/A	1-11/16"	1765.062	1-1/2"	N/A	1-1/2"	N/A	1-1/4"	N/A	
	6 or 7	1-1/4"	N/A	1-11/16"	1765.156	1-1/2"	N/A	1-1/2"	N/A	1-3/8"	N/A	1-11/16"	1765.156	1-1/2"	N/A	1-1/2"	N/A	1-1/4"	N/A	
	6 or 7	1-3/8"	N/A	1-1/2"	N/A	1-1/2"	N/A	1-1/2"	N/A	1-3/8"	N/A	1-11/16"	1765.156	1-1/2"	N/A	1-1/2"	N/A	1-1/4"	N/A	
	6 or 7	1-1/2"	N/A	1-1/2"	N/A	1-1/2"	N/A	1-1/2"	N/A	1-3/8"	N/A	1-11/16"	1765.156	1-1/2"	N/A	1-1/2"	N/A	1-1/4"	N/A	
Lenoir* (LN)	6	1-1/8"	N/A	1-1/2"	N/A	1-1/2"	N/A	1-1/2"	N/A	1-3/8"	N/A	1-11/16"	1765.062	1-1/2"	N/A	1-1/2"	N/A	1-1/4"	N/A	
	6 or 7	1-1/4"	N/A	1-11/16"	1765.094	1-1/2"	N/A	1-1/2"	N/A	1-3/8"	N/A	1-11/16"	1765.094	1-1/2"	N/A	1-1/2"	N/A	1-1/4"	N/A	
	6 or 7	1-3/8"	N/A	1-1/2"	N/A	1-1/2"	N/A	1-1/2"	N/A	1-3/8"	N/A	1-11/16"	1765.094	1-1/2"	N/A	1-1/2"	N/A	1-1/4"	N/A	
	6 or 7	1-1/2"	N/A	1-1/2"	N/A	1-1/2"	N/A	1-1/2"	N/A	1-3/8"	N/A	1-11/16"	1765.094	1-1/2"	N/A	1-1/2"	N/A	1-1/4"	N/A	
3" (76)	Copenhagen (R)	6	1-1/8"	N/A	1-1/2"	N/A	1-1/2"	N/A	1-1/2"	N/A	1-3/8"	N/A	1-11/16"	1765.062	1-1/2"	N/A	1-1/2"	N/A	1-1/4"	N/A
		6 or 7	1-1/4"	N/A	1-11/16"	1765.094	1-1/2"	N/A	1-1/2"	N/A	1-3/8"	N/A	1-11/16"	1765.094	1-1/2"	N/A	1-1/2"	N/A	1-1/4"	N/A
		6 or 7	1-3/8"	N/A	1-1/2"	N/A	1-1/2"	N/A	1-1/2"	N/A	1-3/8"	N/A	1-11/16"	1765.094	1-1/2"	N/A	1-1/2"	N/A	1-1/4"	N/A
		6 or 7	1-1/2"	N/A	1-1/2"	N/A	1-1/2"	N/A	1-1/2"	N/A	1-3/8"	N/A	1-11/16"	1765.094	1-1/2"	N/A	1-1/2"	N/A	1-1/4"	N/A
	Camden (CN)	6	1-1/8"	N/A	1-1/2"	N/A	1-1/2"	N/A	1-1/2"	N/A	1-3/8"	N/A	1-11/16"	N/A	1-1/2"	N/A	1-1/2"	N/A	1-1/4"	N/A
		6 or 7	1-1/4"	N/A	1-11/16"	N/A	1-1/2"	N/A	1-1/2"	N/A	1-3/8"	N/A	1-11/16"	N/A	1-1/2"	N/A	1-1/2"	N/A	1-1/4"	N/A
		6 or 7	1-3/8"	N/A	1-1/2"	N/A	1-1/2"	N/A	1-1/2"	N/A	1-3/8"	N/A	1-11/16"	N/A	1-1/2"	N/A	1-1/2"	N/A	1-1/4"	N/A
		6 or 7	1-1/2"	N/A	1-1/2"	N/A	1-1/2"	N/A	1-1/2"	N/A	1-3/8"	N/A	1-11/16"	N/A	1-1/2"	N/A	1-1/2"	N/A	1-1/4"	N/A
	SL	6	1-1/8"	N/A	1-1/2"	N/A	1-1/2"	N/A	1-1/2"	N/A	1-3/8"	N/A	1-11/16"	N/A	1-1/2"	N/A	1-1/2"	N/A	1-1/4"	N/A
		6 or 7	1-1/4"	N/A	1-11/16"	N/A	1-1/2"	N/A	1-1/2"	N/A	1-3/8"	N/A	1-11/16"	N/A	1-1/2"	N/A	1-1/2"	N/A	1-1/4"	N/A
		6 or 7	1-3/8"	N/A	1-1/2"	N/A	1-1/2"	N/A	1-1/2"	N/A	1-3/8"	N/A	1-11/16"	N/A	1-1/2"	N/A	1-1/2"	N/A	1-1/4"	N/A
		6 or 7	1-1/2"	N/A	1-1/2"	N/A	1-1/2"	N/A	1-1/2"	N/A	1-3/8"	N/A	1-11/16"	N/A	1-1/2"	N/A	1-1/2"	N/A	1-1/4"	N/A
Easton (CE)	6	1-1/8"	N/A	1-1/2"	N/A	1-1/2"	N/A	1-1/2"	N/A	1-3/8"	N/A	1-11/16"	N/A	1-1/2"	N/A	1-1/2"	N/A	1-1/4"	N/A	
	6 or 7	1-1/4"	N/A	1-11/16"	N/A	1-1/2"	N/A	1-1/2"	N/A	1-3/8"	N/A	1-11/16"	N/A	1-1/2"	N/A	1-1/2"	N/A	1-1/4"	N/A	
	6 or 7	1-3/8"	N/A	1-1/2"	N/A	1-1/2"	N/A	1-1/2"	N/A	1-3/8"	N/A	1-11/16"	N/A	1-1/2"	N/A	1-1/2"	N/A	1-1/4"	N/A	
	6 or 7	1-1/2"	N/A	1-1/2"	N/A	1-1/2"	N/A	1-1/2"	N/A	1-3/8"	N/A	1-11/16"	N/A	1-1/2"	N/A	1-1/2"	N/A	1-1/4"	N/A	
Lenoir (LN)	6	1-1/8"	N/A	1-1/2"	N/A	1-1/2"	N/A	1-1/2"	N/A	1-3/8"	N/A	1-11/16"	1765.062	1-1/2"	N/A	1-1/2"	N/A	1-1/4"	N/A	
	6 or 7	1-1/4"	N/A	1-11/16"	1765.062	1-1/2"	N/A	1-1/2"	N/A	1-3/8"	N/A	1-11/16"	1765.062	1-1/2"	N/A	1-1/2"	N/A	1-1/4"	N/A	
	6 or 7	1-3/8"	N/A	1-1/2"	N/A	1-1/2"	N/A	1-1/2"	N/A	1-3/8"	N/A	1-11/16"	1765.062	1-1/2"	N/A	1-1/2"	N/A	1-1/4"	N/A	
	6 or 7	1-1/2"	N/A	1-1/2"	N/A	1-1/2"	N/A	1-1/2"	N/A	1-3/8"	N/A	1-11/16"	1765.062	1-1/2"	N/A	1-1/2"	N/A	1-1/4"	N/A	

*Single Cylinder Only
 N/A = Application Not Available
 Note: Copenhagen, Easton and Lenoir escutcheons discontinued. Information for reference only.

Cylinder Collars



For Use With Standard Escutcheon Trim

Door Thickness	Escutcheon Trim Design	No. of Pins	2153, 2153S, 5153, 2123, 2123S Fixed Core Mortise Cylinders		U5153, U5153S, H.S. Fixed Core Cylinders		2196, 2196S, 5196, 2197, 2197S, 5197 LFIC Cylinders		5719, 2719 Fixed Core Hotel/Motel Cylinders		5196H, 2196H Hotel/Motel LFIC Cylinders		K100 Yale® KeyMark® Fixed Core Cylinders		K820, K860 Yale® KeyMark® LFIC Cylinders		K620, K630 K660, K670, A620, A630 Yale® KeyMark® and Best® Keyway SFIC Cylinders		
			Cylinder Length	Collar Required	Cylinder Length	Collar Required	Cylinder Length	Collar Required	Cylinder Length	Collar Required	Cylinder Length	Collar Required	Cylinder Length	Collar Required	Cylinder Length	Collar Required	Cylinder Length	Collar Required	
3-1/4" (83)	Copenhagen (R)	6	1-1/8"	N/A	1-1/8"	N/A	1-1/2"	N/A	1-3/8"	N/A	1-11/16"	1765.062	1-1/8"	**	1-1/2"	**	1-1/4"	**	
		6 or 7	1-1/4"	N/A	1-1/4"	N/A	1-11/16"	N/A	1-3/8"	N/A	1-11/16"	1765.062	1-1/4"	**	1-11/16"	**	1-3/8"	**	
		6 or 7	1-3/8"	N/A	1-3/8"	N/A													
		6 or 7	1-1/2"	N/A	1-1/2"	N/A													
		6 or 7	1-5/8"	N/A	1-5/8"	N/A													
		6 or 7	1-3/4"	1765.062	1-3/4"	N/A													
	Camden (CN)	6 or 7	1-7/8"	1765.125	1-7/8"	N/A													
		6 or 7	1-1/8"	N/A	1-1/8"	N/A	1-1/2"	N/A	1-3/8"	N/A	1-11/16"	1765.062	1-1/8"	**	1-1/2"	**	1-1/4"	**	
		6 or 7	1-1/4"	N/A	1-1/4"	N/A	1-11/16"	N/A	1-3/8"	N/A	1-11/16"	1765.062	1-1/4"	**	1-11/16"	**	1-3/8"	**	
		6 or 7	1-3/8"	N/A	1-3/8"	N/A													
		6 or 7	1-1/2"	N/A	1-1/2"	N/A													
		6 or 7	1-5/8"	N/A	1-5/8"	N/A													
	SL	6 or 7	1-3/4"	N/A	1-3/4"	N/A													
		6 or 7	1-7/8"	No Collar	1-7/8"	N/A													
		6	1-1/8"	N/A	1-1/8"	N/A	1-1/2"	N/A	1-3/8"	N/A	1-11/16"	1765.062	1-1/8"	**	1-1/2"	**	1-1/4"	**	
		6 or 7	1-1/4"	N/A	1-1/4"	N/A	1-11/16"	N/A	1-3/8"	N/A	1-11/16"	1765.062	1-1/4"	**	1-11/16"	**	1-3/8"	**	
		6 or 7	1-3/8"	N/A	1-3/8"	N/A													
		6 or 7	1-1/2"	N/A	1-1/2"	N/A													
Easton (CE)	6 or 7	1-5/8"	N/A	1-5/8"	N/A														
	6 or 7	1-3/4"	1765.062	1-3/4"	N/A														
	6	1-1/8"	N/A	1-1/8"	N/A	1-1/2"	N/A	1-3/8"	N/A	1-11/16"	1765.062	1-1/8"	**	1-1/2"	**	1-1/4"	**		
	6 or 7	1-1/4"	N/A	1-1/4"	N/A	1-11/16"	N/A	1-3/8"	N/A	1-11/16"	1765.062	1-1/4"	**	1-11/16"	**	1-3/8"	**		
	6 or 7	1-3/8"	N/A	1-3/8"	N/A														
	6 or 7	1-1/2"	N/A	1-1/2"	N/A														
Lenoir (LN)	6 or 7	1-5/8"	N/A	1-5/8"	N/A														
	6 or 7	1-3/4"	N/A	1-3/4"	N/A														
	6 or 7	1-7/8"	1765.062	1-7/8"	N/A														
	6	1-1/8"	N/A	1-1/8"	N/A	1-1/2"	N/A	1-3/8"	N/A	1-11/16"	1765.062	1-1/8"	**	1-1/2"	**	1-1/4"	**		
	6 or 7	1-1/4"	N/A	1-1/4"	N/A	1-11/16"	N/A	1-3/8"	N/A	1-11/16"	1765.062	1-1/4"	**	1-11/16"	**	1-3/8"	**		
	6 or 7	1-3/8"	N/A	1-3/8"	N/A														

*Single Cylinder Only
 **Consult Factory
 N/A = Application Not Available
Note: Copenhagen, Easton and Lenoir escutcheons discontinued. Information for reference only.

Cylinder Collars



For Use with Sectional and Escutcheon Trim with V Series Indicators

Door Thickness	Trim	Function	Cylinder Length	Collar Required
1-3/4" (44)	Sectional or Escutcheon	Single Cylinder	1-1/8"	No Collar
			1-1/4"	No Collar
			1-3/8"	1765.062
			1-1/2"	1765.094
			1-11/16"	1765.281
		Double Cylinder	1-1/8"	No Collar
			1-1/4"	N/A
			1-3/8"	1765.094
			1-1/2"	1765.219
			1-11/16"	1765.406
2" (51)	Sectional or Escutcheon	Single Cylinder	1-1/8"	N/A
			1-1/4"	No Collar
			1-3/8"	No Collar
			1-1/2"	1765.062
			1-11/16"	1765.187
		Double Cylinder	1-1/8"	N/A
			1-1/4"	No Collar
			1-3/8"	N/A
			1-1/2"	1765.094
			1-11/16"	1765.281
2-1/4" (57)	Sectional or Escutcheon	Single Cylinder	1-1/8"	N/A
			1-1/4"	N/A
			1-3/8"	No Collar
			1-1/2"	No Collar
			1-11/16"	1765.062
		Double Cylinder	1-1/8"	N/A
			1-1/4"	N/A
			1-3/8"	No Collar
			1-1/2"	N/A
			1-11/16"	1765.156

N/A = Application Not Available



Strikes

Yale® 8800 Series Mortise Locks come standard with a 2815 Curved Lip Strike with a 1-1/4" (32mm) lip length. The strike supplied will accommodate the locking function, i.e. latchbolt and/or deadbolt, and can be installed on doors 1-3/4" (44mm) thick. These strikes are non-handed.

Material: Brass, Stainless Steel.

Longer/Shorter Lip Lengths: Mortise lock strikes are mounted 3/8" above the center line of the lock. To determine the proper length of lip use the following formula:

1/2 of the door thickness, plus 1/16" inset, plus trim thickness, plus 1/8" for flat lip strike OR 1/4" for curved lip strike. Select the nearest available length.

2815 Curved Lip:

- 1-1/4" (32mm) standard
- To special order
 - 1-1/8" (29mm)
 - 1-3/8" (35mm)
 - 1-1/2" (38mm)
 - 1-5/8" (41mm)
 - 1-3/4" (44mm)
 - 1-7/8" (48mm)
 - 2" (51mm)
 - 2-1/8" (54mm)
 - 2-1/4" (57mm)

2816 Flat Lip:

- To special order,
 - 7/8" (22mm)
 - 1" (25mm)
 - 1-1/8" (29mm)
 - 1-1/4" (32mm)
 - 1-1/2" (38mm)
 - 1-3/4" (44mm)
 - 2" (51mm)
 - 2-1/4" (57mm)
 - 2-1/2" (64mm)

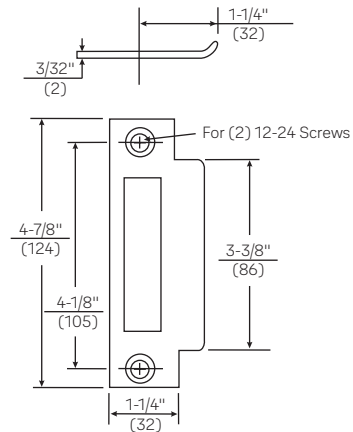

Optional Strikes

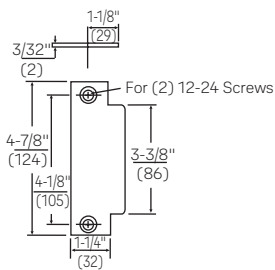

497B ANSI Blank Filler Plate: Reversible to replace a strike where a lock has been removed or where a frame with a strike preparation when no lock is installed on a door. Lip Lengths: 1-1/8" (29mm) only.

Material: Brass, Bronze, Stainless Steel.

718 Open Back Strike: Field handable for a standard V-beveled pair of doors with a latchbolt only function on the active door. This strike permits emergency opening of the inactive door without damaging the lock mechanism. Available for doors 1-3/4" or 2-1/4" thick only. Specify the door thickness required.

Material: Stainless Steel, Black Nylon Coated.

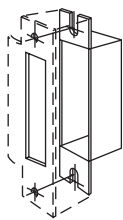

202 Strike Box: Reversible for installation with all Flat or Curved Lip Strikes. Available to special order only.

Material: Wrought Steel, Zinc Plated, Dichromated.

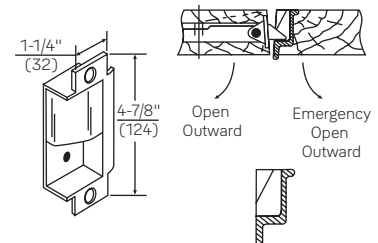



Rabbeted Door Kits

The Yale® 8800 Series Mortise Lock can be installed on a pair of doors with a standard 1/2" (13mm) step rabbet. Kits are available which adapt these locks to the rabbeted doors. These kits contain a 1/2" (13mm) standard step rabbet strip for the active door, a strike, a strike box, and, depending on the door thickness, a strike lip. They are available for doors 1-3/4" (44mm), 2" (51mm) and 2-1/4" (57mm) thick. All components of these kits are reversible.

To order a complete Yale mortise lock with a Rabbet Door Kit, suffix the lock model number with a Rabbeted Door by door thickness, hand and finish required, i.e. AU8807 x Rabbeted Door x 1-3/4" x RH x 626.

Kits for rabbeted doors can be ordered by model number separately from the accompanying chart. When ordered separately, specify the finish required.

Door Thickness	Rabbeted Door Kit Model No.	Strike Model No.
1-3/4" 2"	RK245	22E

These kits contain the above components plus a No. 22D strike lip with attaching screws for doors above 2".

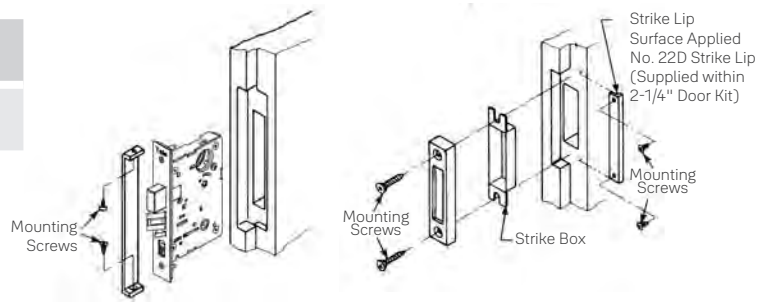

Miscellaneous Trim Design

GF1824 Thumbturn and Round Plate

Supplied as standard on all locks with round rose sectional trim or lock functions with no roses.

Thumbturn: Cast Zinc.
Plate: 1-7/8" (48mm) Diameter.
Brass, Simulated Stainless Steel.



GF1826 Plate for Privacy

Used for outside of 8802 Privacy Lock.
Plate: 1-7/8" (48mm) Diameter.
Brass, Simulated Stainless Steel.



GF1828 Blank Plate

For use on doors where thumbturn is no longer used.
Plate: 1-7/8" (48mm) Diameter.
Brass, Simulated Stainless Steel.



Attaching Screws

GF1824, GF1826 and GF1828

No. 6 x 3/8" (10mm) type "AB", Oval Phillips Head sheet metal screw, stainless steel plated to match trim (P/N 81-3173-0308). Specify finish required.

Emergency Key

E203

Used with 8802 privacy lock and 8862 bathroom lock for emergency access from outside.

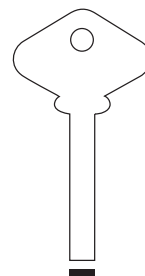

Handing The 8800 Mortise Lock

HANDING THE LATCHBOLT

1. Insert a flat blade screwdriver into cover slot.
2. Pull back on screwdriver until latchbolt extends past the base front.
3. Rotate head to desired position.

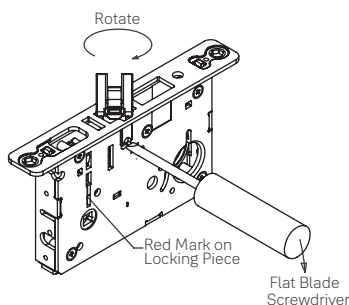

HANDING THE HUBS (LEVER OPERATION)

1. Locate the red mark on locking piece
2. The red mark indicates the locked side
3. Push toggle button to the "Unlock" position
4. With a flat blade screwdriver push red mark on locking piece to rotate locking piece 180° to the desired location
5. The locking piece must be fully rotated 180° for proper operation

Hand Of Doors

The outside is the key side of an entrance door or the corridor side of a room door. The outside of a single communicating door is the side opposite the hinges. The outside of twin communicating doors is the space between the doors.



Left Hand: Hinges on left, opens inward. For handed locks, specify LH.



Left Hand Reverse: Hinges on left, opens outward. For handed locks, specify LHR.



Right Hand: Hinges on right, opens inward. For handed locks, specify RH.



Right Hand Reverse: Hinges on right, opens outward. For handed locks, specify RHR.

Dimensions and Exploded Views



8800/SL8800 Series

- **Armor Front** - 8" x 1-1/4"
- **Door Thickness** - 1-3/4" standard, to 3-1/4" thick doors to order.
- **Deadbolt** - 1" throw, solid investment cast stainless steel.
- **Latchbolt** - 3/4" throw, stainless steel one-piece anti-friction.
- **Backset** - 2-3/4" only.
- **Case** - wrought steel, zinc dichromated.
- **Hubs** - 3/8" solid steel, fine-blanked and heat treated for additional strength.

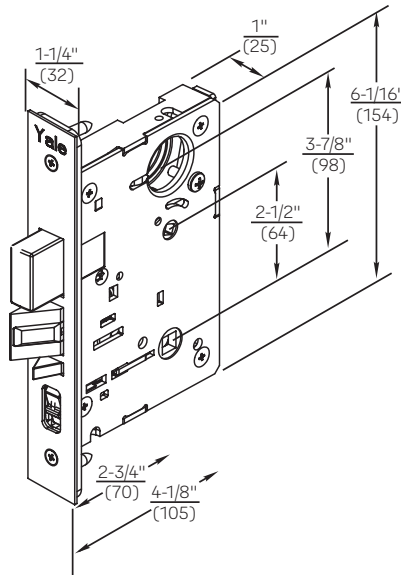

SL8800 Lever

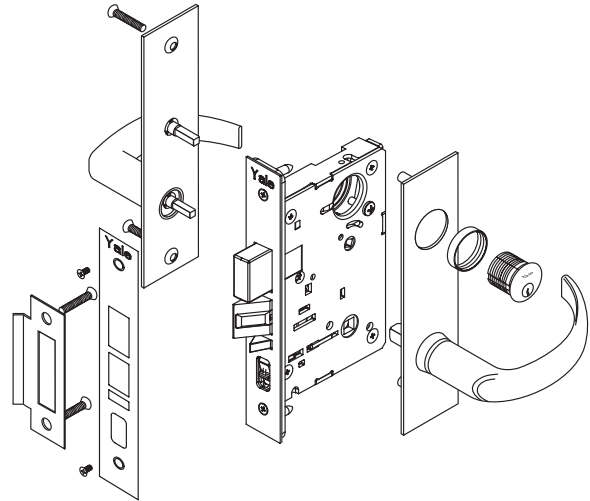

Standard Lever

Sectional

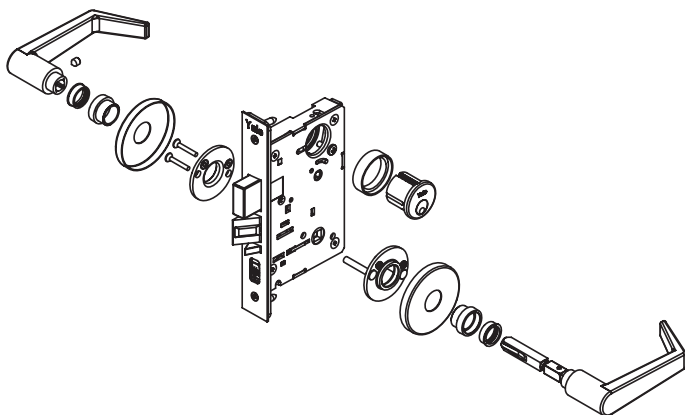

Escutcheon

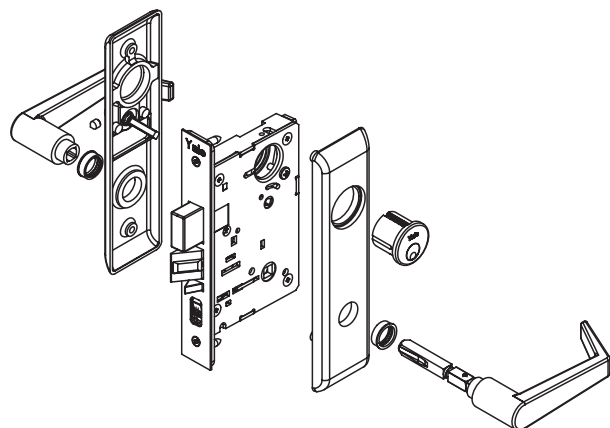

Reflections® Lever

Sectional

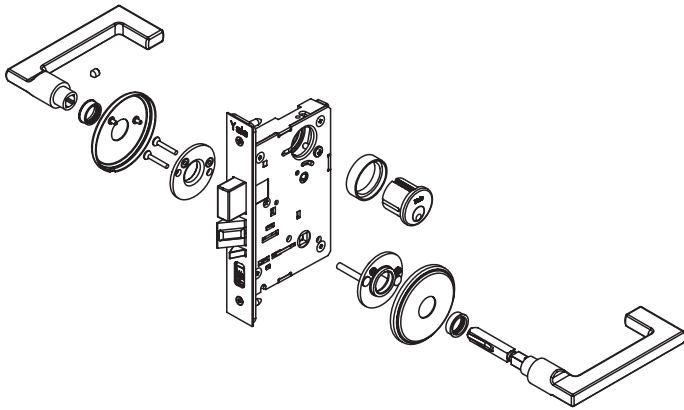

Escutcheon

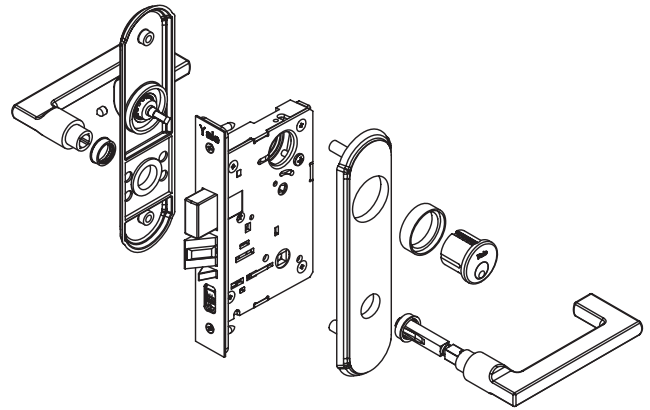

*When using Reflections levers with the CO rose, the rose adaptor is not used. Levers will not install and/or properly operate if rose adaptor is included.

Knob

Sectional

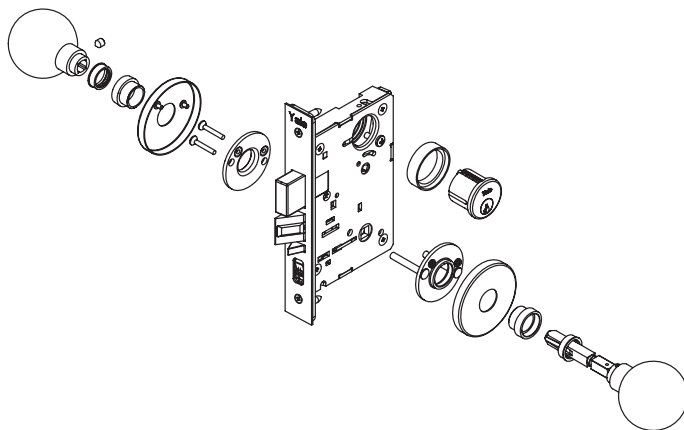

Escutcheon

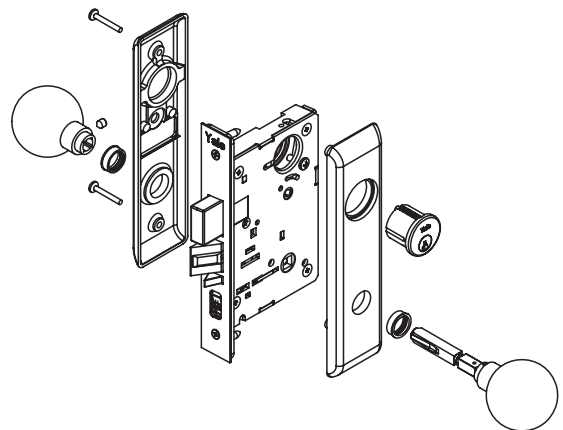



ADA



The 8800 meets accessibility guidelines of the Americans with Disabilities Act and the requirements of the Uniform Federal Accessibility standards and ANSI 117.1, all requiring ease of accessibility.

ANSI/BHMA



Certified ANSI/BHMA A156.13, Series 1000, Operational Grade 1 (8800FL with CN escutcheon & SL8800 meet Security Grade 1). 8800 Series Mortise Locks conform to ANSI/BHMA Specifications A156.115 which cover hardware preparations for steel doors and steel frames and A156.115-W which cover hardware preparations for wood doors with wood or steel frames.

Bevel Front

Yale 8800 series fronts are free-floating to adjust from flat to the standard bevel of 1/8" in 2".

Door Thickness

8800 Series Mortise Locks are supplied as standard for 1-3/4" thick doors. For other than standard, specify the door thickness on the order: (i.e. 2", 2-1/4", etc.)

Installation

Yale 8800 Series sectional and escutcheon trims feature thrubolted installation. Outside trim is held in place by threaded posts. For sectional trims, the posts fit through holes in the lock case and are secured by thrubolts from the inside trim. For escutcheon trims, the posts fit through the door and are secured by thrubolts from the inside trim. The posts fit through holes in the door, above and below the lock case, and are secured by thrubolts from the inside trim.

ISO 9001

Designed and manufactured under a certified ISO 9001 quality system.

Lead Shielding

All Yale 8800 Series Mortise Locks are available with a lead shield for installation in lead-lined doors. To order, suffix the lockset model number with "lead-lined."

Knurled Designs

Where required by the local authority, trim can be knurled to be identifiable to the touch for blind persons. CO knob design and all lever designs except HA and Reflections® trim (pages 10-12) may be ordered knurled.

Only the outside knob or lever will be knurled or abrasive coated unless specified otherwise. To order a complete lockset knurled or abrasive coated, suffix the lockset model number with "Knurled" or "Abrasive Coated," i.e. AU x CN8807 x "Knurled," AU x CN8817-2 x "Knurled Inside Only," AU x CN8828FL "Abrasive Coated."

Underwriters Laboratories (UL/cUL)



Yale 8800 Series Mortise Locks have been listed by Underwriters Laboratories Inc. for use on fire doors having a rating up to and including 3 hours and for use on 20 minute wood doors. This pertains to single swing doors not exceeding 4 feet in width and 8 feet in height and in doors mounted in pairs not exceeding 8 feet in either direction (unless otherwise noted in the individual listings.)

In general, single-point mortise locks or latches with 3/4" minimum latch throw are intended for the active leaf of doors mounted in pairs, with the inactive leaf provided with top and bottom flush or surface bolts of the manual, automatic, or self-latching type. The door Classification Marking specifies the minimum latch throw required for the individual door.

Yale 8800 Series Mortise Locks with 3/4" throw latchbolts may also be used on single swing doors rated 1-1/2 hours or less, up to 4 feet in width and 9 feet in height. This is in addition to the rating mentioned above. All Yale 8800 Series Mortise Locks with Lever Handle Trim are UL listed for fire door applications. Underwriters Laboratories does not list locks with rabbeted fronts, locks with deadbolt only, or locks with hold-back feature on the latchbolt.

Note: Any retrofit or other field modification to a fire rated opening can potentially impact the fire rating of the opening, and Yale Locks & Hardware makes no representations or warranties concerning what such impact may be in any specific situation. When retrofitting any portion of an existing fire rated opening, or specifying and installing a new fire-rated opening, please consult with a code specialist or local code official (Authority Having Jurisdiction) to ensure compliance with all applicable codes and ratings.

Warranty

Yale 8800 Series mechanical mortise locks are protected by a ten (10) year warranty and 8800 Series electrified mortise locks have a two (2) year warranty.

Windstorm

Certified (refer to local codes).



Hurricane





Trusted every day

Phone

1-855-557-5078

Customer Service Email

customerservice.yale@assaabloy.com

Technical Product Support Email

techsupport.yale@assaabloy.com

Order Entry Email

orders.yaleus@assaabloy.com

Fax

1-800-338-0965

Website

www.yalecommercial.com

Contact Us

U.S.A.

Yale Locks & Hardware

Address: 225 Episcopal Road

Berlin, CT 06037-4004

Tel: 1-800-438-1951

Fax: 1-800-338-0965

yalecommercial.com

Canada:

ASSA ABLOY Door Security Solutions Canada

Address: 160 Four Valley Drive

Vaughan, Ontario L4K 4T9

Tel: 1-800-461-3007

Fax: 1-800-461-8989

assaabloydss.ca

International:

ASSA ABLOY Americas International

Tel: 1-905-821-7775

Fax: 1-905-821-1429

assaabloyai.com

MicroShield®

ASSA ABLOY Group companies offer MicroShield®, an anti-microbial coating for door hardware. MicroShield uses proven silver ion-based technology from Agion®, a leading provider of antimicrobial solutions, to stem the spread of bacteria and other microbes.

MicroShield® is a registered trademark of ASSA ABLOY Access and Egress Hardware Group, Inc.



The Agion antimicrobial is not intended as a substitute for good hygiene. Coated products must still be cleaned to ensure the surfaces will be free of destructive microbes. ASSA ABLOY makes no representations or warranties, express or implied, as to the efficacy of the Agion antimicrobial. A copy of the Agion warranty is available upon request. Agion is a registered trademark of Agion Technologies, Inc., Wakefield, MA, USA.

THE YALE BRAND, with its unparalleled global reach and range of products, reassures more people in more countries than any other consumer locking solution.

THE ASSA ABLOY GROUP is the world's leading manufacturer and supplier of locking solutions, dedicated to satisfying end-user needs for security, safety and convenience.

Yale Commercial is a business associated with ASSA ABLOY Access and Egress Hardware Group, Inc., an ASSA ABLOY Group company. Copyright © 2004-2021, ASSA ABLOY Access and Egress Hardware Group, Inc. All rights reserved. Reproduction in whole or in part without the express written permission of ASSA ABLOY Access and Egress Hardware Group, Inc. is prohibited. Patent pending and/or patent www.assaabloydss.com/patents.



reflections[®]

inspiring decorative levers
coordinating hardware



Reflecting your design vision everywhere

Yale lever profiles echo your design statement, whether you require sleek and contemporary or dramatic vibrancy to create a unique architectural environment. Now it's possible to flow design sensibility across the entire facility, unifying all openings.

Select from 34 available lever styles in 13 finishes to complement and expand upon the message of any interior. With Reflections, style is uniquely defined.

Inspired by the fluid lines in nature, this collection of distinctive decorative levers mirrors the sensibility of design in high-end commercial projects.

Encapsulating natural elements of form found in flowing water and landscapes, each lever in the **Reflections** series captures a unique beauty, styled with its own distinctive characteristics. Simple curves mixed with dramatic arcs provide options for every project.





Let one lever design unify all openings across a facility

Coordinate all door hardware whether tubular, mortise, exit or access control with the selection of one decorative lever.

The **Reflections** lever collection enables design professionals to express their vision for detail across all openings.

Tubular

Hotel rooms
Apartments
Condominiums

Mortise

Government
Mixed-use facilities
Commercial offices
Universities

Exit Devices

Lobbies
Retail
Conference centers
Egress doors

Electronic Access Control

Corporate enterprise
Government buildings
Multi-family and senior living
Mixed-use facilities



Tubular – Engineered for ease of installation, the RL series tubular locks were designed to work with Reflections. Specify a decorative lever to marry functionality with design throughout any building or facility.



Mortise – Let one lever design enhance the security in higher traffic areas. No need to compromise design for strength with 8800RL mortise locks.



Exit Devices – Add a Reflections lever to a narrow or wide stile exit device bringing gracious totality to the entire complex – with a push bar on one side of the door, decorative lever on the other.



Access Control – Specify your lever selection to be used on an access control trim on exit devices or mortise lock openings.

Hudson

Niagara

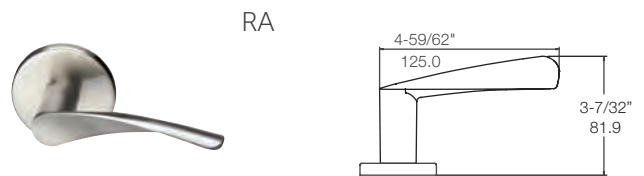
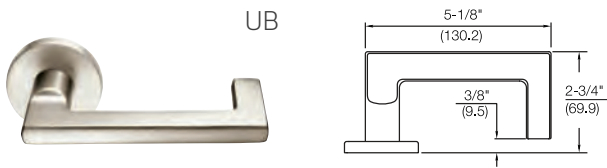
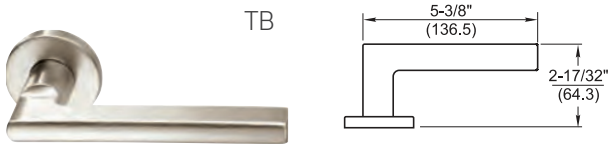

Lever returns within 1/2" (13mm) of door face

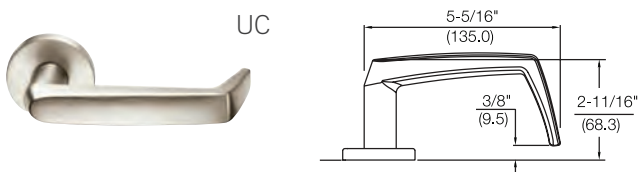
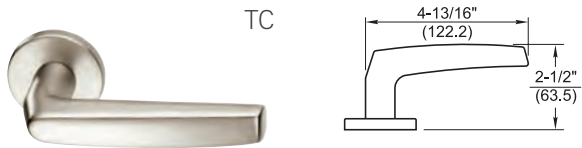

Lever returns within 1/2" (13mm) of door face

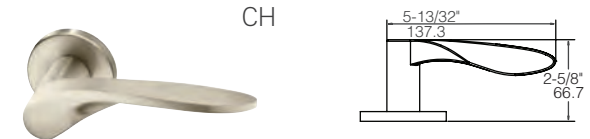

Thames



TM

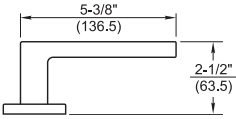

TR

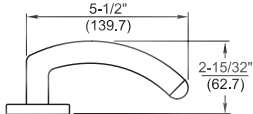

TN

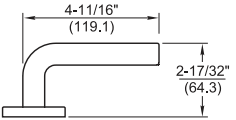

TS

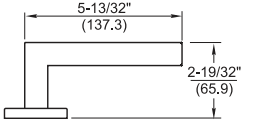

TP

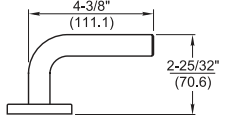

TQ

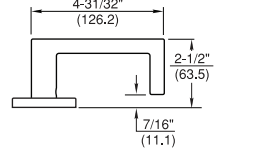

Lever returns within 1/2" (13mm) of door face

Spree

Seine

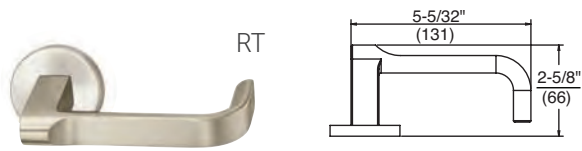
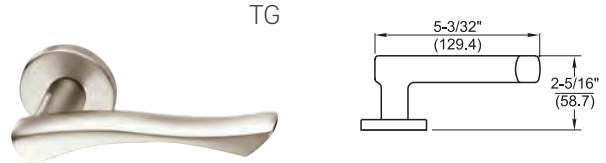
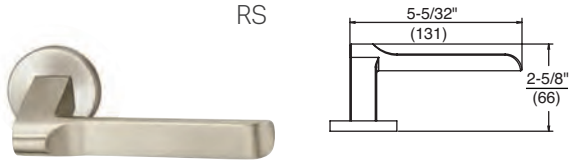

Lever returns within 1/2" (13mm) of door face

Lever returns within 1/2" (13mm) of door face

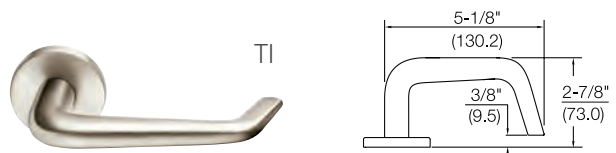
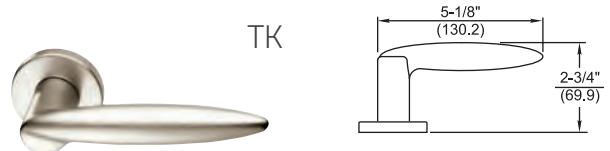
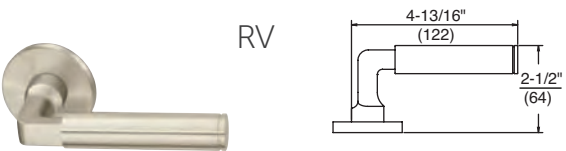
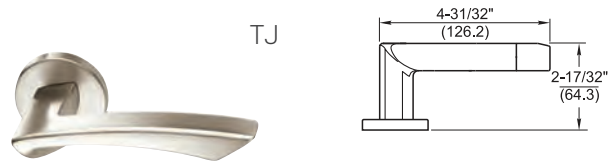
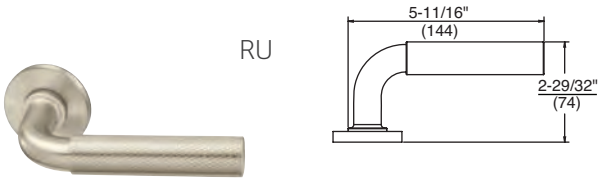

Lever returns within 1/2" (13mm) of door face

Victoria



TT

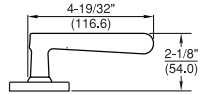

TU

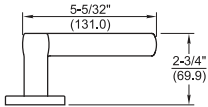

TX

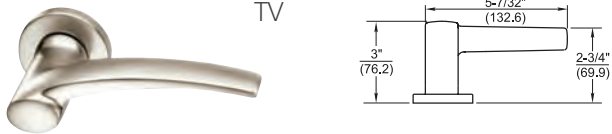
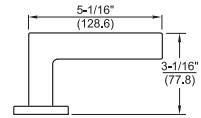

TV

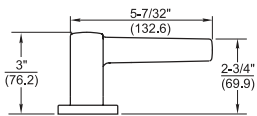

UX

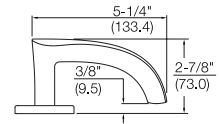

Lever returns within 1/2" (13mm) of door face

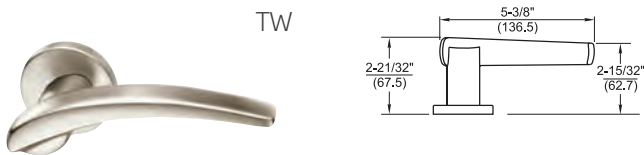

TW

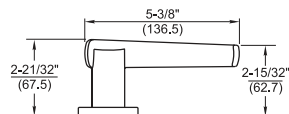

TY

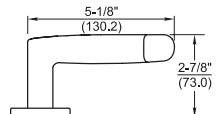

UW

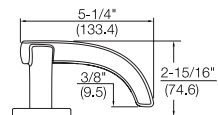

Lever returns within 1/2" (13mm) of door face



TZ

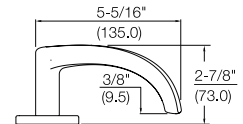

Lever returns within 1/2" (13mm) of door face

Finishes

605 | US3

Bright Brass
Clear Coated



606 | US4

Satin Brass
Clear Coated



611 | US9

Bright Bronze
Clear Coated



612 | US10

Satin Bronze
Clear Coated



613E | US10BE

Dark Oxidized
Satin Bronze
Equivalent



618 | US14

Bright Nickel Plated
Clear Coated



619 | US15

Satin Nickel Plated
Clear Coated



625 | US26

Bright Chrome Plated



626 | US26D

Satin Chrome Plated



629 | US32*

Bright Stainless Steel



630 | US32D*

Satin Stainless Steel



BSP

Black Suede
Powder Coat



WSP

White Suede
Powder Coat



Roses & Escutcheons



RL tubular lock roses

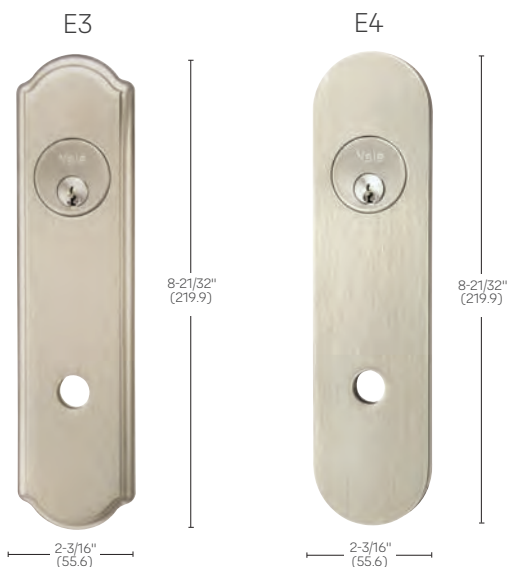
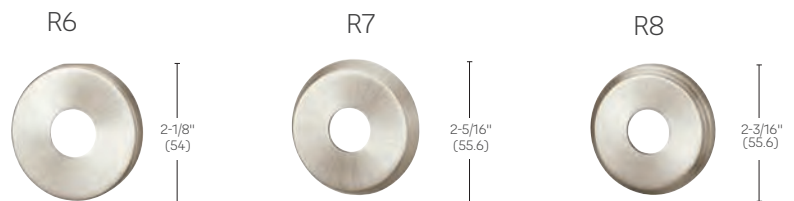
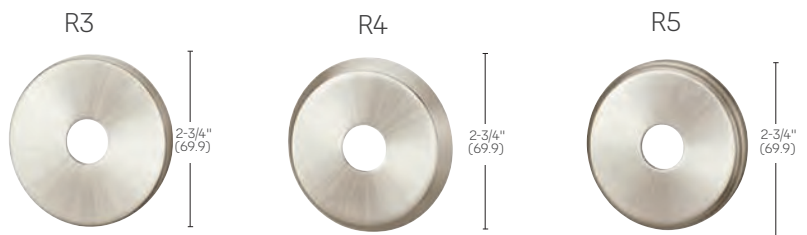

8800RL mortise lock roses & escutcheons

*Select levers are not available in 629 or 630 finishes: Hudson TD; Danube TI; Seine TG, TJ, TK, and TO; Niagara and Victoria collections.

Hudson



Thames



Victoria*

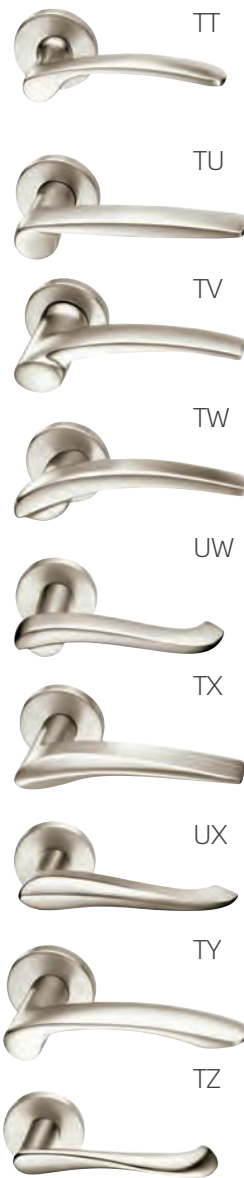

Niagara*



Spree



Seine*



All levers meet ADA guidelines

*Not available in 629 or 630 finishes.



Trusted every day

Phone

1-855-557-5078

Customer Service Email

customerservice.yale@assaabloy.com

Technical Product Support Email

techsupport.yale@assaabloy.com

Order Entry Email

orders.yaleus@assaabloy.com

Fax

1-800-338-0965

Website

www.yalecommercial.com

Contact Us

U.S.A

Yale Locks & Hardware

Address: 225 Episcopal Road

Berlin, CT 06037-4004

Tel: 1-800-438-1951

Fax: 1-800-338-0965

yalecommercial.com

Canada:

ASSA ABLOY Door Security Solutions Canada

Address: 160 Four Valley Drive

Vaughan, Ontario L4K 4T9

Tel: 1-800-461-3007

Fax: 1-800-461-8989

www.assaabloydss.ca

International:

ASSA ABLOY Americas International

Tel: 1-905-821-7775

Fax: 1-905-821-1429

assaabloyai.com

To learn more
visit: selector.yalecommercial.com
or contact your local ASSA ABLOY
Door Security Solutions team

THE YALE BRAND, with its unparalleled global reach and range of products, reassures more people in more countries than any other consumer locking solution.

THE ASSA ABLOY GROUP is the world's leading manufacturer and supplier of locking solutions, dedicated to satisfying end-user needs for security, safety and convenience.

Yale Commercial is a business associated with ASSA ABLOY Access and Egress Hardware Group, Inc., an ASSA ABLOY Group company. Copyright © 2021, ASSA ABLOY Access and Egress Hardware Group, Inc. All rights reserved. Reproduction in whole or in part without the express written permission of ASSA ABLOY Access and Egress Hardware Group, Inc. is prohibited. Patent pending and/or patent www.assaabloydss.com/patents.



5400LN Series

Grade 1 Cylindrical Lever Locks





Contents

Benefits & Features.....	3
How to Order.....	4
Finishes.....	5
Lever Trim.....	6
Functions.....	7-9
Electrified Options.....	10
Electrified Accessories.....	11
Cylinders.....	12-13
Latchbolts.....	14
Strikes.....	15
Sample Specification.....	16
Technical Specifications & Listings.....	17

5400LN Series Cylindrical Lever Locks

Designed for industrial and commercial use, Yale 5400LN Series heavy-duty cylindrical lockset offers rugged reliability and performance in a range of functions. With innovative features such as our Free Wheeling lever mechanism, wear-resistant chassis plates, heavy-duty lever return springs and thru-bolting, this Grade 1 workhorse is favored for a variety of applications that require reliable access every day.

Offering quality door hardware products from a brand you can trust, Yale Works for YouSM.



Benefits & Features

Benefits

- **Heavy-Duty:** Rugged Grade 1 construction offers greater reliability and resists wear-and-tear
- **Secure:** Innovative features protect against damage and vandalism
- **Versatile:** Range of functions and options offer an ideal solution for a variety of commercial applications
- **Easy installation:** Adjustable rose allows for easy adjustment on different door thicknesses
- **Strong & Reliable:** ANSI/BHMA Grade 1 certification for long-life and durability

Features

- Heavy duty construction features wear-resistant chassis plates, longer thread-locking thrubolts, lifetime warranted lever return springs and stainless steel latchbolt for exceptional strength and durability
- Free Wheeling lever mechanism prevents vandalism and reduces maintenance
- Adjustable rose support plates
- Available in 3 lever designs, 24 functions (including electrified) and 12 standard finishes
- ANSI/BHMA Certified Grade 1
- ADA compliant for ease of accessibility

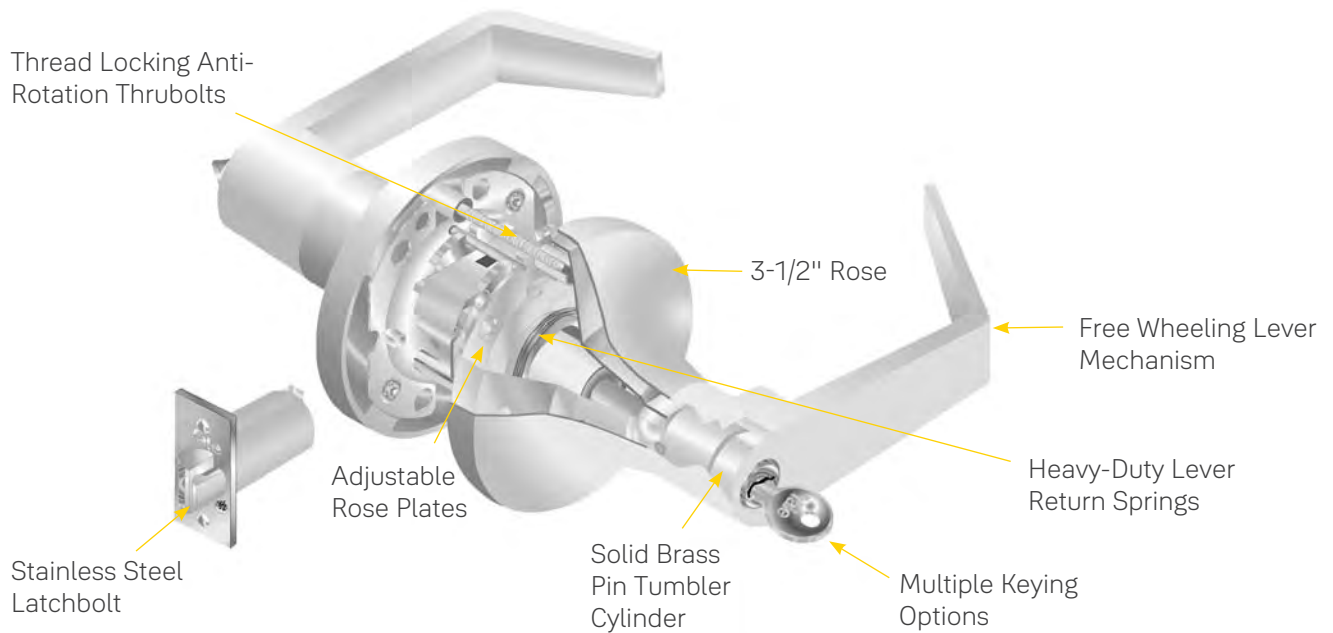

Specifications

Backset	2-3/4" standard, 3-3/4" optional
Door Thickness	Adjustable for doors 1-3/4" to 2"
Handing	Non-handed, field reversible
Latchbolt	2-3/4" backset, 1/2" throw. See page 14 for additional options.
Strike	ANSI strike 4-7/8" x 1-1/4" x 1-1/4" lip to center. See page 15 for additional options.
ANSI/BHMA	Certified Grade 1, ANSI/BHMA A156.2
UL/cUL	Listed for 3 hour fire doors
Windstorm	Certified, check local codes.
Warranty	7 years



How To Order



Trim Design	Function	Option	Hand	Latch	Strike	Cylinder	Door Thickness	Keying	Finish
AU = Augusta	5401LN	REX - See page 10 TD - See note below	Specify RH LH	See page 14 for options.	497 ANSI strike standard, see page 15 for additional options.	1802 6-pin cylinder standard, see pages 12-13 for additional options.	1-3/4" standard, see page 17 for more information.	See page 12-13	605
MO = Monroe	5402LN								606
PB = Pacific Beach	5403LN								609
	5404LN								612
	5405LN								613E
	5406LN								616
	5407LN								619
	5408LN								620
	5409LN								625
	5417LN								626
	5418LN								693
	5421LN								BSP
	5422LN								WSP
	5425LN								
	5428LN								
	5429LN								
	5430LN								
	5439LN								
455LN									
455LN-D									
See pages 7-9 for more details.									

Ordering Example

Trim Design	Function	Option	Hand	Latch	Strike	Cylinder	Door Thickness	Keying	Finish
AU	5407LN	TD	RH	F694	497	1802	1-3/4"	KR	626

FEMA 320

With the addition of longer thru-bolt screws, the 5400LN can be used in conjunction with a Ceco StormPro® 320 door and frame and Medeco® Maxum Security deadbolts to meet the standards of the FEMA 320 Large Missile Impact test. To order these screws, add option "TD" to the model number and the correct screws will be supplied. For example: AU5407LN x TD.

Packing

Each box has a strike, paper template, combination wood and machine screws, lever release tool and easy-to-follow instructions. Cylinder functions supplied with two keys. Ten shelf boxes to a case.

Finishes



ANSI/BHMA Code Finish Description				
605 Bright Brass, Clear Coated	606 Satin Brass, Clear Coated	609 Satin Brass, Blackened, Satin Relieved, Clear Coated	612 Satin Bronze, Clear Coated	613E Dark Oxidized Satin Bronze - equivalent
616 Satin Bronze, Blackened, and Satin Relieved, Clear Coated	619* Satin Nickel Plated, Clear Coated	620 Satin Nickel Plated, Blackened, Satin Relieved, Clear Coated	625 Bright Chrome Plated	626* Satin Chrome Plated
693 Black Painted	BSP Black Suede Powder Coat	WSP White Suede Powder Coat		

613 and 722 finishes available by Special Product Request only. Please contact Customer Service for additional information.

*Finish available with MicroShield® antimicrobial coating, additional finishes by special application. Consult factory for availability.

MicroShield coating may vary finish color from architectural standards. MicroShield is not intended as a substitute for traditional infection control programs such as hand hygiene or use of disinfectants. Coated products must still be cleaned to ensure the surfaces will be free of destructive microbes. Yale makes no representations or warranties, express or implied, as to the efficacy of MicroShield.

Lever Trim



Augusta AU

Lever: Cast Zinc
Rose: Wrought Brass

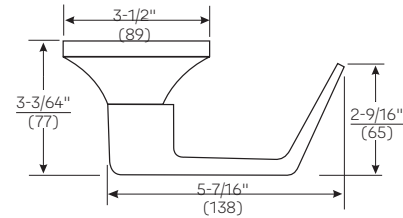

Monroe MO

Lever: Cast Zinc
Rose: Wrought Brass

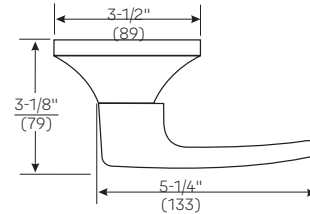

Pacific Beach PB

Lever: Cast Zinc
Rose: Wrought Brass

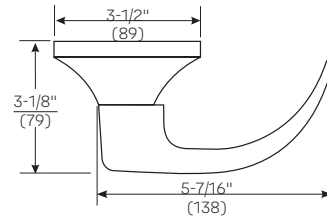

Available with large and small format interchangeable core. See page 12-13 for details.
Dimensions shown are in inches/mm.

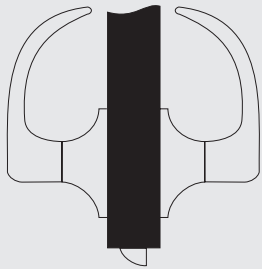
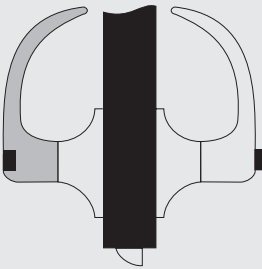
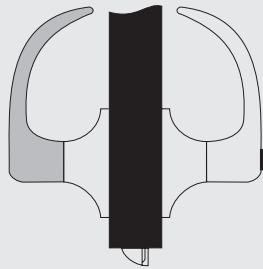
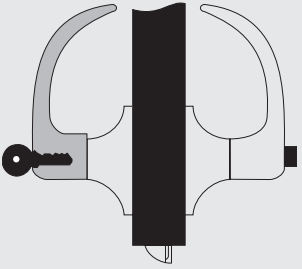
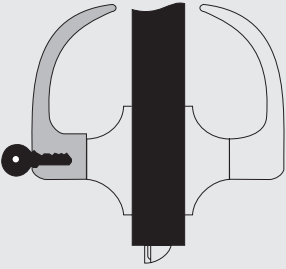
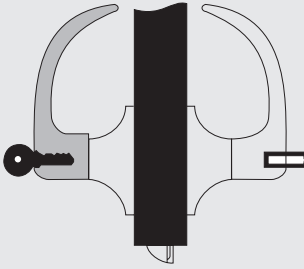

5401LN (F75)	5402LN (F76A)	5403LN (F77A)
<p>Passage or Closet Latch</p> <ul style="list-style-type: none"> For doors that do not require locking. Either lever operates latchbolt at all times.  <p style="text-align: center;">Outside Inside</p>	<p>Privacy, Bedroom or Bath Lock</p> <ul style="list-style-type: none"> For lavatory or other privacy doors. Either lever operates latchbolt unless outside lever is locked by pushbutton inside.* Button automatically releases when inside lever is turned or door is closed. Emergency release in outside lever. Emergency key supplied. (PN 14-5302-1053-048) Inside lever always active.  <p style="text-align: center;">Outside Inside</p>	<p>Patio or Privacy Lock</p> <ul style="list-style-type: none"> For exit doors with limited entry. Deadlocking latchbolt. Either lever operates latchbolt unless outside lever is locked by pushbutton inside.* Button automatically releases when inside lever is turned or door is closed. Inside lever always active.  <p style="text-align: center;">Outside Inside</p>
5404LN (F82A)	5405LN (F86)	5406LN (F92)
<p>Entry Lock</p> <ul style="list-style-type: none"> For entrance or office doors. Deadlocking latchbolt. Either lever operates latchbolt (except when outside lever is locked from inside).* Pushing button in inside lever locks outside lever. (Automatically releases when inside lever is turned or key is rotated in locked outside lever.) Latchbolt is operated by key in outside lever or by rotating inside lever. Inside lever always active.  <p style="text-align: center;">Outside Inside</p>	<p>Storeroom or Closet Lock</p> <ul style="list-style-type: none"> For use on storeroom, utility, and exit doors. Deadlocking latchbolt. Latchbolt operated by lever inside, key in outside lever. Outside lever always locked.* Inside lever always active.  <p style="text-align: center;">Outside Inside</p>	<p>Service Station Lock</p> <ul style="list-style-type: none"> Deadlocking latchbolt. Either lever operates latchbolt. Pushbutton in inside lever locks outside lever. (Automatically releases when inside lever is turned, door is closed or key is rotated in outside lever, except when slotted pushbutton is rotated 90° clockwise to retain outside lever in locked position).* Latchbolt operated by key in outside lever, inside lever always active.  <p style="text-align: center;">Outside Inside</p>

*Lever handles are Free Wheeling in locked position. Shaded area denotes Free Wheeling lever.

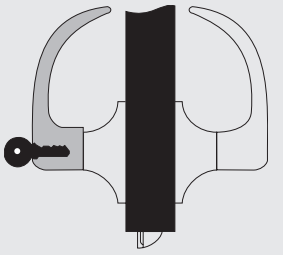
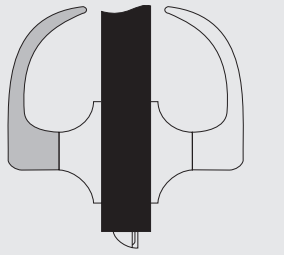

5407LN (F109)	5408LN (F84)	5409LN (F89)
<p>Entry Lock</p> <ul style="list-style-type: none"> • For entrance, general home or office doors. • Deadlocking latchbolt. • Either lever operates latchbolt (except when outside lever is locked from inside).* • Pushing turn button in inside lever locks outside lever, and automatically releases when inside lever is turned or key is rotated in locked outside lever. • Outside lever may be retained in locked position by pushing and rotating turn button 90° clockwise to a horizontal position; not released until turn button is manually returned to the vertical position. • Latchbolt is operated by key in outside lever or by rotating inside lever. • Inside lever always active.  <p style="text-align: center;">Outside Inside</p>	<p>Classroom Lock</p> <ul style="list-style-type: none"> • For classroom or utility room doors. • Deadlocking latchbolt. • Either lever operates latchbolt (except when outside lever is locked by key).* • Inside lever always active. • Outside lever locked* or unlocked only by key.  <p style="text-align: center;">Outside Inside</p>	<p>Exit Latch</p> <ul style="list-style-type: none"> • For exit doors with no-entry desired. • Deadlocking latchbolt. • Outside lever always locked.* • Inside lever always active.  <p style="text-align: center;">Outside Inside</p>
5417LN (F88)	5418LN (F110)	5421LN (F80)
<p>Apartment, Exit or Public Toilet Lock</p> <ul style="list-style-type: none"> • For office or apartment building entrance doors or lavatory doors. • Deadlocking latchbolt. • Either lever operates latchbolt (except when outside lever is locked by key from inside).* • Key in outside lever operates latchbolt. • Inside lever always active. <p>NOTE: Inside handle requires 1802S standard 6-pin cylinder.</p>  <p style="text-align: center;">Outside Inside</p>	<p>Intruder Classroom Lock</p> <ul style="list-style-type: none"> • For classroom doors. • Deadlocking latchbolt. • Either lever operates latchbolt (except when outside lever is locked by key from either side). • Outside lever remains locked upon egress. • Inside lever always active.  <p style="text-align: center;">Outside Inside</p>	<p>Communicating Lock</p> <ul style="list-style-type: none"> • For communicating or store entrance doors. • Deadlocking latchbolt. • Either lever operates latchbolt (except when key in either lever locks or unlocks the lever independently of the other).* • Should be used only in offices or rooms with multiple entries. <p>NOTE: Not available with IC core cylinders.</p>  <p style="text-align: center;">Outside Inside</p>

*Lever handles are Free Wheeling in locked position.
Shaded area denotes Free Wheeling lever.

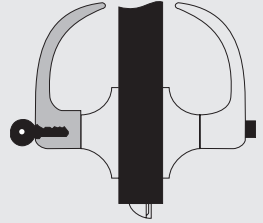
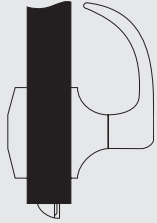
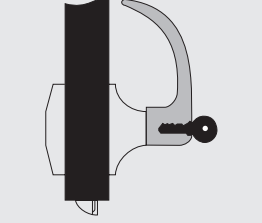

5422LN (F90)	5425LN	5428LN (F111)	5429LN (F113)
<p>Corridor Lock</p> <ul style="list-style-type: none"> • Deadlocking latchbolt. • Either lever operates latchbolt (except when outside lever is locked by inside pushbutton or key in outside lever). * Inside lever always active. • When locked by button, the button automatically releases when inside lever is turned or door is closed. • When locked by key, the automatic release is made inoperative and must be manually unlocked by the key.*  <p style="text-align: center;">Outside Inside</p>	<p>Privacy Lock</p> <ul style="list-style-type: none"> • For lavatory or other privacy doors. • Either lever operates latchbolt (except when outside lever is locked by inside pushbutton). * • Button automatically releases by turning inside lever or closing door. • Door can be unlocked, when necessary, by operating outside turnbutton. • No emergency key required. • Optional flush turnbutton available for outside. Specify option "FTB".  <p style="text-align: center;">Outside Inside</p>	<p>Communicating Passage Lock</p> <ul style="list-style-type: none"> • For twin communicating or exit doors where one side operation is required. • Use where space is limited. • Deadlocking latchbolt. • One lever operation. • Blank rose. • Should be used only where rooms have more than one entrance.  <p style="text-align: center;">Outside Inside</p>	<p>Communicating Classroom Lock</p> <ul style="list-style-type: none"> • For twin communicating or closet doors where one side operation or space between doors is limited. • Deadlocking latchbolt. • Blank rose. • Inside lever operates latchbolt except when lever is locked by key.* • Should be used only where rooms have more than one entrance. <p>(Not available with IC core cylinders.)</p>  <p style="text-align: center;">Outside Inside</p>
5430LN (F87)	5439LN (F112)	455LN	455LN-D
<p>Utility, Asylum or Institutional Lock</p> <ul style="list-style-type: none"> • Deadlocking latchbolt. • Latchbolt operated by key in lever from either side. • Both levers always locked.* <p>Note: Not available with IC core cylinders.</p>  <p style="text-align: center;">Outside Inside</p>	<p>Communicating Storeroom Lock</p> <ul style="list-style-type: none"> • For twin communicating or closet doors where one side operation is required or space between doors is limited. • Deadlocking latchbolt. • Latchbolt operated by key only in inside lever. • Inside lever always locked.* • Blank rose. • Should be used only where rooms have more than one entrance. <p>(Note: Not available with I.C. core cylinders)</p>  <p style="text-align: center;">Outside Inside</p>	<p>Dummy Trim</p> <ul style="list-style-type: none"> • For non-operational lever used for decorative trim.  <p style="text-align: center;">Outside Inside</p>	<p>Double Dummy Trim</p> <ul style="list-style-type: none"> • For non-operational lever used for decorative trim.  <p style="text-align: center;">Outside Inside</p>

*Lever handles are Free Wheeling in locked position. Shaded area denotes Free Wheeling lever.

Electrified Options



Operation

Electric locks provide the ability to electrically lock or unlock the outside trim from a remote location. Fail Safe locks are commonly used in stair towers to release upon fire alarm activation. Fail Secure locks are used on perimeter doors or security doors to allow ingress using access control technologies (proximity cards, keypads, etc.)



Features

- Free Wheeling lever mechanism.
- Self-contained, continuous-duty integral solenoid (allows installation in standard cylindrical prep).
- Available Fail Safe or Fail Secure.
- Available in 12 or 24 volts DC.
- 8 position ElectroLynx plug connector
- External rectifier available upon request for AC operation.
- Mechanical cylinder override.
- All 5400LN cylinder options.
- Certified ANSI/BHMA Grade 1. 
- UL listed.
- 2-year limited warranty.

Electrical Specifications

- Continuous duty solenoid
150 mA @ 24VDC
300 mA @ 12VDC
- REX (SPDT) Contact Rating:
3A @ 125 VAC
2A @ 24 VDC

Electrolynx®

Yale® electrified 5400LN locks are equipped with ElectroLynx connectors. As a standard feature, these connectors link power from the incoming source to electrified locking products, including hinges, locks, exit devices, magnetic holders and strikes.







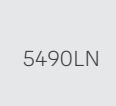

Note: Electrified door hardware with ElectroLynx connectors requires a compatible number of lead wires attached to the door hinge.

Request to Exit (REX) Option

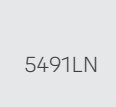
Operating inside lever handle triggers REX switch which can be used to shunt an alarm, monitor egress or release a magnetic lock, etc.

Functions

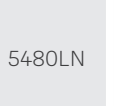
Outside	Inside	Function	Function Description
		5490LN	Fail Safe <ul style="list-style-type: none"> • Power on locks outside lever. • Inside lever always active. • Latchbolt retracted by key when locked electrically. • Free Wheeling lever when locked electrically.
		5491LN	Fail Secure <ul style="list-style-type: none"> • Power on unlocks outside lever. • Inside lever always active. • Latchbolt retracted by key when power is off. • Free Wheeling lever when power is off (locked).

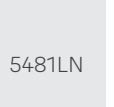
Outside	Inside	Function	Function Description
		5480LN	Fail Safe <ul style="list-style-type: none"> • Power on locks outside lever. • Inside lever always active. • Latchbolt retracted either side except when outside lever is locked electrically. • Free Wheeling lever when locked electrically.
		5481LN	Fail Secure <ul style="list-style-type: none"> • Power on unlocks outside lever. • Inside lever always active. • Latchbolt retracted either side when power is off. • Free Wheeling lever when power is off (locked).

Electrified Accessories



BPS Power Supplies By Securitron®

Operation

Power supplies are designed to provide reliable filtered and regulated power for long life to a variety of electrified hardware components.

Product Features

- Individual output circuit breakers
- Regulated and filtered fuse protected outputs
- LEDs monitor zone status (voltage or no voltage)
- Slide switches connect or disconnect load from power (Not available on 1 Amp supplies)
- Internal Back-Up battery charging circuit
- Rugged steel enclosure
- Fire alarm interface

Listings

- UL CLASS 2

Applications (use with):

- Fail Safe cylindrical locks
- Fail Secure cylindrical locks

Ordering

Ex: BPS-24-4, BPS-12-3

Model	Input	Output	Application
BPS-24-1	120 VAC	1 Amp @ 24 VDC	2-5400LN
BPS-24-2	120 VAC	2 Amp @ 24 VDC	5-5400LN
BPS-24-4	120 VAC	4 Amp @ 24 VDC	11-5400LN
BPS-12-1	120 VAC	1 Amp @ 12 VDC	1-5400LN
BPS-12-3	120 VAC	3 Amp @ 12 VDC	3-5400LN

Consult factory for additional power supply applications.

Yale recommends McKinney®, Pemko and Securitron® for power transfer devices and other electronic accessories.

Cylinders



Cylinder Options

The following selection guide indicates the correct cylinder for each locking segment.

Lockset Series: 5400LN		Types of Cylinder Mechanisms						
		Conventional		Protected Keyway		Security		
Cylinder Types	Fixed Core	6-pin	7-pin	6-pin	7-pin	6-pin	7-pin	
	Key-In-Lever	1802	1802A	K402	K402	5802	5802A	
	Interchangeable Core							
	LFIC	1210	1220	K800	K800	5210	5220	
SFIC	A600	A600	K600	K600	N/A	N/A		

Refer to Yale® KeyMark® and/or Cylinders and Keys Catalog sections for all details and how to order examples.

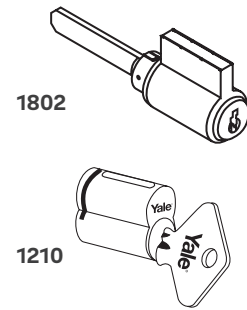

Yale® KeyMark®

For those applications requiring protected key control, Yale® KeyMark® cylinders guard against unauthorized key duplication. The Yale KeyMark Security Leg® keyway feature increases resistance against picking and impressioning and can easily retrofit into existing systems. For further details and availability, refer to the separate Yale KeyMark catalog.

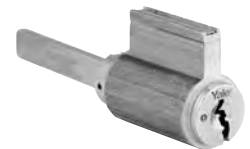

Security Cylinders

Security cylinders contain two independent locking mechanisms. The first is a traditional 6- or 7-pin tumbler mechanism with spool drivers for greatly increased picking resistance.

The second is an innovative 5-tumbler rotating disc mechanism with sidebar engagement. The rotating discs are spring loaded and block the bottom of the keyway.

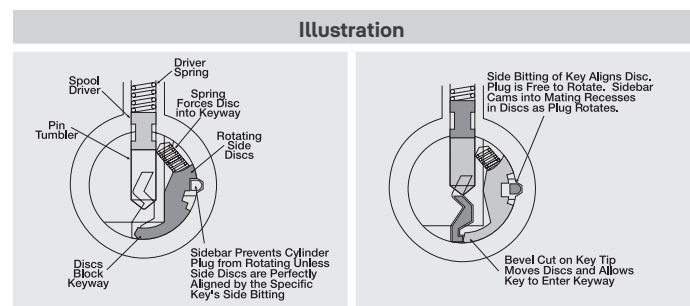

Cylinders



107S Schlage® Cylinder Adapter Kit

Used to modify Schlage cylinder for fit in the 5400LN.
P/N 14-5407-0300-048

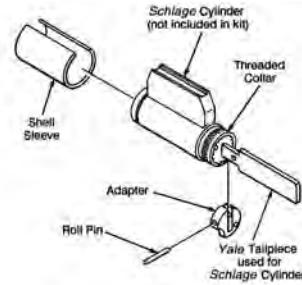

Other Manufacturer Keyway Cylinders

Illustration	Description	Model Number	Number of Pins
	Best® Keyway Cylinder. Available keyed random, master keyed or uncombined. Specify keyway A, B, C, D, E, F, G, H, J, K, L or M.	A600	6 or 7
	Corbin Russwin "L4", Corbin "60", Russwin "D1", Sargent® "LA" or Schlage® "E" Keyway. Specify keyway. Available keyed random.	3804*	6
	Schlage® "C" Keyway. Available 0-bitted or keyed random.	2802	6

***3804 cylinders require the 107S cylinder adapter kit to fit the 5400LN locksets. These cylinders are not ANSI/BHMA certified.**

Levers Accepting SFIC And Other Manufacturers' Large Format Interchangeable Cores

Illustration	Description	Prefix	Number of Pins
	SFIC (Accepts all Small Format Interchangeable Cores)	B (i.e. B-AU, B-MO, B-PB)	6 or 7
	Medeco®, ASSA® (LFIC)	M* (i.e. M-AU)	6
	Schlage® (LFIC)	SI (i.e. SI-AU, SI-PB, SI-MO)	6

***Medeco®, ASSA® option available only with AU lever. (Note: For Medeco 32 series cores.)**

LFIC = Large Format Interchangeable Core

SFIC = Small Format Interchangeable Core



Plain Latchbolts

Model No. 693 supplied standard with all 5400LN series locksets without locking function. Standard plain latchbolt has a 2-1/4" (57mm) x 1-1/8" (29mm) beveled front with a 2-3/4" (70mm) backset and a 1/2" (13mm) bolt throw. Optional latchbolts with a greater backset/throw available to special order.

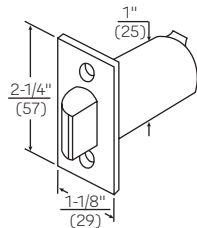

Model No.	Front	Backset	Throw	Front Width	Latch Diameter
693	Beveled	2-3/4" (70mm)	1/2" (13mm)	1-1/8" (29mm)	1" (25mm)
F693	Flat	2-3/4" (70mm)	1/2" (13mm)	1-1/8" (29mm)	1" (25mm)
3693	Beveled	3-3/4" (95mm)	1/2" (13mm)	1-1/8" (29mm)	1" (25mm)

Note: for 3/4" throw applications, only deadlocking latchbolts available.

Deadlocking Latchbolts

Deadlocking latchbolt Model No. 694 supplied standard with all 5400LN series locksets with locking function. Standard deadlocking latchbolt has a 2-1/4" (57mm) x 1-1/8" (29mm) beveled front with a 2-3/4" (70mm) backset and a 1/2" (13mm) bolt throw. Optional latchbolts with a greater backset/throw available to special order.

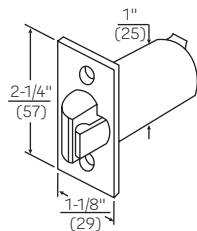

Model No.	Front	Backset	Throw	Front Width	Latch Diameter
694	Beveled	2-3/4" (70mm)	1/2" (13mm)	1-1/8" (29mm)	1" (25mm)
F694	Flat	2-3/4" (70mm)	1/2" (13mm)	1-1/8" (29mm)	1" (25mm)
3694	Beveled	3-3/4" (95mm)	1/2" (13mm)	1-1/8" (29mm)	1" (25mm)
480B	Beveled	2-3/4" (70mm)	3/4" (19mm)	1-1/8" (29mm)	1" (25mm)
F480B	Flat	2-3/4" (70mm)	3/4" (19mm)	1-1/8" (29mm)	1" (25mm)
3480B	Beveled	3-3/4" (95mm)	3/4" (19mm)	1-1/8" (29mm)	1" (25mm)

Note: for 2-3/8" backset, contact Customer Support.

Backset Extension Links

All 5400LN Series locksets are supplied with standard latchbolts of 2-3/4" (70mm) backset; optional latchbolts with a 3-3/4" (95mm) backset are available to special order. Extension links are also available for attachment to 2-3/4" (70mm) or 3-3/4" (95mm) backset latchbolts to extend the backset to the desired length.

Desired Backset	Latchbolt Backset	Order Extension List No.
5" (127mm)	2-3/4" (70mm)	481DL
6" (152mm)	3-3/4" (95mm)	481
7" (178mm)	2-3/4" (70mm)	482
8" (203mm)	3-3/4" (95mm)	482
18" (46cm)	2-3/4" (70mm)	484
19" (48cm)	3-3/4" (95mm)	484

Other extension links up to 42" (1.06m) backset are available to special order.

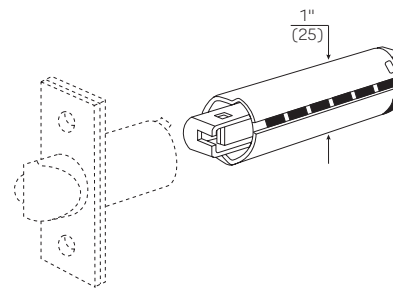

Attaching Screws

(Not regularly supplied when latchbolts ordered separately)

For all latchbolts

- #8-8-32 x 3/4" (19mm) Phillips flat head combination wood and machine screws
- Brass - P/N 81-2022-0416*
- Bronze - P/N 81-2032-0416*

***Specify finish required.**

Hollow Metal Doors

- #8 - 32 x 1" (25mm) Phillips flat head machine screw
- Brass - P/N 81-0022-0420*
- Bronze - P/N 81-0032-0420*

Yale® 5400LN locks are available with a variety of strike options. All strikes are located on the same vertical and horizontal center lines as the latchbolt. Some strikes are available in special lip lengths to accommodate varying thickness of doors and frames. To determine the proper length of the lip, measure from the center line of the strike to the edge of the jamb, accounting for any interfering trim (i.e. wood molding) and then add 1/4" (6mm) for curved lip. All strikes are reversible. Strikes are fabricated of either brass, bronze or stainless steel, depending on the lockset trim finish. When ordering strikes separately, specify the finish required.

<p>Model No. 497 ANSI Strike (Standard) 1-1/4" supplied standard. 1-1/8", 1-1/2", and 1-3/4" lip lengths available by special order. For door and frames with ANSI/BHMA A156.115 preparations.</p>	<p>Model No. 371 T-Strike (Optional) 1-1/4" curved lip supplied standard. 1", 1-1/2", 1-3/4", and 2" curved lip lengths available by special order. Wrought strike box supplied.</p>	<p>Model No. 497B Blank ANSI Strike (Optional) Available to special order. Installed in frame with standard ANSI/BHMA A156.115 preparation to replace the strike when the lockset has been removed from the door.</p>	<p>Model No. 202 Strike Box for ANSI Strike (Optional) Specify 497 x 202</p>

Attaching Screws

(Not regularly supplied when strikes ordered separately).

For Model No. 371 strike

#8-8-32 x 3/4" (19mm) Phillips flat head combination wood and machine screw P/N-81-2012-0416.

For Model No. 497 strike and 497B plate

#12-12-24 x 1" (25mm) Phillips flat head combination wood and machine screw P/N-81-2012-0620.

Note: When ordering strike plates or attaching screws individually, specify the finish required; i.e. 497 x 202 x 612; #81-2012-0620 x 612.

Sample Specification



All locksets shall be 5400LN Series Grade 1 cylindrical lever locksets as assembled by Yale Locks & Hardware.

Lockset chassis shall be constructed of heavy-gauge cold-rolled steel, trivalent chrome plated to protect against rust and corrosion. Locksets shall be adjustable to fit doors between 1-3/4" (44mm) to 2" (51mm) thick.

Locksets shall be non-handed, and shall install easily without the need for specialized installation tools. Locksets shall have separate anti-rotation thrubolts in the 6 o'clock and 12 o'clock position outside the 2-1/8" face bore, and shall have no exposed mounting screws.

Locksets shall have solid one-piece, cast levers without plastic inserts, and shall be a minimum of 5-1/4" in length. Levers shall operate independently, and shall have inside and outside lever return springs. Outside levers on the keyed locksets shall be removable only when the designated key is in the cylinder.

Locksets shall have the capability of accepting 7-pin standard and interchangeable core cylinders to provide expansion capacity for large master keyed systems.

Vandal resistant levers shall be offered as a standard feature in all locking functions, and shall be Free Wheeling in the locked condition. Locksets that are rigid in the locked condition or which must require resetting (breakaway) are not acceptable.

The latchbolt shall be made of stainless steel.

All locksets shall carry a comprehensive seven-year mechanical warranty. Locksets shall carry a lifetime warranty against lever sag or lever spring breakage.

All locksets shall comply with the following certifications:

- UL 3 Hour Fire Rating
- ANSI/BHMA A156.2 Series 4000, Grade 1
- ANSI A117.1 Accessibility Code
- ANSI/BHMA A156.115 or A156.115-W Preparation

Technical Specifications and Listings



ADA

The 5400LN meets accessibility guidelines of the Americans with Disabilities Act and the requirements of the Uniform Federal Accessibility Standards and ANSI 117.1, all requiring ease of accessibility for the handicapped.



ISO 9001

Designed and manufactured under a certified ISO 9001 quality system.

ANSI/BHMA

Certified ANSI/BHMA A156.2, Series 4000 Grade 1.



Knurled Designs

Where required by the local authority, 5400LN trim can be knurled to be identifiable to the touch for blind persons. All lever designs in all finishes may be ordered knurled. Only the outside lever will be knurled unless specified otherwise.

Door Thickness

Adjustable rose support plates allow the 5400LN to easily adjust to doors from 1-3/4" to 2" thick. It can also be used on 1-3/8" thick doors by adding two spacer plates P/N 14-5401-6644. For 2-1/4" thick doors, please specify door thickness on order.

Warranty

The 5400LN Series cylindrical lever lock carries a seven-year warranty. The 5400LN carries a lifetime warranty against lever sag and lever spring breakage.

Fire Listings

UL/cUL Listed for all fire door functions up to 3 hours.

Note: Any retrofit or other field modification to a fire rated opening can potentially impact the fire rating of the opening, and Yale Locks & Hardware makes no representations or warranties concerning what such impact may be in any specific situation. When retrofitting any portion of an existing fire rated opening, or specifying and installing a new fire-rated opening, please consult with a code specialist or local code official (Authority Having Jurisdiction) to ensure compliance with all applicable codes and ratings.



Windstorm

Certified (refer to local codes). 5400LN Series can be provided to meet FEMA 320 standards. See page 4 for How to Order.



Hurricane



Tornado

Installation

5400LN Series Cylindrical Locks conform to ANSI/BHMA Specifications A156.115 which cover hardware preparations for steel doors and steel frames and A156.115-W which cover hardware preparations for wood doors with wood or steel frames.



Trusted every day

Phone

1-855-557-5078

Customer Service Email

customerservice.yale@assaabloy.com

Technical Product Support Email

techsupport.yale@assaabloy.com

Order Entry Email

orders.yaleus@assaabloy.com

Fax

1-800-338-0965

Website

www.yalecommercial.com

Contact Us

U.S.A.

Yale Locks & Hardware

Address: 225 Episcopal Road

Berlin, CT 06037-4004

Tel: 1-800-438-1951

Fax: 1-800-338-0965

yalecommercial.com

Canada:

ASSA ABLOY Door Security Solutions Canada

Address: 160 Four Valley Drive

Vaughan, Ontario L4K 4T9

Tel: 1-800-461-3007

Fax: 1-800-461-8989

assaabloydss.ca

International:

ASSA ABLOY Americas International

Tel: 1-905-821-7775

Fax: 1-905-821-1429

assaabloyai.com

MicroShield®

ASSA ABLOY Group companies offer MicroShield®, an anti-microbial coating for door hardware. MicroShield uses proven silver ion-based technology from Agion®, a leading provider of antimicrobial solutions, to stem the spread of bacteria and other microbes.

MicroShield® is a registered trademark of ASSA ABLOY Access and Egress Hardware Group, Inc.



The Agion antimicrobial is not intended as a substitute for good hygiene. Coated products must still be cleaned to ensure the surfaces will be free of destructive microbes. ASSA ABLOY makes no representations or warranties, express or implied, as to the efficacy of the Agion antimicrobial. A copy of the Agion warranty is available upon request. Agion is a registered trademark of Agion Technologies, Inc., Wakefield, MA, USA.

THE YALE BRAND, with its unparalleled global reach and range of products, reassures more people in more countries than any other consumer locking solution.

THE ASSA ABLOY GROUP is the world's leading manufacturer and supplier of locking solutions, dedicated to satisfying end-user needs for security, safety and convenience.

Yale Commercial is a business associated with ASSA ABLOY Access and Egress Hardware Group, Inc., an ASSA ABLOY Group company. Copyright © 2002-2021, ASSA ABLOY Access and Egress Hardware Group, Inc. All rights reserved. Reproduction in whole or in part without the express written permission of ASSA ABLOY Access and Egress Hardware Group, Inc. is prohibited. Patent pending and/or patent www.assaabloydss.com/patents.



5300LN Series

ANSI/BHMA Grade 2 Certified Cylindrical Lever Locks



Table of Contents



Contents

Benefits & Features.....	3
How to Order.....	4
Finishes.....	5
Lever Trim.....	6
Functions.....	7-9
Electrified Options.....	10
Electrified Accessories.....	11
Cylinders.....	12-13
Latchbolts.....	14
Strikes.....	15
Sample Specification.....	16
Technical Specifications & Listings.....	17

5300LN Series Cylindrical Lever Locks

The 5300LN Series Cylindrical Lever Lock is a reliable Grade 2 cylindrical lockset that boasts innovative design and construction features. The Free Wheeling lever mechanism helps to resist against vandalism, while the adjustable door thickness feature makes for easy installation. Protected by a five year warranty and a lifetime warranty against lever sag and spring breakage, you can rely on the 5300LN to withstand the rigors of everyday use.

With innovative features in an affordable lock, Yale Works for YouSM.



Benefits & Features

Benefits

- **Secure:** Designed to withstand everyday use and resist damage and vandalism
- **Versatile:** Variety of functions, trims, finishes and keying options for ultimate installation flexibility
- **Protected:** Five year mechanical warranty plus a lifetime warranty against lever sag and lever spring breakage
- **Strong & Reliable:** ANSI/BHMA Grade 2 certified for long life and durability

Features

- Free Wheeling lever mechanism prevents vandalism and reduces lock maintenance
- Adjustable door thickness mechanism
- Heavy duty torsion spring prevents lever sag throughout product's lifetime
- Thrubolts solidly through the door, providing greater strength and stability
- Available with a wide range of cylinder options
- Available in 23 functions (including electrified), 12 standard finishes and 3 lever designs
- ADA compliant for ease of accessibility

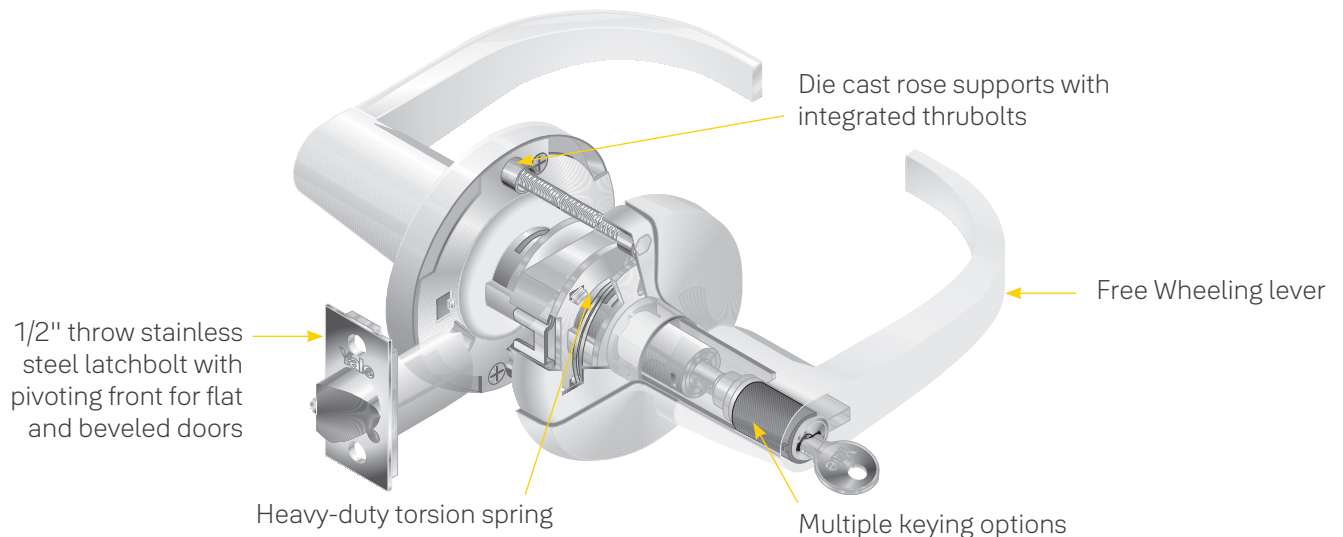

Specifications

Backset	2-3/4" standard, 2-3/8" optional
Door Thickness	Adjustable for doors 1-3/4" to 2"
Handing	Non-handed, field reversible
Latchbolt	2-3/4" backset, 1/2" throw. See page 14 for additional options.
Strike	ANSI strike 4-7/8" x 1-1/4" x 1-1/4" lip to center. See page 15 for additional options.
ANSI/BHMA	Certified Grade 2, ANSI/BHMA A156.2
UL/cUL	Listed for 3 hour fire doors
Windstorm	Certified, check local codes.
Warranty	5 years



How To Order



Trim Design	Function	Latch	Strike	Cylinder	Door Thickness	Finish
AU = Augusta	5301LN	380BN supplied standard for plain latchbolt functions	Model No. 497 ANSI Strike (1-1/4") standard. See page 15 for additional options.	1803-47L standard	Adjustable for doors 1-3/4" to 2". For other door thicknesses, please specify.	605
MO = Monroe	5302LN					606
PB = Pacific Beach	5303LN	380AN supplied standard for deadlocking latchbolt functions				609
	5304LN					612
	5305LN	See page 14 for additional options.				613E
	5306LN					616
	5307LN					619
	5308LN					620
	5309LN					625
	5318LN					626
	5321LN					693
	5322LN					BSP
	5325LN					WSP
	5328LN					See page 5 for finish descriptions.
	5329LN					
	5330LN					
	5339LN					
	355LN					
355LN-D						
	See pages 7-9 for more information.					

Ordering Example

Trim Design	Function	Latch	Strike	Cylinder	Door Thickness	Finish
AU	5307LN	380BN	371	1803-47L	1-3/4"	626

Packing

Each box has a strike, paper template, combination wood and machine screws and easy-to-follow instructions. Cylinder functions supplied with two keys and furnished right hand unless otherwise specified. Ten shelf boxes to a case.

Finishes



ANSI/BHMA Code Finish Description				
605 Bright Brass, Clear Coated	606 Satin Brass, Clear Coated	609 Satin Brass, Blackened, Satin Relieved, Clear Coated	612 Satin Bronze, Clear Coated	613E Dark Oxidized Satin Bronze - equivalent
616 Satin Bronze, Blackened, and Satin Relieved, Clear Coated	619* Satin Nickel Plated, Clear Coated	620 Satin Nickel Plated, Blackened, Satin Relieved, Clear Coated	625 Bright Chrome Plated	626* Satin Chrome Plated
693 Black Painted	BSP Black Suede Powder Coat	WSP White Suede Powder Coat		

Note: Dark Oxidized Satin Bronze, Oil Rubbed (613) and Black Oxidized Bronze, Oil Rubbed (722) finishes are available by Special Product Application Request only. Contact customer service for more information.

*Finish available with MicroShield® antimicrobial coating, additional finishes by special application. Consult factory for availability.

MicroShield coating may vary finish color from architectural standards. MicroShield is not intended as a substitute for traditional infection control programs such as hand hygiene or use of disinfectants. Coated products must still be cleaned to ensure the surfaces will be free of destructive microbes. Yale makes no representations or warranties, express or implied, as to the efficacy of MicroShield.

Lever Trim



Augusta AU

Lever: Cast Zinc
Rose: Wrought Brass

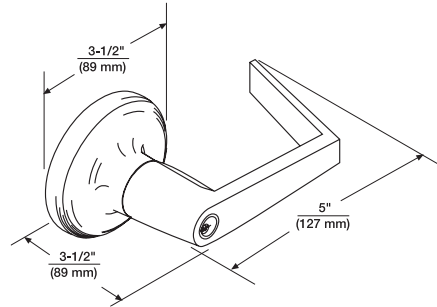

Monroe MO

Lever: Cast Zinc
Rose: Wrought Brass

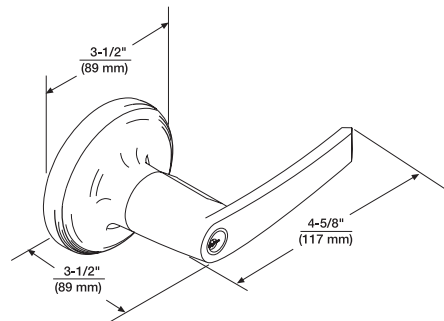

Pacific Beach PB

Lever: Cast Zinc
Rose: Wrought Brass

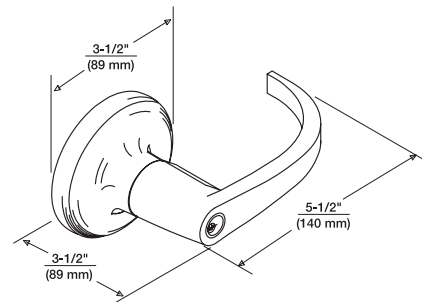

Dimensions are in inches (millimeters).

Available with large and small format interchangeable core. See page 12-13 for details.

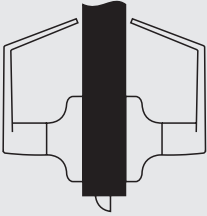
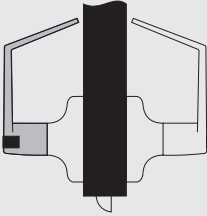
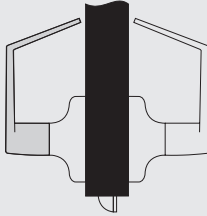
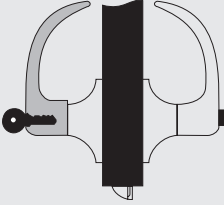
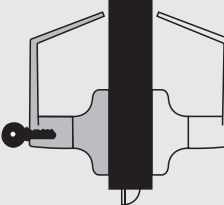
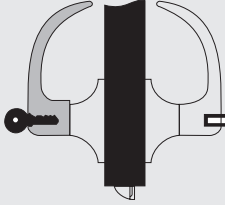

5301LN (F75)	5302LN (F76A)	5303LN (F77A)
<p>Passage or Closet Latch</p> <ul style="list-style-type: none"> • For doors that do not require locking. • Either knob operates latchbolt at all times.  <p style="text-align: center;">Outside Inside</p>	<p>Privacy, Bedroom or Bath Lock</p> <ul style="list-style-type: none"> • For lavatory or other privacy doors. • Either lever operates latchbolt unless outside lever is locked by pushbutton inside.* • Button automatically releases when inside lever is turned or door is closed. • Emergency release in outside lever. Emergency key supplied. (P/N 14-5302-1053-048) • Inside lever always active.  <p style="text-align: center;">Outside Inside</p>	<p>Patio or Privacy Lock</p> <ul style="list-style-type: none"> • For exit doors with limited entry. • Deadlocking latchbolt. • Either lever operates latchbolt unless outside lever is locked by pushbutton inside.* • Button automatically releases when inside lever is turned or door is closed. • Inside lever always active.  <p style="text-align: center;">Outside Inside</p>
5304LN (F82A)	5305LN (F86)	5306LN (F92)
<p>Entry Lock</p> <ul style="list-style-type: none"> • For entrance or office doors. • Deadlocking latchbolt. • Either lever operates latchbolt (except when outside lever is locked from inside).* • Pushing button in inside lever locks outside lever. (Automatically releases when inside lever is turned or key is rotated in locked outside lever.) • Latchbolt is operated by key in outside lever or by rotating inside lever. • Inside lever always active.  <p style="text-align: center;">Outside Inside</p>	<p>Storeroom or Closet Lock</p> <ul style="list-style-type: none"> • For use on storeroom, utility, exit doors. • Deadlocking latchbolt. • Latchbolt operated by lever inside, key in outside lever. • Outside lever always locked.*  <p style="text-align: center;">Outside Inside</p>	<p>Service Station Lock</p> <ul style="list-style-type: none"> • Deadlocking latchbolt. • Either lever operates latchbolt. • Pushbutton in inside lever locks outside lever. (Automatically releases when inside lever is turned, door is closed or key is rotated in outside lever, except when slotted pushbutton is rotated 90° clockwise to retain outside lever in locked position.)* • Latchbolt operated by key in outside lever, inside lever always active.  <p style="text-align: center;">Outside Inside</p>

*Lever handles are Free Wheeling in locked position. Shaded area denotes Free Wheeling lever.

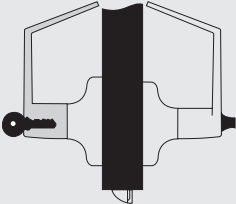
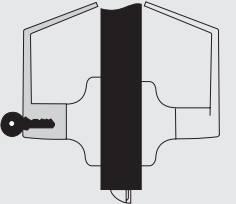
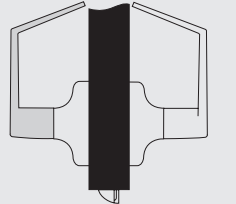
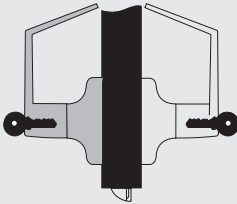
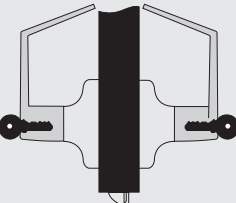
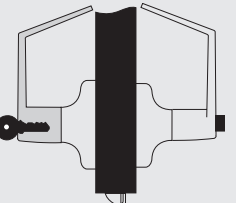
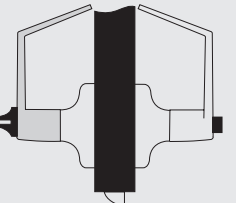
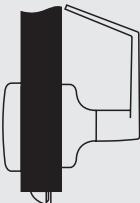

5307LN (F109)	5308LN (F84)	5309LN (F89)	5318LN (F110)
<p>Entry Lock</p> <ul style="list-style-type: none"> • For entrance, general home or office doors. • Deadlocking latchbolt. • Either lever operates latchbolt (except when outside lever is locked from inside).* • Pushing turn button in inside lever locks outside lever. (Automatically releases when inside lever is turned or key is rotated in locked outside lever.) • Outside lever may be retained in locked position by pushing and rotating turn button 90° clockwise to a horizontal position; not released until turn button is manually returned to the vertical position. • Latchbolt is operated by key in outside lever or by rotating inside lever. • Inside lever always active.  <p>Outside Inside</p>	<p>Classroom Lock</p> <ul style="list-style-type: none"> • For classroom or utility room doors. • Deadlocking latchbolt. • Either lever operates latchbolt (except when outside lever is locked by key).* • Inside lever always active. • Key releases outside lever.  <p>Outside Inside</p>	<p>Exit Latch</p> <ul style="list-style-type: none"> • For exit doors with no-entry desired. • Deadlocking latchbolt. • Outside lever always locked.* • Inside lever always active.  <p>Outside Inside</p>	<p>Intruder Classroom Lock</p> <ul style="list-style-type: none"> • For classroom doors. • Deadlocking latchbolt. • Either lever operates latchbolt (except when outside lever is locked by key from either side). • Outside lever remains locked upon egress • Inside lever always active. <p>(NOTE: Not available with I.C. core cylinders.)</p>  <p>Outside Inside</p>
5321LN (F80)	5322LN (F90)	5325LN	5328LN (F111)
<p>Communicating Lock</p> <ul style="list-style-type: none"> • For communicating or store entrance doors. • Deadlocking latchbolt. • Either lever operates latchbolt (except when key in either lever locks or unlocks the lever independently of the other).* • Should be used only in offices or rooms with multiple entries. <p>(NOTE: Not available with I.C. core cylinders.)</p>  <p>Outside Inside</p>	<p>Corridor Lock</p> <ul style="list-style-type: none"> • Deadlocking latchbolt. • Either lever operates latchbolt (except when outside lever is locked by inside push-button or key in outside lever). Inside lever always active. • When locked by button, the button automatically releases when inside lever is turned or door is closed. • When locked by key, the automatic release is made inoperative and must be manually unlocked by key.  <p>Outside Inside</p>	<p>Privacy Lock</p> <ul style="list-style-type: none"> • For lavatory or other privacy doors. • Either lever operates latchbolt (except when outside lever is locked by inside pushbutton).* • Button automatically releases by turning inside lever or closing door. • Door can be unlocked, when necessary, by operating outside turnbutton. • No emergency key required. • Optional flush turnbutton available for outside. Specify option "FTB".  <p>Outside Inside</p>	<p>Communicating Passage Lock</p> <ul style="list-style-type: none"> • For twin communicating or exit doors where one side operation is required. • Also when space is limited between door and switch panel. • Deadlocking latchbolt. • One lever operation. • Blank rose. • Should be used only where rooms have more than one entrance.  <p>Outside Inside</p>

*Lever handles are Free Wheeling in locked position. Shaded area denotes Free Wheeling lever.

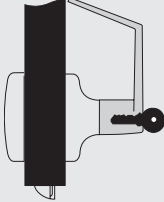
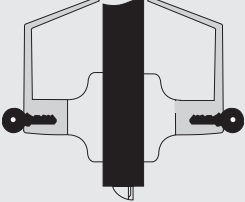
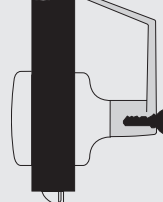
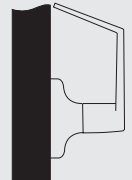
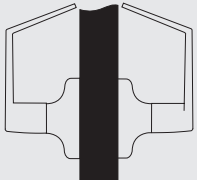
5329LN (F113)	5330LN (F87)	5339LN (F112)
<p>Communicating Classroom Lock</p> <ul style="list-style-type: none"> • For twin communicating or closet doors where one side operation is required or space between doors is limited. • Deadlocking latchbolt. • Inside lever operates latchbolt except when lever is locked by key.* • Blank rose. • Should be used only where rooms have more than one entrance. <p>(Note: Not available with I.C. core cylinders)</p>  <p>Outside Inside</p>	<p>Utility, Asylum or Institutional Lock</p> <ul style="list-style-type: none"> • Deadlocking latchbolt. • Latchbolt operated by key in lever from either side. • Both levers always locked.* <p>(Note: Not available with IC core cylinders)</p>  <p>Outside Inside</p>	<p>Communicating Storeroom Lock</p> <ul style="list-style-type: none"> • For twin communicating or closet doors where one side operation is required or space between doors is limited. • Deadlocking latchbolt. • Latchbolt operated by key only in inside lever. • Inside lever always locked.* • Blank rose. • Should be used only where rooms have more than one entrance. <p>(Note: Not available with I.C. core cylinders)</p>  <p>Outside Inside</p>
<p>355LN</p> <p>Dummy Trim</p> <ul style="list-style-type: none"> • For non-operational levers use for decorative trim.  <p>Outside Inside</p>	<p>355LN-D</p> <p>Double Dummy Trim</p> <ul style="list-style-type: none"> • For non-operational lever used for decorative trim. • Through-bolted.  <p>Outside Inside</p>	

***Lever handles are Free Wheeling in locked position. Shaded area denotes Free Wheeling lever.**

Electrified Options



Operation

Electric locks provide the ability to electrically lock or unlock the outside trim from a remote location. Fail Safe locks are commonly used in stair towers to release upon fire alarm activation. Fail Secure locks are used on perimeter doors or security doors to allow ingress using access control technologies (proximity cards, keypads, etc.)



Features

- Free Wheeling lever mechanism.
- Self-contained, continuous-duty integral solenoid (allows installation in standard cylindrical prep).
- Available Fail Safe or Fail Secure.
- Available in 12 or 24 volts DC.
- 8 position ElectroLynx plug connector
- External rectifier available upon request for AC operation.
- Mechanical cylinder override.
- All 5300LN cylinder options.
- Certified ANSI/BHMA Grade 2. 
- UL listed.
- 1-year limited warranty.

Electrical Specifications

- Continuous duty solenoid
150 mA @ 24VDC
300 mA @ 12VDC



Electrolynx®



Yale® electrified 5300LN locks are equipped with ElectroLynx connectors. As a standard feature, these connectors link power from the incoming source to electrified locking products, including hinges, locks, exit devices, magnetic holders and strikes.

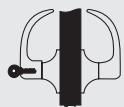

Note: Electrified door hardware with ElectroLynx connectors requires a compatible number of lead wires attached to the door hinge.

Functions

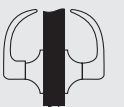
Outside	Inside	Function	Function Description
		5390LN	Fail Safe <ul style="list-style-type: none"> • Power on locks outside lever. • Inside lever always active. • Latchbolt retracted by key when locked electrically. • Free Wheeling lever when locked electrically.
		5391LN	Fail Secure <ul style="list-style-type: none"> • Power on unlocks outside lever. • Inside lever always active. • Latchbolt retracted by key when power is off. • Free Wheeling lever when power is off (locked).

Outside	Inside	Function	Function Description
		5380LN	Fail Safe <ul style="list-style-type: none"> • Power on locks outside lever. • Inside lever always active. • Latchbolt retracted either side except when outside lever is locked electrically. • Free Wheeling lever when locked electrically.
		5381LN	Fail Secure <ul style="list-style-type: none"> • Power on unlocks outside lever. • Inside lever always active. • Latchbolt retracted either side when power is off. • Free Wheeling lever when power is off (locked).

Electrified Accessories



BPS Power Supplies By Securitron®

Operation

Power supplies are designed to provide reliable filtered and regulated power for long life to a variety of electrified hardware components.

Product Features

- Individual output circuit breakers
- Regulated and filtered fuse protected outputs
- LEDs monitor zone status (voltage or no voltage)
- Slide switches connect or disconnect load from power (Not available on 1 Amp supplies)
- Internal Back-Up battery charging circuit
- Rugged steel enclosure
- Fire alarm interface

Listings

- UL CLASS 2

Applications (use with):

- Fail Safe cylindrical locks
- Fail Secure cylindrical locks

Ordering

Ex: BPS-24-4, BPS-12-3

Model	Input	Output	Application*
BPS-24-1	120 VAC	1 Amp @ 24 VDC	2-5300LN
BPS-24-2	120 VAC	2 Amp @ 24 VDC	5-5300LN
BPS-24-4	120 VAC	4 Amp @ 24 VDC	11-5300LN
BPS-12-1	120 VAC	1 Amp @ 12 VDC	1-5300LN
BPS-12-3	120 VAC	2 Amp @ 12 VDC	3-5300LN

Consult factory for additional power supply applications.

*Numeric prefix denotes how many locks can be wired to each power supply.

Yale recommends McKinney®, Pemko and Securitron® for power transfer devices and other electronic accessories.



Cylinder Options

The Following Selection Guide Indicates The Correct Cylinder For Each Locking Segment.

Lockset Series: 5300LN		Types of Cylinder Mechanisms					
		Conventional		Protected Keyway		Security	
Cylinder Types	Fixed Core	6-pin	7-pin	6-pin	7-pin	6-pin	7-pin
	Key-In-Lever	1803-47L ¹	N/A	K402 ²	N/A	5803-47L ¹	N/A
	Interchangeable Core						
	LFIC	1210	N/A	K800	N/A	5210	N/A
SFIC	A600	A600	K600	K600	N/A	N/A	

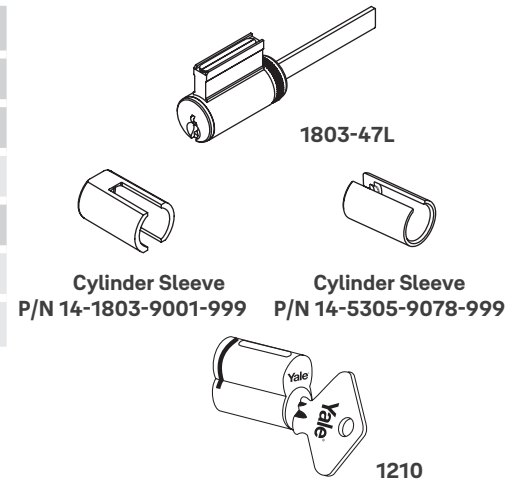

Refer to Yale® KeyMark® and/or Cylinders and Keys Catalog sections for all details and how-to-order examples.

1. Cylinders require cylinder sleeve P/N 14-1803-9001-999
2. Cylinder requires cylinder sleeve P/N 14-5305-9078-999

Yale® KeyMark®

For those applications requiring protected key control, Yale® KeyMark® cylinders guard against unauthorized key duplication. The Yale KeyMark Security Leg® keyway feature increases resistance against picking and impressioning and can easily retrofit into existing systems. For further details and availability, refer to the separate Yale KeyMark catalog.

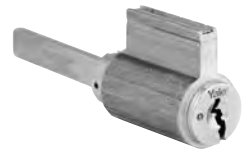

Security Cylinders

Security cylinders contain two independent locking mechanisms. The first is a traditional 6-pin tumbler mechanism with spool drivers for greatly increased picking resistance.

The second is an innovative 5-tumbler rotating disc mechanism with sidebar engagement. The rotating discs are spring loaded and block the bottom of the keyway.

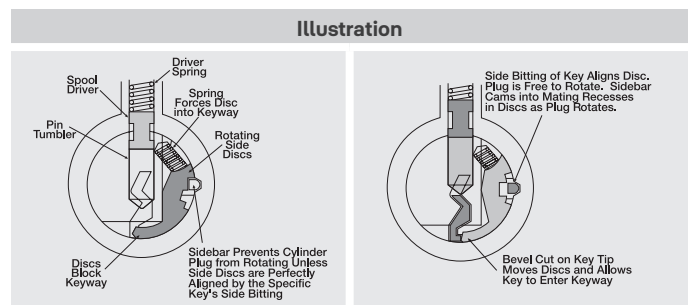

Cylinders



108S / 108L* Schlage® Cylinder Adapter Kit

Kit used to modify Schlage® cylinder for fit in the 5300LN.

P/N 14-5305-0090-048 - 108S

P/N 14-5305-9078-999 - 108L*

Kit includes tailpiece and sleeve. To order the 108S adapter kit, use an "S" prefix (i.e., S-AU5307LN).

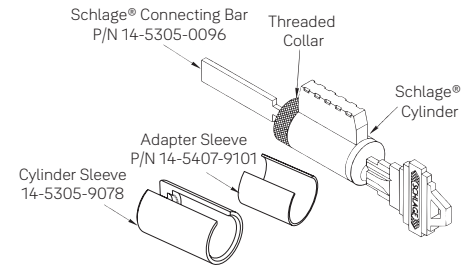

* 2", 2-1/4" door.

Other Manufacturer Keyway Cylinders

Illustration	Description	Model Number	Number of Pins
	Best® Keyway Cylinder. Available keyed random, master keyed or uncombined. Specify keyway A, B, C, D, E, F, G, H, J, K, L or M.	A600	6 or 7
	Schlage® "C" Keyway. Available O-bitted or keyed random.	2803-47L	6
	Corbin Russwin "L4", Corbin "60", Russwin "D1", Sargent® "LA" or Schlage® "E" Keyway. Specify keyway. Available keyed random.	3803-47L	6

The 2803 and 3803 cylinders require a cylinder sleeve (P/N 14-1803-9001-999) to fit the 5300LN lockset.

Levers Accepting SFIC And Other Manufacturers' Large Format Interchangeable Cores

Illustration	Description	Prefix	Number of Pins
	SFIC (Accepts all Small Format Interchangeable Cores)	B (i.e. B-AU, B-MO, B-PB)	6 or 7
	Medeco®, ASSA® (LFIC)	M (i.e. M-AU)**	6
	Schlage® (LFIC)	SI (i.e. SI-AU, SI-PB)	6

**Medeco®, ASSA® option available only with AU lever. (Note: For Medeco 32 series cores.)

LFIC = Large Format Interchangeable Core

SFIC = Small Format Interchangeable Core

Latchbolts



Plain Latchbolts

Model No. 380BN supplied standard with all 5300LN series locksets without locking function. Model No. 380BN latchbolt has a 2-1/4" x 1-1/8" front with a 2-3/4" backset and a 1/2" bolt throw. Optional latchbolts with greater backset available to special order.

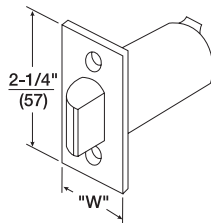

Model No.	Front	Backset	"W" Front Width	Throw	Latch Diameter*
378N	Universal	2-3/8" (60mm)	1" (25mm)	1/2" (13mm)	7/8" (22mm)
380DN	Universal	2-3/4" (70mm)	1" (25mm)	1/2" (13mm)	7/8" (22mm)
3380DN	Universal	3-3/4" (95mm)	1" (25mm)	1/2" (13mm)	7/8" (22mm)
380BN	Universal	2-3/4" (70mm)	1-1/8" (29mm)	1/2" (13mm)	7/8" (22mm)
3380BN	Universal	3-3/4" (95mm)	1-1/8" (29mm)	1/2" (13mm)	7/8" (22mm)

***1/8" sleeve (P/N 14-0378-9001) supplied with all latchbolts to accommodate 1" preps.**

Deadlocking Latchbolts

Model No. 380AN supplied standard with all 5300LN series locksets with locking function. Model No. 380AN latchbolt has a 2-1/4" x 1-1/8" front with a 2-3/4" backset and a 1/2" bolt throw. Optional latchbolts with greater backset available to special order.

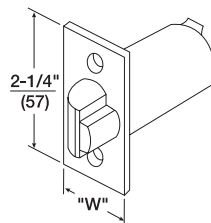

Model No.	Front	Backset	"W" Front Width	Throw	Latch Diameter*
380N	Universal	2-3/8" (60mm)	1" (25mm)	1/2" (13mm)	7/8" (22mm)
380CN	Universal	2-3/4" (70mm)	1" (25mm)	1/2" (13mm)	7/8" (22mm)
3380CN	Universal	3-3/4" (95mm)	1" (25mm)	1/2" (13mm)	7/8" (22mm)
380AN	Universal	2-3/4" (70mm)	1-1/8" (29mm)	1/2" (13mm)	7/8" (22mm)
3380AN	Universal	3-3/4" (95mm)	1-1/8" (29mm)	1/2" (13mm)	7/8" (22mm)

***1/8" sleeve (P/N 14-0378-9001) supplied with all latchbolts to accommodate 1" preps.**

Backset Extension Links

All 5300LN Series locksets are regularly supplied with latchbolts with a 2-3/4" backset. Latchbolts with 2-3/8" and 3-3/4" backsets are available to special order. Backset extension links are also available for attachment to latchbolts with 2-3/8" backsets or to latchbolts with 2-3/4" and 3-3/4" backsets to obtain popular backset lengths.

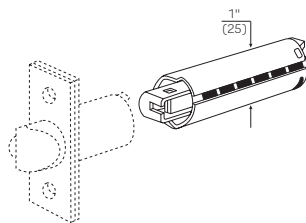

Backset Desired	Latchbolt Backset	Order Extension Model Number
5"	2-3/8"	381N
5"	2-3/4"	381AN
6"	3-3/4"	381AN

Attaching Screws

(Not regularly supplied when latchbolts ordered separately).

For All Latchbolts

#8-8-32 x 3/4" Phillips flat head combination wood and machine screws. P/N 81-2012-0416

All latches have universal fronts, so they fit flat and beveled door fronts. When ordering latchbolts, specify Model No. x Finish (e.g., 380N x 626).



Strikes

Yale® 5300LN locks are available with a variety of strike options. All strikes are located on the same vertical and horizontal center lines as the latchbolt. Some strikes are available in a variety of lip lengths to accommodate varying thickness of doors and frames. To determine the proper length of the lip, measure from the center line of the strike to the edge of the jamb, accounting for any interfering trim (i.e. wood molding) and then add 1/4" (6mm) for curved lip. All strikes are reversible. Strikes are fabricated of either brass, bronze or stainless steel, depending on the lockset trim finish. When ordering strikes separately, specify the finish required.

Model No. 497 ANSI Strike (Standard)
For door and frames with ANSI/BHMA A156.115 preparations. 1-1/4" supplied standard. 1-1/8", 1-1/2", and 1-3/4" lip lengths available by special order.

Model No. 371 T-Strike (Optional)
1-1/4" curved lip supplied standard. 1", 1-1/2", 1-3/4", and 2" curved lip lengths available by special order. Wrought strike box supplied.

Model No. 497B Blank ANSI Strike (Optional)
Available to special order. Installed in frame with standard ANSI/BHMA A156.115 preparation to replace the strike when the lockset has been removed from the door.

Model No. 70S Full Lip Strike (Optional)
With full lip anti-rattle tab. Wrought strike box supplied.

Model No. 71S Full Lip Strike (Optional)
1/4" radius. Similar in dimensions and function to the 70S Strike but with radius corners for easy mortising by power tools. Anti-rattle tab. Wrought strike box supplied.

Model No. 202 Strike Box for ANSI Strike (Optional)
Specify 497 x 202

Attaching Screws

(Not regularly supplied when strikes ordered separately).

For Model Nos. 371, 70S, and 71S

#8-8-32 x 3/4" (19mm) Phillips flat head combination wood and machine screws.

P/N 81-2012-0416

For Model Nos. 497 and 497B

#12-12-24 x 1" Phillips flat head combination wood and machine screws.

P/N 81-2012-0620

NOTE: When ordering strike or attaching screws individually, specify the finish required; i.e. 497 x 202 x 606; 81-2012-0620 x 606.

Sample Specification



All locksets shall be 5300LN Series Grade 2 Key-in-Lever Cylindrical Locksets as assembled by Yale Locks & Hardware.

Lockset chassis shall be constructed of heavy-gauge steel and cast components, plated to protect against rust and corrosion. Locksets shall be adjustable for 1-3/8" (35mm) and 1-3/4" (44mm) or 2" (51mm) and 2-1/4" (57mm) door thickness.

Locksets shall be non-handed, and shall install easily without the need for specialized installation tools.

Locksets shall have separate anti-rotation through-bolts in the 6 o'clock and 12 o'clock position outside the 2-1/8" face bore, and shall have no exposed mounting screws.

Locksets shall have solid one-piece, cast levers without plastic inserts, and shall be a minimum of 4-5/8" (117mm) in length. Levers shall operate independently and shall have inside and outside lever return springs. Outside levers on the keyed locksets shall be removable only when the designated key is in the cylinder. Vandal-resistant levers shall be offered as a standard feature in all locking functions and shall be Free Wheeling in the locked condition. Locksets that are rigid in the locked condition, or which require resetting (breakaway) are not acceptable.

The latchbolt shall be made of stainless steel.

All locksets shall carry a five-year mechanical warranty. Locksets shall carry a lifetime warranty against lever sag or lever spring breakage.

All locksets shall comply with the following certifications:

- UL 3-Hour Fire Rating
- ANSI/BHMA A156.2 Series 4000, Grade 2
- ANSI A117.1 Accessibility Code
- ANSI/BHMA A156.115 or A156.115-W Preparation



Technical Specifications and Listings

ADA

The 5300LN meets accessibility guidelines of the Americans with Disabilities Act and the requirements of the Uniform Federal Accessibility Standards and ANSI 117.1, all requiring ease of accessibility.



ISO 9001

Designed and manufactured under a certified ISO 9001 quality system.

ANSI/BHMA

Certified ANSI/BHMA A156.2, Series 4000 Grade 2.



Knurled Designs

Where required by the local authority, 5300LN trim can be knurled to be identifiable to the touch for blind persons. All lever designs in all finishes may be ordered knurled. Only the outside lever will be knurled unless specified otherwise.

Door Thickness

Adjustable rose support plates allow the 5300LN to easily adjust to doors from 1-3/4" to 2" thick. It can also be used on 1-3/8" thick doors by adding two spacer plates P/N 14-5401-6644. For 2-1/4" thick doors, please specify door thickness on order.

Warranty

The 5300LN Series cylindrical lever lock carries a five-year warranty and a lifetime warranty against lever sag and lever spring breakage.

Fire Listings

All functions are UL/cUL rated for use on fire doors having a rating up to and including 3 hours.

Note: Any retrofit or other field modification to a fire rated opening can potentially impact the fire rating of the opening, and Yale Locks & Hardware makes no representations or warranties concerning what such impact may be in any specific situation. When retrofitting any portion of an existing fire rated opening, or specifying and installing a new fire-rated opening, please consult with a code specialist or local code official (Authority Having Jurisdiction) to ensure compliance with all applicable codes and ratings.

Windstorm

Certified (refer to local codes).

Installation

5300LN Series cylindrical locks conform to ANSI/BHMA Specifications A156.115 which cover hardware preparations for steel doors and steel frames and A156.115-W which cover hardware preparations for wood doors with wood or steel frames.



Trusted every day

Phone

1-855-557-5078

Customer Service Email

customerservice.yale@assaabloy.com

Technical Product Support Email

techsupport.yale@assaabloy.com

Order Entry Email

orders.yaleus@assaabloy.com

Fax

1-800-338-0965

Website

www.yalecommercial.com

Contact Us

U.S.A.

Yale Locks & Hardware

Address: 225 Episcopal Road

Berlin, CT 06037-4004

Tel: 1-800-438-1951

Fax: 1-800-338-0965

yalecommercial.com

Canada:

ASSA ABLOY Door Security Solutions Canada

Address: 160 Four Valley Drive

Vaughan, Ontario L4K 4T9

Tel: 1-800-461-3007

Fax: 1-800-461-8989

assaabloydss.ca

International:

ASSA ABLOY Americas International

Tel: 1-905-821-7775

Fax: 1-905-821-1429

assaabloyai.com

MicroShield®

ASSA ABLOY Group companies offer MicroShield®, an anti-microbial coating for door hardware. MicroShield uses proven silver ion-based technology from Agion®, a leading provider of antimicrobial solutions, to stem the spread of bacteria and other microbes.

MicroShield® is a registered trademark of ASSA ABLOY Access and Egress Hardware Group, Inc.



The Agion antimicrobial is not intended as a substitute for good hygiene. Coated products must still be cleaned to ensure the surfaces will be free of destructive microbes. ASSA ABLOY makes no representations or warranties, express or implied, as to the efficacy of the Agion antimicrobial. A copy of the Agion warranty is available upon request. Agion is a registered trademark of Agion Technologies, Inc., Wakefield, MA, USA.

THE YALE BRAND, with its unparalleled global reach and range of products, reassures more people in more countries than any other consumer locking solution.

THE ASSA ABLOY GROUP is the world's leading manufacturer and supplier of locking solutions, dedicated to satisfying end-user needs for security, safety and convenience.

Yale Commercial is a business associated with ASSA ABLOY Access and Egress Hardware Group, Inc., an ASSA ABLOY Group company. Copyright © 1999-2021, ASSA ABLOY Access and Egress Hardware Group, Inc. All rights reserved. Reproduction in whole or in part without the express written permission of ASSA ABLOY Access and Egress Hardware Group, Inc. is prohibited. Patent pending and/or patent www.assaabloydss.com/patents.



4700LN Series

ANSI/BHMA Grade 1 Certified
Cylindrical Lever Locks



An ASSA ABLOY Group brand

ASSA ABLOY



Table of Contents

CONTENTS

Features3
 Finishes & How To Order4
 Lever Trim5
 Functions 6-8
 Electrified Options9
 Electrified Accessories.....10
 Cylinders11
 Cylinders/Keying.....12
 Latchbolts13
 Strikes14

4700LN SERIES CYLINDRICAL LEVER LOCKS

Yale® 4700LN cylindrical locks are the ideal choice for a wide variety of commercial applications where consistent quality, ease of use and installation are required at an economical price. The 4700LN Series is certified to ANSI/BHMA Grade 1 standards and is UL fire-listed for all functions ensuring reliability and peace of mind.



Features

FEATURES

- Available in 19 functions, 3 lever designs, and 9 finishes
- Knurled lever designs available
- Freewheeling trim
- Available with Microshield® antimicrobial coating



SPECIFICATIONS

Door Thickness:	1-3/4" (44mm) to 2" (51mm); 1-3/8" (35mm) or 2-1/4" (57mm), please specify on order
Strike:	ANSI 4-7/8" x 1-1/4" x 1-1/4" (124mm x 32mm x 32mm) lip to center. See page 14 for optional strikes.
Backset:	2-3/4" (70mm)
Handing:	Non-handed
Installation:	ANSI/BHMA A156.115(-W)
ANSI/BHMA:	Certified ANSI/BHMA A156.2, Series 4000 Grade 1
Warranty:	5 year

APPLICATIONS AND LISTINGS









- UL – cUL listed for use on fire doors having a rating up to and including 3 hours
- Windstorm certified refer to local codes  Hurricane
- Meets accessibility guidelines for the Americans with Disabilities Act and the requirements of the Uniform Federal Accessibility Standards and ANSI 117.1

Note: Any retrofit or other field modification to a fire-rated opening can potentially impact the fire-rating of the opening, and Yale Locks & Hardware makes no representations or warranties concerning what such impact may be in any specific situation. When retrofitting any portion of an existing fire rated opening, or specifying and installing a new fire-rated opening, please consult with a code specialist or local code official (Authority Having Jurisdiction) to ensure compliance with all applicable codes and ratings.





Finishes

ANSI/BHMA Code Finish Description			
605 Bright Brass, Clear Coated 	606¹ Satin Brass, Clear Coated 	612 Satin Bronze, Clear Coated 	613E Dark Oxidized Satin Bronze - equivalent 
625 Bright Chrome Plated 	626^{1,2} Satin Chrome Plated 	BSP Black Suede Powder Coat 	WSP White Suede Powder Coat 

- 1. Cylinders provided in these finishes only.
- 2. Available with MicroShield®.

Note: Dark Oxidized Satin Bronze, Oil Rubbed (613) and Black Oxidized Bronze, Oil Rubbed (722) finishes are available by Special Product Application Request only. Contact customer service for more information.



MicroShield®

As part of their promise to provide innovative solutions to their customers, certain ASSA ABLOY Group brands offer the MicroShield® technology, a silver-based antimicrobial coating designed to inhibit the growth of bacteria.

MicroShield® is a registered trademark of Yale Security Inc., an ASSA ABLOY Group company.

HOW TO ORDER

Trim Design	Function	Hand	Latch	Strike	Cylinder	Door Thickness	Finish
See page 8	See pages 5-7	See page 3	See page 13	See page 14	See pages 11-12	See page 3	See page 4

ORDERING EXAMPLE

Trim Design	Function	Hand	Latch	Strike	Cylinder	Door Thickness	Finish
AU	4707LN	RH	694	497	1803-47L	1-3/4"	626

Lever Trim

AUGUSTA AU

Lever: Cast Zinc
Rose: Wrought Brass

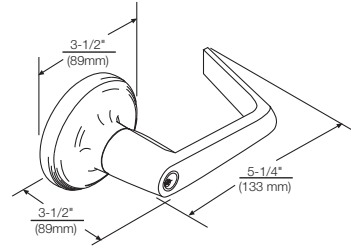

MONROE MO

Lever: Cast Zinc
Rose: Wrought Brass

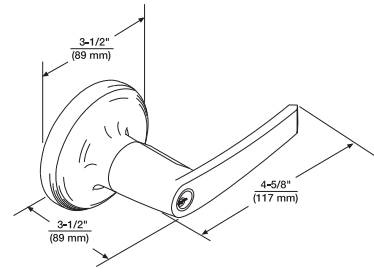

PACIFIC BEACH PB

Lever: Cast Zinc
Rose: Wrought Brass

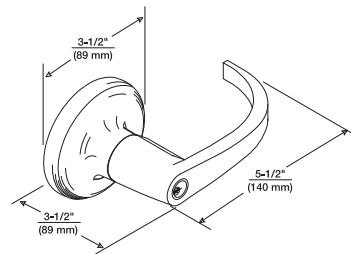

Available with large and small format interchangeable core. See page 11-12 for details.

Dimensions shown are in inches (mm).

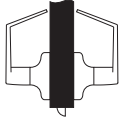
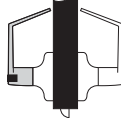
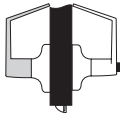
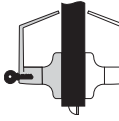
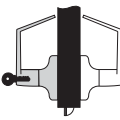
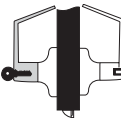
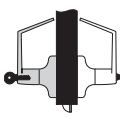
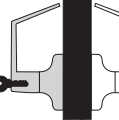

Functions

<p>4701LN (F75)</p> <p>Passage or Closet Latch</p> <ul style="list-style-type: none"> • For doors that do not require locking. • Either lever operates latchbolt at all times.  <p>Outside Inside</p>	<p>4702LN (F76A)</p> <p>Privacy, Bedroom or Bath Lock</p> <ul style="list-style-type: none"> • For lavatory or other privacy doors. • Either lever operates latchbolt unless outside lever is locked by pushbutton inside.* • Button automatically releases when inside lever is turned or door is closed. • Emergency key inserted and turned in hole in outside lever will unlock door from outside. (Emergency key furnished with lockset. P/N 14-5302-1053-048) • Inside lever always active.  <p>Outside Inside</p>	<p>4703LN (F77A)</p> <p>Patio or Privacy Lock</p> <ul style="list-style-type: none"> • For exit doors with limited entry. • Deadlocking latchbolt. • Either lever operates latchbolt unless outside lever is locked by pushbutton inside.* • Button automatically releases when inside lever is turned or door is closed. • Inside lever always active.  <p>Outside Inside</p>	<p>4704LN (F82A)</p> <p>Entry Lock</p> <ul style="list-style-type: none"> • For entrance or office doors. • Deadlocking latchbolt. • Either lever operates latchbolt (except when outside lever is locked from inside).* • Pushing button in inside lever locks outside lever. (Automatically releases when inside lever is turned or key is rotated in locked outside lever.) • Latchbolt is operated by key in outside lever or by rotating inside lever. • Inside lever always active.  <p>Outside Inside</p>
<p>4705LN (F86)</p> <p>Storeroom or Closet Lock</p> <ul style="list-style-type: none"> • For use on storeroom, utility, exit doors. • Deadlocking latchbolt. • Latchbolt operated by lever inside, key in outside lever. • Outside lever always locked.* • Inside lever always active.  <p>Outside Inside</p>	<p>4706LN (F92)</p> <p>Service Station Lock</p> <ul style="list-style-type: none"> • Deadlocking latchbolt. • Either lever operates latchbolt. • Pushbutton in inside lever locks outside lever. (Automatically releases when inside lever is turned, door is closed or key is rotated in outside lever, except when slotted pushbutton is rotated 90° clockwise to retain outside lever in locked position.)* • Latchbolt operated by key in outside lever, inside lever always active.  <p>Outside Inside</p>	<p>4707LN (F109)</p> <p>Entry Lock</p> <ul style="list-style-type: none"> • For entrance, general home or office doors. • Deadlocking latchbolt. • Either lever operates latchbolt (except when outside lever is locked from inside).* • Pushing turn button in inside lever locks outside lever. (Automatically releases when inside lever is turned or key is rotated in locked outside lever.) • Outside lever may be retained in locked position by pushing and rotating turn button 90° clockwise to a horizontal position; not released until turn button is manually returned to the vertical position. • Latchbolt is operated by key in outside lever or by rotating inside lever. • Inside lever always active.  <p>Outside Inside</p>	<p>4708LN (F84)</p> <p>Classroom Lock</p> <ul style="list-style-type: none"> • For classroom or utility room doors. • Deadlocking latchbolt. • Either lever operates latchbolt (except when outside lever is locked by key).* • Inside lever always active. • Key releases outside lever.  <p>Outside Inside</p>

* Lever handles are Free-Whirling in locked position. Shaded area denotes FreeWhirling lever.

Functions

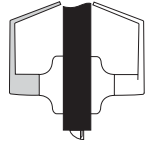
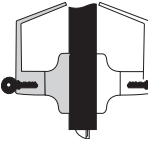
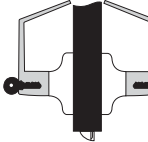
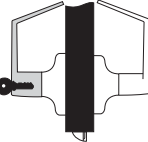
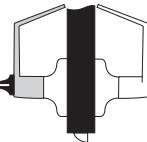
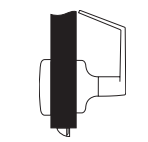
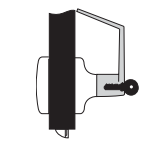
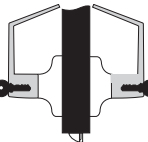
<p>4709LN (F89)</p> <p>Exit Latch</p> <ul style="list-style-type: none"> For exit doors with no-entry desired. Deadlocking latchbolt. Outside lever always locked.* Inside lever always active.  <p>Outside Inside</p>	<p>4718LN (F110)</p> <p>Intruder Classroom Lock</p> <ul style="list-style-type: none"> For classroom doors. Deadlocking latchbolt. Either lever operates latchbolt (except when outside lever is locked by key from either side). Outside lever remains locked upon egress Inside lever always active. <p>(NOTE: Not available with I.C. core cylinders.)</p>  <p>Outside Inside</p>	<p>4721LN (F80)</p> <p>Communicating Lock</p> <ul style="list-style-type: none"> For communicating or store entrance doors. Deadlocking latchbolt. Either lever operates latchbolt (except when key in either lever locks or unlocks the lever independently of the other).* Should be used only in offices or rooms with multiple entries. <p>(NOTE: Not available with I.C. core cylinders.)</p>  <p>Outside Inside</p>	<p>4722LN (F90)</p> <p>Corridor Lock</p> <ul style="list-style-type: none"> Deadlocking latchbolt. Either lever operates latchbolt (except when outside lever is locked by inside push-button or key in outside lever). Inside lever always active. When locked by button, the button automatically releases when inside lever is turned or door is closed. When locked by key, the automatic release is made inoperative and must be manually unlocked by key.  <p>Outside Inside</p>
<p>4725LN</p> <p>Privacy Lock</p> <ul style="list-style-type: none"> For lavatory or other privacy doors. Either lever operates latchbolt (except when outside lever is locked by inside pushbutton).* Button automatically releases by turning inside lever or closing door. Door can be unlocked, when necessary, by operating outside turnbutton. No emergency key required. Optional flush turnbutton available for outside. Specify option "FTB".  <p>Outside Inside</p>	<p>4728LN (F111)</p> <p>Communicating Passage Lock</p> <ul style="list-style-type: none"> For twin communicating or exit doors where one side operation is required. Also when space is limited between door and switch panel. Deadlocking latchbolt. One lever operation. Blank rose. Should be used only where rooms have more than one entrance.  <p>Outside Inside</p>	<p>4729LN (F113)</p> <p>Communicating Classroom Lock</p> <ul style="list-style-type: none"> For twin communicating or closet doors where one side operation is required or space between doors is limited. Deadlocking latchbolt. Inside lever operates latchbolt except when lever is locked by key.* Blank rose. Should be used only where rooms have more than one entrance. <p>(NOTE: Not available with I.C. core cylinders)</p>  <p>Outside Inside</p>	<p>4730LN</p> <p>Utility, Asylum or Institutional Lock</p> <ul style="list-style-type: none"> Deadlocking latchbolt. Latchbolt operated by key in lever from either side. Both levers always locked.* <p>Note: Not available with IC core cylinders.</p>  <p>Outside Inside</p>

* Lever handles are Free-Wheeling in locked position. Shaded area denotes FreeWheeling lever.



Functions

4739LN (F112)

Communicating Storeroom Lock

- For twin communicating or closet doors where one side operation is required or space between doors is limited.
- Deadlocking latchbolt.
- Latchbolt operated by key only in inside lever.
- Inside lever always locked.*
- Blank rose.
- Should be used only where rooms have more than one entrance.

(Note: Not available with I.C. core cylinders)

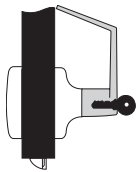

Outside Inside

4755LN

Single Dummy Trim

- For non-operational levers used for decorative trim.
- Rigid lever.



Outside Inside

4755LN-D

Double Dummy Trim

- For non-operational lever used for decorative trim.
- Through-bolted.

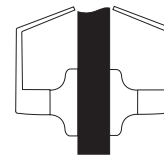

Outside Inside

* Lever handles are Free-Wheeling in locked position. Shaded area denotes FreeWheeling lever.



Electrified Options

OPERATION

Electric locks provide the ability to electrically lock or unlock the outside trim from a remote location. Fail Safe locks are commonly used in stair towers to release upon fire alarm activation. Fail Secure locks are used on perimeter doors or security doors to allow ingress using access control technologies (proximity cards, keypads, etc.)



FEATURES

- Free Wheeling lever mechanism.
- Self-contained, continuous-duty integral solenoid (allows installation in standard cylindrical prep).
- Available Fail Safe or Fail Secure.
- Available in 12 or 24 volts DC.
- External rectifier available upon request for AC operation.
- Mechanical cylinder override.
- All 4700LN cylinder options.
- Certified ANSI/BHMA Grade 1. 
- UL listed.
- 1-year limited warranty.

ELECTRICAL SPECIFICATIONS

- Continuous duty solenoid
150 mA @ 24VDC
300 mA @ 12VDC

ELECTROLYNX®

Yale® electrified 4700LN locks are equipped with ElectroLynx connectors. As a standard feature, these connectors link power from the incoming source to electrified locking products, including hinges, locks, exit devices, magnetic holders and strikes.

Note: Electrified door hardware with *ElectroLynx* connectors requires a compatible number of lead wires attached to the door hinge.

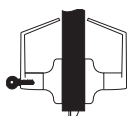
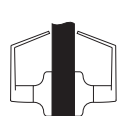
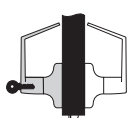
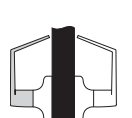

FUNCTIONS

Outside	Inside	Function	Function Description	Outside	Inside	Function	Function Description
		4790LN	Fail Safe <ul style="list-style-type: none"> • Power on locks outside lever. • Inside lever always active. • Latchbolt retracted by key when locked electrically. • Free Wheeling lever when locked electrically. 			4780LN	Fail Safe <ul style="list-style-type: none"> • Power on locks outside lever. • Inside lever always active. • Latchbolt retracted either side except when outside lever is locked electrically. • Free Wheeling lever when locked electrically.
		4791LN	Fail Secure <ul style="list-style-type: none"> • Power on unlocks outside lever. • Inside lever always active. • Latchbolt retracted by key when power is off. • Free Wheeling lever when power is off (locked). 			4781LN	Fail Secure <ul style="list-style-type: none"> • Power on unlocks outside lever. • Inside lever always active. • Latchbolt retracted either side when power is off. • Free Wheeling lever when power is off (locked).



Electrified Options

BPS POWER SUPPLIES BY SECURITRON®

Operation

Power supplies are designed to provide reliable filtered and regulated power for long life to a variety of electrified hardware components.

Product Features

- Individual output circuit breakers
- Regulated and filtered fuse protected outputs
- LEDs monitor zone status (voltage or no voltage)
- Slide switches connect or disconnect load from power (Not available on 1 Amp supplies)
- Internal Back-Up battery charging circuit
- Rugged steel enclosure
- Fire alarm interface

Listings

- UL CLASS 2

Applications (use with):

- Fail Safe cylindrical locks
- Fail Secure cylindrical locks

Ordering

Ex: BPS-24-4, BPS-12-3

Model	Input	Output	Application
BPS-24-1	120 VAC	1 Amp @ 24 VDC	2-4700LN
BPS-24-2	120 VAC	2 Amp @ 24 VDC	5-4700LN
BPS-24-4	120 VAC	4 Amp @ 24 VDC	11-4700LN
BPS-12-1	120 VAC	1 Amp @ 12 VDC	1-4700LN
BPS-12-3	120 VAC	2 Amp @ 12 VDC	3-4700LN

Consult factory for additional power supply applications.

Yale recommends McKinney®, Pemko and Securitron® for power transfer devices and other electronic accessories.

SECURITRON POWERJUMP™ ICPT

The Securitron PowerJump ICPT Inductive Coupling Power Transfer delivers power contactlessly and invisibly between the frame and door to power electrified hardware on the door. The PowerJump can be installed at the latch side or hinge side of the door and transfers up to 6 watts of power without pins or wires across the door gap, eliminating points of vulnerability and wear ... and no need to core drill the door. The PowerJump is field selectable for 12VDC or 24VDC systems and is ideal for fail secure applications. The unit can hold electrified latches open in continuous duty or can momentarily energize the lockset for latch retraction.



Additional information regarding this product can be found at www.securitron.com.



Cylinders

CYLINDER OPTIONS

The following selection guide indicates the correct cylinder for each locking segment.

Lockset Series:	Types of Cylinder Mechanisms						
	4700LN	Conventional		Protected Keyway		Security	
Cylinder Types	Fixed Core	6-pin	7-pin	6-pin	7-pin	6-pin	7-pin
Key-In-Lever	1803-47L ¹	N/A	K402 ²	N/A	5803-47L ¹	N/A	
Interchangeable Core							
LFIC	1210	N/A	K800	N/A	5210	N/A	
SFIC	A600	A600	K600	K600	N/A	N/A	

Refer to Yale® KeyMark® and/or Cylinders and Keys Catalog sections for all details and how-to-order examples.

1. Cylinders require cylinder sleeve P/N 14-1803-9001-999
2. Cylinder requires cylinder sleeve P/N 14-5305-9078-999

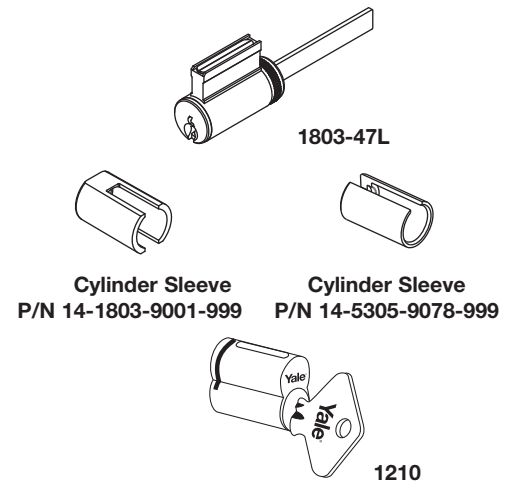

YALE® KEYMARK®

For those applications requiring protected key control, Yale® KeyMark® cylinders guard against unauthorized key duplication. The Yale KeyMark Security Leg® keyway feature increases resistance against picking and impressioning and can easily retrofit into existing systems. For further details and availability, refer to the separate Yale KeyMark catalog.

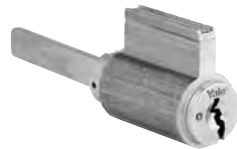

SECURITY CYLINDERS

Security cylinders contain two independent locking mechanisms. The first is a traditional 6-pin tumbler mechanism with spool drivers for greatly increased picking resistance.

The second is an innovative 5-tumbler rotating disc mechanism with sidebar engagement. The rotating discs are spring loaded and block the bottom of the keyway.

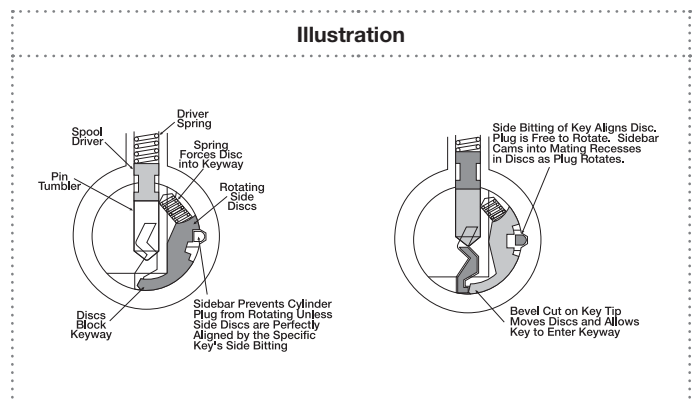

108S SCHLAGE® CYLINDER ADAPTER KIT

Kit used to modify Schlage® cylinder for fit in the 4700LN.

P/N 14-5305-0090-048 - 108S

Kit includes tailpiece and sleeve. To order the 108S adapter kit, use an "S" prefix (i.e., S-AU4707LN).

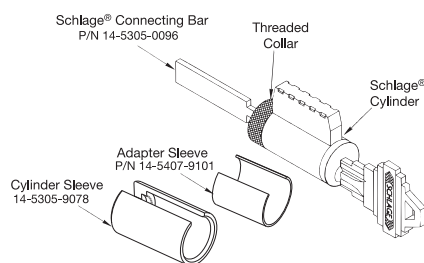



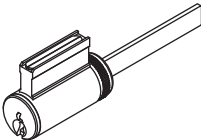

Cylinders/Keying

OTHER MANUFACTURER KEYWAY CYLINDER/CORES

Illustration	Type	Lever	Number of Pins
	Best® Keyway Core. Available keyed random, master keyed or uncombined. Specify keyway A, B, C, D, E, F, G, H, J, K, L or M.	A600	6 or 7 (Specify)
 Lever Cylinder	Schlage® C Keyway Cylinder. Available 0-bitted or keyed random.	2803-47L x C	6
	Corbin Russwin L4 Keyway Cylinder. Available keyed random.	3803-47L x L4	6
	Corbin 60 Keyway Cylinder. Available keyed random.	3803-47L x 60	6
	Russwin D1 Keyway Cylinder. Available keyed random.	3803-47L x D1	6
	Sargent® LA Keyway Cylinder. Available keyed random.	3803-47L x LA	6
	Schlage® E Keyway Cylinder. Available keyed random.	3803-47L x E	6

Notes: The 2803 and 3803 cylinders require a cylinder sleeve (P/N 14-1803-9001-999) to fit the 4700LN lockset.

LEVERS ACCEPTING SFIC AND OTHER MANUFACTURERS' LARGE FORMAT INTERCHANGEABLE CORES

Illustration	Cylinder Type	Prefix	Number of Pins
	SFIC (Accepts all Small Format Interchangeable Cores)	B (i.e. B-AU, B-MO, B-PB)	6 or 7
	Medeco®, ASSA® (LFIC)	M* (i.e. M-AU)	6
	Schlage® (LFIC)	SI (i.e. SI-AU, SI-PB)	6

*Medeco®, ASSA® option available only with AU lever. (Note: For Medeco 32 series cores.)

LFIC = Large Format Interchangeable Core

SFIC = Small Format Interchangeable Core



Latchbolts

PLAIN LATCHBOLTS

Model No. 693 supplied standard with all 4700LN series locksets without locking function. Standard plain latchbolt has a 2-1/4" (57mm) x 1-1/8" (29mm) beveled front with a 2-3/4" (70mm) backset and a 1/2" (13mm) bolt throw. Optional latchbolts with a greater backset/throw available to special order.

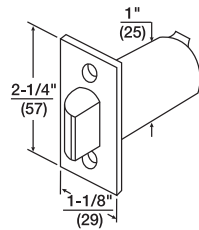

Model No.	Front	Backset	Throw	Front Width	Latch Diameter
693	Beveled	2-3/4" (70mm)	1/2" (13mm)	1-1/8" (29mm)	1" (25mm)
F693	Flat	2-3/4" (70mm)	1/2" (13mm)	1-1/8" (29mm)	1" (25mm)
3693	Beveled	3-3/4" (95mm)	1/2" (13mm)	1-1/8" (29mm)	1" (25mm)

Note: for 3/4" throw applications, only deadlocking latchbolts available.

DEADLOCKING LATCHBOLTS

Deadlocking latchbolt Model No. 694 supplied standard with all 4700(LN) series locksets with locking function. Standard deadlocking latchbolt has a 2-1/4" (57mm) x 1-1/8" (29mm) beveled front with a 2-3/4" (70mm) backset and a 1/2" (13mm) bolt throw. Optional latchbolts with a greater backset/throw available to special order.

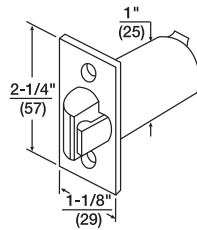

Model No.	Front	Backset	Throw	Front Width	Latch Diameter
694	Beveled	2-3/4" (70mm)	1/2" (13mm)	1-1/8" (29mm)	1" (25mm)
F694	Flat	2-3/4" (70mm)	1/2" (13mm)	1-1/8" (29mm)	1" (25mm)
3694	Beveled	3-3/4" (95mm)	1/2" (13mm)	1-1/8" (29mm)	1" (25mm)
480B	Beveled	2-3/4" (70mm)	3/4" (19mm)	1-1/8" (29mm)	1" (25mm)
F480B	Flat	2-3/4" (70mm)	3/4" (19mm)	1-1/8" (29mm)	1" (25mm)
3480B	Beveled	3-3/4" (95mm)	3/4" (19mm)	1-1/8" (29mm)	1" (25mm)

Note: For 2-3/8" backset, contact Customer Support.

BACKSET EXTENSION LINKS

All 4700LN Series locksets are supplied with standard latchbolts of 2-3/4" (70mm) backset; optional latchbolts with a 3-3/4" (95mm) backset are available to special order for lever locksets only. Extension links are also available for attachment to 2-3/4" (70mm) or 3-3/4" (95mm) backset latchbolts to extend the backset to the desired length.

Desired Backset	Latchbolt Backset	Order Extension List No.
5" (127mm)	2-3/4" (70mm)	481DL
6" (152mm)	3-3/4" (95mm)	481
7" (178mm)	2-3/4" (70mm)	482
8" (203mm)	3-3/4" (95mm)	482
18" (46cm)	2-3/4" (70mm)	484
19" (48cm)	3-3/4" (95mm)	484

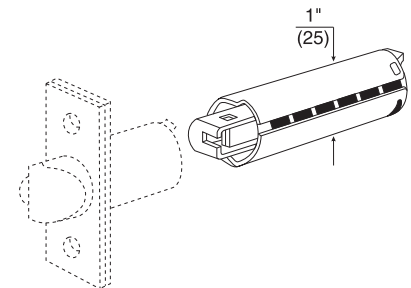

Other extension links up to 42" (1.06m) backset are available to special order.

ATTACHING SCREWS

(Not regularly supplied when latchbolts ordered separately).

- For all latchbolts**

- #8-32 x 3/4" (19mm) Phillips flat head combination wood and machine screws
- Brass - P/N 81-2022-0416*
- Bronze - P/N 81-2032-0416*

*Specify finish required.

- Hollow Metal Doors**

- #8 - 32 x 1" (25mm) Phillips flat head machine screw
- Brass - P/N 81-0022-0420*
- Bronze - P/N 81-0032-0420*



Strikes

Yale® 4700LN locks are available with a variety of strike options. All strikes are located on the same vertical and horizontal center lines as the latchbolt. Some strikes are available in a variety of lip lengths to accommodate varying thickness of doors and frames. To determine the proper length of the lip, measure from the center line of the strike to the edge of the jamb, accounting for any interfering trim (i.e. wood molding) and then add 1/4" (6mm) for curved lip. All strikes are reversible. Strikes are fabricated of either brass, bronze or stainless steel, depending on the lockset trim finish. When ordering strikes separately, specify the finish required.

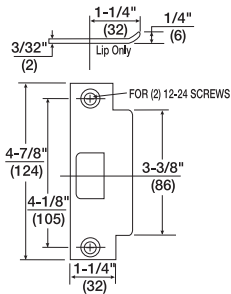

Model No. 497 ANSI Strike (Standard)

For door and frames with ANSI/BHMA A156.115 preparations. 4-7/8" x 1-1/4" x 1-1/4" (124mm x 32mm x 32mm) lip to center supplied standard. 1-1/8", 1-1/2", and 1-3/4" lip lengths available by special order. Available with optional 202 Strike Box. Specify 497 x 202.

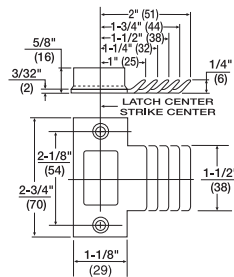

Model No. 371 T-Strike (Optional)

2-3/4" x 1-1/8" x 1-1/4" (70mm x 29mm x 32mm) lip to center available as an option. 1", 1-1/2", 1-3/4" and 2" curved lip lengths available by special order. Wrought strike box supplied.

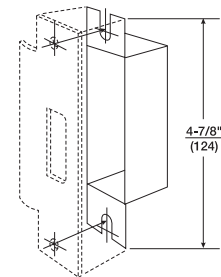

Model No. 202 Strike Box (Optional)

Available to special order. Specify 497 x 202.

ATTACHING SCREWS

(Not regularly supplied when strikes ordered separately).

For Model No. 497

#12-24 x 1" Phillips flat head combination wood and machine screws.
P/N 81-2012-0620

For Model No. 371

#8-32 x 3/4" (19mm) Phillips flat head combination wood and machine screws.
P/N 81-2012-0416



Notes

Contact Us

The world's favorite lock



U.S.A.

Yale Locks & Hardware

Address: 225 Episcopal Road
Berlin, CT 06037-4004
Tel: 1-800-438-1951
Fax: 1-800-338-0965
yalelocks.com

Canada:

ASSA ABLOY Door Security Solutions Canada

Address: 160 Four Valley Drive
Vaughan, Ontario L4K 4T9
Tel: 1-800-461-3007
Fax: 1-800-461-8989
assaabloydss.ca

International:

ASSA ABLOY Americas International

Tel: 1-905-821-7775
Fax: 1-905-821-1429
assaabloyai.com

Yale Commercial is a business associated with ASSA ABLOY Access and Egress Hardware Group, Inc., an ASSA ABLOY Group company. Copyright © 2010-2019, ASSA ABLOY Access and Egress Hardware Group, Inc. All rights reserved. Reproduction in whole or in part without the express written permission of ASSA ABLOY Access and Egress Hardware Group, Inc. is prohibited. Patent pending and/or patent www.assaabloydss.com/patents.

YALE, with its unique global reach and range of products, is the world's favorite lock.

ASSA ABLOY is the global leader in door opening solutions, dedicated to satisfying end-user needs for security, safety and convenience.

42702-5/19



4600(LN) Series

ANSI/BHMA Grade 2 Certified Cylindrical Locks



Table of Contents



Contents

Benefits & Features.....	3
How to Order	4
Finishes	5
Trim Designs.....	6
Functions.....	7-8
Cylinders/Keying	9
Latchbolts	10
Strikes.....	11

4600(LN) Cylindrical Locks

Yale® 4600(LN) cylindrical locks are the ideal choice for a wide variety of commercial applications where consistent quality, ease of use and installation are required at an economical price. The 4600(LN) Series is certified to ANSI/BHMA Grade 2 standards and is UL fire-listed for all functions, ensuring reliability and peace of mind.

To make your building work better with your budget, Yale Works for YouSM.



Benefits & Features

Benefits

- **Versatile:** Field reversible handing and other product options offer flexibility in many commercial applications
- **Economical:** Priced affordably to suit projects of all budgets
- **Secure:** Quality security from a trusted brand for over 170 years
- **Strong & Reliable:** ANSI/BHMA Grade 2 certified for long life and reliability

Features

- Field reversible handing for easy installation
- Range of functions and options for a wide variety of commercial applications
- Available in five trims and nine finishes
- ADA compliant for ease of accessibility



Specifications

Door Prep	ANSI/BHMA A156.115
Door Thickness	Adjustable for doors 1-3/8" to 1-3/4" (35mm to 44mm)
Backset	2-3/4" (70mm) standard, 2-3/8" (60mm) optional
Handing	Non-handed, field reversible
Latchbolt	2-3/4" (70mm) backset, 1/2" (13mm) throw latchbolt plain or deadlocking. See page 10 for additional options.
Strike	ANSI strike 4-7/8" x 1-1/4" x 1-1/4" (124mm x 32mm x 32mm) lip to center. See page 11 for additional options.
Through-bolts	Optional through-bolts provided. Installation is at the discretion of the installer.
ANSI/BHMA	Certified Grade 2, ANSI/BHMA A156.2, Series 4000
UL/cUL	Listed for 3 hour fire doors
Windstorm	Certified, check local codes.
Warranty:	3 years



Hurricane



How To Order



Design	Function	Hand	Latch	Strike	Cylinder	Door Thickness	Keying	Finish
Levers	4601LN - Passage or Closet Latch (Lever)	Specify	See page 10 for options.	497 strike standard for lever trim; 371 T-strike standard for knob trim. See page 11 for additional options.	1805 (knob) or 1806 (lever) 6-pin cylinder standard; see page 9 for additional options.	Adjustable between 1-3/8" to 1-3/4"; please specify.	KR (keyed random) standard, see page 9 for additional details/options.	605 - Bright Brass, Clear Coated 606 - Satin Brass, Clear Coated 612 - Satin Bronze, Clear Coated 613E - Dark Oxidized Satin Bronze - equivalent 625 - Bright Chrome Plated 626 - Satin Chrome Plated 629 - Bright Stainless Steel 630 - Satin Stainless Steel BSP - Black Suede Powder Coat
AU - Augusta	4601 - Passage or Closet Latch (Knob)	RH						
MO - Monroe	4602LN - Privacy, Bedroom or Bath Lock (Lever)	LH						
PB - Pacific Beach	4602 - Privacy, Bedroom or Bath Lock (Knob)							
TB	4604LN - Entry Lock (Lever only)							
Knob	4605LN - Storeroom or Closet Lock (Lever)							
CA - Carolina	4605 - Storeroom or Closet Lock (Knob)							
	4607LN - Entry Lock (Lever)							
	4607 - Entry Lock (Knob)							
	4608LN - Classroom Lock (Lever)							
	4608 - Classroom Lock (Knob)							
	4628LN - Communicating Passage Lock (Lever only)							
	4655LN - Single Dummy Trim (Lever)							
	4655 - Single Dummy Trim (Knob)							

Ordering Example

Design	Function	Hand	Latch	Strike	Cylinder	Door Thickness	Keying	Finish
AU	4607LN	RH	MCD234	497	1806	1-3/4"	KR	626

Finishes



ANSI/BHMA Code Finish Description		
605 Bright Brass, Clear Coated	606 Satin Brass, Clear Coated	612 Satin Bronze, Clear Coated
		
613E Dark Oxidized Satin Bronze - equivalent	625¹ Bright Chrome Plated	626¹ Satin Chrome Plated
		
629² Bright Stainless Steel	630² Satin Stainless Steel	BSP¹ Black Suede Powder Coat
		

1. Finish available for lever trim only.

2. Finish available for knob trim only.

Trim Designs



Levers

Augusta AU

Lever: Cast Zinc
Rose: Wrought Brass

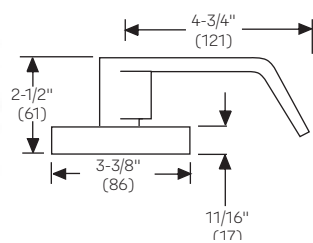

Pacific Beach PB

Lever: Cast Zinc
Rose: Wrought Brass

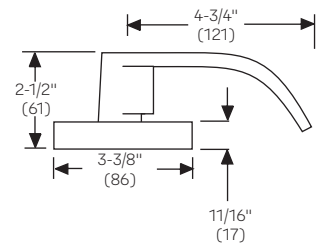

Monroe MO

Lever: Cast Zinc
Rose: Wrought Brass

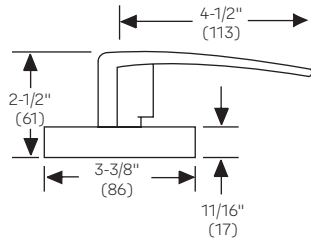

TB

Lever: Cast Zinc
Rose: Wrought Brass

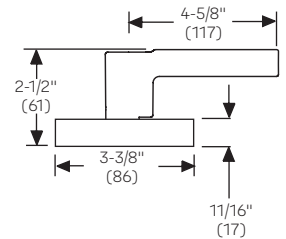

Note: Except for 626 finish, extended lead times apply for Monroe (MO) lever handle. Contact Customer Service for more information.

Knob

Carolina CA

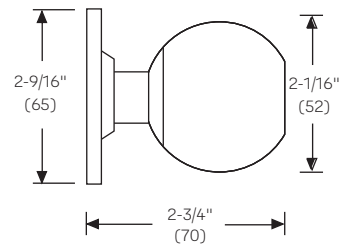

Knob: Stainless Steel or
Wrought Brass
Rose: Stainless Steel or
Wrought Brass



All levers and knob available with small format interchangeable core. See page 9 for details.

Dimensions shown are in inches/mm.

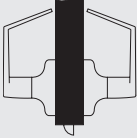
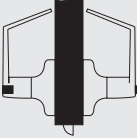
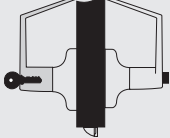
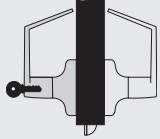
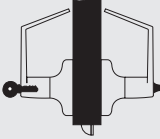
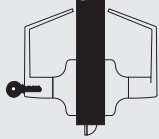
Levers

<p style="text-align: center;">4601LN (F75)</p>  <p>Passage or Closet Latch</p> <ul style="list-style-type: none"> • For doors that do not require locking. • Either lever operates latchbolt at all times. 	<p style="text-align: center;">4602LN (F76A)</p>  <p>Privacy, Bedroom or Bath Lock</p> <ul style="list-style-type: none"> • For lavatory or other privacy doors. • Either lever operates latchbolt unless outside lever is locked by pushbutton inside. • Button automatically releases when inside lever is turned or door is closed. • Emergency release in outside lever. • Inside lever always active. 	<p style="text-align: center;">4604LN (F82A)</p>  <p>Entry Lock</p> <ul style="list-style-type: none"> • For entrance or office doors. • Deadlocking latchbolt. • Either lever operates latchbolt (except when outside lever is locked from inside).* • Pushing button in inside lever locks outside lever. (Automatically releases when inside lever is turned or key is rotated in locked outside lever.) • Latchbolt is operated by key in outside lever or by rotating inside lever. • Inside lever always active.
<p style="text-align: center;">4605LN (F86)</p>  <p>Storeroom or Closet Lock</p> <ul style="list-style-type: none"> • For use on storeroom, utility, exit doors. • Deadlocking latchbolt. • Latchbolt operated by lever inside, key in outside lever. • Outside lever always rigid. • Inside lever always active. 	<p style="text-align: center;">4607LN (F109)</p>  <p>Entry Lock</p> <ul style="list-style-type: none"> • For entrance, general home or office doors. • Deadlocking latchbolt. • Either lever operates latchbolt (except when outside lever is locked from inside). • Pushing turn button in inside lever locks outside lever. (Automatically releases when inside lever is turned or key is rotated in locked outside lever.) • Outside lever may be retained in locked position by pushing and rotating turn button 90° clockwise to a horizontal position; not released until turn button is manually returned to the vertical position. • Latchbolt is operated by key in outside lever or by rotating inside lever. • Inside lever always active. 	<p style="text-align: center;">4608LN (F84)</p>  <p>Classroom Lock</p> <ul style="list-style-type: none"> • For classroom or utility room doors. • Deadlocking latchbolt. • Either lever operates latchbolt (except when outside lever is locked by key). • Inside lever always active. • Key releases outside lever.
<p style="text-align: center;">4628LN (F111)</p>  <p>Communicating Passage Lock</p> <ul style="list-style-type: none"> • For twin communicating or exit doors where one side operation is required. • Also when space is limited between door and switch panel. • Deadlocking latchbolt. • One lever operation. • Blank rose. • Should be used only where rooms have more than one entrance. 	<p style="text-align: center;">4655LN</p>  <p>Single Dummy Trim</p> <ul style="list-style-type: none"> • For non-operational levers used for decorative trim. • Rigid lever. 	

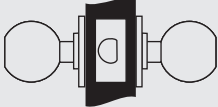
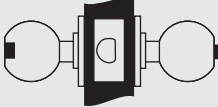
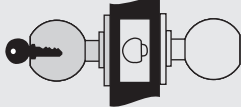
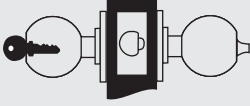
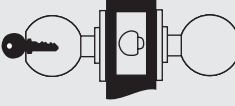
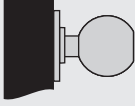

Knobs

4601 (F75)	4602 (F76A)	4605 (F86)
 <p>Passage or Closet Latch</p> <ul style="list-style-type: none"> • For doors that do not require locking. • Either knob operates latchbolt at all times. 	 <p>Privacy, Bedroom or Bath Lock</p> <ul style="list-style-type: none"> • For lavatory or other privacy doors. • Either knob operates latchbolt unless outside knob is locked by pushbutton inside. • Button automatically releases when inside knob is turned or door is closed. • Emergency release in outside knob. • Inside knob always active. 	 <p>Storeroom or Closet Lock</p> <ul style="list-style-type: none"> • For use on storeroom, utility, exit doors. • Deadlocking latchbolt. • Latchbolt operated by knob inside, key in outside knob. • Outside knob always rigid. • Inside knob always active.
4607 (F109)	4608 (F84)	4655
 <p>Entry Lock</p> <ul style="list-style-type: none"> • For entrance, general home or office doors. • Deadlocking latchbolt. • Either knob operates latchbolt (except when outside knob is locked from inside). • Pushing turn button in inside knob locks outside knob. (Automatically releases when inside knob is turned or key is rotated in locked outside knob.) • Outside knob may be retained in locked position by pushing and rotating turn button 90° clockwise to a horizontal position; not released until turn button is manually returned to the vertical position. • Latchbolt is operated by key in outside knob or by rotating inside knob. • Inside knob always active. 	 <p>Classroom Lock</p> <ul style="list-style-type: none"> • For classroom or utility room doors. • Deadlocking latchbolt. • Either knob operates latchbolt (except when outside knob is locked by key). • Inside knob always active. • Key releases outside knob. 	 <p>Single Dummy Trim</p> <ul style="list-style-type: none"> • For non-operational levers used for decorative trim. • Rigid knob.

Cylinders/Keying



Illustration	Type	Model Number	Number of Pins
	Key-in-Knob Cylinder	1805 (Knob)	6
	Key-in-Lever Cylinder	1806 (Lever)	6

Keying:

All cylinders furnished standard 6-pin, keyed random in Yale® PARA keyway, pinned to Yale .019" specification. Each cylinder furnished with two nickel silver keys. Optional Yale keyways available upon request, extended lead times may apply.

Options:

Cylinders available 0-bitted, keyed alike, master keyed or construction master keyed upon request. Cylinders provided in 605 and 626 finishes only.

Levers/Knobs Accepting Small Format Interchangeable Cores

Illustration	Cylinder Type	Prefix	Ordering Example
	SFIC (Accepts all Small Format Interchangeable Cores) 6- or 7-pin.	B (i.e. B-AU, B-MO, B-PB, B-TB, B-CA)	B-PB-4607LN x 626

Other Manufacturers Keyway Cylinders/Cores

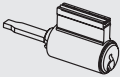
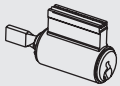
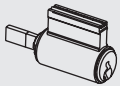
Illustration	Type	Model Number	Number of Pins
	Best® Keyway Core. Available keyed random, master keyed or uncombined. Specify keyway A, B, C, D, E, F, G, H, J, K, L or M.	A600	6 or 7 (Specify)
	Schlage® C Keyway Knob Cylinder. Available 0-bitted or keyed random.	2805 x C	6
	Schlage® C Keyway Lever Cylinder. Available 0-bitted or keyed random.	2806 x C	6
	Corbin Russwin L4 Keyway Cylinder. Available keyed random.	3806 x L4	6
	Corbin 60 Keyway Cylinder. Available keyed random.	3806 x 60	6
	Russwin D1 Keyway Cylinder. Available keyed random.	3806 x D1	6
	Sargent® LA Keyway Cylinder. Available keyed random.	3806 x LA	6
	Schlage® E Keyway Cylinder. Available keyed random.	3806 x E	6

Note: 2805, 2806 and 3806 cylinders are supplied with applicable tailpieces that are needed to operate 4600(LN) locksets. These cylinders are not ANSI/BHMA certified.

Latchbolts



Plain Latchbolts

Model No. MCP234 supplied standard with all 4600(LN) series locksets without locking function. Model No. MCP234 latchbolt has a 2-1/4" x 1-1/8" front with a 2-3/4" backset and a 1/2" bolt throw. Optional latchbolts available to special order.

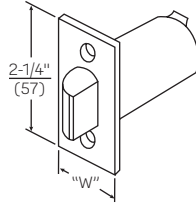

Model Number	Front	Backset	Throw	"W" Front Width	Latch Diameter*
MCP238	Square	2-3/8" (60mm)	1/2" (13mm)	1" (25mm)	7/8" (22mm)
MCP238R	Round	2-3/8" (60mm)	1/2" (13mm)	1" (25mm)	7/8" (22mm)
MCP234	Square	2-3/4" (70mm)	1/2" (13mm)	1-1/8" (29mm)	7/8" (22mm)

*1/8" sleeve (P/N 14-0378-9001) supplied with all latchbolts to accommodate 1" preps.

Deadlocking Latchbolts

Model No. MCD234 supplied standard with all 4600(LN) series locksets with locking function. Model No. MCD234 latchbolt has a 2-1/4" x 1-1/8" front with a 2-3/4" backset and a 1/2" bolt throw. Optional latchbolts available to special order.

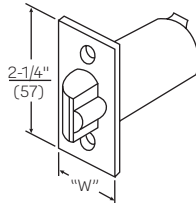

Model Number	Front	Backset	Throw	"W" Front Width	Latch Diameter*
MCD238	Square	2-3/8" (60mm)	1/2" (13mm)	1" (25mm)	7/8" (22mm)
MCD238R	Round	2-3/8" (60mm)	1/2" (13mm)	1" (25mm)	7/8" (22mm)
MCD234	Square	2-3/4" (70mm)	1/2" (13mm)	1-1/8" (29mm)	7/8" (22mm)

*1/8" sleeve (P/N 14-0378-9001) supplied with all latchbolts to accommodate 1" preps.

Note: Locksets ordered with 2-3/8" backset square or round latchbolts will automatically include the corresponding 70S or 71S full lip strike as standard. Order must specify if alternate strike required.

Strikes



Yale® 4600(LN) locks are available with a variety of strike options. All strikes are located on the same vertical and horizontal center lines as the latchbolt. Some strikes are available in a variety of lip lengths to accommodate varying thickness of doors and frames. To determine the proper length of the lip, measure from the center line of the strike to the edge of the jamb, accounting for any interfering trim (i.e. wood molding) and then add 1/4" (6mm) for curved lip. All strikes are reversible. Strikes are fabricated of either brass, bronze or stainless steel, depending on the lockset trim finish. When ordering strikes separately, specify the finish required.

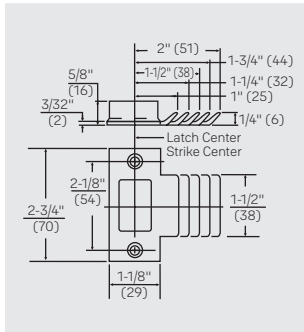

Model No. 371 T-Strike (Standard for Knob - Optional for Lever)
 2-3/4" x 1-1/8" x 1-1/4"
 (70mm x 29mm x 32mm) lip to center supplied standard for knob. 1", 1-1/2", 1-3/4" and 2" curved lip lengths available by special order. Wrought strike box supplied.

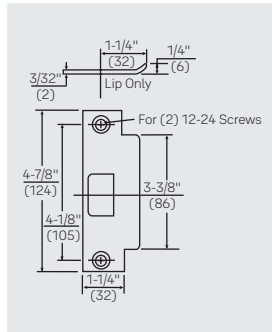

Model No. 497 ANSI Strike (Standard for Lever - Optional for Knob)
 For door and frames with ANSI/BHMA A156.115 preparations. 4-7/8" x 1-1/4" x 1-1/4" (124mm x 32mm x 32mm) lip to center supplied standard for lever. 1-1/8", 1-1/2", and 1-3/4" lip lengths available by special order. Available with optional 202 Strike Box. Specify 497 x 202.

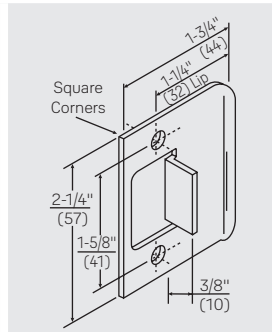

Model No. 70S Full Lip Strike (Optional for Knob or Lever)
 2-1/4" x 1-3/4" x 1-1/4"
 (57mm x 44mm x 32mm) lip to center with full lip anti-rattle tab.

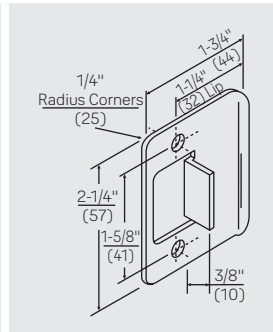

Model No. 71S Full Lip Strike (Optional for Knob or Lever)
 1/4" radius. Similar in dimensions and function to the 70S Strike but with radius corners for easy mortising by power tools. Anti-rattle tab.

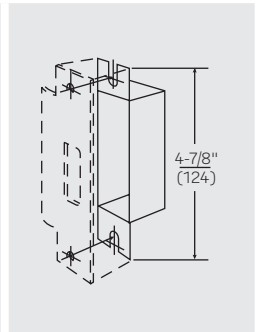

Model No. 202 Strike Box
 Available to special order. Specify 497 x 202.

Attaching Screws

For Model Nos. 371, 70S, and 71S

#8-32 x 3/4" (19mm) Phillips flat head combination wood and machine screws.

For Model No. 497

#12-24 x 1" (25mm) Phillips flat head combination wood and machine screws.



Trusted every day

Phone

1-855-557-5078

Customer Service Email

customerservice.yale@assaabloy.com

Technical Product Support Email

techsupport.yale@assaabloy.com

Order Entry Email

orders.yaleus@assaabloy.com

Fax

1-800-338-0965

Website

www.yalecommercial.com

Contact Us

U.S.A.

Yale Locks & Hardware

Address: 225 Episcopal Road

Berlin, CT 06037-4004

Tel: 1-800-438-1951

Fax: 1-800-338-0965

yalecommercial.com

Canada:

ASSA ABLOY Door Security Solutions Canada

Address: 160 Four Valley Drive

Vaughan, Ontario L4K 4T9

Tel: 1-800-461-3007

Fax: 1-800-461-8989

assaabloydss.ca

International:

ASSA ABLOY Americas International

Tel: 1-905-821-7775

Fax: 1-905-821-1429

assaabloyai.com

THE YALE BRAND, with its unparalleled global reach and range of products, reassures more people in more countries than any other consumer locking solution.

THE ASSA ABLOY GROUP is the world's leading manufacturer and supplier of locking solutions, dedicated to satisfying end-user needs for security, safety and convenience.

Yale Commercial is a business associated with ASSA ABLOY Access and Egress Hardware Group, Inc., an ASSA ABLOY Group company. Copyright © 2010-2021, ASSA ABLOY Access and Egress Hardware Group, Inc. All rights reserved. Reproduction in whole or in part without the express written permission of ASSA ABLOY Access and Egress Hardware Group, Inc. is prohibited. Patent pending and/or patent www.assaabloydss.com/patents.



6400LN Monolock

Pre-Assembled Retrofit Locks



convenience and versatility

Introduction

Based on the Yale® 5400LN Grade 1 cylindrical lockset, the 6400LN Monolock continues the tradition of quality and dependability as a preassembled lock series designed to retrofit existing Yale® Monolock as well as Corbin Russwin Unit Lock and Falcon® Retrofit Lock installations with 1-3/4" latch height.

Featuring a Free Wheeling lever mechanism as an increased deterrent to vandalism, the 6400LN is also ADA compliant and UL listed. As a retrofit lock, installing the 6400LN is a cost-effective alternative to expensive door modification or replacement. In addition, easy installation and the ability to use existing key systems make the 6400LN Monolock convenient and versatile.

As a lock industry leader for over 160 years, Yale has built a reputation on providing the highest level of reliability available in the market. Proven performance is the foundation on which all of our products are manufactured. Our goal at Yale is to provide superior products and services, at a competitive price, on time, every time.

A.D.A

The 6400LN meets accessibility guidelines of the Americans with Disabilities Act and the requirements of the Uniform Federal Accessibility Standards and ANSI 117.1, all requiring ease of accessibility for the handicapped.

microshield®

6400LN Series Locks are available with *MicroShield* antimicrobial coating. *MicroShield* is a revolutionary hardware finish coating, using a silver ion based technology, which inhibits the growth of bacteria, algae, yeast, fungus, mold and mildew. *MicroShield* is non-toxic and lasts for the lifetime of the finish to which it is applied. To order, suffix option code "YMS".



Note: *MicroShield* coating may vary finish color from architectural standards. *MicroShield* is not intended as a substitute for traditional infection control programs such as hand hygiene or use of disinfectants. Coated products must still be cleaned to insure the surfaces will be free of destructive microbes. Yale makes no representations or warranties, express or implied, as to the efficacy of *MicroShield*.

handing

Handing must be specified for all functions and designs of the 6400LN.

door thickness

Fits doors 1-3/4" thick only.

iso 9001

Designed and manufactured under a certified ISO 9001 quality system.

fire listings

UL-cUL "B" Fire Label for all functions up to minutes.

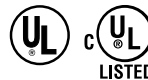

Note: Any retrofit or other field modification to a fire rated opening can potentially impact the fire rating of the opening, and Yale Locks & Hardware makes no representations or warranties concerning what such impact may be in any specific situation. When retrofitting any portion of an existing fire rated opening, or specifying and installing a new fire-rated opening, please consult with a code specialist or local code official (Authority Having Jurisdiction) to ensure compliance with all applicable codes and ratings.

contents

Introduction	2
Features	2
Lever Designs.....	3
Functions	4-6
Cylinders	7-8
Strikes	9
Ordering Information.....	10

finishes

ANSI/BHMA Code	Finish Description
626	Satin Chrome Plated 

Additional finishes for levers/rosettes by special application although latch housing only available in 626. Contact factory for availability.

free wheeling lever trim

All 6400LN locking functions feature the *Yale* Free Wheeling lever mechanism. When locked, the outside lever will rotate freely up and down without retracting the latch.



warranty

The 6400LN Series Monolock carries a seven-year warranty.

lever designs

Augusta AU

Lever: Cast Zinc
Rose: Cold Forged Brass, Bronze

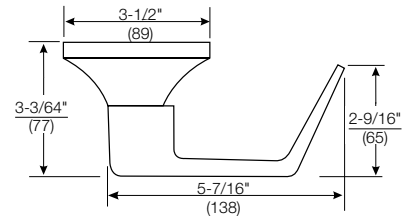

Monroe MO

Lever: Cast Zinc
Rose: Cold Forged Brass, Bronze

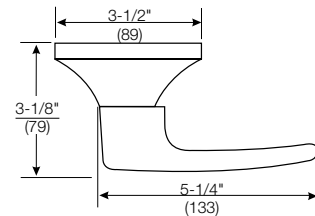

Pacific Beach PB

Lever: Cast Zinc
Rose: Cold Forged Brass, Bronze

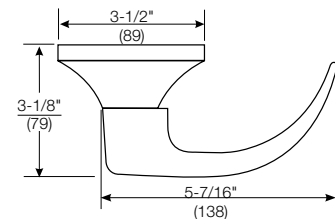

Dimensions are shown in inches (millimeters).
 See pages 7 and 8 for interchangeable core and cylinder options.

functions

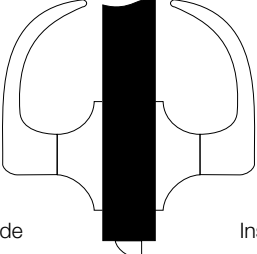
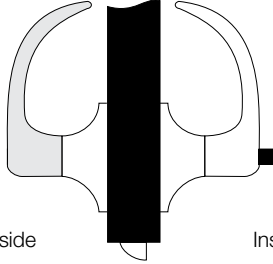
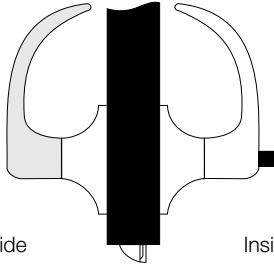
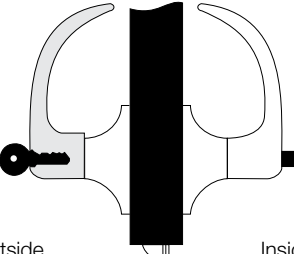
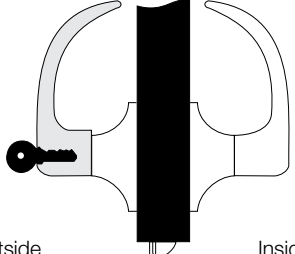
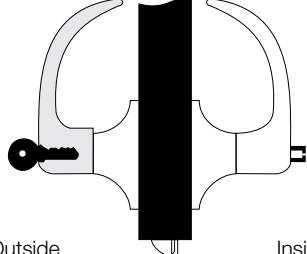
<p style="text-align: center;">6401LN</p> <p>Passage or Closet Latch</p> <ul style="list-style-type: none"> • For doors that do not require locking. • Either lever operates latchbolt at all times.  <p style="display: flex; justify-content: space-between;">OutsideInside</p>	<p style="text-align: center;">6402LN</p> <p>Privacy, Bedroom or Bath Lock</p> <ul style="list-style-type: none"> • For lavatory or other privacy doors. • Either lever operates latchbolt unless outside lever is locked by pushbutton inside.* • Button automatically releases when inside lever is turned or door is closed. • Emergency release in outside lever. Emergency key supplied. (PN 14-5302-1053-048) • Inside lever always active.  <p style="display: flex; justify-content: space-between;">OutsideInside</p>	<p style="text-align: center;">6403LN</p> <p>Patio or Privacy Lock</p> <ul style="list-style-type: none"> • For exit doors with limited entry. • Deadlocking latchbolt. • Either lever operates latchbolt unless outside lever is locked by pushbutton inside.* • Button automatically releases when inside lever is turned or door is closed. • Inside lever always active.  <p style="display: flex; justify-content: space-between;">OutsideInside</p>
<p style="text-align: center;">6404LN</p> <p>Entry Lock</p> <ul style="list-style-type: none"> • For entrance or office doors. • Deadlocking latchbolt. • Either lever operates latchbolt (except when outside lever is locked from inside).* • Pushing button in inside lever locks outside lever. (Automatically releases when inside lever is turned or key is rotated in locked outside lever.) • Latchbolt is operated by key in outside lever or by rotating inside lever. • Inside lever always active.  <p style="display: flex; justify-content: space-between;">OutsideInside</p>	<p style="text-align: center;">6405LN</p> <p>Storeroom or Closet Lock</p> <ul style="list-style-type: none"> • For use on storeroom, utility, and exit doors. • Deadlocking latchbolt. • Latchbolt operated by lever inside, key in outside lever. • Outside lever always locked.* • Inside lever always active.  <p style="display: flex; justify-content: space-between;">OutsideInside</p>	<p style="text-align: center;">6406LN</p> <p>Service Station Lock</p> <ul style="list-style-type: none"> • Deadlocking latchbolt. • Either lever operates latchbolt. • Pushbutton in inside lever locks outside lever. (Automatically releases when inside lever is turned, door is closed or key is rotated in outside lever, except when slotted pushbutton is rotated 90° clockwise to retain outside lever in locked position.)* • Latchbolt operated by key in outside lever, inside lever always active.  <p style="display: flex; justify-content: space-between;">OutsideInside</p>

* Lever handles are Free Wheeling in locked position. Shaded area denotes Free Wheeling lever.

functions

<p style="text-align: center;">6407LN</p> <p>Entry Lock</p> <ul style="list-style-type: none"> • For entrance, general home or office doors. • Deadlocking latchbolt. • Either lever operates latchbolt (except when outside lever is locked from inside).* • Pushing turn button in inside lever locks outside lever, and automatically releases when inside lever is turned or key is rotated in locked outside lever. • Outside lever may be retained in locked position by pushing and rotating turn button 90° clockwise to a horizontal position; not released until turn button is manually returned to the vertical position. • Latchbolt is operated by key in outside lever or by rotating inside lever. • Inside lever always active. <div style="text-align: center;"> <p>Outside Inside</p> </div>	<p style="text-align: center;">6408LN</p> <p>Classroom Lock</p> <ul style="list-style-type: none"> • For classroom or utility room doors. • Deadlocking latchbolt. • Either lever operates latchbolt (except when outside lever is locked by key).* • Inside lever always active. • Outside lever locked or unlocked only by key. <div style="text-align: center;"> <p>Outside Inside</p> </div>	
<p style="text-align: center;">6409LN</p> <p>Exit Latch</p> <ul style="list-style-type: none"> • For exit doors with no-entry desired. • Deadlocking latchbolt. • Outside lever always locked. • Inside lever always active. <div style="text-align: center;"> <p>Outside Inside</p> </div>	<p style="text-align: center;">6417LN</p> <p>Apartment, Exit or Public Toilet Lock</p> <ul style="list-style-type: none"> • For office or apartment building entrance doors or lavatory doors. • Deadlocking latchbolt. • Either lever operates latchbolt (except when outside lever is locked by key from inside).* • Key in outside lever operates latchbolt. • Inside lever always active. <p>NOTE: Inside handle requires 1802S standard 6-pin cylinder.</p> <div style="text-align: center;"> <p>Outside Inside</p> </div>	<p style="text-align: center;">6418LN</p> <p>Intruder Classroom Security Lock</p> <ul style="list-style-type: none"> • For classroom doors. • Deadlocking latchbolt. • Either lever operates latchbolt (except when outside lever is locked by key from either side). • Key either inside or outside locks or unlocks outside lever. • Inside lever always active. <div style="text-align: center;"> <p>Outside Inside</p> </div>

* Lever handles are Free Wheeling in locked position. Shaded area denotes Free Wheeling lever.

functions

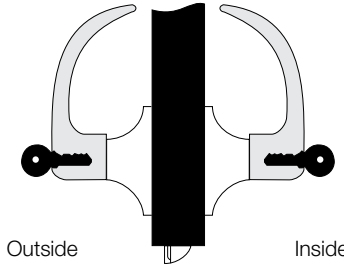
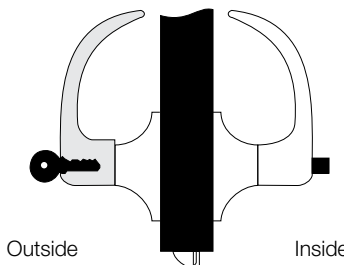
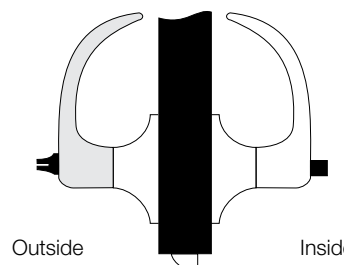
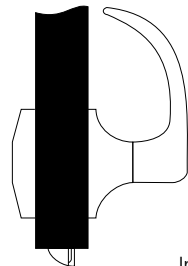
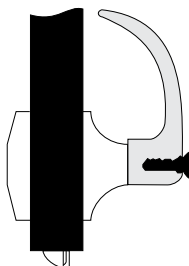
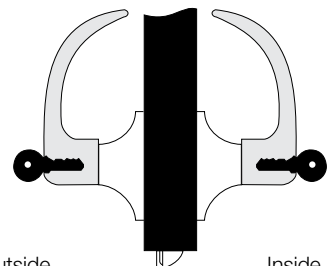
<p style="text-align: center;">6421LN</p> <p>Communicating Lock</p> <ul style="list-style-type: none"> • For communicating or store entrance doors. • Deadlocking latchbolt. • Either lever operates latchbolt (except when key in either lever locks or unlocks the lever independently of the other).* • Should be used only in offices or rooms with multiple entries. <p>(Not available with I.C. core cylinders.)</p>  <p style="display: flex; justify-content: space-between;">OutsideInside</p>	<p style="text-align: center;">6422LN</p> <p>Corridor Lock</p> <ul style="list-style-type: none"> • Deadlocking latchbolt. • Either lever operates latchbolt (except when outside lever is locked by inside pushbutton or key in outside lever).* Inside lever always active. • When locked by button, the button automatically releases when inside lever is turned or door is closed. • When locked by key, the automatic release is made inoperative and must be manually unlocked by the key.*  <p style="display: flex; justify-content: space-between;">OutsideInside</p>	<p style="text-align: center;">6425LN</p> <p>Privacy Lock</p> <ul style="list-style-type: none"> • For lavatory or other privacy doors. • Either lever operates latchbolt (except when outside lever is locked by inside pushbutton).* • Button automatically releases by turning inside lever or closing door. • Door can be unlocked, when necessary, by operating outside turnbutton. • No emergency key required. • Optional flush turnbutton available for outside. Specify option "FTB".  <p style="display: flex; justify-content: space-between;">OutsideInside</p>
<p style="text-align: center;">6428LN</p> <p>Communicating Passage Lock</p> <ul style="list-style-type: none"> • For twin communicating or exit doors where one side operation is required. • Use where space is limited. • Deadlocking latchbolt. • One lever operation. • Blank rose. • Should be used only where rooms have more than one entrance.  <p style="display: flex; justify-content: space-between;">OutsideInside</p>	<p style="text-align: center;">6429LN</p> <p>Communicating Classroom Lock</p> <ul style="list-style-type: none"> • For twin communicating or closet doors where one side operation or space between doors is limited. • Deadlocking latchbolt. • Inside lever operates latchbolt except when lever is locked by key.* <p>(Not available with IC core cylinders.)</p>  <p style="display: flex; justify-content: space-between;">OutsideInside</p>	<p style="text-align: center;">6430LN</p> <p>Utility, Asylum or Institutional Lock</p> <ul style="list-style-type: none"> • Deadlocking latchbolt. • Latchbolt operated by key in lever from either side. • Both levers always locked.* <p>(Not available with IC core cylinders.)</p>  <p style="display: flex; justify-content: space-between;">OutsideInside</p>

* Lever handles are Free Wheeling in locked position. Shaded area denotes Free Wheeling lever.

cylinders

cylinder options

The following selection guide indicates the correct cylinder for each locking segment.

Lockset Series: 6400LN		Types of Cylinder Mechanisms								
		Conventional		Protected Keyway		Security		High Security		
Cylinder Types	Fixed Core	6-pin	7-pin	6-pin	7-pin	6-pin	7-pin	6-pin	7-pin	
	Key-In-Lever	1802	1802A	K402	K402	5802	5802A	N/A	N/A	
	Interchangeable Core									
	LFIC	1210	1220	K800	K800	5210	5220	N/A	N/A	
SFIC	N/A	N/A	K600	K600	N/A	N/A	N/A	N/A		

Refer to Yale® KeyMark® and/or Cylinders and Keys Catalog sections for all details and how to order examples.

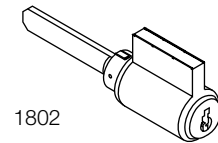

1802

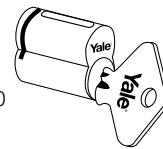

1210

Yale® KeyMark®

For those applications requiring protected key control, Yale® KeyMark® cylinders guard against unauthorized key duplication. The *Yale KeyMark Security Leg®* keyway feature increases resistance against picking and impressioning and can easily retrofit into existing systems. For further details and availability, refer to the separate *Yale KeyMark* catalog.



security cylinders

Security cylinders contain two independent locking mechanisms. The first is a traditional 6 or 7-pin tumbler mechanism with spool drivers for greatly increased picking resistance.

The second is an innovative 5-tumbler rotating disc mechanism with sidebar engagement. The rotating discs are spring loaded and block the bottom of the keyway.

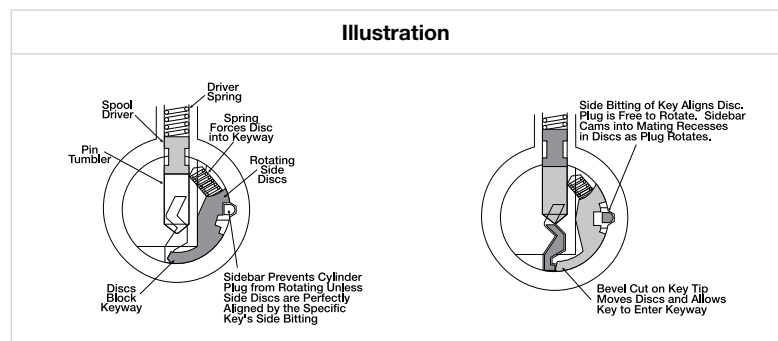



cylinders

107S Schlage® cylinder adapter kit

Used to modify Schlage® cylinder for fit in the 6400LN. P/N 14-5407-0300-048

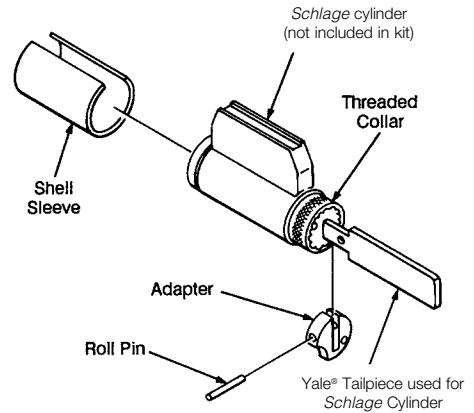

other manufacturer keyway cylinders

Illustration	Description	Model Number	Number of Pins
	Best® Keyway Cylinder. Available keyed random, master keyed or uncombined. Specify keyway A, B, C, D, E, F, G, H, J, K, L or M.	A600	6 or 7
	Schlage® "C" Keyway. Available 0-bitted or keyed random.	2802	6
	Corbin Russwin "L4", Corbin "60", Russwin "D1", Sargent® "LA" or Schlage® "E" Keyway. Specify keyway. Available keyed random.	3804*	6

***3804 cylinders require the 107S cylinder adapter kit to fit the 6400LN locksets. These cylinders are not ANSI/BHMA certified.**

levers accepting SFIC and other manufacturers' large format interchangeable cores

	Description	Prefix	Number of Pins
	SFIC (Accepts all Small Format Interchangeable Cores)	B (i.e. B-AU, B-MO, B-PB)	6 or 7
	Medeco®, ASSA® (LFIC)	M* (i.e. M-AU)	6
	Schlage® (LFIC)	SI (i.e. SI-AU, SI-PB, SI-MO)	6

***Medeco®, ASSA® option available only with AU lever. (Note: For Medeco 32 series cores.)**

LFIC = Large Format Interchangeable Core
SFIC = Small Format Interchangeable Core

strikes

Yale® 6400LN locks are available with a variety of strike options. All strikes are located on the same vertical and horizontal center lines as the latchbolt. Some strikes are available in special lip lengths to accommodate varying thickness of doors and frames. To determine the proper length of the lip, measure from the center line of the strike to the edge of the jamb, accounting for any interfering trim (i.e. wood molding) and then add 1/4" (6mm) for curved lip. All strikes are reversible. Strikes are fabricated of either brass, bronze or stainless steel, depending on the lockset trim finish. When ordering strikes separately, specify the finish required.

<p>Model No. 497 ANSI Strike (Standard) 1-1/4" supplied standard. 1-1/8", 1-1/2", and 1-3/4" lip lengths available by special order. For door and frames with ANSI/BHMA A156.115 preparations.</p>	<p>Model No. 371 T-Strike (Optional) 1-1/4" curved lip supplied standard. 1", 1-1/2", 1-3/4", and 2" curved lip lengths available by special order. Wrought strike box supplied.</p>	<p>Model No. 497B Blank ANSI Strike (Optional) Available to special order. Installed in frame with standard ANSI/BHMA A156.115 preparation to replace the strike when the lockset has been removed from the door.</p>
<p>Model No. 202 Strike Box for ANSI Strike (Optional) Specify 497 x 202</p>	<p>Model No. 64C Retrofit Strike 1-9/16" curved lip length, available in brass and bronze. For use when replacing the Corbin Russwin UT5200 Unit Lock with 6400LN Series.</p>	<p>Model No. 64Y Retrofit Strike 1-1/8" curved lip length, available in brass and bronze. For use when upgrading Yale® 6200 Monolocks to 6400LN Series.</p>

attaching screws

(Not regularly supplied when strikes ordered separately).

For Model No. 371 strike

#8-8-32 x 3/4" (19mm) Phillips flat head combination wood and machine screw P/N-81-2012-0416.

For Model No. 497 strike and 497B plate

#12-12-24 x 1" (25mm) Phillips flat head combination wood and machine screw P/N-81-2012-0620.

Note: When ordering strike plates or attaching screws individually, specify the finish required; i.e. 497 x 202 x 612; #81-2012-0620 x 612.

ordering information

From this outline select the Model Number for the Yale® 6400LN Series Cylindrical Lockset you require.

Design	Function	Strike	Cylinder	Finish	Hand
See Page 3	See Pages 4-6	See Page 9	See Pages 7-8	See Page 2	See Page 2

ordering example

Quantity	Design	Function	Strike	Cylinder	Finish	Hand
100	AU	6407LN	497	1802	626	RH

packing

Each box has a strike, paper template, combination wood and machine screws, lever release tool and easy-to-follow instructions. Allen wrench included with interchangeable cores. Cylinder functions supplied with two keys. Six shelf boxes to a case.



notes

online literature and templates

For the latest information on Yale Locks & Hardware products, visit our website at: www.yalelocks.com

Click on the “Product Information” button to find:

- Catalogs
- Parts manuals
- Templates
- Specifications
- Installation instructions

Yale® customers can click on the ebusiness symbol  on the website to register for an ebusiness account to:

- Check the status of orders
- Check availability of QuickShip items
- Track your order and confirm delivery
- Receive email notification of template changes
- And More...

Or contact us at:

U.S.A.

Yale Locks & Hardware

Address: 225 Episcopal Road, Berlin, CT 06037-4004
 Tel: 1-800-438-1951 • Fax: 1-800-338-0965 • www.yalelocks.com

Canada:

ASSA ABLOY Door Security Solutions Canada

Address: 160 Four Valley Drive, Vaughan, Ontario L4K 4T9
 Tel: 1-800-461-3007 • Fax: 1-800-461-8989 • www.assaabloy.ca

International:

ASSA ABLOY Americas International

Tel: 1-905-821-7775 • Fax: 1-905-821-1429 • www.assaabloyai.com

Yale Locks & Hardware is a division of Yale Security Inc., an ASSA ABLOY Group company.

Yale®, SecureX® and MicroShield® are registered trademarks of Yale Security Inc., an ASSA ABLOY Group company. Other products' brand names may be trademarks or registered trademarks of their respective owners and are mentioned for reference purposes only. These materials are protected under U.S. copyright laws. All contents current at time of publication. Yale Security Inc. reserves the right to change availability of any item in this catalog, its design, construction, and/or its materials. Copyright © 2001, 2014, Yale Security Inc., an ASSA ABLOY Group company. All rights reserved. Reproduction in whole or in part without the express written permission of Yale Security Inc., an ASSA ABLOY Group company is prohibited.

YALE, with its unique global reach and range of products, is the world's favorite lock.

ASSA ABLOY is the global leader in door opening solutions, dedicated to satisfying end-user needs for security, safety and convenience.

42130-5/14R



5400CK Series

Grade 1 Cylindrical Knob Locks





Table of Contents



Contents

Finishes.....	2
Introduction.....	3
How To Order	4
Functions.....	5
Trim Design.....	6
Cylinders	7
Latchbolts.....	8
Strikes	9
Specifications.....	10

Finishes

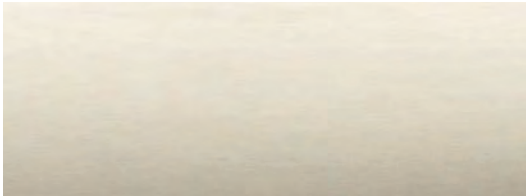
ANSI/BHMA Code Finish Description	
605 Bright Brass, Clear Coated	613E Dark Oxidized Satin Bronze - equivalent
	
630 Satin Stainless Steel	
	



Introduction

When demanding the highest standard of product performance in even the toughest industrial applications, look no further than the Yale® 5400CK Series Heavy-Duty Grade 1 cylindrical locksets.

Yale high-quality key-in-knob locksets offer the finest cylindrical lock mechanisms available. 5400CK Series locksets are assembled with superbly engineered components and constructed with high-grade materials for long-lasting reliability.

Manufactured for the industrial, commercial and institutional markets, 5400CK Series locksets feature security, dependability and versatility in attractive designs and finishes that fulfill all decorative requirements and blend with any architectural décor.

Internal parts are zinc dichromate plated for corrosion resistance

Heavy wrought knobs with steel liner for impact resistance



Multiple keying options

Stainless Steel 1/2" throw latchbolt

Features

- Constructed of heavy-gauge cold-rolled steel
- All parts zinc plated chromate for maximum corrosion resistance
- Recommended for use under normal climactic and environmental conditions

Applications and Listings

UL-cUL Listed for use on fire doors having a rating up to and including 3-hours.

Note: Any retrofit or other field modification to a fire rated opening can potentially impact the fire rating of the opening, and Yale Locks & Hardware makes no representations or warranties concerning what such impact may be in any specific situation. When retrofitting any portion of an existing fire rated opening, or specifying and installing a new fire-rated opening, please consult with a code specialist or local code official (Authority Having Jurisdiction) to ensure compliance with all applicable codes and ratings.

Door Thickness	Adjustable for doors 1-3/8" (35mm) to 2" (51mm). Factory preset to 1-3/4" (44mm)
Backset	2-3/4" (70mm) standard
Latchbolt	1/2" (13mm) throw, deadlocking or plain, supplied standard
Strike	1-1/4" (32mm) curved lip ANSI 497 supplied standard, T-Strike optional. All strikes available with optional lip lengths and wrought boxes.
Installation	ANSI/BHMA A156.115 (-W)
ANSI/BHMA	Certified ANSI/BHMA A156.2, Series 4000 Grade 1
Finishes	605, 613E, 630
Warranty	10 year



How To Order



From this outline select the Model Number for the Yale® 5400CK Series locksets you require.

Design	Function	Cylinder	Latch	Strike	Finish	Keying Level
See page 6	See page 5	See page 7	See page 8	See page 9	See page 2	Highest Keying Level: "Level One" - KA or KD "Level Two" - MK "Level Three" - GM "Level Four" - GGM

Ordering Example

Quantity	Design	Function	Cylinder	Latch	Strike	Finish	Keying Level
100	CA	5407CK	1803-54K	694A	497	630	MK

Packaging

Each box has a strike, paper template, combination wood and machine screws and easy-to-follow instructions. Cylinder functions are supplied with two keys and furnished right hand unless otherwise specified. Each case contains spanner wrenches for use in installing locksets. There are ten unit cartons to a master carton or case.

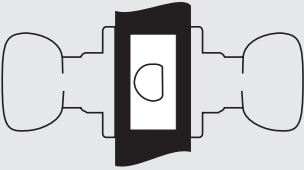
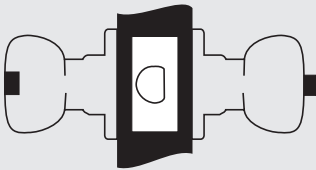
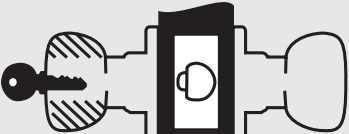
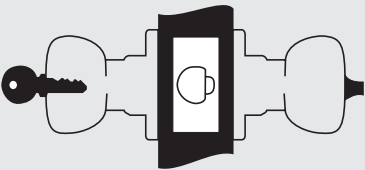
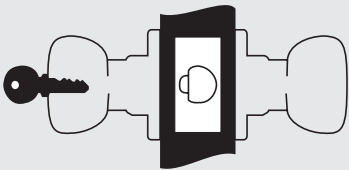
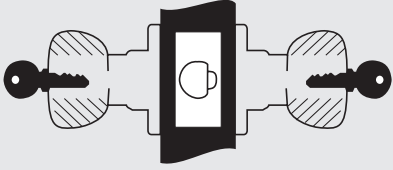
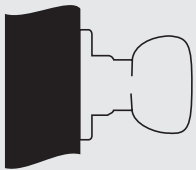

5401CK (F75)	5402CK (F76A)	5405CK (F86)
<p>Passage or Closet Latch</p> <ul style="list-style-type: none"> For doors that do not require locking. Either knob operates latchbolt at all times.  <p style="text-align: center;">Outside Inside</p>	<p>Privacy, Bedroom or Bath Lock</p> <ul style="list-style-type: none"> For lavatory or other privacy doors. Either knob operates latchbolt unless outside knob is locked by push-button inside. Button automatically released when inside knob is turned or door is closed. A coin inserted and turned in emergency slot will unlock door from outside. Inside knob always active.  <p style="text-align: center;">Outside Inside</p>	<p>Storeroom or Closet Lock</p> <ul style="list-style-type: none"> For use on storeroom, utility, exit doors. Deadlocking latchbolt. Latchbolt operated by knob inside, key in outside knob. Outside knob always rigid. Inside knob always active.  <p style="text-align: center;">Outside Inside</p>
5407CK (F109)	5408CK (F84)	5430CK (F87)
<p>Entry Lock</p> <ul style="list-style-type: none"> For entrance, general home or office doors. Deadlocking latchbolt. Either knob operates latchbolt (except when outside knob is locked from inside). Pushing turn button in inside knob locks outside knob (automatically releases when inside knob is turned or key is rotated in locked outside knob). Outside knob may be retained in locked position by pushing and rotating turn button 90° clockwise to a horizontal position; not released until turn button is manually returned to the vertical position. Latchbolt is operated by key in outside knob or by rotating inside knob. Inside knob always active.  <p style="text-align: center;">Outside Inside</p>	<p>Classroom Lock</p> <ul style="list-style-type: none"> For classroom or utility room doors. Deadlocking latchbolt. Either knob operates latchbolt (except when outside knob is locked by key). Inside knob is always active. Key releases outside knob.  <p style="text-align: center;">Outside Inside</p>	<p>Utility, Asylum or Institutional Lock</p> <ul style="list-style-type: none"> Latchbolt operated by key in knob from either side. Deadlocking latchbolt. Both knobs always rigid.  <p style="text-align: center;">Outside Inside</p>
5455CK		
<p>Dummy Trim</p> <ul style="list-style-type: none"> For non-operational knobs used for decorative trim.  <p style="text-align: center;">Outside Inside</p>		

Trim Design



Carolina CA

Knob: Heavy wrought brass or stainless steel

Rose: Heavy wrought brass or stainless steel

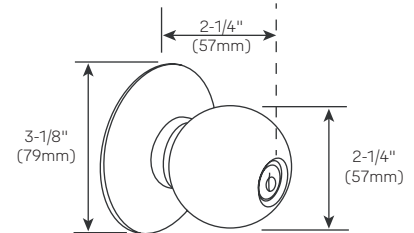

Cylinders



Cylinder Options

The following selection guide indicates the correct cylinder for each locking segment.

Lockset Series: 5400CK		Types of Cylinder Mechanisms					
		Conventional		Protected Keyway		Security	
Cylinder Types	Fixed Core	6-pin	7-pin	6-pin	7-pin	6-pin	7-pin
	Key-In-Knob	1803-54K	N/A	K403-54K	N/A	5803-54K	N/A
	Interchangeable Core						
SFIC	A600	A600	K600	K600	N/A	N/A	

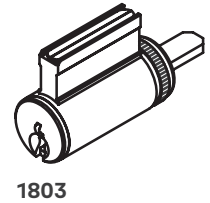

Refer to Yale® KeyMark® and/or Cylinders and Keys Catalog sections for all details and how to order examples.

Yale® Keymark®

For those applications requiring protected key control, Yale® KeyMark® cylinders guard against unauthorized key duplication. The Yale KeyMark Security Leg® keyway feature increases resistance against picking and impressioning and can easily retrofit into existing systems. For further details and availability, refer to the separate Yale KeyMark catalog.

Security Cylinders

Security cylinders contain two independent locking mechanisms. The first is a traditional 6 or 7-pin tumbler mechanism with spool drivers for greatly increased picking resistance.

The second is an innovative 5-tumbler rotating disc mechanism with sidebar engagement. The rotating discs are spring loaded and block the bottom of the keyway.

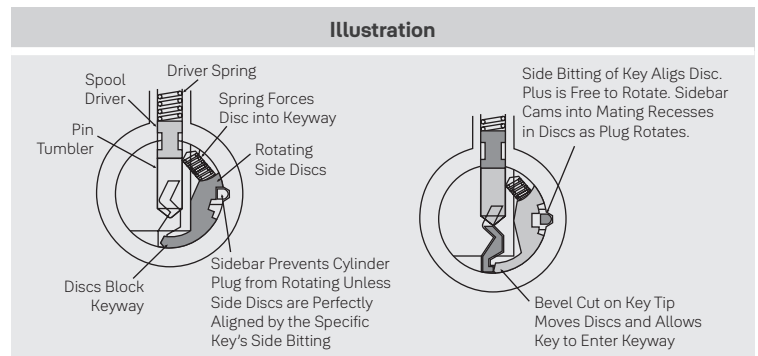

Other Cylinder Options

	Description	Model Number or Prefix	Number of Pins
	Best® Keyway Cylinder. Available keyed random, master keyed or uncombined. Specify keyway A, B, C, D, E, F, G, H, J, K, L or M.	A600	6 or 7
	Schlage® "C" Keyway. Available 0-bitted or keyed random.	2803-54K	6
	Corbin Russwin L4 Keyway Cylinder. Available keyed random.	3803-54K x L4	6
	Corbin 60 Keyway Cylinder. Available keyed random.	3803-54K x 60	6
	Russwin D1 Keyway Cylinder. Available keyed random.	3803-54K x D1	6
	Sargent® LA Keyway Cylinder. Available keyed random.	3803-54K x LA	6
	Schlage® E Keyway Cylinder. Available keyed random.	3803-54KL x E	6
	Knob accepting all SFIC.	B (i.e. B-CA)	6 or 7

Latchbolts



Plain Latchbolts

Model No. 693A supplied standard with all 5400CK series locksets without locking function. Standard plain latchbolt has a 2-1/4" (57mm) x 1-1/8" (29mm) universal front with a 2-3/4" (70mm) backset and a 1/2" (13mm) bolt throw.

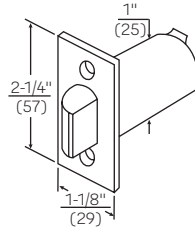

Model No.	Front	Backset	Throw	Front Width	Latch Diameter
693A	Universal	2-3/4" (70mm)	1/2" (13mm)	1-1/8" (29mm)	1" (25mm)

Deadlocking Latchbolts

Deadlocking latchbolt Model No. 694A supplied standard with all 5400CK series locksets with locking function. Standard deadlocking latchbolt has a 2-1/4" (57mm) x 1-1/8" (29mm) universal front with a 2-3/4" (70mm) backset and a 1/2" (13mm) bolt throw.

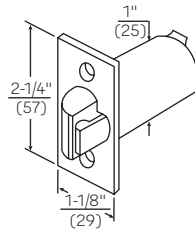

Model No.	Front	Backset	Throw	Front Width	Latch Diameter
694A	Universal	2-3/4" (70mm)	1/2" (13mm)	1-1/8" (29mm)	1" (25mm)

Attaching Screws

(Not regularly supplied when latchbolts ordered separately).

- **For all latchbolts**
#8-8-32 x 3/4" (19mm) Phillips flat head combination wood and machine screws
P/N 81-2022-0416*
- **Hollow Metal Doors**
#8 - 32 x 1" (25mm) Phillips flat head machine screw
P/N 81-0022-0420*
- **Screw Pack**
Includes the following:
2 each 5M-.8 x 31 Phillips Flat Machine Screws
2 each 6M x 20 Combination Screws
2 each 4M x 20 Combination Screws
P/N 14-5400-0608*

*Specify finish required.

Strikes



Yale® 5400CK locks are available with a variety of strike options. All strikes are located on the same vertical and horizontal center lines as the latchbolt. Some strikes are available in special lip lengths to accommodate varying thickness of doors and frames. To determine the proper length of the lip, measure from the center line of the strike to the edge of the jamb, accounting for any interfering trim (i.e. wood molding) and then add 1/4" (6mm) for curved lip. All strikes are reversible. Strikes are fabricated of either brass, bronze or stainless steel, depending on the lockset trim finish. When ordering strikes separately, specify the finish required.

<p>Model No. 497 ANSI Strike (Standard) 1-1/4" supplied standard. 1-1/8", 1-1/2", and 1-3/4" lip lengths available by separate order. For door and frames with ANSI/BHMA A156.115 preparations.</p>	<p>Model No. 371 T-Strike (Optional) 1-1/4" curved lip supplied standard. 1", 1-1/2", 1-3/4", and 2" curved lip lengths available by separate order. Wrought strike box supplied.</p>	<p>Model No. 497B Blank ANSI Strike (Optional) Available to special order. Installed in frame with standard ANSI/BHMA A156.115 preparation to replace the strike when the lockset has been removed from the door.</p>	<p>Model No. 202 Strike Box for ANSI Strike (Optional) Specify 497 x 202</p>

Attaching Screws

(Not regularly supplied when strikes ordered separately).

For Model No. 371 strike

#8-8-32 x 3/4" (19mm) Phillips flat head combination wood and machine screw P/N-81-2012-0416.

For Model No. 497 strike and 497B plate

#12-12-24 x 1" (25mm) Phillips flat head combination wood and machine screw P/N-81-2012-0620.

Note: When ordering strike plates or attaching screws individually, specify the finish required; i.e. 497 x 202 x 630; #81-2012-0620 x 630.

Specifications



Sample Specification

All locksets shall be 5400CK Series Grade 1 cylindrical knob locksets as provided by Yale Locks & Hardware.

Lockset mechanisms are to be constructed of heavy-gauge cold-rolled steel, zinc plated chromate to protect against rust and corrosion. Locksets shall be adjustable to fit doors between 1-3/8" (35mm) to 2" (51mm) thick.

Locksets shall be reversible for either right hand or left hand doors and be easily installed with out the use of any special tools. They shall be installed in a 2-1/8" face bore and a 1" hole in the edge of the door.

Outside knob on keyed locksets shall be removable only when the designated key is in the cylinder.

Locksets shall have the capability of accepting 6-pin standard component cylinders, security cylinders and protected keyway cylinders to provide expansion capacity for large masterkey systems. Small format interchangeable core is also available.

Latchbolts shall be stainless steel and have a standard 1/2" throw.

Locksets shall carry a 10-year mechanical warranty.

Locksets shall comply with the following:

- UL/cUL up to and including 3 hours fire rating
- ANSI/BHMA A156.2 series 4000 Grade 1
- ANSI/BHMA A156.115 or A156.115-W preparation





Trusted every day

Phone

1-855-557-5078

Customer Service Email

customerservice.yale@assaabloy.com

Technical Product Support Email

techsupport.yale@assaabloy.com

Order Entry Email

orders.yaleus@assaabloy.com

Fax

1-800-338-0965

Website

www.yalecommercial.com

Contact Us

U.S.A.

Yale Locks & Hardware

Address: 225 Episcopal Road

Berlin, CT 06037-4004

Tel: 1-800-438-1951

Fax: 1-800-338-0965

yalecommercial.com

Canada:

ASSA ABLOY Door Security Solutions Canada

Address: 160 Four Valley Drive

Vaughan, Ontario L4K 4T9

Tel: 1-800-461-3007

Fax: 1-800-461-8989

assaabloydss.ca

International:

ASSA ABLOY Americas International

Tel: 1-905-821-7775

Fax: 1-905-821-1429

assaabloyai.com

THE YALE BRAND, with its unparalleled global reach and range of products, reassures more people in more countries than any other consumer locking solution.

THE ASSA ABLOY GROUP is the world's leading manufacturer and supplier of locking solutions, dedicated to satisfying end-user needs for security, safety and convenience.

Yale Commercial is a business associated with ASSA ABLOY Access and Egress Hardware Group, Inc., an ASSA ABLOY Group company. Copyright © 2015-2021, ASSA ABLOY Access and Egress Hardware Group, Inc. All rights reserved. Reproduction in whole or in part without the express written permission of ASSA ABLOY Access and Egress Hardware Group, Inc. is prohibited. Patent pending and/or patent www.assaabloydss.com/patents.



4300LN Series

Grade 2 Tubular Lever Locks

the engineer's choice

introduction

An economical, light/medium duty Grade 2 lever lockset which provides an outstanding combination of value and performance. It's the ideal lever lockset for light commercial and heavy-duty residential applications, which typically include:

- Interior offices
- Closets
- Multi-family housing
- Hotels
- Restaurants
- Retail complexes

installation

4300LN Series tubular locksets conform to ANSI/BHMA Specifications A156.115 which cover hardware preparations for steel doors and steel frames and A156.115-W which cover hardware preparations for wood doors with wood or steel frames.

warranty

The 4300LN Series tubular lever lock carries a one-year warranty.

ANSI/BHMA

Certified ANSI/BHMA A156.2, Series 4000 Grade 2.



A.D.A.

The 4300LN Series meets accessibility guidelines of the Americans with Disabilities Act and the requirements of the Uniform Federal Accessibility Standards and ANSI 117.1, all requiring ease of accessibility for the handicapped.

cylinders

Furnished standard with Yale® 1812 6-pin cylinder. Optional Yale® KeyMark® fixed core.

latches

1/2" bolt projection.

fire listings

4300 Series locksets (including fire cup) are UL listed for use on fire doors for up to 90 minutes.

Note: Any retrofit or other field modification to a fire rated opening can potentially impact the fire rating of the opening, and Yale Locks & Hardware makes no representations or warranties concerning what such impact may be in any specific situation. When retrofitting any portion of an existing fire rated opening, or specifying and installing a new fire-rated opening, please consult with a code specialist or local code official (Authority Having Jurisdiction) to ensure compliance with all applicable codes and ratings.

door thickness

Locksets are adjustable for doors 1-3/8" to 1-3/4".

backset

The 4300LN Series is available with 2-3/8" or 2-3/4" deadlocking latchbolt.

handing

RH or LH must be specified on Madrid 4305LN, 4308LN, 4328LN, and 4355LN.

4301LN, 4302LN and 4307LN are furnished as RH. They can be changed to LH by reversing inside and outside levers.

contents

Introduction.....	2
Features.....	2
Lever Designs.....	3
Functions.....	4
Cylinders.....	5
Latchbolts.....	6
Strikes.....	7
Ordering Information.....	8
Sample Specification.....	9

finishes

ANSI/BHMA Code	Finish Description
605	Bright Brass, Clear Coated
606	Satin Brass, Clear Coated
609	Satin Brass, Blackened, Satin Relieved, Clear Coated
613*	Dark Oxidized Satin Bronze, Oil Rubbed
619	Satin Nickel Plated, Clear Coated
625	Bright Chrome Plated
626	Satin Chrome Plated

* Simulated painted finish meeting ANSI/BHMA standards for wear and durability.

split finishes

605x625, 605x626, 606x625 and 606x626 are available in 4302LN Privacy function only.

strikes

T-strike standard (2-3/4" x 1-1/8"). Also available in ANSI and full lip configurations.

lever designs

Augusta AU

Lever: Cast Zinc
Rose: Cold Forged Brass

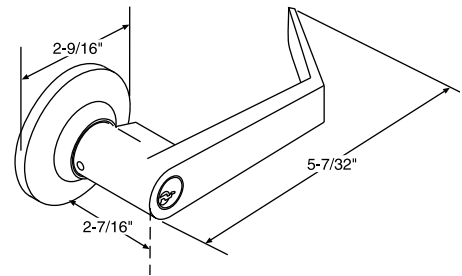

Madrid MA

Lever: Cast Zinc
Rose: Cold Forged Brass

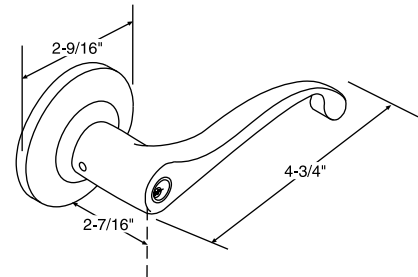

Monroe MO

Lever: Cast Zinc
Rose: Cold Forged Brass

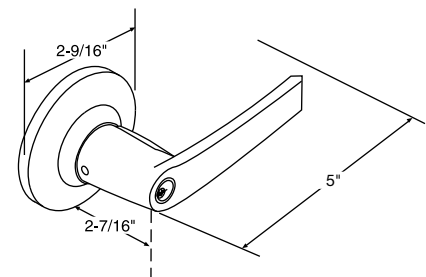

Pacific Beach PB

Lever: Cast Zinc
Rose: Cold Forged Brass

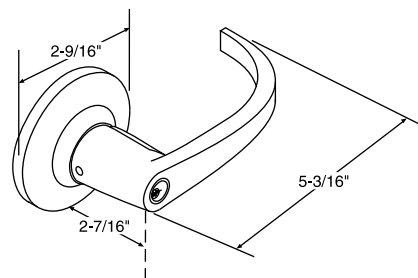

functions

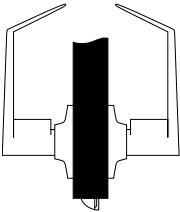
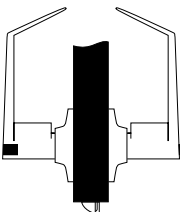
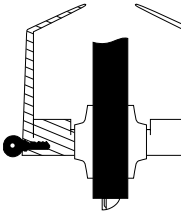
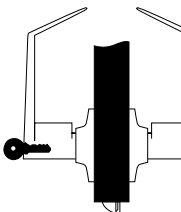
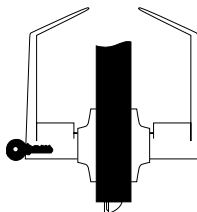
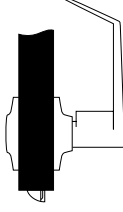
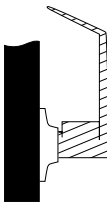
<p style="text-align: center;">4301LN (F75)</p> <p>Passage or Closet Latch</p> <ul style="list-style-type: none"> • For doors that do not require locking. • Either lever operates latchbolt at all times. 	<p style="text-align: center;">4302LN (F76B)</p> <p>Privacy, Bedroom or Bath Lock</p> <ul style="list-style-type: none"> • For lavatory or other privacy doors. • Either lever operates latchbolt unless outside lever is locked by pushbutton inside. • Button automatically releases when inside lever is turned, but does not automatically release when door is closed. • Emergency release in outside lever. • Inside lever always active. 	<p style="text-align: center;">4305LN (F86)</p> <p>Storeroom or Closet Lock</p> <ul style="list-style-type: none"> • For use on storeroom, utility, exit doors. • Deadlocking latchbolt. • Latchbolt operated by lever inside, key in outside lever. • Outside lever always locked. Key unlocks lever. Lever retracts latchbolt. 	<p style="text-align: center;">4307LN (F109)</p> <p>Entry Lock</p> <ul style="list-style-type: none"> • For entrance, general home or office doors. • Deadlocking latchbolt. • Either lever operates latchbolt (except when outside lever is locked from inside). • Outside lever retained in locked position by rotating turn button 90° to a horizontal position; not released until turn button is manually returned to the vertical position. • Key outside unlocks turn button inside. • Latchbolt is operated by rotating inside lever. • Inside lever always active. 
<p style="text-align: center;">4308LN (F84)</p> <p>Classroom Lock</p> <ul style="list-style-type: none"> • For classroom or utility room doors. • Deadlocking latchbolt. • Either lever operates latchbolt (except when outside lever is locked by key). • Inside lever always active. 	<p style="text-align: center;">4328LN (F111)</p> <p>Communicating Passage Lock</p> <ul style="list-style-type: none"> • For twin communicating or exit doors where one side operation is required. • Also when space is limited between door and switch panel. • Deadlocking latchbolt. • One lever operation. • Blank rose. • Should be used only where rooms have more than one entrance. 	<p style="text-align: center;">4355LN</p> <p>Dummy Trim</p> <ul style="list-style-type: none"> • Lever acts as pull only; no operation. 	

cylinders

cylinder options

The following selection guide indicates the correct cylinder for each locking segment.

Lockset Series: 4300LN		Types of Cylinder Mechanisms								
		Conventional		Protected Keyway		Security		High Security		
Cylinder Types	Fixed Core	6-pin	7-pin	6-pin	7-pin	6-pin	7-pin	6-pin	7-pin	
	Key-In-Lever	1812	N/A	K404	N/A	5812	N/A	N/A	N/A	
	Interchangeable Core									
	LFIC	N/A	N/A	N/A	N/A	N/A	N/A	N/A	N/A	
SFIC	N/A	N/A	N/A	N/A	N/A	N/A	N/A	N/A		

Refer to Yale® KeyMark® and/or Cylinders and Keys Catalog sections for all details and how-to-order examples.

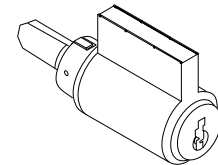

1812

Yale® KeyMark®

For those applications requiring protected key control, Yale® KeyMark® cylinders guard against unauthorized key duplication. The *Yale KeyMark Security Leg®* keyway feature increases resistance against picking and impressing and can easily retrofit into existing systems. For further details and availability, refer to the separate *Yale KeyMark* catalog.

security cylinders

Security cylinders contain two independent locking mechanisms. The first is a traditional 6- or 7-pin tumbler mechanism with spool drivers for greatly increased picking resistance.

The second is an innovative 5-tumbler rotating disc mechanism with sidebar engagement. The rotating discs are spring loaded and block the bottom of the keyway.

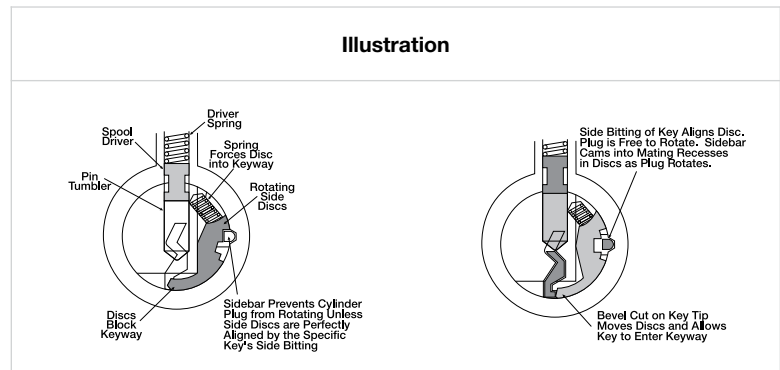

other manufacturers' keyway cylinders

Illustration	Description	Model Number	Number of Pins
	Schlage® C Keyway Cylinder. Available "0" bitted or keyed random.	2812	6

latchbolts

UL latches

Model No. 280DN supplied standard with all 4300LN series locksets. Model No. 280DN latchbolt has a 2-1/4" x 1-1/8" front with a 2-3/4" backset and a 1/2" bolt throw. Optional latchbolts available to special order.

Model No.	Front	Backset	Throw	Front Width	Latch Diameter
280N	Square	2-3/8" (60mm)	1/2" (13mm)	1" (25mm)	7/8" (22mm)
280RN	Round	2-3/8" (60mm)	1/2" (13mm)	1" (25mm)	7/8" (22mm)
280DN	Square	2-3/4" (70mm)	1/2" (13mm)	1-1/8" (29mm)	7/8" (22mm)

All 4300LN latches are deadlocking with a flat, square corner front.

Note: Locksets in 605, 606 and 609 finish are supplied with a 605 latch.

Locksets in 613 finish are supplied with a 613 latch. Locksets in 619, 625, and 626 finish are supplied with a 626 latch.

All latches have a 7/8" diameter. A 1/8" sleeve (p/n 14-0378-9001-999) is included to accommodate 1" door preps.

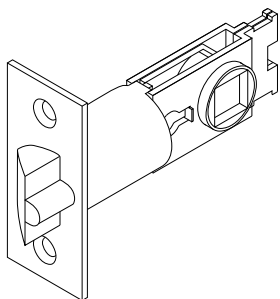

UL fire cup

Model Number: 10C

Supplied Standard with all 4300LN's.
Failure to use invalidates UL fire listing.

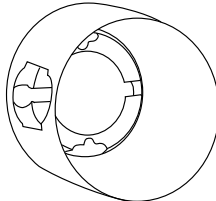

screw pack

Model Number: SP100

Supplied Standard with wood-machine screws combination.

strikes

Yale® 4300LN locks are available with a variety of strike options. All strikes are located on the same vertical and horizontal center lines as the latchbolt. Some strikes are available in a variety of lip lengths to accommodate varying thickness of doors and frames. To determine the proper length of the lip, measure from the center line of the strike to the edge of the jamb, accounting for any interfering trim (i.e. wood molding) and then add 1/4" (6mm) for curved lip. All strikes are reversible. Strikes are fabricated of either brass or stainless steel, depending on the lockset trim finish. When ordering strikes separately, specify the finish required.

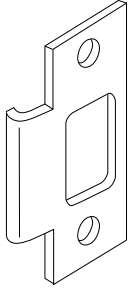
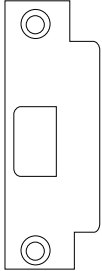
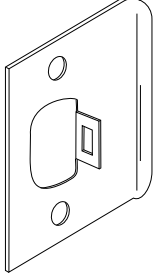
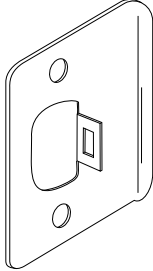
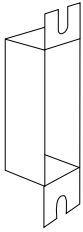
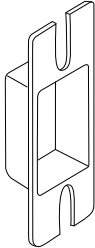
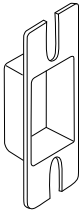
 <p>Model No. 271 T-Strike (Standard) 1-1/4" Lip. Supplied standard with 4300LN Series Locksets.</p>	 <p>Model No. 497 ANSI Strike (Optional) For door and frames with ANSI/BHMA A156.115 and A156.115-W preparations.</p>	 <p>Model No. 20S Full Lip Strike (Optional) Square corner with full lip anti-rattle tab.</p>	 <p>Model No. 21S Full Lip Strike (Optional) 1/4" Round Corner Radius Similar in dimensions and function to the 20S Strike but with radius corners for easy mortising by power tools. Anti-rattle tab.</p>
 <p>Model No. 202 Strike Box for ANSI Strike (Optional) Specify 497 x 202</p>	 <p>Model No. 301 Strike Box for 271 Strike</p>	 <p>Model No. 302 Strike Box for 20S and 21S Strikes</p>	

attaching screws

For Model Nos. 271, 20S, and 21S Strikes
#8-8-32 x 3/4" (19mm) Phillips/flat head combination wood and machine screws. Part No. SP100

For Model No. 497 ANSI Strike
#12-12-24 x 1" Phillips/flat head combination wood and machine screws. Part No. 81-2012-0620

ordering information

From this outline select the Model Number for the Yale® 4300LN Series Lockset you require.

Design	Function	Latch	Strike	Cylinder	Door Thickness	Finish
See Page 3	See Page 4	See Page 6	See Page 7	See Page 5	See Page 2	See Page 2

ordering example

Quantity	Design	Function	Latch	Strike	Cylinder	Door Thickness	Finish
100	AU	4307LN	280N	271	1812	1-3/4"	626

packing

Each box has a strike, firecup, paper template, combination wood and machine screws and easy-to-follow instructions. Cylinder functions supplied with two keys. Twelve shelf boxes to a case.

sample specification

All locksets shall be 4300LN Series Grade 2 tubular lever locksets.

Locks shall have an interlocking tubular chassis and latchbolt. Chassis mounting screws shall be accessible only when the levers and roses are removed.

The latchbolt shall have a 1/2" (13mm) throw and shall include a deadlocking feature to inhibit manipulation when the door is locked.

Locksets and latchbolts shall be reversible for ease of installation.

All locksets shall be adjustable for 1-3/8" (35mm) and 1-3/4" (44mm) door thickness. Levers shall operate independently and shall have inside and outside lever return springs to prevent lever sag.

Lever handles shall be a minimum of 4-3/4" (121mm) in length and shall provide a minimum of 2-1/8" (54mm) clearance from surface of door to the inside of the lever at the midpoint.

Outside levers on keyed locksets shall be removable only when the designated key is in the cylinder.

Locksets shall be furnished with two keys. All cylinder plugs shall be brass and furnished with 6-pin chambers for master keying capabilities.

Cylinders shall be easily changed by removing the lever without disassembling the lockset.

Certification:

UL 1-1/2 Hour Fire Rating

ANSI/BHMA A156.2 Series 4000, Grade 2

ANSI A117.1 Accessibility Code

All locksets shall carry a one-year warranty.

online literature and templates

For the latest information on Yale Locks & Hardware products, visit our website at: www.yalelocks.com

Click on the "Product Information" button to find:

- Catalogs
- Parts manuals
- Templates
- Specifications
- Installation instructions

Yale® customers can click on the ebusiness symbol  on the website to register for an ebusiness account to:

- Check the status of orders
 - Check availability of QuickShip items
 - Track your order and confirm delivery
 - Receive email notification of template changes
- And More...

Or contact us at:

U.S.A.

Yale Locks & Hardware

Address: 225 Episcopal Road, Berlin, CT 06037-4004

Tel: 1-800-438-1951 • Fax: 1-800-338-0965 • www.yalelocks.com

Canada:

ASSA ABLOY Door Security Solutions Canada

Address: 160 Four Valley Drive, Vaughan, Ontario L4K 4T9

Tel: 1-800-461-3007 • Fax: 1-800-461-8989 • www.assaabloy.ca

International:

ASSA ABLOY Americas International

Tel: 1-905-821-7775 • Fax: 1-905-821-1429 • www.assaabloyai.com

Yale Locks & Hardware is a division of Yale Security Inc., an ASSA ABLOY Group company.

Yale® is a registered trademark of Yale Security Inc., an ASSA ABLOY Group company. KeyMark® and Security Leg® are registered trademarks of Medeco Security Locks, Inc., an ASSA ABLOY Group company. Other products' brand names may be trademarks or registered trademarks of their respective owners and are mentioned for reference purposes only. These materials are protected under U.S. copyright laws. All contents current at time of publication. Yale Security Inc. reserves the right to change availability of any item in this catalog, its design, construction, and/or its materials. Copyright © 2001-2016, Yale Security Inc., an ASSA ABLOY Group company. All rights reserved. Reproduction in whole or in part without the express written permission of Yale Security Inc., an ASSA ABLOY Group company is prohibited.

YALE, with its unique global reach and range of products, is the world's favorite lock.

ASSA ABLOY is the global leader in door opening solutions, dedicated to satisfying end-user needs for security, safety and convenience.

42122-11/16R



RL Series Tubular Locks



Table of Contents



Contents

Benefits & Features.....	3
How to Order.....	4
Finishes.....	5
Lever Trim.....	6-10
Rose Options.....	11
Functions.....	12
Latchbolts.....	13
Strikes.....	14
Exploded View.....	15
Sample Specification.....	16
Technical Specifications & Listings.....	17

RL Series Tubular Locks

For applications that require beautiful modern aesthetics, Yale RL Series Tubular Locks are specially designed for use with the Yale Reflections® decorative lever collection. Engineered with the trusted quality of Yale and with ease of installation in mind, the RL Series exceeds the expectations of architects and design professionals in the interior applications of any hospitality, multi-family, and mixed-use facility.

At the place where form meets function, Yale Works for YouSM.

Benefits & Features



Benefits

- **Beautiful design:** Well-suited to any interior application that requires attractive, modern aesthetics
- **Suiting options:** Reflections® levers can be suited on door hardware throughout your facility, allowing for design continuity
- **Versatile installation:** Adjustable rose accommodates a variety of door thicknesses
- **Secure:** Quality security from a brand trusted for over 170 years

Features

- Available in 30 lever designs across 13 high-quality architectural finishes
- Offered in a range of function options for any interior application, including passage, privacy, dummy trims and more
- ADA compliant for ease of accessibility



Specifications

Backset	2-3/4" (70mm) standard, 2-3/8" (60mm) optional
Door Thickness	Standard for doors 1-3/8" (35mm) to 1-3/4" (44mm). Optional 1-7/8" (48mm) to 2" (51mm).
Handing	Non-handed
Latchbolt	Brass with 1/2" (13mm) projection. 2-3/4" (70mm) backset standard, see page 13 for additional options.
Strike	T-Strike 2-3/4" x 1-1/8" x 1-1/4" (70mm x 29mm x 32mm) lip to center supplied standard, see page 14 for additional options.
Door Prep	Conform to ANSI/BHMA A156.115 amd A156.115-W for steel and wood doors.
UL/cUL	Listed for use on fire doors up to and including 3 hours.
Warranty	1 year



How to Order

Quantity	Lever Design	Rose Design	Function	Hand	Latch	Strike	Door Thickness	Finish
	See pages 6-10	See page 11	See page 12	Specify RH or LH	RLP34(A) latchbolt supplied standard, see page 13 for additional options	371 strike supplied standard, see page 14 for additional options	1-3/8" to 1-3/4" standard Optional 1-7/8" to 2"	See page 5

Build Your Order String

Quantity	Lever Design	Rose Design	Function	Hand	Latch	Strike	Door Thickness	Finish
Example:	TM	R4	RL201	RH	RLP34	371	1-3/4"	BSP

Finishes



ANSI/BHMA Code Finish Description				
605 Bright Brass, Clear Coated	606 Satin Brass, Clear Coated	611 Bright Bronze, Clear Coated	612 Satin Bronze, Clear Coated	613E Dark Oxidized Satin Bronze - equivalent
618 Bright Nickel Plated, Clear Coated	619 Satin Nickel Plated, Clear Coated	625 Bright Chrome Plated	626 Satin Chrome Plated ¹	629 Bright Stainless Steel
630 Satin Stainless Steel	BSP Black Suede Powder Coat	WSP White Suede Powder Coat		

1. Finish available with MicroShield® antimicrobial coating. Add YMS suffix to order Microshield antimicrobial coating.

613 and 722 finishes are available through Special Application Request only. The form is available on the Yale extranet and should be submitted to TPS.

MicroShield coating may vary finish color from architectural standards. MicroShield is not intended as a substitute for traditional infection control programs such as hand hygiene or use of disinfectants. Coated products must still be cleaned to ensure the surfaces will be free of destructive microbes. Yale makes no representations or warranties, express or implied, as to the efficacy of MicroShield.

Lever Trim





Hudson

<p>TB</p>			
<p>UB</p>			
<p>TC</p>			
<p>UC</p>			
<p>TD</p>			

Lever Trim

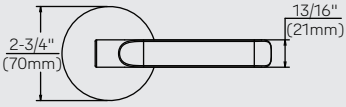
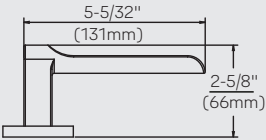

Spree

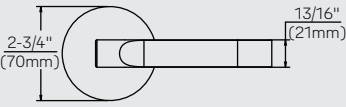
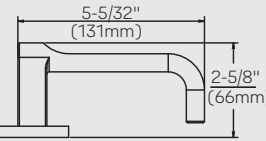
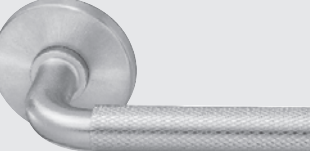
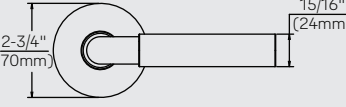
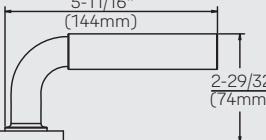
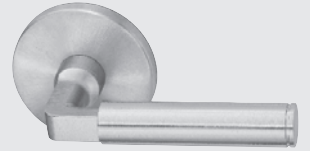
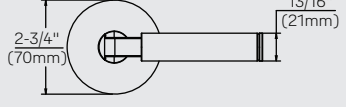
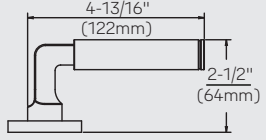
<p>RS</p>			
<p>RT</p>			
<p>RU</p>			
<p>RV</p>			

Lever Trim



Seine









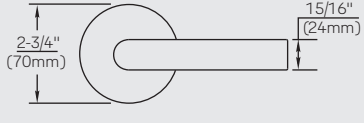
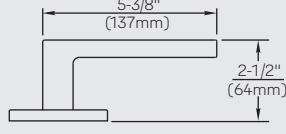

TE			
TG*			
TI			
TJ*			
TK*			
TO*			

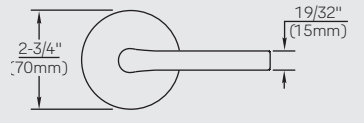
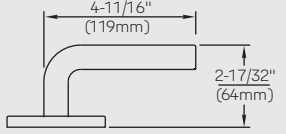
*Handed levers.

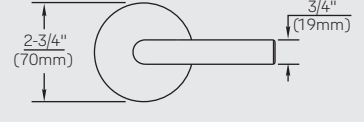
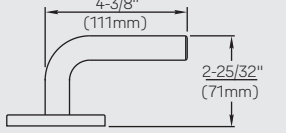
Lever Trim

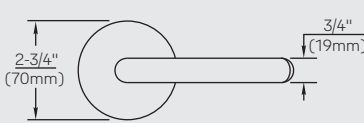
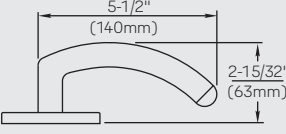

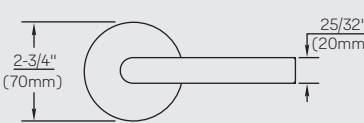
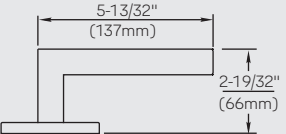
Thames

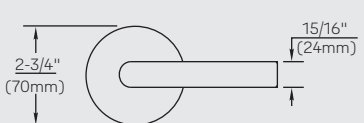
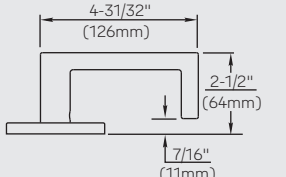
<p>TM</p>			
<p>TN</p>			
<p>TP</p>			
<p>TR</p>			
<p>TS</p>			
<p>TQ</p>			

Lever Trim



Victoria

TT*			
TU*			
TV*			
TW*			
UW*			
TX*			
UX*			
TY*			
TZ*			

*Handed levers.

Rose Options

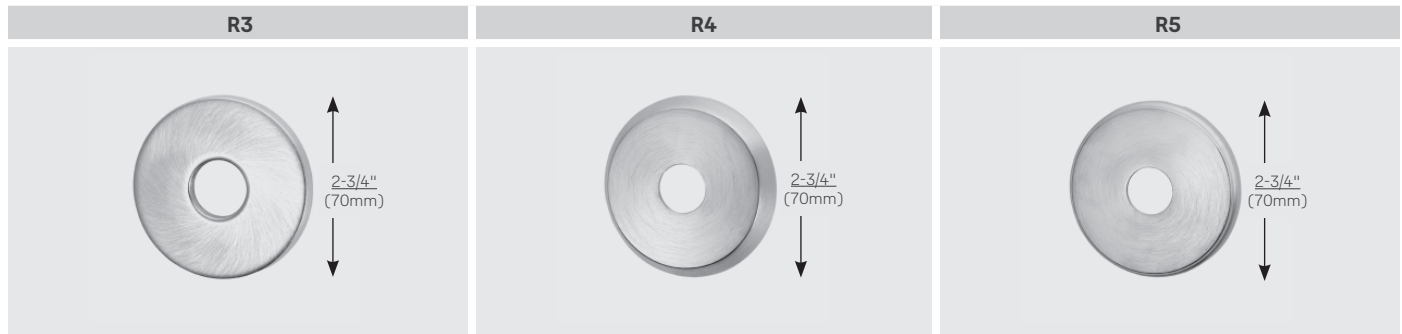

Functions

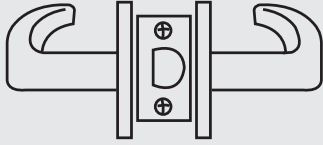
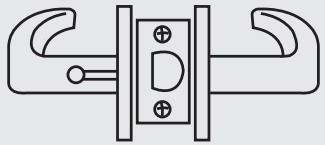
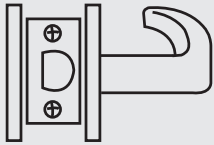
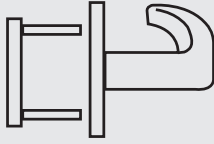
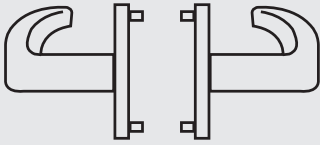
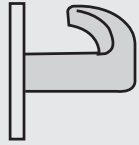

<p style="text-align: center;">RL201</p>	<p style="text-align: center;">RL202</p>
<p>Passage or Closet Latch</p> <ul style="list-style-type: none"> • For doors that do not require locking. • Either lever operates latchbolt at all times. • Ideal for closets and bedrooms. 	<p>Privacy Bedroom or Bath Lock</p> <ul style="list-style-type: none"> • Either lever operates latchbolt unless outside lever is locked by pushbutton inside. • Button automatically releases when inside lever is turned or door is closed. • Emergency release outside. • Inside lever always active. • Ideal for lavatories and home offices. 
<p style="text-align: center;">RL228</p>	<p style="text-align: center;">RL255</p>
<p>Communicating Passage or Exit Latch</p> <ul style="list-style-type: none"> • For twin communicating or exit doors where one side operation is required. • Use where space is limited. • One lever operation. • Blank rose. • Should be used only where rooms have more than one entrance. 	<p>Dummy Trim</p> <ul style="list-style-type: none"> • Non-operational lever used for decorative trim. • No latchbolt. • Ideal for pantries. 
<p style="text-align: center;">RL255D</p>	<p style="text-align: center;">RL255S</p>
<p>Double Dummy Trim</p> <ul style="list-style-type: none"> • Non-operational levers used for decorative trim. • No latchbolt. • Ideal for sliding doors. 	<p>Dummy Trim</p> <ul style="list-style-type: none"> • Non-operational lever used for decorative trim. • No latchbolt. • Surface mounted. • Ideal for pantries. 

Shaded lever denotes rigid lever.

Latchbolts



Model No. RLP34(A) supplied standard with all RL series locksets. Model No. RLP34(A) latchbolt has a 2-1/4" x 1-1/8" front with a 2-3/4" backset and a 1/2" bolt throw. Optional square and round corner latchbolts available to special order, see below.

Model Number	Function Used With	Front	Backset	Throw	"W" Front Width	Latch Diameter*
RLP38	RL202	Square	2-3/8" (60mm)	1/2" (13mm)	1" (25mm)	1" (25mm)
RLP38A	RL201 & RL228	Square	2-3/8" (60mm)	1/2" (13mm)	1" (25mm)	1" (25mm)
RLP34	RL202	Square	2-3/4" (70mm)	1/2" (13mm)	1-1/8" (29mm)	1" (25mm)
RLP34A	RL201 & RL228	Square	2-3/4" (70mm)	1/2" (13mm)	1-1/8" (29mm)	1" (25mm)

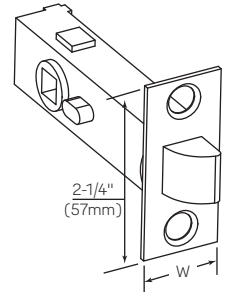

Model Number	Function Used With	Front	Backset	Throw	"W" Front Width	Latch Diameter*
RLPR38	RL202	Round	2-3/8" (60mm)	1/2" (13mm)	1" (25mm)	1" (25mm)
RLPR38A	RL201 & RL228	Round	2-3/8" (60mm)	1/2" (13mm)	1" (25mm)	1" (25mm)
RLPR34	RL202	Round	2-3/4" (70mm)	1/2" (13mm)	1-1/8" (29mm)	1" (25mm)
RLPR34A	RL201 & RL228	Round	2-3/4" (70mm)	1/2" (13mm)	1-1/8" (29mm)	1" (25mm)

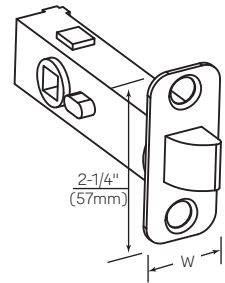

Strikes

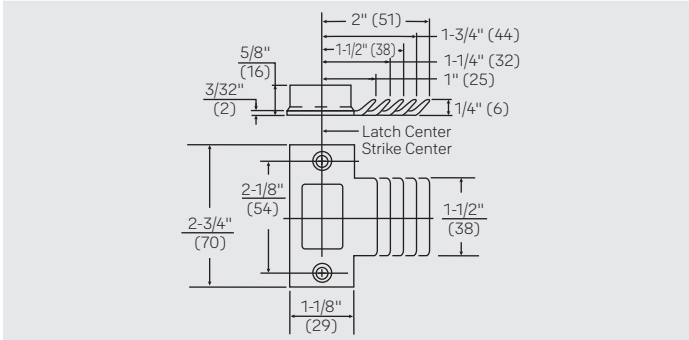

Standard Strike
 Model No. 371 x 1-1/4" lip supplied standard with RL Series locks. This strike will accommodate frames for 1-3/8" to 1-3/4" thick doors. Strikes with other lip dimensions shown are available to special order. All Model No. 371 strikes are supplied with wrought strike box Part No. 14-5301-1033.

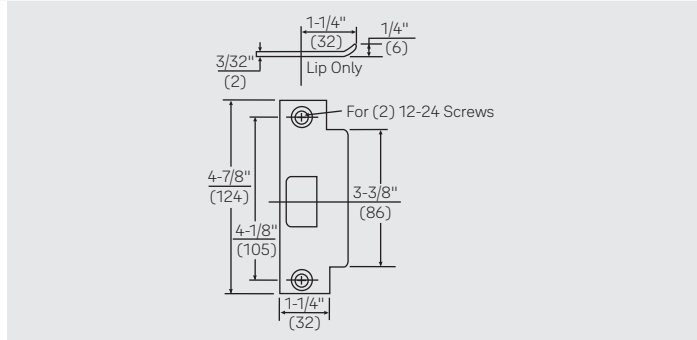

Optional 497 ANSI Strike
 For doors and frames with ANSI/BHMA A156.115 preparations. 1-1/4" supplied standard. 1-18", 1-1/2" and 1-3/4" lip lengths available by special order.

Note: dimensions shown inches (millimeters)

Exploded View

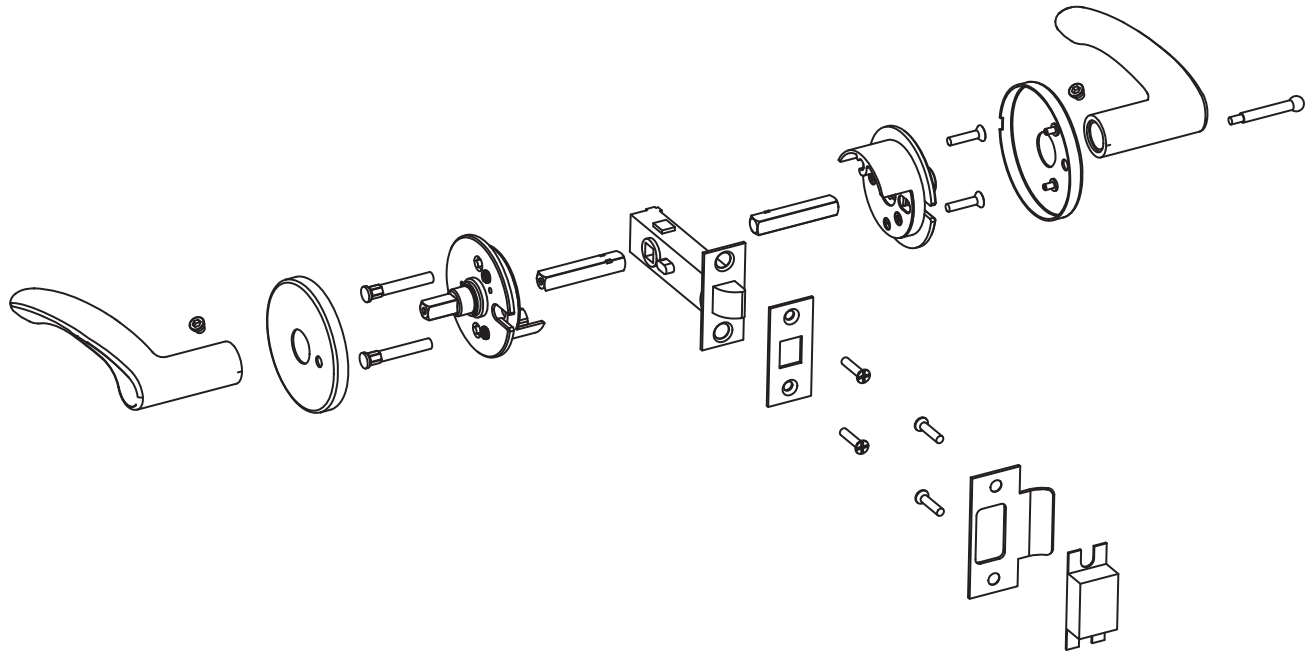



Sample Specification

All locks shall be RL Series Tubular as provided by Yale Locks & Hardware.

Locks shall have an interlocking tubular chassis and latchbolt. Chassis mounting screws shall be accessible only when the levers and roses are removed.

All locks shall mount in a standard ANSI/BHMA A156.115 door prep (2-1/8" diameter) without additional thru-bolt preps.

All locks and latchbolts shall be non-handed and reversible for ease of installation.

All locks shall have bi-directional lever operation and lever handles shall be a minimum of 4-1/4" (108mm) in length. All levers shall be made of solid material with no plastic fillers.

All locks shall be adjustable for 1-3/8" (35mm) and 1-3/4" (44mm) door thickness.

All locks shall have a standard 2-3/4" (70mm) backset and offered with optional 2-3/8" (60mm) backset.

All latchbolts shall have a 1/2" (13mm) throw.

All strikes shall be non-handed with a curved lip.

Certification:

ANSI A117.1 Accessibility Code

UL 3-hour Rating (Optional)

All locks shall carry a one-year warranty.

Technical Specifications and Listings



ADA



The RL Series lever designs meet accessibility guidelines of the Americans with Disabilities Act and the requirements of the Uniform Federal Accessibility Standards and ANSI A117.1, all requiring ease of accessibility.

Door Prep

RL Series Tubular locks conform to ANSI/BHMA specifications A156.115 which cover hardware preparations for steel doors and steel frames and A156.115-W which cover hardware preparations for wood doors with wood or steel frames.

Fire Listings

RL Series Tubular locks are available UL-cUL Listed for use on fire doors having a rating up to and including 3-hours. This option is available for RL201, RL202 and RL228 functions and can be ordered by suffixing "F" to the model number, i.e. RL201F.

Note: Any retrofit or other field modification to a fire rated opening can potentially impact the fire rating of the opening, and Yale Locks & Hardware makes no representations or warranties concerning what such impact may be in any specific situation. When retrofitting any portion of an existing fire rated opening, or specifying and installing a new fire-rated opening, please consult with a code specialist or local code official (Authority Having Jurisdiction) to ensure compliance with all applicable codes and ratings.

Warranty

RL Series Tubular locks carry a one-year warranty.



Trusted every day

Phone

1-855-557-5078

Customer Service Email

customerservice.yale@assaabloy.com

Technical Product Support Email

techsupport.yale@assaabloy.com

Order Entry Email

orders.yaleus@assaabloy.com

Fax

1-800-338-0965

Website

www.yalecommercial.com

Contact Us

U.S.A.

Yale Locks & Hardware

Address: 225 Episcopal Road

Berlin, CT 06037-4004

Tel: 1-800-438-1951

Fax: 1-800-338-0965

yalecommercial.com

Canada:

ASSA ABLOY Door Security Solutions Canada

Address: 160 Four Valley Drive

Vaughan, Ontario L4K 4T9

Tel: 1-800-461-3007

Fax: 1-800-461-8989

assaabloydss.ca

International:

ASSA ABLOY Americas International

Tel: 1-905-821-7775

Fax: 1-905-821-1429

assaabloyai.com



The Agion antimicrobial is not intended as a substitute for good hygiene. Coated products must still be cleaned to ensure the surfaces will be free of destructive microbes. ASSA ABLOY makes no representations or warranties, express or implied, as to the efficacy of the Agion antimicrobial. A copy of the Agion warranty is available upon request. Agion is a registered trademark of Agion Technologies, Inc., Wakefield, MA, USA.

THE YALE BRAND, with its unparalleled global reach and range of products, reassures more people in more countries than any other consumer locking solution.

THE ASSA ABLOY GROUP is the world's leading manufacturer and supplier of locking solutions, dedicated to satisfying end-user needs for security, safety and convenience.

Yale Commercial is a business associated with ASSA ABLOY Access and Egress Hardware Group, Inc., an ASSA ABLOY Group company. Copyright © 2004-2021, ASSA ABLOY Access and Egress Hardware Group, Inc. All rights reserved. Reproduction in whole or in part without the express written permission of ASSA ABLOY Access and Egress Hardware Group, Inc. is prohibited. Patent pending and/or patent www.assaabloydss.com/patents.



Auxiliary Locks

Cabinet Locks, Deadlocks, Padlocks



Table of Contents



Contents

Yale Commercial Solutions.....	3
Finishes.....	4
How to Order.....	5
D Series Cylindrical Deadbolts.....	6-10
Mortise Deadlocks.....	11-12
Padlocks.....	13-17
Auxiliary Rim Locks/Components.....	18-24
Cabinet Locks.....	25
Special Purpose Locks.....	26
Electrical Switch Cylinders.....	27
YSSL10 Auxiliary Latch.....	28

Auxiliary Locks

Yale provides a wide range of auxiliary and special purpose locks designed to fit a variety of demanding applications. Product offerings include high quality latchlocks, deadlocks, deadbolts and rim locks with both standard and alternative rim cylinders. Cabinet locks, special purpose locks and padlocks are also available, completing a collection of dependable products specifically engineered to provide strong security and key control.

Whether your requirements are for a basic or more sophisticated security system, Yale Works for YouSM.

Products

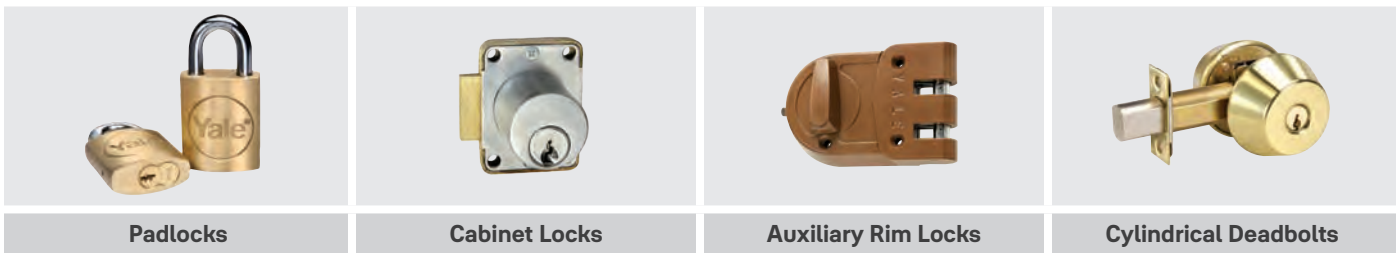

MicroShield[®]

To assist with reduction of bacteria and other microbes, Yale offers MicroShield[®], an antimicrobial coating for door hardware. MicroShield uses proven silver ion-based technology from Agion[®], a leading provider of antimicrobial solutions, to stem the spread of bacteria and other microbes. MicroShield is effective against a broad range of bacteria, mold, fungi, algae and mildew.



Yale® Commercial Solutions offers innovative and reliable products to solve the challenges of commercial, retail, hospitality, assisted living, mixed-use and multi-family properties. With over 150 years of door hardware experience, Yale's expertise extends beyond products to people - and provides the service and support you expect.

Featuring durable products to meet all your facilities' requirements, and the quality you expect from a leader in the door hardware industry, Yale Works for YouSM.

Cylindrical Locks	Mortise Locks	Exit Devices	Door Closers
			
<ul style="list-style-type: none"> • ANSI/BHMA Certification provides strength and durability • Suitable for a range of commercial applications • Available in a wide variety of functions and finishes • Ideal for offices, commercial buildings, and more 	<ul style="list-style-type: none"> • ANSI/BHMA Grade 1 Certification offers strength and reliability • Heavy-duty trim resists damage and vandalism • Well-suited to any industrial or commercial application • Ideal for offices, shopping centers, commercial spaces and more 	<ul style="list-style-type: none"> • Available in economy, commercial, architectural and traditional styles to suit any application • Rim, SquareBolt®, concealed vertical rod, surface vertical rod configurations and electrified options offered • ANSI/BHMA certifications for durability 	<ul style="list-style-type: none"> • Range of installation and arm options available • Wide variety of functions available including backcheck, closing speed, latching speed and delayed action



ANSI/BHMA Code Finish Description				
605 Bright Brass, Clear Coated	606 Satin Brass, Clear Coated	609 Satin Brass, Blackened, Satin Relieved, Clear Coated	611 Bright Bronze, Clear Coated	612 Satin Bronze, Clear Coated
613E Dark Oxidized Satin Bronze - equivalent	616 Satin Bronze, Blackened, and Satin Relieved, Clear Coated	619 Satin Nickel Plated, Clear Coated	620 Satin Nickel Plated, Blackened, Satin Relieved, Clear Coated	625 Bright Chrome Plated
626* Satin Chrome Plated	629 Bright Stainless Steel	630* Satin Stainless Steel	BSP Black Suede Powder Coat	WSP White Suede Powder Coat

613 and 722 finishes available as Special Product Requests only. Please contact Customer Service for more information.

*Finish available with MicroShield® antimicrobial coating. Add YMS suffix to order MicroShield antimicrobial coating.

MicroShield coating may vary finish color from architectural standards. MicroShield is not intended as a substitute for traditional infection control programs such as hand hygiene or use of disinfectants. Coated products must still be cleaned to ensure the surfaces will be free of destructive microbes. Yale makes no representations or warranties, express or implied, as to the efficacy of MicroShield.

The Agion antimicrobial is not intended as a substitute for good hygiene. Coated products must still be cleaned to ensure the surfaces will be free of destructive microbes. ASSA ABLOY makes no representations or warranties, express or implied, as to the efficacy of the Agion antimicrobial. A copy of the Agion warranty is available upon request. Agion is a registered trademark of Agion Technologies, Inc., Wakefield, MA, USA.

How to Order



The following is an example order string for reference when placing your order. The item you order may or may not require use of all indicated segments. Please refer to the relevant product page(s) to include all necessary information that will allow us to properly fill your order.

Qty.	Model #	Highest Keying Level	Description	Finish	Hand	Strike	Cylinder	Door Thickness	Other*
100	351	MK	Lock	612	RH	30S	2153	1-3/4"	

*Specific keying, 7-pin cylinder, spacer plate, special cylinder rings, etc.

How To Order D Series Deadbolts

Function	Hand	Cylinder	Door Thickness	Keying	Finish
D212	RH	1807	1-3/4"	KR	626

Deadbolt Model Number Description:			
D	X	X	X
Model Number	Grade	Function	Backset "1" = 2-3/8" "2" = 2-3/4"

D Series Cylindrical Deadbolts



Yale® D Series deadbolts are the ideal choice for a wide variety of commercial applications where consistent quality, ease of use and installation are required.



Technical Information

ANSI/BHMA	D100: Certified ANSI/BHMA A156.36 Grade 1. D200: Certified ANSI/BHMA A156.36 Grade 2.
Fire Listings	D series deadbolts, when used in conjunction with the primary latching device, are UL - cUL listed for use with Classified steel covered composite or hollow metal doors rated up to and including 3 hours; wood and plastic covered composite doors rated up to and including 1-1/2 hours; and wood core doors rated for 20 minutes. Note: Any retrofit or other field modification to a fire rated opening can potentially impact the fire rating of the opening, and Yale Locks & Hardware makes no representations or warranties concerning what such impact may be in any specific situation. When retrofitting any portion of an existing fire rated opening, or specifying and installing a new fire-rated opening, please consult with a code specialist or local code official (Authority Having Jurisdiction) to ensure compliance with all applicable codes and ratings.
Deadbolt	1" (25mm) throw, solid steel deadbolt with hardened, free spinning, steel pin insert.
Fronts	2-1/4" x 1" (57mm x 25mm) front and 1-1/8" (29mm) latch front filler supplied standard with each D series deadbolt.
Strikes	2-3/4" x 1-1/8" (70mm x 29mm) metal and wood door strikes with strike reinforcement supplied standard.
Handing	Functions are non-handed and easily field reversible.
Backset	2-3/4" (70mm) or 2-3/8" (60mm) backset.
Door Thickness	Standard for 1-3/8" (35mm) to 1-3/4" (44mm) thick doors.
Installation	Can be installed on doors prepared to ANSI/BHMA A156.115 specifications using a simple bored-hole installation for square or beveled doors, opening in or out.
Finishes	605, 606, 612, 613, 613E, 619, 625, 626, BSP, WSP. See page 4 for more information. Cylinders provided in 626 or 606 finish only.
Warranty	1 year mechanical

Options

- Available with visual occupancy indicator options, displaying "In Use" or "Vacant" depending on the status of the deadbolt
- Several SFIC functions feature concealed interior screws that only the control key may access. See page 7 for available functions.



Occupancy indicator options as shown when deadbolt retracted and thrown





D Series Cylindrical Deadbolts

D100 Grade 1

D111 & D112 B-D171 & B-D172*	D121 & D122**	D131 & D132	D141 & D142	D151 & D152	D161 & D162 B-D181 & B-D182*
Cylinder x Thumbturn: Deadbolt operated by key outside, thumbturn inside.	Cylinder x Cylinder: Deadbolt operated by key outside, key inside.	Cylinder x Blank Rose: Deadbolt operated by key outside. Blank rose with exposed screws inside.	Blank Plate x Thumbturn: Deadbolt operated by thumbturn inside only.	Blank Plate x Cylinder: Deadbolt operated by key inside only.	Cylinder x Classroom Thumbturn: Deadbolt operated by key outside, deadbolt retracted by thumbturn inside. Thumbturn will not project deadbolt.

*Concealed interior screws. Available SFIC only.
**SFIC version features concealed interior screws.

D200 Grade 2

D211 & D212 B-D211 & B-D212	D221 & D222**	D231 & D232	D241 & D242	D251 & D252	D261 & D262	D291 & D292
Cylinder x Thumbturn: Deadbolt operated by key outside, thumbturn inside.	Cylinder x Cylinder: Deadbolt operated by key outside, key inside.	Cylinder x Blank Rose: Deadbolt operated by key outside. Blank rose with exposed screws inside.	Blank Plate x Thumbturn: Deadbolt operated by thumbturn inside only.	Blank Plate x Cylinder: Deadbolt operated by key inside only.	Cylinder x Classroom Thumbturn: Deadbolt operated by key outside, deadbolt retracted by thumbturn inside. Thumbturn will not project deadbolt.	Occupancy Indicator x Thumbturn Deadbolt operated by thumbturn inside, emergency override key outside. Outside indicator displays "In Use" when deadbolt thrown or "Vacant" when deadbolt retracted.



Model Numbers

Model Numbers		ANSI (Grade 1 / Grade 2)	Function Description	Backset
D100	D200			
D111 or B-D171	D212	E0151 / E0152	Cylinder x Thumbturn	2-3/8"
D112 or B-D172	D212			2-3/4"
D121	D221	E0141 / E0142	Cylinder x Cylinder	2-3/8"
D122	D222			2-3/4"
D131	D231	E0161 / E0162	Cylinder x Blank Rose	2-3/8"
D132	D232			2-3/4"
D141	D241	E0191 / E0192	Blank Plate x Thumbturn	2-3/8"
D142	D242			2-3/4"
D151	D251	E0101 / E0102	Blank Plate x Cylinder	2-3/8"
D152	D252			2-3/4"
D161 or B-D181	D261	E0171 / E0172	Cylinder x Classroom Thumbturn	2-3/8"
D162 or B-D182	D262			2-3/4"
N/A	D291	N/A	Occupancy Indicator x Thumbturn	2-3/8"
N/A	D292			2-3/4"

D Series Cylinders/Keying

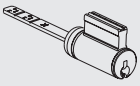

Fixed Core

Illustration	Type	Model Number	Number of Pins
	Cylinder for use with DX11, DX12, DX31, DX32, DX51, DX52, DX61, DX62. Includes breakoff tailpiece.	1807	6
	Cylinder for use with DX21, DX22. Includes optional tailpiece for 1-3/8" thick doors.	1808	6

Note: For 'X' in model number, use '1' for D100 Series and '2' for D200 Series.

Interchangeable Core

Type	Model Number	Number of Pin
Large Format Interchangeable Core	1210	6
Large Format Interchangeable Core	1220	7
Security Large Format Interchangeable Core	5210	6
Security Large Format Interchangeable Core	5220	7
Yale® KeyMark® Large Format Interchangeable Core	K800	6 or 7 (Specify)
Yale® KeyMark® Small Format Interchangeable Core	K600	6 or 7 (Specify)



K800 Shown



K600 Shown

Note: Large Format IC core available for D100 and D200 Series. Specify deadbolt model number x core model number. i.e. D112 x 1210 or D112 x 5210

Keying:

All cylinders furnished standard 6-pin, keyed random, pinned to Yale .019" specification. Each deadbolt furnished with two nickel silver keys.

Options:

Cylinders available 0-bitted, keyed alike, master keyed or construction master keyed upon request. (Yale® KeyMark® cylinders not available 0-bitted.)



Small Format Interchangeable Core

Cylinder Type	Prefix	Ordering Example
SFIC (Accepts all Small Format Interchangeable Cores) 6- or 7-pin.	B	B-D112 x 626 or B-D212 x 626

D Series Cylinders/Keying

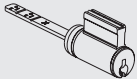

Competitor Keyway Cylinders/Cores

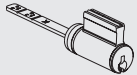
Illustration	Type	Model Number	Number of Pins
	Best® Keyway Core. Available keyed random, master keyed or uncombined. Specify keyway A, B, C, D, E, F, G, H, J, K, L or M.	A600	6 or 7 (Specify)
	Schlage® "C" Keyway Cylinder. For use with DX11, DX12, DX31, DX32, DX51, DX52, DX61, DX62. Includes breakoff tailpiece. Available 0-bitted or keyed random.	2807-C	6
	Schlage® "C" Keyway Cylinder. For use with DX21, DX22. Includes optional tailpiece for 1-3/8" thick doors. Available 0-bitted or keyed random.	2808-C	6
	Corbin Russwin "L4" Keyway Cylinder. Available keyed random.	3806 x L4	6
	Corbin "60" Keyway Cylinder. Available keyed random.	3806 x 60	6
	Russwin "D1" Keyway Cylinder. Available keyed random.	3806 x D1	6
	Sargent "LA" Keyway Cylinder. Available keyed random.	3806 x LA	6
	Schlage® "E" Keyway Cylinder. Available keyed random.	3806 x E	6

Note: 3806 cylinders are supplied with applicable tailpieces that are needed operate all D Series functions. These cylinders are not ANSI/BHMA certified.

D Series Cylindrical Deadbolts



Deadbolt Assemblies

Model No.	Backset	Throw	Front
D34	2-3/4" (70mm)	1" (25mm)	Square 2-1/4" x 1" (57mm x 25mm)
D38	2-3/8" (60mm)	1" (25mm)	Square 2-1/4" x 1" (57mm x 25mm)
D34R	2-3/4" (70mm)	1" (25mm)	Radius 2-1/4" x 1" (57mm x 25mm)
D38R	2-3/8" (60mm)	1" (25mm)	Radius 2-1/4" x 1" (57mm x 25mm)

Note: 1-1/8" (29mm) Front filler supplied standard with all square corner fronts.

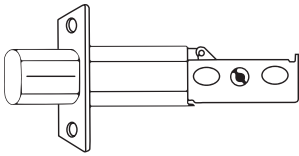

Strikes

Each D series deadbolt furnished standard with metal frame strike, wood frame strike and strike reinforcement.

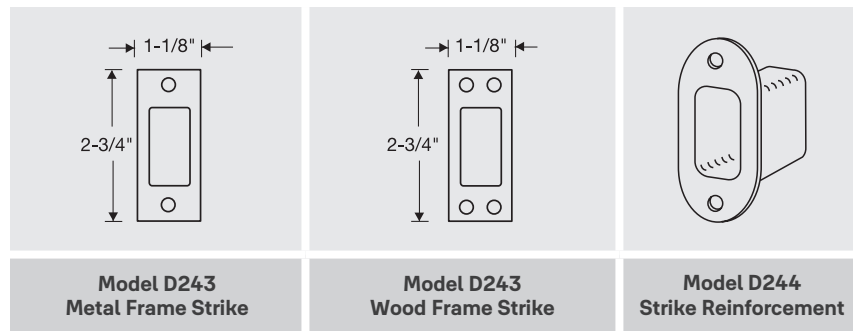

Note: Model D243 is a strike packet which includes both wood and metal frame strikes and corresponding screws.

350 Series Mortise Deadlocks



Technical Information

Description	350
Application	Mortise installation for 1-3/4" (44mm) doors, unless otherwise specified. 3" thick doors maximum for thumbturn functions.
Backset	2-3/4" (70mm) only.
Door Prep	The 350 series mortise deadlocks conform to ANSI/BHMA Specifications A156.115 which cover hardware preparations for steel doors and steel frames and A156.115-W which cover hardware preparations for wood doors with wood or steel frames.
Fire Listings	350 series deadlocks, when used in conjunction with the primary latching device, are UL - cUL listed for use on fire doors having a rating up to and including 3 hours. In addition, the 350 series are cUL listed for use on wood doors having a rating up to and including 90 minutes. Note: Any retrofit or other field modification to a fire rated opening can potentially impact the fire rating of the opening, and Yale Locks & Hardware makes no representations or warranties concerning what such impact may be in any specific situation. When retrofitting any portion of an existing fire rated opening, or specifying and installing a new fire-rated opening, please consult with a code specialist or local code official (Authority Having Jurisdiction) to ensure compliance with all applicable codes and ratings.
Handing	Functions are non-handed and easily field reversible.
Deadbolt	Laminated stacked steel with hardened pin, 1" (25mm) throw.
Front	4-5/8" x 1-1/8" (117mm x 29mm) Brass, bronze or stainless steel. Adjustable to accommodate flat or beveled-edged doors (bevel adjustment 1/8" in 2" (3mm in 51mm)).
Case	Heavy wrought steel, zinc plated and dichromated.
Finishes	605, 606, 611, 612, 613E, 618, 619, 625, 626, 629, 630, US10BL, US20D, BSP, WSP. See page 4 for more information.
Strike	3-1/2" x 1-1/8", model number 30S provided standard. ANSI/BHMA A156.115 strike 4-7/8" x 1-1/4", model number 545N optional. Optional wrought box model number 31S available to order.

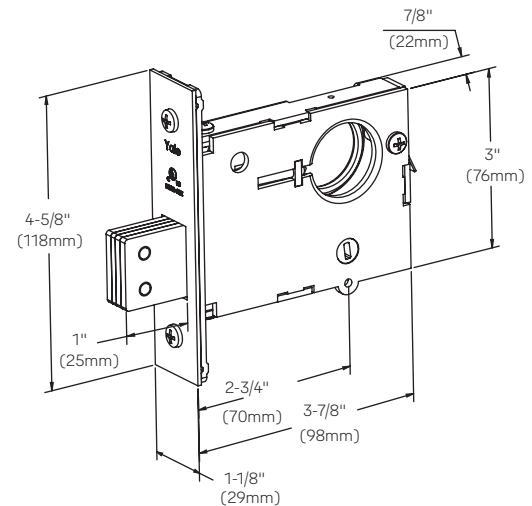

Thumbturn Assemblies

Used with all 350 series locks that have a thumbturn.

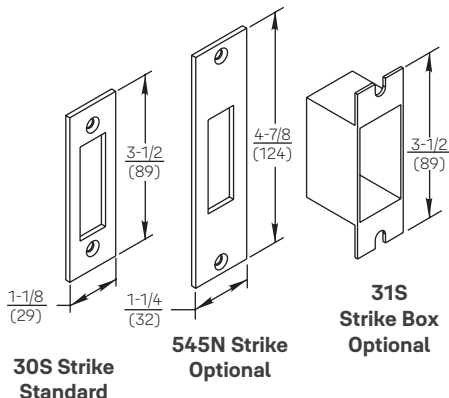
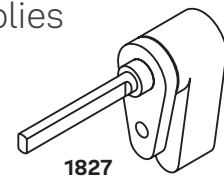



Dimensions are shown in inches (millimeters).

350 Series Mortise Deadlocks

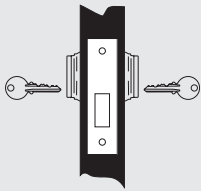
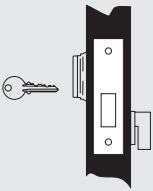
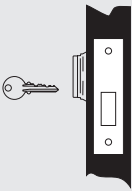

Functions

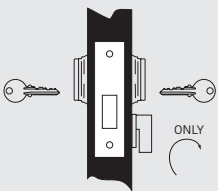
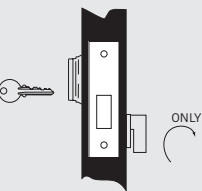
<p>351 Deadbolt operated by key outside and inside.</p>	<p>352 Deadbolt operated by key outside and thumbturn inside.</p>	<p>353 Deadbolt operated by key outside only. No inside operation.</p>
 <p>Outside Inside</p>	 <p>Outside Inside</p>	 <p>Outside Inside</p>
<p>354 Deadbolt operated by thumbturn inside only. No outside operation.</p>	<p>356 Deadbolt operated by key outside and inside. Inside thumbturn will retract deadbolt, but will not project it. Uses classroom function mortise lockbody.*</p>	<p>357 Deadbolt operated by key outside. Inside thumbturn will retract deadbolt, but will not project it. Uses classroom function mortise lockbody.*</p>
 <p>Outside Inside</p>	 <p>Outside Inside</p>	 <p>Outside Inside</p>

*351, 352, 353 and 354 use lockbody p/n 50-0352-0001-999
356 and 357 use lockbody p/n 50-0357-0001-999

Cylinders

1-1/8", 6-pin fixed core mortise cylinder, model number 2153 x 2160 cam provided standard.

Model Number	Description	Length	Cam	Collar*
2153	6-pin fixed core	1-1/8"	2160	1767.250
2153	7-pin fixed core	1-1/4"	2160	1765.375
2196	6-pin LFIC complete	1-1/2"	2160	1765.656
2197	7-pin LFIC complete	1-11/16"	2160	1765.844
5153	6-pin security fixed core	1-1/8"	2160	1765.250
5153	7-pin security fixed core	1-1/4"	2160	1765.375
5196	6-pin security LFIC complete	1-1/2"	2160	1765.656
5197	7-pin security LFIC complete	1-11/16"	2160	1765.844
K100	6-or 7-pin Yale® KeyMark® fixed core	1-1/8"	KC1	1765.312
K820	6-pin Yale KeyMark LFIC complete	1-1/2"	KC1	1765.656
K820	7-pin Yale KeyMark LFIC complete	1-11/16"	KC1	1765.844
K620	6-pin Yale KeyMark SFIC complete	1-1/4"	KC1	1765.375
K620	7-pin Yale KeyMark SFIC complete	1-3/8"	KC1	1765.563
A620	6-pin Best® keyway SFIC complete	1-1/4"	KC1	1765.375
A620	7-pin Best® keyway SFIC complete	1-3/8"	KC1	1765.563

*1-3/4" thick doors. For other door thicknesses, contact Technical Support. Collar must be specified when cylinder ordered separately.

PD400 Series Padlocks



Features

Case: Chrome Plated Steel

Shackle: High strength molybdenum alloy steel. Rust resistant with a chrome finish. Optional brass shackles available.

Shackle Diameter: 5/16" (8mm)

Shackle Locking: Two hardened steel balls at heel and toe of shackle.

Extended Shackles: Optional shackles with 2" and 3" vertical clearance are available to order.

Chains: Optional 9" chains available with clevis around shackle. To order with padlocks specify suffix:

- "S42A" = brass chain
- "S42S" = steel chain

See page 17 for chains ordered separately.

Keying: 6-pin only. Furnished standard with Yale 1801 type component cylinder; available KA, KD or master keyed only (not available 0-bitted or unassembled). Not re-keyable.

Keys: Two nickel silver change keys supplied with each padlock.

Dimensions And Details

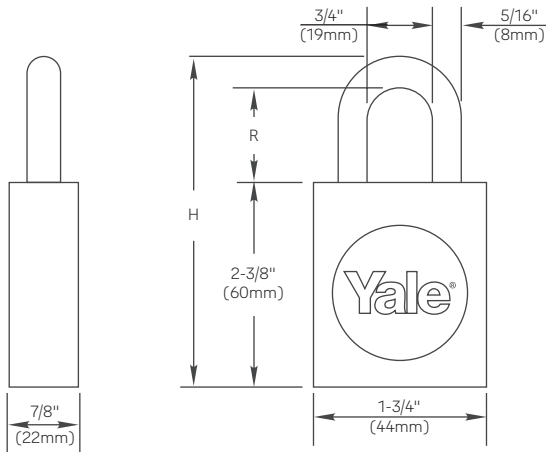

Model Numbers		Description	Vertical Clearance (R)	Overall Height (H)	Pins
Molybdenum Steel Shackle	Brass Shackle				
PD416	PD416B	Fixed Core	1-1/16" (27mm)	3-3/4" (95mm)	6
PD2416	PD2416B	Fixed Core	2" (51mm)	4-3/8" (111mm)	6
PD3416	PD3416B	Fixed Core	3" (76mm)	5-3/8" (137mm)	6

Note: All dimensions are in inches and are to the nearest 1/16" (2mm). Dimensions are nominal.

PD500 Series Padlocks



Available in fixed core, large format interchangeable core (LFIC), and small format interchangeable core (SFIC).

Features

Case: Solid Brass

Shackle: High strength molybdenum alloy steel. Rust resistant with a chrome finish. Optional brass shackles available.

Shackle Diameter: 3/8" (10mm) or 5/16" (8mm)

Shackle Locking: Two hardened steel balls at heel and toe of shackle.

Extended Shackles: Optional shackles with 2" and 3" vertical clearance are available to order.

Chains: Optional 9" chains available with clevis around shackle or riveted to case. To order with padlocks specify suffix:

- for clevis around shackle
 - "S42A" = brass chain
 - "S42S" = steel chain
- for clevis riveted to case
 - "C42A" = brass chain
 - "C42S" = steel chain

See page 17 for chains ordered separately.

Keys: Two nickel silver change keys supplied with each padlock. Control key quantity must be specified for interchangeable core.



Dimensions And Details

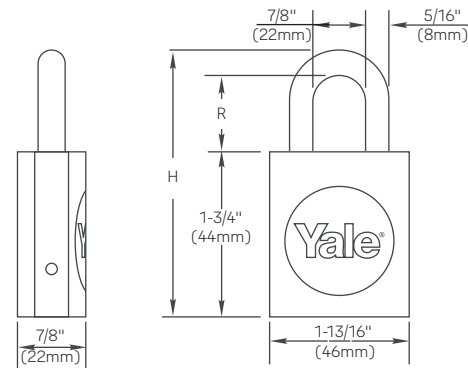

Model Numbers		Description	Case Height (C)	Vertical Clearance (R)	Diameter (S)	Overall Height (H)	Pins						
Molybdenum Steel Shackle	Brass Shackle												
PD514	PD514B	LFIC	2-5/16" (59mm)	1-1/16" (27mm)	5/16" (8mm)	3-3/4" (95mm)	6						
PD2514	PD2514B	LFIC		2" (51mm)		4-3/8" (111mm)	6						
PD3514	PD3514B	LFIC		3" (76mm)		5-3/8" (137mm)	6						
PD515	PD515B	SFIC	2-1/4" (57mm)	1-1/16" (27mm)		3/8" (10mm)	3-5/8" (91mm)	6 or 7					
PD2515	PD2515B	SFIC		2" (51mm)			4-9/16" (115mm)	6 or 7					
PD3515	PD3515B	SFIC		3" (76mm)			5-5/8" (142mm)	6 or 7					
PD516	PD516B	Fixed Core	2-5/16" (59mm)	1-1/16" (27mm)			3/8" (10mm)	3-3/4" (95mm)	6				
PD2516	PD2516B	Fixed Core		2" (51mm)				4-3/8" (111mm)	6				
PD3516	PD3516B	Fixed Core		3" (76mm)				5-3/8" (137mm)	6				
PD524	PD524B	LFIC		2-5/16" (59mm)				1-1/16" (27mm)	3/8" (10mm)	3-3/4" (95mm)	6		
PD2524	PD2524B	LFIC						2" (51mm)		4-3/8" (111mm)	6		
PD3524	PD3524B	LFIC						3" (76mm)		5-3/8" (137mm)	6		
PD534	PD534B	LFIC			2-5/16" (59mm)			1-1/16" (27mm)		3/8" (10mm)	3-3/4" (95mm)	7	
PD2534	PD2534B	LFIC						2" (51mm)			4-3/8" (111mm)	7	
PD3534	PD3534B	LFIC						3" (76mm)			5-3/8" (137mm)	7	
PD525	PD525B	SFIC				2-5/16" (59mm)		1-1/16" (27mm)			3/8" (10mm)	3-3/4" (95mm)	6 or 7
PD2525	PD2525B	SFIC						2" (51mm)				4-3/8" (111mm)	6 or 7
PD3525	PD3525B	SFIC						3" (76mm)				5-3/8" (137mm)	6 or 7
PD526	PD526B	Fixed Core	2-5/16" (59mm)				1-1/16" (27mm)	3/8" (10mm)				3-3/4" (95mm)	6
PD2526	PD2526B	Fixed Core					2" (51mm)					4-3/8" (111mm)	6
PD3526	PD3526B	Fixed Core					3" (76mm)					5-3/8" (137mm)	6

Note: All dimensions are in inches and are to the nearest 1/16" (2mm). Dimensions are nominal.

PD500 Series Padlocks



Keying: Padlocks available 0-bitted, uncombined, keyed alike keyed different or master keyed. Note: Yale KeyMark cylinders and cores are not available 0-bitted.



LFIC – Padlocks furnished standard less core. Available for Yale 6- or 7-pin large format interchangeable core. Specify core and keying required.

Cores:

Model Number	Description
1210	6-pin Conventional
1220	7-pin Conventional
5210	6-pin Security
5220	7-pin Security
K800	6- or 7-pin Yale® KeyMark® (Specify number of pins required)

SFIC – Padlocks furnished standard less core. Available for 6- or 7-pin small format interchangeable core. Specify core and keying if required.

Cores:

Model Number	Description
K600	6- or 7-pin Yale® KeyMark® (Specify number of pins required)
A600	6- or 7-Pin Best® Keyway (Specify keyway and number of pins required)



Fixed Core – Available in 6-pin only. Furnished standard with Yale 1801 type component cylinder for easy re-keying in field. Security and Yale® KeyMark® cylinders available to order. Less cylinder also available, specify "x LC". Padlocks provided less cylinder are furnished with cylinder sleeve and adaptor.

Cylinders:

Model Number	Description
1801	Standard
5801	Security
K400	Yale® KeyMark®
2801	Schlage® C Keyway (0-bitted or keyed random only)



Cylinder and Sleeve	
Unassembled	Assembled

PD600 Series Padlocks



Features

Case: Solid brass

Shackle: High strength molybdenum alloy steel. Rust resistant with a chrome finish.

Shackle Diameter: 5/16" (8mm)

Shackle Locking: Two hardened steel balls at heel and toe of shackle.

Extended Shackles: Optional shackles with 2" and 3" vertical clearance are available to order.

Chains: Optional 9" chains available with clevis around shackle or riveted to case. To order with padlocks specify suffix:

- for clevis around shackle
 - "S42A" = brass chain
 - "S42S" = steel chain
- for clevis riveted to case
 - "C42A" = brass chain
 - "C42S" = steel chain

See page 17 for chains ordered separately.

Keying: 6-pin only. Furnished standard with Yale 1801 type component cylinder; available KA, KD or master keyed (not available 0-bitted or unassembled). Not re-keyable.

Keys: Two nickel silver change keys supplied with each padlock.

Note: The PD616 padlocks are key retaining. This means that the key cannot be removed from the padlock while the shackle is in the "unlocked" position. The key can only be removed if the shackle is in the "locked" position.



Dimensions And Details

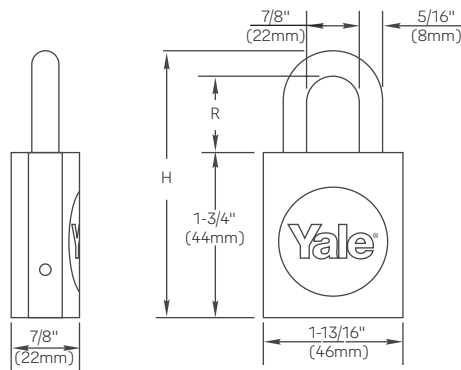

Model Numbers	Description	Vertical Clearance (R)	Overall Height (H)	Pins
Molybdenum Steel Shackle				
PD616	Fixed Core	1-3/16" (30mm)	3-1/4" (82mm)	6
PD2616	Fixed Core	1-1/2" (38mm)	3-9/16" (90mm)	6

Note: All dimensions are in inches and are to the nearest 1/16" (2mm). Dimensions are nominal.

Padlock Chains



525 shown.

Model No.	Material	Minimum Length	Shackle Diameter	Gauge Size
42A	Brass	9" (229mm)	9/32"-5/16" (7mm-8mm)	15
42S	Steel	9" (229mm)	9/32"-5/16" (7mm-8mm)	15

Chains are used with PD400, PD500 and PD600 series padlocks. All chains are double-link type.

42A and 42S chains riveted to case.
Specify suffix "C42A" or "C42S".



42A and 42S chains with clevis.
Specify suffix "S42A" or "S42S".

Security Latchlock 80



Operation

Outside: Furnished standard with 5-pin rim cylinder 1109E.

Inside: Bolt can be deadlocked or held back by slide button, rendering the lock inoperable by key or knob.

Model Numbers	
80	Boxed
V80	Visual Pack

Dimensions And Details

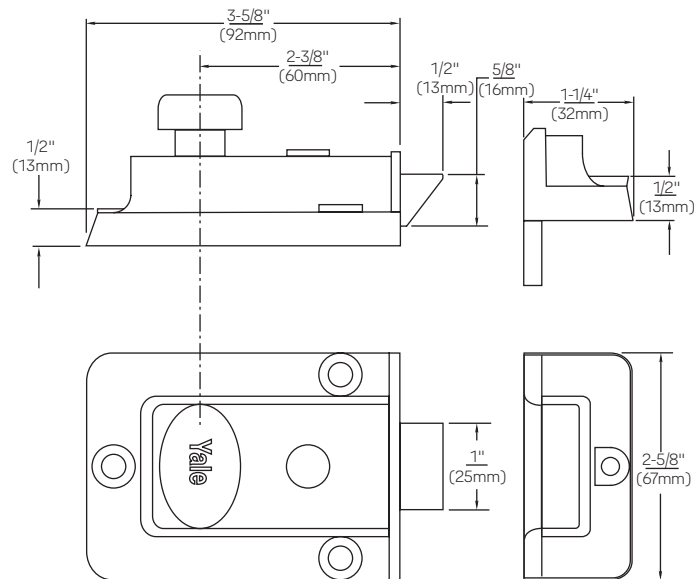

Technical Information

Description	80
Backset	2-3/8" (60mm)
Material	Zinc Alloy
Springbolt Length	1/2" (13mm)
Reversible Latchbolt	Yes, order #8RB Strike
Cylinder	1109E - Brass 5-pin with anti-pick mushroom drivers
Case Finishes	Enameled Brasslux only
Cylinder Finish	Brass
2 Keys	RB8
Door Thickness	1-3/8" to 2-1/4" (35mm-57mm)

Dimensions are shown in inches (millimeters).

Security Latchlock 88



Operation

Outside: Furnished standard with 5-pin rim cylinder 1109E.

Inside: Bolt can be deadlocked or held back by slide button, rendering the lock inoperable by key or handle.

Model Numbers	
88	Boxed

Dimensions And Details

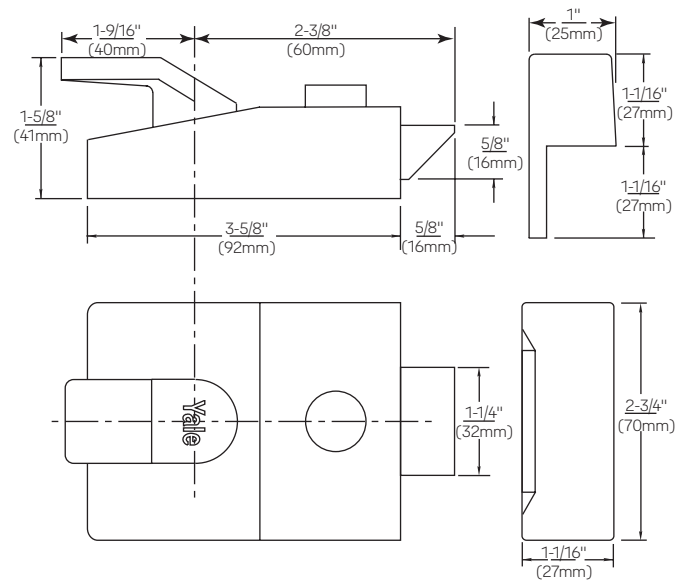

Technical Information

Description	88
Backset	2-3/8" (60mm)
Material	Zinc Alloy
Springbolt Length	5/8" (16mm)
Reversible Latchbolt	Yes, order #8RB Strike
Cylinder	1109E - Brass 5-pin with anti-pick mushroom drivers
Case Finishes	Dark Metallic Grey only
Cylinder Finish	Brass
2 Keys	RB8
Door Thickness	1-3/8" to 2-1/4" (35mm-57mm)

Dimensions are shown in inches (millimeters).

Heavy-Duty Latchbolt 112



Operation

Outside: Furnished standard with 5-pin rim cylinder 1109E.

Inside: 180° turn of the thumbturn throws or retracts deadbolt. Also available with flat strike, model no. 112F (for outswinging doors).

Dimensions And Details

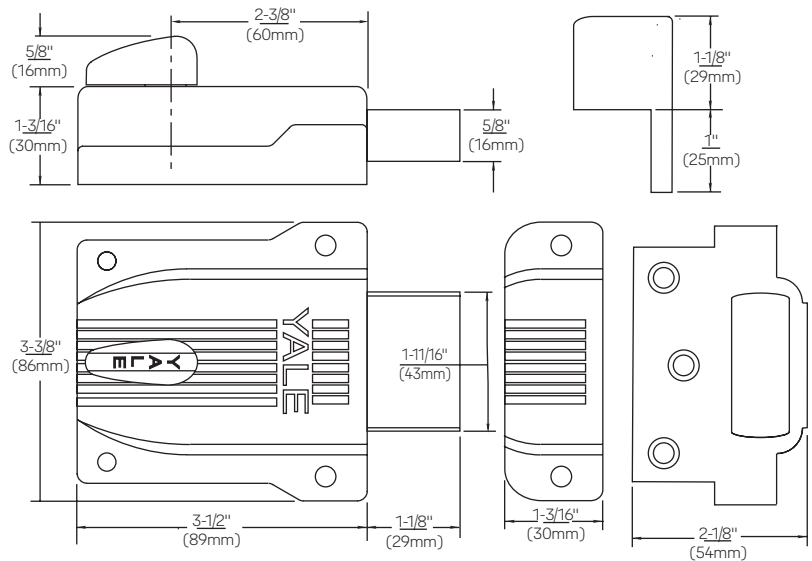

Model Numbers	
112	Boxed
112F	Flat Strike, Boxed

Technical Information

Description	112
Backset	2-3/8" (60mm)
Material	Zinc Alloy
Springbolt Length	1-1/8" (29mm)
Cylinder	1109E Brass 5-pin with anti-pick mushroom drivers
Case Finishes	Sprayed Brass only
Cylinder Finish	Brass
2 Keys	RB8
Door Thickness	1-3/8" to 2-1/4" (35mm-57mm)

Dimensions are shown in inches (millimeters).



Heavy-Duty Deadbolt 112-1/4



Operation

Outside: Furnished standard with 5-pin rim cylinder 1109E.

Inside: Turning the key throws or retracts the deadbolt. Also available with flat strike, model no. 112-1/4F (for outswinging doors).

Model Numbers	
112-1/4	Boxed
112-1/4F	Flat Strike, Boxed

Dimensions And Details

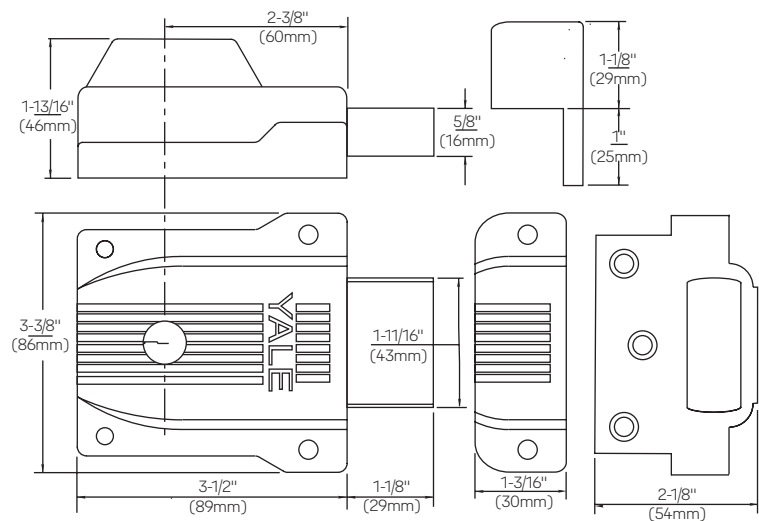

Technical Information

Description	112-1/4
Backset	2-3/8" (60mm)
Material	Zinc alloy
Deadbolt Length	1-1/8" (29mm)
Cylinder (Outside)	1109E Brass 5-pin with anti-pick mushroom drivers
Cylinder (Inside)	Fixed 3-pin Brass cylinder. No alternatives.
Case Finishes	Sprayed Brass only
Cylinder Finish	Brass
2 Keys	RB8
Door Thickness	1-3/8" to 2-1/4" (35mm-57mm)

Dimensions are shown in inches (millimeters).

Jimmy-Proof Deadlock 197



Operation

Outside: Furnished standard with 5-pin rim cylinder 1109E.

Inside: 90° turn of the thumbturn locks or unlocks deadbolt. Also available with flat strike, model no. 197F (for outswinging doors).

Model Numbers	
197	Boxed
V197	Visual Pack
197F	Flat Strike, Boxed

Dimensions And Details

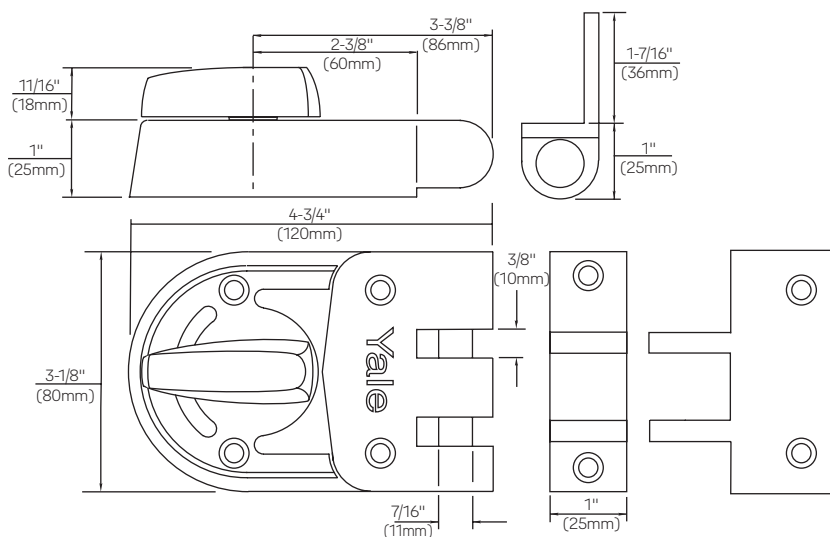

Technical Information

Description	197
Backset	2-3/8" (60mm)
Material	Zinc Alloy
Deadbolt Length	N/A
Reversible Latchbolt	N/A
Cylinder	1109E - Brass 5-pin with anti-pick mushroom drivers
Case Finishes	Sprayed Brass only
Cylinder Finish	Brass
2 Keys	RB8
Door Thickness	1-3/8" to 2-1/4" (35mm-57mm)

Dimensions are shown in inches (millimeters).

Jimmy-Proof Deadlock 197-1/4



Operation

Outside: Furnished standard with 5-pin rim cylinder 1109E.

Inside: Key locks or unlocks deadbolt. Also available with flat strike, model no. 197-1/4F (for outswinging doors).

Model Numbers	
197-1/4	Boxed
V197-1/4	Visual Pack
197-1/4F	Flat Strike, Boxed

Dimensions And Details

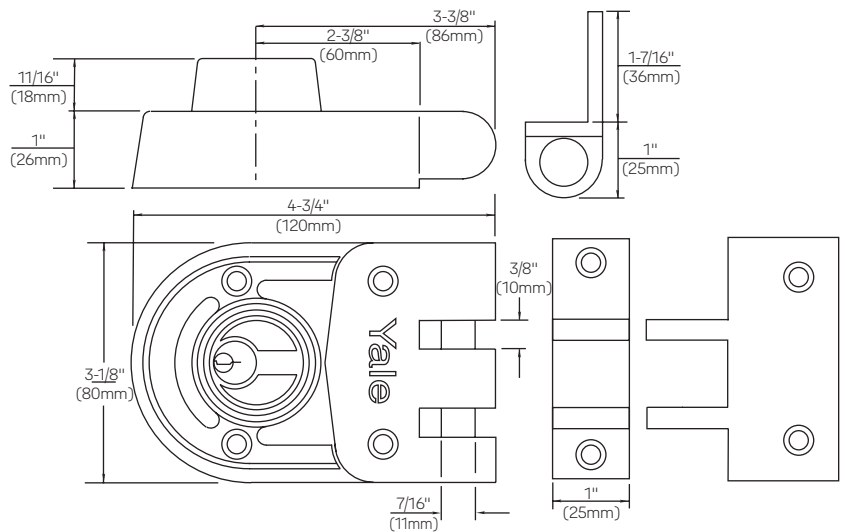

Technical Information

Description	197-1/4
Backset	2-3/8" (60mm)
Material	Zinc Alloy
Deadbolt Length	N/A
Reversible Latchbolt	N/A
Cylinder (Outside)	1109E Brass 5-pin with anti-pick mushroom drivers
Cylinder (Inside)	Fixed 3-pin Brass cylinder. No alternatives.
Case Finishes	Sprayed Bronze only
Cylinder Finish	Brass
2 Keys	RB8
Door Thickness	1-3/8" to 2-1/4" (35mm-57mm)

Dimensions are shown in inches (millimeters).

Auxiliary Rim Lock Components



Cylinders

Yale® auxiliary rim locks 80, 88, 112, 112-1/4, 197, and 197-1/4 are shipped standard with an 1109E brass, 5-pin, E1R (PARA) section rim cylinder. The 1109E is not available as a replacement cylinder.

Note: 1109E depths and spacings are not compatible with other cylinders available from Yale Locks & Hardware.

For alternative rim cylinders, refer to Yale® KeyMark® and/or Yale Cylinder and Keys catalog sections.

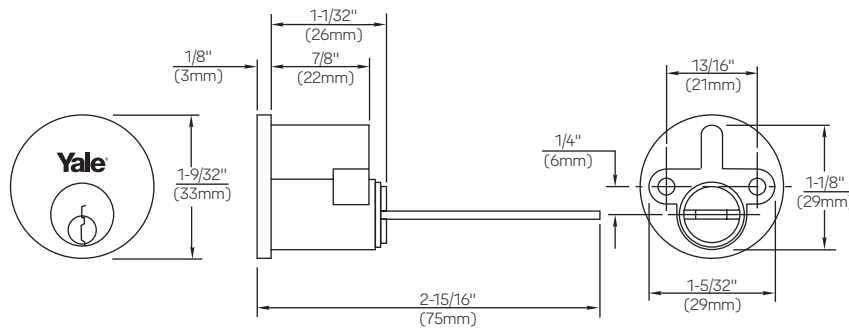

Strikes

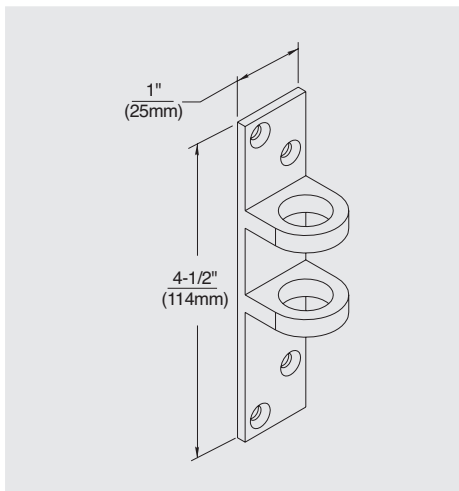

No. 197FS Flat Strike

Used with 197F and 197-1/4F for outswing doors.

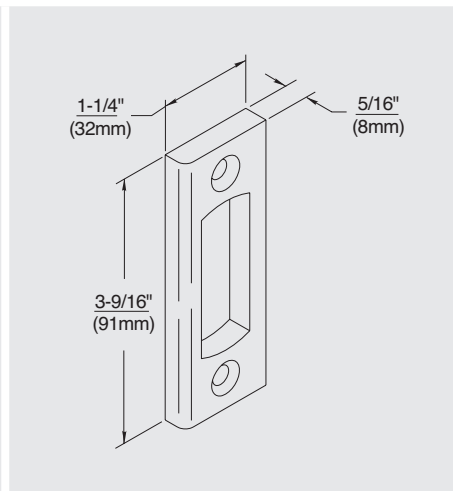

No. 112FS Flat Strike

Used with 112F and 112-1/4F for outswing doors.

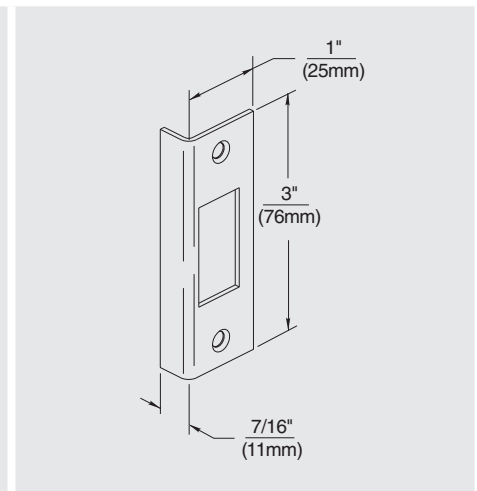

No. 8RB Rim Strike

Used with 80 and 88 for outswing doors.

Dimensions are shown in inches (millimeters).

Cabinet Locks



511s



Application: Pin tumbler lock for 3/4" (19mm), 1" (25mm), 1-1/8" (29mm) or 1-3/8" (35mm) wood or metal wardrobe doors.
Operation: Key retracts latchbolt.
Material: All brass.

Finishes: Nose and scalp 605 standard; 606, 625 and 626 to order.
Keying: 4-, 5-, or 6-pin tumblers, two keys. Can be Master Keyed and Grand Master Keyed.
Handed: Specify RH or LH. Right hand shown.

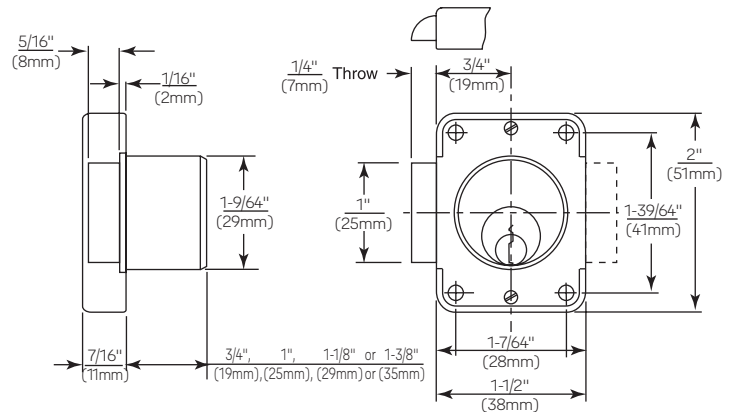

Note: 3/4" available 4-pin only. 1" available 5-pin only.

C970



Operation: Key rotates plug 360°. Key removable in vertical position only. Cam stop pin packed with each cylinder for restricted cam rotation when desired.

Finishes: Available in all finishes as per page 4.
Material: Brass cylinder and cam.
Keys: 5- or 6-pin.

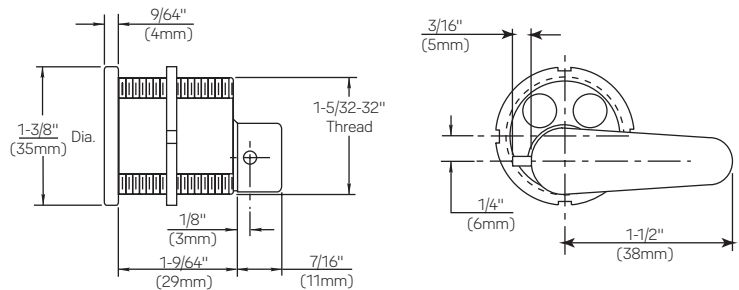

Accessories

511S Angle Strike

May be specified with surface type Spring Bolt Lock 511S.

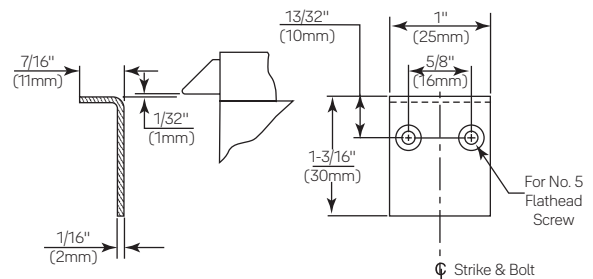

Dimensions are shown in inches (millimeters).

Auxiliary Locks

Special Purpose Lock C1810



C1810 Letter Box Lock

Finishes: 606 and 626.

Keying: Standard 5- or 6-pin, all cylinders drilled for 6-pin. Can be keyed into 7-pin system, first six pins active, or with special long cylinder with 7 active pins.

Available: KD standard. KA or MK (for special purposes) by order. Cannot be Construction Master Keyed. Two keys.

Cam: Part No. 30-0501-2001-999

Screws: Part No. 81-0021-1102-999

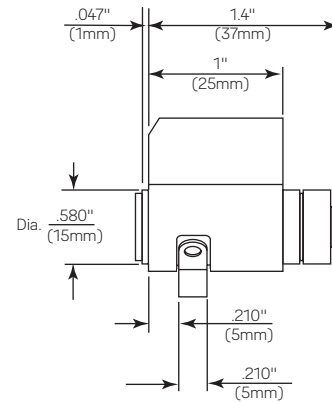
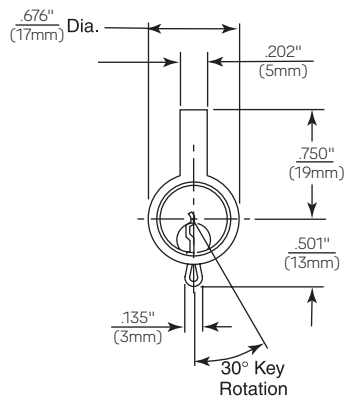

C900 Series Electrical Switch Cylinders



Operation: Key rotates plug 360°. Key removable in one, two, or three positions.
Material: Brass and bronze. Brass attaching nuts.

Finishes: 606, 626.
Keying: 5-pin tumblers; two No. 11 keys.
Cylinder Nut:
 Part No. 60-7000-2421-000

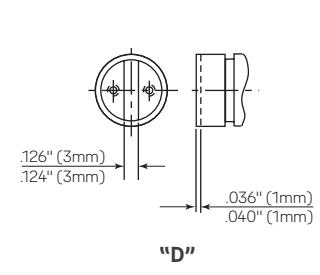
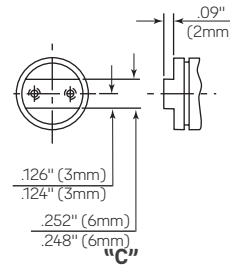
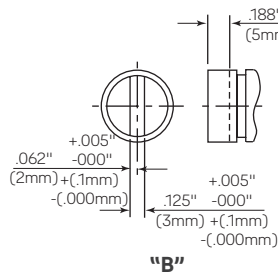
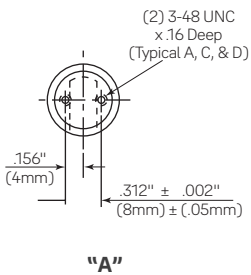
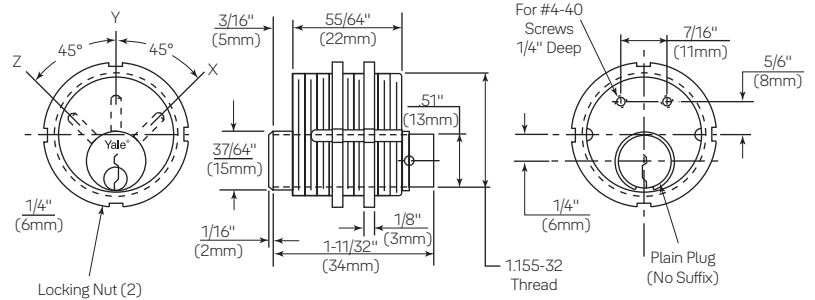

One-Position Key Removable

Model No.	Key Rem. Pos.	Plug Config.	Old Model No.
C910	Y	Plain	C950
C910A	Y	A	C950A
C910B	Y	B	C950B
C910C	Y	C	C954A
C910D	Y	D	C950A
C911	Z	Plain	C951
C911A	Z	A	C951B
C911B	Z	B	C951D
C911C	Z	C	--
C911D	Z	D	--

Two-Position Key Removable

Model No.	Key Rem. Pos.	Plug Config.	Old Model No.
C920	X-Y	Plain	C960
C920A	X-Y	A	C960A
C920B	X-Y	B	C960B
C920C	X-Y	C	C952A
C920D	X-Y	D	--
C921	Y-Z	Plain	--
C921A	Y-Z	A	C951A
C921B	Y-Z	B	C951C
C921C	Y-Z	C	C953A
C921D	Y-Z	D	--
C922	X-Z	Plain	C972
C922A	X-Z	A	--
C922B	X-Z	B	--
C922C	X-Z	C	--
C922D	X-Z	D	--

Three-Position Key Removable

Model No.	Key Rem. Pos.	Plug Config.	Old Model No.
C930	X-Y-Z	Plain	C971
C930A	X-Y-Z	A	C971A
C930B	X-Y-Z	B	C971B
C930C	X-Y-Z	C	--
C930D	X-Y-Z	D	--

When Ordering

Specify keyway and bitting No. (C910 and C911 models can be master keyed). Specify finish. (Standard finishes 606 and 626.) If mounting nuts are not required, specify "w/o nuts."

Dimensions are shown in inches (millimeters).

YSSL10 Auxiliary Latch



Security SideLite offered through CECO and CURRIES

The YSSL10 is a spring loaded latchbolt which is operated by a thumbturn on the inside of the door. The outside does not offer operation. This latch is only recommended for areas with alternate exits.

The YSSL10, when combined with ASSA ABLOY Group brands CECO and CURRIES' Security SideLite doors, offers an effective solution for privacy or lockdown situations.

Applications

- Security SideLite doors offered by CECO and CURRIES
- Dutch doors
- Communicating doors
- Shallow closets

Technical Information

Description	YSSL10
ADA	ADA compliant thumbturn.
Fire Listings	UL - cUL fire rated up to 3 hours.
Backset	2-3/4" (70mm) only.
Latchbolt	1/2" (13mm) brass throw.
Door Thickness	1-3/4" (44mm) only.
Front	2-1/4" x 1" (57mm x 25mm) flat front.
Handing	Functions are non-handed and easily field reversible.
Finishes	605, 606, 612, 625, 626, BSP
Strike	1-1/4" (32mm) curved lip standard (model number 371).
Warranty	1 year mechanical

Strike

Model No. 371 T-Strike

1-1/4" curved lip supplied standard. 1", 1-1/2", 1-3/4", and 2" curved lip lengths available by special order. Wrought strike box supplied.

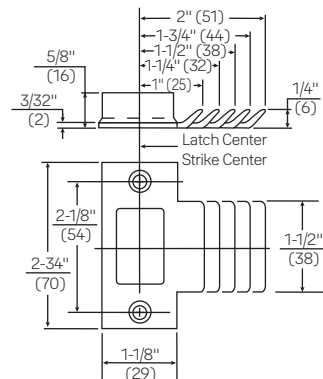





Trusted every day

Customer Service Phone:

1-800-438-1951

Customer Service Fax:

1-800-338-0965

24/7 Support Phone:

1-855-213-5841

24/7 Support Email:

Support@YaleLock.com

Website:

US.YaleHome.com

Email for orders:

orders.yaleres@assaabloy.com

Contact Us

U.S.A.

Yale Locks & Hardware

Address: 225 Episcopal Road

Berlin, CT 06037-4004

Tel: 1-800-438-1951

Fax: 1-800-338-0965

yalelocks.com

Canada:

ASSA ABLOY Door Security Solutions Canada

Address: 160 Four Valley Drive

Vaughan, Ontario L4K 4T9

Tel: 1-800-461-3007

Fax: 1-800-461-8989

assaabloydss.ca

International:

ASSA ABLOY Americas International

Tel: 1-905-821-7775

Fax: 1-905-821-1429

assaabloyai.com

THE YALE BRAND, with its unparalleled global reach and range of products, reassures more people in more countries than any other consumer locking solution.

THE ASSA ABLOY GROUP is the world's leading manufacturer and supplier of locking solutions, dedicated to satisfying end-user needs for security, safety and convenience.

Yale Commercial is a business associated with ASSA ABLOY Access and Egress Hardware Group, Inc., an ASSA ABLOY Group company. Copyright © 2002-2020, ASSA ABLOY Access and Egress Hardware Group, Inc. All rights reserved. Reproduction in whole or in part without the express written permission of ASSA ABLOY Access and Egress Hardware Group, Inc. is prohibited. Patent pending and/or patent www.assaabloydss.com/patents.



7000 Series Architectural Exit Devices



Table of Contents



Contents

Introduction.....	3	Concealed Vertical Rod Devices	
Benefits & Features.....	4	7120(F).....	18
Finishes.....	5	7160(F).....	19
How to Order.....	6	7220.....	20
Rim Devices		7220M(F).....	21
7100(F).....	7	Trim Designs.....	22-30
7200.....	8	Electrified Options.....	31-39
7200M(F).....	9	Electrical System Guide.....	40-41
SquareBolt® Devices		Functions.....	42-43
7150(F).....	10	Applications.....	44-48
7250.....	11	Cylinders.....	49-50
7250M(F).....	12	Collars & Tailpieces.....	53
Mortise Devices		Strikes.....	54-55
7130(F).....	13	Accessories/Options.....	56-59
Surface Vertical Rod Devices		Mullions.....	59-60
7110(F).....	14	Dimensions.....	61-62
7170(F).....	15	Sample Specifications.....	63
7210.....	16		
7210M(F).....	17		

7000 Series Exit Devices

Yale® 7000 Series Exit Devices deliver an unparalleled combination of durability, innovation and aesthetics. With ANSI/BHMA Grade 1 certification and a full range of mechanical and electromechanical functions and accessories, the 7000 Series can be easily integrated into existing security or fire alarm systems to ensure the safety of every opening. The simple, clean lines and variety of available finishes suit the modern decor of any commercial building.





When the beauty of your facility matters almost as much as life safety, Yale Works for YouSM.

Introduction

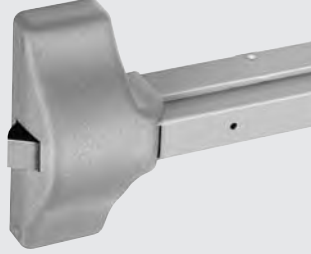

Yale® Commercial Solutions offers innovative and reliable products to solve the challenges of commercial, retail, hospitality, assisted living, mixed-use, and multi-family properties. With over 150 years of door hardware experience, Yale's expertise extends beyond products to people - and provides the service and support you expect.

Featuring durable products to meet all your facilities' requirements - and the quality you expect from a leader in the hardware industry. Yale works for youSM.

Yale Exit Devices			
6000 Series	2100 Series	1800 Series	1500 Series
			
<ul style="list-style-type: none"> • Ideal for facilities that require modern form and full functionality to meet their life safety needs • Wide & Narrow Stile Applications • Rim, Squarebolt, CVR, SVR & Mortise • Mechanical & Electro-Mechanical Functions • Aluminum rail assembly with Architectural Metals • Solid Cast Flush End Cap • ANSI/BHMA Certified Grade 1 • UL Rated for Panic & Fire • 10 Year Warranty 	<ul style="list-style-type: none"> • Ideal for commercial applications and budget conscious end users • Narrow & Wide Stile Applications • Rim, Squarebolt, CVR & SVR • Mechanical Functions • ANSI/BHMA Grade 1 Certified • UL Rated for Panic & Fire • Architectural & Painted Finishes • 3 Year Warranty 	<ul style="list-style-type: none"> • Ideal for back of the house where function and code compliance are the requirement • Wide Stile Applications • Rim & SVR • Mechanical Functions • ANSI/BHMA Certified Grade 1 • UL Rated for Panic & Fire • Powder-coat Painted Finishes • 1 Year Warranty 	<ul style="list-style-type: none"> • Ideal for renovation projects where historical preservation is the desired look • Wide Stile Applications • Rim, CVR, SVR & Mortise • ANSI/BHMA Certified Grade 1 • UL Rated for Panic & Fire • Architectural & Painted Finishes • 1 Year Warranty

Benefits & Features



Benefits

- **Innovative:** Featuring patented security options including SquareBolt® latchbolt and delayed egress function
- **Durable:** Heavy-duty steel components are ANSI/BHMA Grade 1 certified for the ultimate in strength and security
- **Flexibility:** Various options available to customize this exit device to suit any opening
- **Clean, modern look:** Sleek design with a variety of attractive finish options to suit any decor

Features

- High quality steel chassis and heavy-duty components
- Full range of mechanical and electromechanical options to suit any life safety application and pair with existing security systems
- ANSI/BHMA Grade 1 certified
- UL/cUL listed for panic and fire doors
- Windstorm certified (refer to local codes)  Hurricane
- Five year mechanical warranty, one year trim warranty, two year warranty on electrical options and components

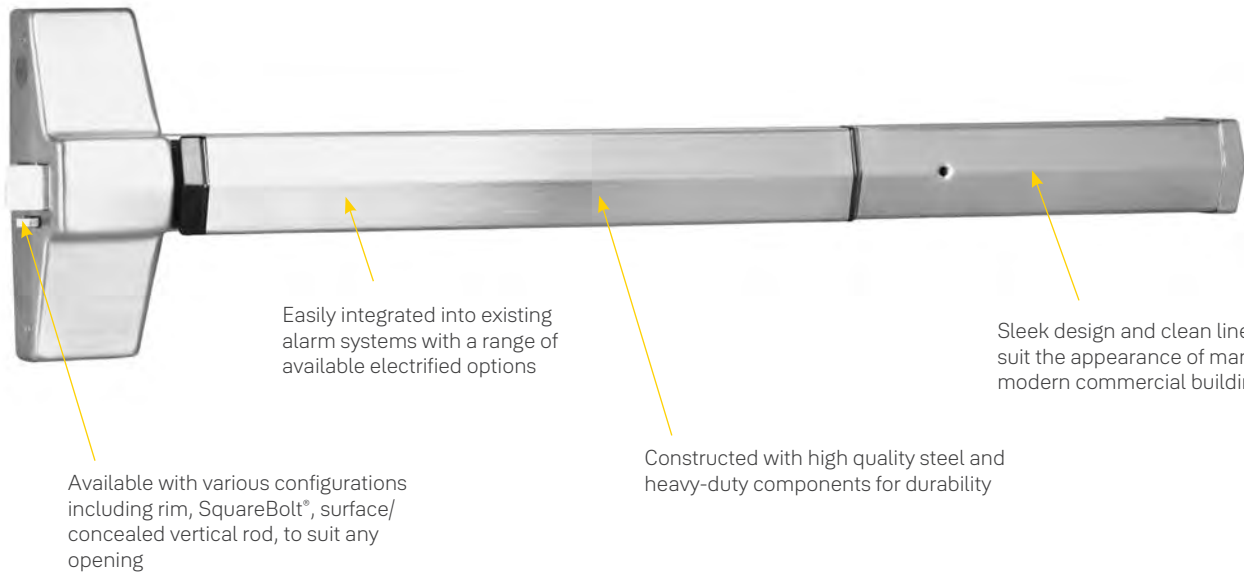

Now Available with Motorized Electric Latch Retraction!

The Motorized Electric Latch Retraction (MELR) feature provides remote-controlled latch retraction that delivers quiet, smooth operation for convenient, hassle-free egress. Easily installed in new applications and available as retrofit rail kit assemblies for field updates, the MELR features maintenance-free design with few moving parts using 86% less power consumption during retraction than solenoid devices. Plus, MELR is powered by a standard power supply, simplifying installation and increasing system design flexibility. See page 32 for more details.



Finishes



ANSI/BHMA Code Finish Description					
605 Bright Brass, Clear Coated	606 Satin Brass, Clear Coated	609 Satin Brass, Blackened, Satin Relieved, Clear Coated	611 Bright Bronze, Clear Coated	612 Satin Bronze, Clear Coated	613E Dark Oxidized Satin Bronze - equivalent
616 Satin Bronze, Blackened, and Satin Relieved, Clear Coated	619* Satin Nickel Plated, Clear Coated	620 Satin Nickel Plated, Blackened, Satin Relieved, Clear Coated	625 Bright Chrome Plated (540F trim only)	626* Satin Chrome Plated (Trim only)	629 Bright Stainless Steel
630* Satin Stainless Steel	693 Black Painted	BSP Black Suede Powder Coat	WSP White Suede Powder Coat		

613, 626 and 722 finishes available as Special Product Requests only. Please contact Customer Service for more information.

*Finish available with MicroShield® antimicrobial coating, additional finishes by special application. Consult factory for availability.

MicroShield coating may vary finish color from architectural standards. MicroShield is not intended as a substitute for traditional infection control programs such as hand hygiene or use of disinfectants. Coated products must still be cleaned to ensure the surfaces will be free of destructive microbes. Yale makes no representations or warranties, express or implied, as to the efficacy of MicroShield.

Finishes For Touchbar Covers Only

ANSI/BHMA Code	Finish Description
BN ³	Semi-gloss black fused polymer
LUM	Lumi-lite Photoluminescence
SS	Stainless Steel

Lumi-Lite

Lumi-lite uses photoluminescence technology to provide visibility of exit doors in low-light, no light or smoky conditions. Lumi-lite can be ordered with your 7000 Series Exit Device or easily retrofitted to existing devices. See Lumi-lite Touchpad Cover on page 57 for more information.



How To Order



From this outline select the Model Number for the Yale® 7000 Exit Device Series you require.

7	X	X	X	Mechanical/Electrical	Size	Design	Trim	Finish	Other Info.
	Second Digit: "1" - Standard device, 4-1/2" (114mm) or wider door stile. "2" - Narrow stile door or narrow escutcheon trim (500F, 510F Series)	Third Digit: "0" - Rim Device, Pullman Latch "1" - SVR Device up to 8' "2" - CVR Device, Metal Doors up to 8' "3" - Mortise Device "5" - SquareBolt®, Rim Security "6" - CVR Device over 8', wood door or LBR "7" - SVR Device over 8' or LBR	Fourth Digit: "0" - Standard "5" - Cylinder Dogging (Not with suffix "F")	Mechanical Feature  "F" - Fire Exit Device "M" - Narrow escutcheon trim in 4-1/2" (114mm) or wider door stile "LBR" - Less Bottom Rod ² "L5" - Mortise Device, Entry by Key with/without Rigid Lever ¹ "L8" - Mortise Device, Entry by Lever "T5" - Mortise Device with Thumbpiece Trim "T8" - Mortise Device, Active Thumbpiece Trim "2" - Double Cylinder Device ³ "WS" - Windstorm Certified Products ^{5,6,7} Electrical Feature "-A" - Alarm Kit "-B" - Bar Monitor or Signaling "-D" - Delayed Egress "-G" - Electric Dogging "-O" - Outside Trim Monitor or Signaling "-MELR" - Motorized Electric Latch Retraction "-S" - Latchbolt Status Monitor or Signaling "-Safe" - Mortise Device Trim Control (Lever only) "-Secure" - Mortise Device Trim Control (Lever only)		Trim Design (Lever only)	Trim Model Number	See page 4	Other Information: Door Hand - RHR or LHR Door Thickness - Over 1-3/4" (45mm) Fastener Options - TORX® Security Screws SNB (wood, composite, or unreinforced metal doors) Specialty Cylinders & Components Lumi-lite: LUM

Ordering Examples

Exit Device Only

7150D-36 x 619 x RHR x SNB

Exit Device with Trim and Cylinder*

7170F90-9-48 x AU626F x 605 x LHR x 1109 GA 0-bit

Trim Only

M0656F x 630 x RHR x LC

Double Cylinder Exit Device with Trim

7150F-2-36 x AU626F x 630

*Yale® exit devices and trims are processed separately. To aid in order processing, the device, trim and cylinder should be detailed as separate line items. These items can be ordered on one line item as shown, but they will be entered to the factory and acknowledged separately.

It is recommended that exit devices and trim for the same opening be ordered together. Standard product is for 1-3/4" (44mm) reinforced metal doors. Accessories detached from the device and trim should be specified separately. Materials by others are required to be fit for the purpose as detailed in this catalog and the product installation literature.

Notes:

1. Required for electrical feature, Suffix "-SAFE" or "-SECURE".
2. LBR available on 7160(F90) and 7170(F90) devices only.
3. For double cylinder devices, suffix "-2" after fourth digit.
4. If "-24" device is to be used with a DOW greater than 24", the device will ship without UL label. The 12" touchpad will not cover 50% of the device touchbar length.
5. "WS" applies only to 7150(F), 7250M(F) and 7170(F) devices.
6. Maximum opening size 8'0" x 8'0".
7. Contact Ceco, Curries® or Fleming for detailed frame/door requirements and limitations.

7100(F) Rim



The 7100(F) is a rim exit device to be used with single doors or pairs of doors constructed of metal, wood or composite materials. Designed for application in high-use areas, the 7100(F) comes in a variety of finishes and can be combined with a variety of trims to match any desired style.



Features

- Designed for wide stile doors
- 3/4" throw deadlocking stainless steel pullman latchbolt
- Electroplated ferrous components provide corrosion resistance
- Available in double cylinder function (handing must be specified)

Applications

- Non-handed for easy installation
- Single swing doors
- Pairs of doors with removable mullions
- Metal, wood or composite door materials

Specifications

Door Opening Width	-24 for 24" (60cm) doors -36 for 30" - 36" (76cm - 91cm) doors -48 for 36" - 48" (91cm - 122cm) doors Optional sizes can be special ordered. Consult Technical Product Support.
Door Thickness	1-3/4" (44mm) standard. Optional door thicknesses available to 4-1/2"; specify door thickness when ordering.
Minimum Stile Width	4-1/2" (114mm)
Projection	3-1/4" (83mm) active, 2-3/4" (70mm) dogged
Latchbolt	3/4" (19mm) deadlocking stainless steel pullman-type
Strike	757F, 793 optional (double door application, panic only)
Fasteners	Machine screws and wood door fasteners standard for panic hardware. Sex nuts and bolts supplied standard for fire exit hardware.
Trims	620F series escutcheon trim, 630F series pull/thumbpiece trim, 680F series offset pull trim, 540F series rose trim, 121NL cylinder only. See pages 22-24.
ANSI/BHMA	Certified A156.3 Type 1, Grade 1
UL/cUL	FVSR/FVSR - Panic hardware; GXHX/GXHX7 - Fire exit hardware (F) (4' x 8' single, 8' x 8' pairs, 3 hr.)
Dogging	Hex key dogging supplied standard on panic devices
Options	Cylinder dogging, shim kit #723, sex nuts and bolts, MicroShield®, Lumi-lite
Warranty	5-year limited



7200 Rim



The 7200 is a narrow stile rim exit device compatible with the aesthetics and functional requirements of contemporary doors. The 7200 comes in varied finishes and can be combined with a variety of trims to match any desired style.



Features

- Designed for narrow stile doors
- 3/4" throw deadlocking stainless steel pullman latch
- Non-handed for easy installation

Applications

- Single swing narrow stile doors
- Pairs of narrow stile doors with removable mullions
- Metal and aluminum doors
- For panic-rated doors only

Specifications

Door Opening Width	-24 for 24" (60cm) doors -36 for 30" - 36" (76cm - 91cm) doors -48 for 36" - 48" (91cm - 122cm) doors Optional sizes can be special ordered. Consult Technical Product Support.
Door Thickness	1-3/4" (44mm) standard. 2" (51mm) and 2-1/4" (57mm); specify when ordering.
Minimum Stile Width	2" (51mm)
Projection	3-1/4" (83mm) active, 2-3/4" (70mm) dogged
Latchbolt	3/4" (19mm) deadlocking stainless steel pullman type.
Strike	Standard: 759. Optional: 793 (double door applications, panic only)
Fasteners	Machine screws standard for panic hardware
Trims	500F series escutcheon trim, 510F series pull/thumbpiece trim, 480F series offset pull trim. See pages 25-26.
ANSI/BHMA Certified	A156.3, Type 4, Grade 1
UL/cUL	FVSR/FVSR7 - Panic hardware
Dogging	Hex key dogging supplied standard
Options	Cylinder dogging, shim kit #723NS, sex nuts and bolts, MicroShield®, Lumi-lite
Warranty	5-year limited



7200M(F) Rim



The 7200M(F) rim exit device provides the appearance of a narrow stile rim exit device for use on wide stile or flush doors. Using the 7200M(F) with narrow stile trim provides design continuity and pleasing aesthetics when matching exit devices for inside doors to outside narrow stile doors.



Features

- Narrow stile appearance designed for wide stile or flush doors
- 3/4" throw deadlocking stainless steel pullman latchbolt
- Non-handed for easy installation
- Fully adjustable surface mounted 3/8" diameter roller strike complete with positive locking plate and shims

Applications

- Single swing doors
- Pairs of doors with removable mullions
- Metal, wood or composite door materials

Specifications

Door Opening Width	-24 for 24" (60cm) doors -36 for 30" - 36" (76cm - 91cm) doors -48 for 36" - 48" (91cm - 122cm) doors Optional sizes can be special ordered. Consult Technical Product Support.
Door Thickness	1-3/4" (44mm) standard. 2" (51mm) and 2-1/4" (57mm); specify when ordering.
Minimum Stile Width	4-1/2" (114mm)
Projection	3-1/4" (83mm) active, 2-3/4" (70mm) dogged
Latchbolt	3/4" (19mm) deadlocking stainless steel pullman type
Strike	757F, 793 optional (double door application, panic only)
Fasteners	Machine screws and wood door fasteners standard for panic hardware. Sex nuts and bolts supplied standard for fire exit hardware.
Trims	500F series escutcheon trim, 510F series pull/thumbpiece trim, 480F series offset pull trim. See pages 25-26.
ANSI/BHMA	A156.3, Type 4, Grade 1
UL/cUL	FVSR/FVSR7 - Panic hardware; GXHX/GXHX7 - Fire exit hardware (F) (4' x 8' single, 8' x 8' pairs, 3 hr.)
Dogging	Hex key dogging supplied standard on panic devices
Options	Cylinder dogging, shim kit #723NS, sex nuts and bolts, MicroShield®, Lumi-lite
Warranty	5-year limited



7150(F) Rim SquareBolt®



Just as easy to open as traditional latchbolts, the SquareBolt® exit device's unique construction offers innovative protection. Its patented SquareBolt (Pat. no. 5,605,362) design presents an improved physical barrier over standard rim latchbolts. The SquareBolt exit device locks into place and stays there. Credit cards, crowbars, door rattling and shaking are resisted, significantly reducing the threat of unauthorized entry.



Features

- Patented SquareBolt security deadbolt (Pat. no. 5,605,362) designed for maximum holding power
- Non-handed for easy installation
- Can be retrofitted onto existing 7100 series templated doors
- Fully adjustable surface-mounted 3/8" diameter roller strike complete with positive locking plate and shims
- Available in double cylinder function (handing must be specified)
- Available certified hurricane resistant (refer to local codes). Specify 7150(F)WS  Hurricane

Applications

- Single swing doors
- Pairs of doors with removable mullions
- Metal, wood or composite door materials

Specifications

Door Opening Width	-24 for 24" (60cm) doors -36 for 30" - 36" (76cm - 91cm) doors -48 for 36" - 48" (91cm - 122cm) doors Optional sizes can be special ordered. Consult Technical Product Support.
Door Thickness	1-3/4" (44mm) standard. Optional door thicknesses available to 4-1/2"; specify door thickness when ordering.
Minimum Stile Width	4-1/2" (114mm)
Projection	3-1/4" (83mm) active, 2-3/4" (70mm) dogged
Deadbolt	Patented 1" (25mm) slide projection bolt with full 3/4" (19mm) projection
Strike	757F, 793 optional (double door application, panic only)
Fasteners	Machine screws and wood door fasteners standard for panic hardware. Sex nuts and bolts supplied standard for fire exit hardware.
Trims	620F series escutcheon trim, 630F series pull/thumbpiece trim, 680F series offset pull trim, 540F series rose trim, 121NL cylinder only. See pages 22-24.
ANSI/BHMA	A156.3, Type 4 or 28, Grade 1
UL/cUL	FVSR/FVSR7 - Panic hardware; GXHX/GXHX7 - Fire exit hardware (F) (4' x 8' single, 8' x 8' pairs, 3 hr.); ZHEM - Latching hardware; ZHLA - Windstorm rated assemblies
Dogging	Hex key dogging supplied standard on panic devices
Options	Cylinder dogging, shim kit #723, sex nuts and bolts, MicroShield®, Lumi-lite
Warranty	5-year limited



7250 Rim SquareBolt®



The unique construction of the SquareBolt exit device offers innovative protection. The patented square latchbolt design provides an improved physical barrier over standard pullman-type rim latchbolts. It locks into place and stays there. Credit cards, crowbars, door rattling and shaking are resisted, significantly reducing the threat of unauthorized entry, especially in applications that include removable mullions. The 7250 SquareBolt is designed for narrow stile doors.



Features

- Patented SquareBolt security deadbolt (Pat. no. 5,605,362) designed for maximum holding power
- Non-handed for easy installation
- Maintains the look of the Yale® 7200 series architectural exit devices, allowing for continuity in both design and finish
- Fully adjustable surface mounted 3/8" diameter roller strike complete with positive locking plate and shims
- Used with narrow stile trim

Applications

- Single swing narrow stile doors
- Pairs of narrow stile doors with removable mullions
- Metal and aluminum doors
- For panic-rated doors only

Specifications

Door Opening Width	-24 for 24" (60cm) doors -36 for 30" - 36" (76cm - 91cm) doors -48 for 36" - 48" (91cm - 122cm) doors Optional sizes can be special ordered. Consult Technical Product Support.
Door Thickness	1-3/4" (44mm) standard. 2" and 2-1/4" (51mm and 57mm); specify when ordering.
Minimum Stile Width	2" (51mm)
Projection	3-1/4" (83mm) active, 2-3/4" (70mm) dogged
Deadbolt	Patented 1" (25mm) slide projection bolt with full 3/4" (19mm) projection
Strike	Standard: 759. Optional: 793 (double door applications, panic only)
Fasteners	Machine screws standard for panic hardware
Trims	500F series escutcheon trim, 510F series pull/thumbpiece trim, 480F series offset pull trim. See pages 25-26.
ANSI/BHMA	Certified A156.3, Type 4 or 28, Grade 1
UL/cUL	FVSR/FVSR7 - Panic hardware
Dogging	Hex key dogging supplied standard
Options	Cylinder dogging, shim kit #723NS, sex nuts and bolts, MicroShield®, Lumi-lite
Warranty	5-year limited



7250M(F) Rim SquareBolt®



The unique construction of the 7250M(F) SquareBolt exit device offers innovative protection while maintaining the appearance of a narrow stile exit device. The patented square latchbolt design provides an improved physical barrier over standard pullman-type latchbolts. The 7250M(F) SquareBolt is designed for wide stile or flush doors and provides design continuity of the 7200 series exit devices.

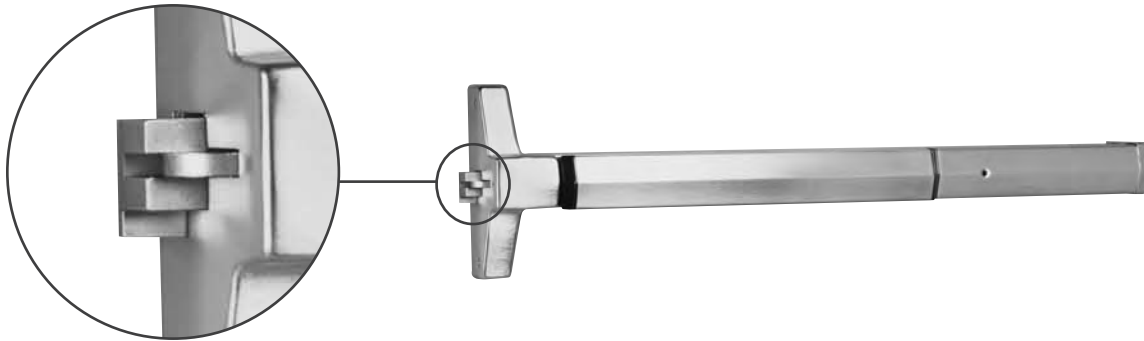

Features

- Patented SquareBolt security deadbolt (Pat. no. 5,605,362) designed for maximum holding power
- Non-handed for easy installation
- Maintains the look of the Yale® 7200 series architectural exit devices, allowing for continuum in both design and finish
- Fully adjustable surface mounted 3/8" diameter roller strike complete with positive locking plate and shims
- Used with narrow stile trim
- Available certified hurricane resistant (refer to local codes). Specify 7250M(F)WS



Applications

- Single swing doors
- Pairs of doors with removable mullions
- Metal, wood or composite door materials

Specifications

Door Opening Width	-24 for 24" (60cm) doors -36 for 30" - 36" (76cm - 91cm) doors -48 for 36" - 48" (91cm - 122cm) doors Optional sizes can be special ordered. Consult Technical Product Support.
Door Thickness	1-3/4" (44mm) standard. 2" (51mm) and 2-1/4" (57mm); specify when ordering.
Minimum Stile Width	4-1/2" (114mm)
Projection	3-1/4" (83mm) active, 2-3/4" (70mm) dogged
Deadbolt	Patented 1" (25mm) slide projection bolt with full 3/4" (19mm) projection
Strike	757F, 793 optional (double door application, panic only)
Fasteners	Machine screws and wood door fasteners standard for panic hardware. Sex nuts and bolts supplied standard for fire exit hardware.
Trims	500F series escutcheon trim, 510F series pull/thumbpiece trim, 480F series offset pull trim. See pages 25-26.
ANSI/BHMA	Certified A156.3, Type 4 or 28, Grade 1
UL/cUL	FVSR/FVSR7 - Panic hardware; GXHX/GXHX7 - Fire exit hardware (F) (4' x 8' single, 8' x 8' pairs, 3 hr.); ZHEM - Latching hardware; ZHLA - Windstorm rated assemblies
Dogging	Hex key dogging supplied standard on panic devices
Options	Cylinder dogging, shim kit #723NS, sex nuts and bolts, MicroShield®, Lumi-lite
Warranty	5-year limited



7130(F) Mortise



The 7130(F) is an exit device integrated with the Yale® 8700 Series Mortise Lock for use on single doors or active leaf of a pair of doors where life safety and extra security are required. The 8700 Series Mortise Lock used is modified for use with exit devices only.



Applications

- Single swing doors
- Pairs of doors with vertical rod devices or automatic flush bolts
- Metal, wood or compatible door materials

Order as follows, according to function.	
7130-K5(F)	(01) Exit only.
	(02) Entry by pull when dogged.
	(03) Key retracts latchbolt.
	Electrical control for trim, w/wo key override.
7130-L5(F)	(02) Entry by rigid lever when dogged.
	(03) Key retracts latchbolt.
	Electrical control for trim, w/wo key override.
7130-T5(F)	(02) Entry by pull when dogged. (03) Key retracts latchbolt.
7130-L8(F)	(08) Entry by lever lock/unlocked by key or lever only (passage).
7130-L8(F)-2	(08) Entry by lever lock/unlocked by key either side or lever only (passage).
7130-T8(F)	(05) Entry by thumbpiece lock/unlocked by key or thumbpiece only (passage).

Specifications

Door Opening Width	-24 for 24" (60cm) doors -36 for 30" - 36" (76cm - 91cm) doors -48 for 36" - 48" (91cm - 122cm) doors Optional sizes can be special ordered. Consult Technical Product Support.
Door Thickness	1-3/4" (44mm) standard. 2" and 2-1/4" (51mm and 57mm) optional; specify when ordering.
Minimum Stile Width	4-1/2" (114mm)
Projection	3-1/4" (83mm) active, 2-3/4" (70mm) dogged
Latchbolt	Two piece mechanical 3/4" (19mm) deadlocking stainless steel with anti-friction insert and auxiliary deadlocking latch
Strike	Curved lip, non-handed 798. Optional 712 for door pairs with astragals. Optional 718 open back strike.
Fasteners	Machine screws and wood door fasteners standard for panic hardware. Sex nuts and bolts supplied standard for fire exit hardware.
Trims	620F/650F series escutcheon trim, 630F/660F/670F series pull/thumbpiece trim, 684F offset pull trim. See pages 22-24.
ANSI/BHMA	Certified A156.3 Type 3, Grade 1
UL/cUL	FVSR/FVSR7 - Panic hardware; GXHX/GXHX7 - Fire exit hardware (F) (4' x 8' single, 8' x 8' pairs, 3 hr.) (4' x 9' single, 8' x 9' pairs, 1-1/2 hr.)
Dogging	Hex key dogging supplied standard on panic devices
Options	Cylinder dogging, shim kit #723, sex nuts and bolts, MicroShield®, Lumi-lite
Warranty	5-year limited



7110(F) Surface Vertical Rod



The 7110(F) is a surface vertical rod exit device to be used on wide stile or flush doors up to 8' (fire) and 10' (panic) where two-point latching is desired.

Features

- Designed for wide stile and flush doors
- Handed. Specify hand (field reversible)
- Bottom deadbolt for secure latching
- Fully adjustable roller strike

Applications

- Pairs of doors
- Double egress
- Metal, wood or composite door materials

Specifications



Door Opening Width	-24 for 24" (60cm) doors -36 for 30" - 36" (76cm - 91cm) doors -48 for 36" - 48" (91cm - 122cm) doors Optional sizes can be special ordered. Consult Technical Product Support.
Door Opening Height	Standard door height 7' (213cm), with the device centerline at 39-15/16" (101cm) from floor. Optional heights up to 8' (fire) and 10' (panic) available by using rod extensions. For fire rated openings over 8', see 7170F SVR.
Door Thickness	1-3/4" (44mm) standard. Optional door thicknesses available to 4-1/2"; specify door thickness when ordering.
Minimum Stile Width	4-1/2" (114mm)
Projection	3-1/4" (83mm) active, 2-3/4" (70mm) dogged
Latchbolt	Top: 3/4" (19mm) throw, pullman-type with automatic deadlatching Bottom: 5/8" (16mm) throw deadbolt, held retracted during door swing
Vertical Rods	1/2" O.D. tubular brass, bronze or stainless steel with rod guides
Strike	Top: Roller type 791. Bottom: Flush mounted 790. 794 floor strike optional (threshold openings).
Fasteners	Machine screws and wood door fasteners standard for panic hardware. Sex nuts and bolts supplied standard for fire exit hardware.
Trims	620F series escutcheon trim, 630F series pull/thumbpiece trim, 680F series offset pull trim, 540F series rose trim. See pages 22-24.
ANSI/BHMA	Certified A156.3 Type 2, Grade 1
UL/cUL	FVSR/FVSR7 - Panic hardware; GXHX/GXHX7 - Fire exit hardware (F) (8' x 8' pairs, 3 hr.)
Dogging	Hex key dogging supplied standard on panic devices
Options	Cylinder dogging, shim kit #724, sex nuts and bolts, rod extensions, bottom pullman latch (panic only) MicroShield®, Lumi-lite
Warranty	5-year limited



7170(F) Surface Vertical Rod



The 7170(F) is a surface vertical rod exit device to be used on wide stile and flush doors up to 10' where one- or two-point latching is desired. A Less Bottom Rod (LBR) option is available.

Features

- Designed for wide stile and flush doors
- Handed. Specify hand (field reversible)
- Interlocking top strike and latch mounting plate
- Available less bottom rod (LBR option)
- Available certified hurricane resistant (refer to local codes ~ not approved for LBR). Specify 7170(F)WS  Hurricane

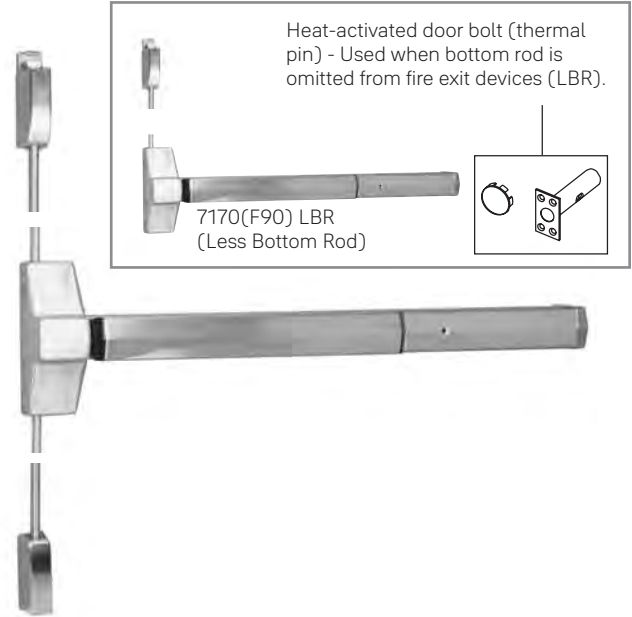

Applications

- Pairs of doors
- Double egress
- Metal or wood doors

Specifications

Door Opening Width	-24 for 24" (60cm) doors -36 for 30" - 36" (76cm - 91cm) doors -48 for 36" - 48" (91cm - 122cm) doors Optional sizes can be special ordered. Consult Technical Product Support.
Door Opening Height	Standard door height 7' (213cm), with the device centerline at 39-15/16" (101cm) from floor. Optional heights specify suffix -8, -9, -10.
Door Thickness	1-3/4" (44mm) standard. Optional door thicknesses available to 4-1/2"; specify door thickness when ordering.
Minimum Stile Width	4-1/2" (114mm)
Projection	3-1/4" (83mm) active, 2-3/4" (70mm) dogged
Latchbolt	Top: 3/4" (19mm) throw, pullman-type with automatic deadlatching Bottom: 5/8" (16mm) throw deadbolt, held retracted during door swing
Vertical Rods	1/2" O.D. tubular brass, bronze or stainless steel with rod guides
Strike	Top: 726. Bottom: Flush-mounted 790. 794 floor strike optional (threshold openings).
Fasteners	Machine screws and wood door fasteners standard for panic hardware. Sex nuts and bolts supplied standard for fire exit hardware.
Trims	620F series escutcheon trim, 630F series pull/thumbpiece trim, 680F series offset pull trim, 540F series rose trim. See pages 22-24.
ANSI/BHMA	Certified A156.3 Type 2, Grade 1
UL/cUL	FVSR/FVSR7 - Panic hardware; GXHX/GXHX7 - Fire exit hardware (F) (8' x 10' pairs, 1-1/2 hr.) (8' x 8' pairs, 3 hr.); ZHEM - Latching hardware; ZHLA - Windstorm rated assemblies
Dogging	Hex key dogging supplied standard on panic devices
Options	Cylinder dogging, shim kit #724, sex nuts and bolts, bottom pullman latch (panic only), less bottom rod (LBR), -8, -9, -10 opening height, rod extensions, MicroShield®, Lumi-lite.
Warranty	5-year limited



7210 Surface Vertical Rod



The 7210 is a narrow stile surface vertical rod exit device to be used on narrow stile, aluminum and metal doors where two-point latching is desired.

Features

- Designed for narrow stile doors
- Handed. Specify hand (field reversible)
- Bottom deadbolt for secure latching
- Fully adjustable roller strike

Applications

- Pairs of narrow stile doors
- Metal and aluminum doors
- For panic-rated doors only



Specifications

Door Opening Width	-24 for 24" (60cm) doors -36 for 30" - 36" (76cm - 91cm) doors -48 for 36" - 48" (91cm - 122cm) doors Optional sizes can be special ordered. Consult Technical Product Support.
Door Opening Height	Standard door height 7' (213mm), with the device centerline at 39-15/16" (101cm) from floor. Optional heights specify suffix -8, -9, -10.
Door Thickness	1-3/4" (44mm) standard. 2" (51mm) and 2-1/4" (57mm); specify when ordering.
Minimum Stile Width	2" (51mm).
Projection	3-1/4" (83mm) active, 2-3/4" (70mm) dogged
Latchbolt	Top: 3/4" (19mm) stainless steel throw, pullman-type with automatic deadlatching. Bottom: 5/8" (16mm) throw deadbolt, held retracted during door swing.
Vertical Rods	1/2" (13mm) O.D. tubular brass, bronze or stainless steel with rod guides.
Strike	Top: Roller type 791. Bottom: Flush mounted 790. 794 floor strike optional (threshold openings).
Fasteners	Machine screws standard for panic hardware.
Trims	500F series escutcheon trim, 510F series pull/thumbpiece trim, 480F series offset pull trim. See pages 25-26.
ANSI/BHMA	Certified A156.3 Type 5, Grade 1
UL/cUL	FVSR/FVSR7 - Panic hardware
Dogging	Hex key dogging supplied standard
Options	Cylinder dogging, shim kit #724, sex nuts and bolts, -8, -9, -10 opening height, rod extensions, bottom pullman latch, MicroShield®, Lumi-lite
Warranty	5-year limited





7210M(F) Surface Vertical Rod

The 7210M(F) is a narrow appearance surface vertical rod exit device to be used on wide stile and flush metal or wood doors where two-point latching is desired.

Features

- Narrow stile appearance designed for wide stile doors
- Handed. Specify hand (field reversible)
- Fully adjustable roller strike

Applications

- Pairs of doors
- Double egress
- Metal, wood or composite door materials



Specifications

Door Opening Width	-24 for 24" (60cm) doors -36 for 30" - 36" (76cm - 91cm) doors -48 for 36" - 48" (91cm - 122cm) doors Optional sizes can be special ordered. Consult Technical Product Support.
Door Opening Height	Standard door height 7' (213mm), with the device centerline at 39-15/16" (101cm) from floor. Optional heights specify suffix -8 (fire and panic), -9, -10 (panic only).
Door Thickness	1-3/4" (44mm) standard. 2" (51mm) and 2-1/4" (57mm); specify when ordering.
Minimum Stile Width	4-1/2" (114mm)
Projection	3-1/4" (83mm) active, 2-3/4" (70mm) dogged
Latchbolt	Top: 3/4" (19mm) stainless steel throw, pullman-type with automatic deadlatching. Bottom: 5/8" (16mm) throw deadbolt, held retracted during door swing.
Vertical Rods	1/2" (13mm) O.D. tubular brass, bronze or stainless steel with rod guides.
Strike	Top: Roller type 791. Bottom: Flush mounted 790. 794 floor strike optional (threshold openings).
Fasteners	Machine screws and wood door fasteners standard for panic hardware. Sex nuts and bolts supplied standard for fire exit hardware.
Trims	500F series escutcheon trim, 510F series pull/thumbpiece trim, 480F series offset pull trim. See pages 25-26.
ANSI/BHMA	Certified A156.3, Type 5, Grade 1
UL/cUL	FVSR/FVSR7 - Panic hardware; GXHX/GXHX7 - Fire exit hardware (F) (8' x 8' pairs, 3 hr.)
Dogging	Hex key dogging supplied standard on panic devices
Options	Cylinder dogging, shim kit #724NS, sex nuts and bolts, bottom pullman latch (panic only), -8, -9, -10 opening height, rod extensions, MicroShield®, Lumi-lite
Warranty	5-year limited



7120(F) Concealed Vertical Rod



The 7120(F) is a concealed vertical rod exit device to be used on metal doors only up to 8' (fire) and 10' (panic) where two-point latching is desired.

Features

- Designed for wide stile and flush doors
- Handed. Specify hand (field reversible)
- Bottom deadbolt for secure latching
- Fully adjustable roller strike

Applications

- Pairs of doors
- Double egress
- Metal doors only



Specifications

Door Opening Width	-24 for 24" (60cm) doors -36 for 30" - 36" (76cm - 91cm) doors -48 for 36" - 48" (91cm - 122cm) doors Optional sizes can be special ordered. Consult Technical Product Support.
Door Opening Height	Standard door height adjustable to 8' (244cm), with the device centerline at 39-15/16" (101cm) from floor. Optional heights up to 10' (panic) available by using rod extensions. For fire rated openings over 8', see 7160F CVR.
Door Thickness	1-3/4" (44mm) standard. 2" and 2-1/4" (51mm and 57mm) optional; specify when ordering.
Minimum Stile Width	4-1/2" (114mm)
Projection	3-1/4" (83mm) active, 2-3/4" (70mm) dogged
Latchbolt	Top: 3/4" (19mm) throw, pullman-type with automatic deadlatching Bottom: 5/8" (16mm) throw deadbolt, held retracted during door swing
Vertical Rods	1/2" (13mm) O.D. telescoping tubular rods
Strike	Top: Roller type 791 (panic and fire). Bottom: Flush mounted 790 (panic and fire). 794 floor strike optional (threshold openings).
Fasteners	Machine screws standard for panic hardware. Sex nuts and bolts supplied standard for fire exit hardware.
Trims	620F series escutcheon trim, 630F series pull/thumbpiece trim, 680F series offset pull trim, 540F series rose trim. See pages 22-24.
ANSI/BHMA	Certified A156.3 Type 8, Grade 1
UL/cUL	FVSR/FVSR7 - Panic hardware; GXHX/GXHX7 - Fire exit hardware (F) (8' x 8' pairs, 3 hr.)
Dogging	Hex key dogging supplied standard on panic devices
Options	Cylinder dogging, shim kit #723, sex nuts and bolts, rod extensions, bottom pullman latch (panic only) MicroShield®, Lumi-lite
Warranty	5-year limited

Note: Not available with Less Bottom Rod option



7160(F) Concealed Vertical Rod



The 7160(F) is a concealed vertical rod exit device to be used on wood and metal doors up to 10' where one- or two-point latching is desired. A Less Bottom Rod (LBR) option is available.

Features

- Designed for wide stile and flush doors
- Handed. Specify hand (field reversible)
- Mortised top strike
- Available less bottom rod (LBR option)

Applications

- Pairs of doors
- Double egress
- Metal, wood, or composite door materials

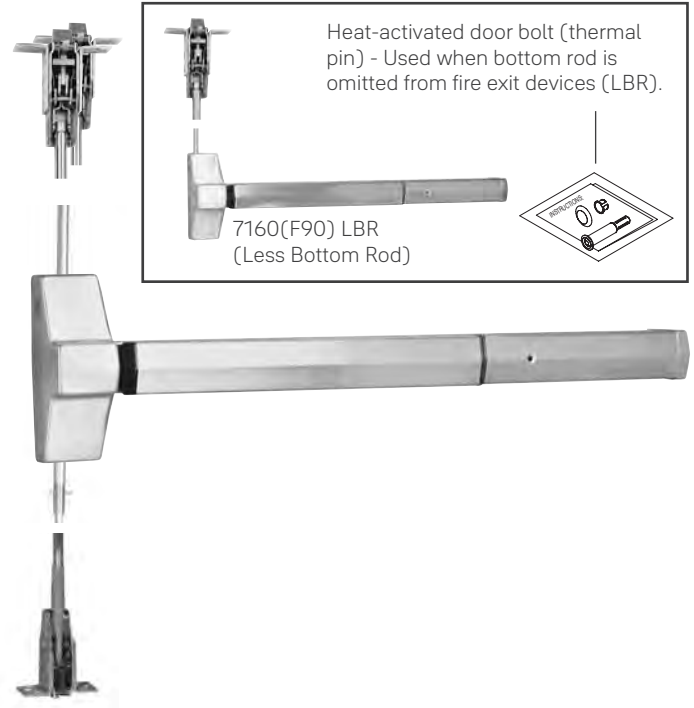

Specifications

Door Opening Width	-24 for 24" (60cm) doors -36 for 30" - 36" (76cm - 91cm) doors -48 for 36" - 48" (91cm - 122cm) doors Optional sizes can be special ordered. Consult Technical Product Support.
Door Opening Height	Standard door height adjustable to 8' (244cm), with the device centerline at 39-15/16" (101cm) from floor. Optional heights specify suffix -9, -10.
Door Thickness	1-3/4" (44mm) standard. 2" and 2-1/4" (51mm and 57mm) optional; specify when ordering.
Minimum Stile Width	4-1/2" (114mm)
Projection	3-1/4" (83mm) active, 2-3/4" (70mm) dogged
Latchbolt	Top: 3/4" (19mm) throw, pullman-type with automatic deadlatching Bottom: 5/8" (16mm) throw deadbolt, held retracted during door swing
Vertical Rods	1/2" (13mm) O.D. telescoping tubular rods
Strike	Top: Mortised 761. Bottom: Flush mounted 790. 794 floor strike optional (threshold openings).
Fasteners	Machine screws and wood door fasteners standard for panic hardware. Sex nuts and bolts supplied standard for fire exit hardware.
Trims	620F series escutcheon trim, 630F series pull/thumbpiece trim, 680F series offset pull trim, 540F series rose trim. See pages 22-24.
ANSI/BHMA	Certified A156.3 Type 7 and 8, Grade 1
UL/cUL	FVSR/FVSR7 - Panic hardware; GXHX/GXHX7 - Fire exit hardware (F) (8' x 10' pairs, 1-1/2 hr.) (8' x 8' pairs, 3 hr.)
Dogging	Hex key dogging supplied standard on panic devices
Options	Cylinder dogging, shim kit #723, sex nuts and bolts, less bottom rod (LBR), -9, -10 opening height, rod extensions, bottom pullman latch (panic only), MicroShield®, Lumi-lite.
Warranty	5-year limited



7220 Concealed Vertical Rod



The 7220 is a narrow stile concealed vertical rod exit device to be used on narrow stile, aluminum and metal doors where two-point latching is desired.

Features

- Designed for narrow stile doors
- Handed. Specify hand (field reversible)
- Bottom deadbolt for secure latching
- Fully adjustable roller strike

Applications

- Pairs of narrow stile doors
- Metal and aluminum doors
- For panic-rated doors only



Specifications

Door Opening Width	-24 for 24" (60cm) doors -36 for 30" - 36" (76cm - 91cm) doors -48 for 36" - 48" (91cm - 122cm) doors Optional sizes can be special ordered. Consult Technical Product Support.
Door Opening Height	Standard top rod adjustable to 7' to 8' (213cm to 244cm), with the device centerline at 39-15/16" (101cm) from floor. Optional heights specify suffix -9, -10
Door Thickness	1-3/4" (44mm) standard. 2" (51mm) and 2-1/4" (57mm); specify when ordering.
Minimum Stile Width	2" (51mm).
Projection	3-1/4" (83mm) active, 2-3/4" (70mm) dogged
Latchbolt	Top: 3/4" (19mm) stainless steel throw, pullman-type with automatic deadlatching. Bottom: 5/8" (16mm) throw deadbolt, held retracted during door swing.
Vertical Rods	1/2" (13mm) O.D. telescoping tubular rods
Strike	Top: Roller type 791. Bottom: Flush mounted 790. 794 floor strike optional (threshold openings).
Fasteners	Machine screws standard for panic hardware.
Trims	500F series escutcheon trim, 510F series pull/thumbpiece trim, 480F series offset pull trim. See pages 25-26.
ANSI/BHMA	Certified A156.3 Type 6, Grade 1
UL/cUL	FVSR/FVSR7 - Panic hardware
Dogging	Hex key dogging supplied standard
Options	Cylinder dogging, shim kit #723NS, sex nuts and bolts, -9, -10 opening height, rod extensions, bottom pullman latch, MicroShield®, Lumi-lite
Warranty	5-year limited





7220M(F) Concealed Vertical Rod

The 7220M(F) is a narrow appearance concealed vertical rod exit device for wide stile and flush metal doors only and is to be used where two-point latching is desired.

Features

- Narrow stile look designed for wide stile doors
- Handed. Specify hand (field reversible)
- Bottom deadbolt for secure latching
- Fully adjustable roller strike

Applications

- Pairs of doors
- Double egress
- Metal doors only



Specifications

Door Opening Width	-24 for 24" (60cm) doors -36 for 30" - 36" (76cm - 91cm) doors -48 for 36" - 48" (91cm - 122cm) doors Optional sizes can be special ordered. Consult Technical Product Support.
Door Opening Height	Standard door height adjustable to 8' (244mm), with the device centerline at 39-15/16" (101cm) from floor. Optional heights specify suffix -9, -10 (panic only).
Door Thickness	1-3/4" (44mm) standard. 2" (51mm) and 2-1/4" (57mm); specify when ordering.
Minimum Stile Width	4-1/2" (114mm)
Projection	3-1/4" (83mm) active, 2-3/4" (70mm) dogged
Latchbolt	Top: 3/4" (19mm) stainless steel throw, pullman-type with automatic deadlatching. Bottom: 5/8" (16mm) throw deadbolt, held retracted during door swing.
Vertical Rods	1/2" (13mm) O.D. telescoping tubular rods.
Strike	Top: Roller type 791. Bottom: Flush mounted 790. 794 floor strike optional (threshold openings).
Fasteners	Machine screws and wood door fasteners standard for panic hardware. Sex nuts and bolts supplied standard for fire exit hardware.
Trims	500F series escutcheon trim, 510F series pull/thumbpiece trim, 480F series offset pull trim. See pages 25-26.
ANSI/BHMA	Certified A156.3, Type 8, Grade 1
UL/cUL Listed	FVSR/FVSR7 - Panic hardware; GXHX/GXHX7 - Fire exit hardware (F) (8' x 8' pairs, 3 hr.)
Dogging	Hex key dogging supplied standard on panic devices
Options	Cylinder dogging, shim kit #723NS, sex nuts and bolts, bottom pullman latch (panic only), -9, -10 opening height, rod extensions, MicroShield®, Lumi-lite
Warranty	5-year limited





Escutcheons

480F Series	500F Series	510F Series	620F/650F Series	630F/660F/670F Series	680F Series
Projection: 2-13/32" (61mm)	Projection: see levers	Projection: see levers	Projection: see levers	Projection: 2-1/8" (54mm)	Projection: see levers

Roses

540F Series



Projection: 3-1/2" (89mm)

Standard Trims





























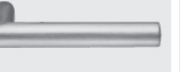



All Yale exit device trims (except mortise trim) feature the unique Free-Wheeling lever mechanism, similar to our 5400LN cylindrical lock. This Free-Wheeling trim features a clutch mechanism which allows the lever to float down 60 degrees when operated in the locked condition, improving vandal resistance.

Arcadia AR	Augusta AU	Carmel CR
Projection: 3-1/4" (82mm)	Projection: 2-5/8" (61mm)	Projection: 3-1/8" (79mm)
Jefferson JN	Monroe MO	Pacific Beach PB
Projection: 2-9/16" (65mm)	Projection: 3" (76mm)	Projection: 3-5/16" (84mm)
Pinehurst PN	Virginia VI	Hampton HA
Projection: 3-1/16" (78mm)	Projection: 3-1/8" (79mm)	Projection: 3-3/8" (86mm)

Note: Projection dimensions are provided using the 620F series escutcheon plates.

Reflections® Levers



Hudson	TB  Projection 3-1/16" (78mm)	UB  Projection 3-1/4" (83mm)	TC  Projection 3" (76mm)	TD  Projection 3-7/16" (87mm)	UC  Projection 3-7/16" (87mm)	
Spree	RS  Projection 3-1/8" (79mm)	RT  Projection 3-1/8" (79mm)	RU  Projection 3-13/32" (87mm)	RV  Projection 3" (76mm)		
Seine	TE  Projection 3" (76mm)	TG  Projection 2-13/16" (61mm)	TI  Projection 3-3/8" (85mm)	TO  Projection 3-1/2" (89mm)	TJ  Projection 3-1/16" (78mm)	TK  Projection 3-1/4" (83mm)
Thames	TM  Projection 3-1/16" (78mm)	TN  Projection 3-1/16" (78mm)	TP  Projection 3-5/16" (84mm)	TR  Projection 3-1/16" (78mm)	TS  Projection 3-1/8" (80mm)	TQ  Projection 3-1/16" (78mm)
Victoria	TT  Projection 2-11/16" (68mm)	TU  Projection 3-1/4" (83mm)	TV  Projection 3-1/2" (89mm)	TW  Projection 3" (76mm)	UW  Projection 3-7/16" (87mm)	TX  Projection 3-5/8" (92mm)
Victoria, continued	UX  Projection 3-7/16" (87mm)	TY  Projection 3-5/16" (84mm)	TZ  Projection 3-7/16" (87mm)			
Niagara	MA  Projection 2-13/16" (71mm)	RA  Projection 3-11/16" (94mm)	RB  Projection 2-13/16" (71mm)	RC  Projection 2-13/16" (71mm)		

Note: Projection dimensions are provided using the 620F Series escutcheon plates.

Note: The following Reflections levers are not available in 629 or 630 finish: Victoria TT, TU, TV, TW, TX, TY, UW, UX, TZ; Seine TG, TJ, TK, TO, TE, TI. Please consider the 618 or 619 finish as an alternative. Reflections levers are not available with knurling option.

7100 Series Trims



620F and 650F Series Escutcheon Trim



- Certified ANSI/BHMA A156.3, Grade 1.
- Trim thrubolts to exit device for strength.
- Beveled sides improve attack resistance.
- Solid forged escutcheon and Free-Wheeling trim resists vandalism and abuse.
- Flush cylinder in 6-pin applications for additional security.
- 1-3/4" (44mm) door standard. For doors through 2-1/4" (57mm) or shim-mounted devices, specify on order.
- Dimensions: 3" x 10-1/4" x 13/16" (76mm x 260mm x 19mm).
- Cylinders not included. See page 45-48 for cylinder options. 1-1/2" mortise cylinder required for mortise trim.
- Available with AR, AU, CR, JN, MO, PB, PN, VI and HA lever designs. See page 22.
 - Finishes: 605, 606, 609, 611, 612, 613E, 616, 619, 620, 626, 629, 630, 693, BSP
- Available with Reflections® lever designs. See page 21.
 - Finishes: 605, 606, 611, 612, 613E, 619, 626, 629, 630, BSP
- Trim ordering example: AU626F x 626 x RHR.
- 5-year limited warranty.

Application	Cylinder	Classroom/ Storeroom Cylinder Controls Thumbturn	Exit Only Blank Plate	Nightlatch Access by Key	Classroom Cylinder Controls Lever	Storeroom Cylinder Controls Lever	Nightlatch Cylinder by Lever	Passage	Dummy Trim Free- Wheeling	Dummy Rigid Lever
7100(F) 7150(F) 7110(F) 7120(F) 7160(F) 7170(F)	Rim	603F ¹	620F	621F ²	626F	626F ¹	627F ²	628F	628F ¹	629F
7130(F)	Mortise	—	620F	651F	656F	—	656F	658F	—	658F
7100(F)-2 7150(F)-2	Rim x Rim	—	—	—	626F	—	—	—	—	—
7130(F)-2	Mortise x Rim	—	—	—	656F	—	—	—	—	—
ANSI		11/12	01	03	08	09	03	14	02	02

1. 09, 12 and Free Wheeling 02 achieved with single trim modification at installation.
 2. Not recommended for use with vertical rod devices.
 3. 08 only
 For 626, 629 & 630 finishes the escutcheon is plated to simulate stainless steel.
 For 629 & 630 finishes the standard levers are plated to simulate stainless steel.
 Free-Wheeling is not available on mortise trim.
 For 620F series trim, optional door thickness available up to 4-1/2", specify on order.

7100 Series Trims



630F, 660F and 670F Series Pull/Thumbpiece Trim



- Certified ANSI/BHMA A156.3, Grade 1.
- Trim thrubolts to exit device for strength.
- Beveled sides improve attack resistance.
- Flush cylinder in 6-pin applications for additional security.
- 1-3/4" (44mm) door standard. For doors through 2-1/4" (57mm) or shim-mounted devices, specify on order.
- Plate Dimensions: 2-3/4" x 15-1/2" x 5/8" (70mm x 394mm x 16mm).
- Pull Dimensions: 6-7/16" (164mm) on centers x 2-1/8" (54mm) projection.
- Cylinders not included. See page 49-52 for cylinder options. 1-1/2" mortise cylinder required for mortise trim.
- Finishes: 605, 606, 609, 612, 613E, 616, 619, 620, 626, 629, 630, 693, BSP
- Trim ordering example: 630F x 630
- 5-year limited warranty.

Applications	Cylinder	Exit Only Blank Plate	Nightlatch Access by Key	Nightlatch Cylinder by Pull	Classroom Cylinder Controls T-Piece	Storeroom Cylinder Controls T-Piece	Dummy Trim Pull Plate	Passage Active T-Piece
7100(F) 7150(F) 7110(F) 7120(F) 7160(F) 7170(F)	Rim	630F	631F ²	632F ²	633F	633F ¹	634F	635F
7100(F)-2 7150(F)-2	Rim x Rim	—	—	—	633F	—	—	—
7130(F)	Mortise	630F K5F	661F K5F	662F K5F	673F ³ T8F	—	634F K5F	675F ³ T8F
7130(F)-2	Mortise x Mortise	—	—	—	—	—	—	—
ANSI		01	03	03	05	06	02	15

1. 06 achieved with single trim modification at installation.
 2. Not recommended for use with vertical rod exit devices.
 3. Available for 1-3/4" thick doors only.
 For 630F series trim, optional door thickness available up to 4-1/2", specify on order.
 For 626, 629 & 630 finishes the escutcheon is plated to simulate stainless steel.

7100 Series Trims



680F Series Offset Pull Trim



- 1-3/4" (44mm) door standard. For doors through 2-1/4" (54mm) or shim-mounted devices, specify on order.
- Plate Dimensions: 3" x 10-1/4" x 13/16" (76mm x 260mm x 21mm)
- Pull Dimensions: 7-1/4" (184mm) on centers x 2-13/32" (61mm) projection.
- Trim thrubolts to exit device for strength.
- Beveled sides improve attack resistance.
- Flush cylinder in 6-pin applications for additional security.
- Cylinders not included. See page 49-52 for cylinder options. 1-1/2" mortise cylinder required for mortise trim.
- Finishes: 605, 606, 609, 611, 612, 613E, 616, 619, 620, 626, 629, 630, 693, BSP
- Trim ordering example: 681F x 630 x LHR
- 5-year limited warranty

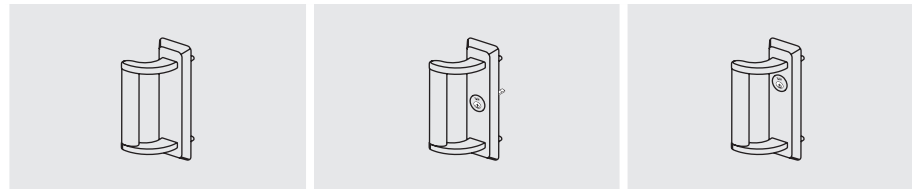

Applications	Cylinder	Dummy Pull	Nightlatch Access by Key	
7100(F) 7150(F) 7110(F) 7120(F) 7160(F) 7170(F)	Rim	680F	681F*	—
7130(F) 7130(F)-2	Mortise	—	—	684F
ANSI	—	02	03	—

*Not recommended for use with vertical rod exit devices.
For 626, 629 & 630 finishes the escutcheon is plated to simulate stainless steel.

7100 Series Trims



540F Series Rose Trim



- Certified ANSI/BHMA A156.3, Grade 1.
- 540F rose trim for stock doors.
- Trim thrubolts to exit device for strength.
- 1-3/4" (44mm) door standard. For doors through 2-1/4" (57mm) or shim-mounted devices, specify on order.
- AU, PB and MO trim designs. See below.
- Accepts cylindrical type cylinders. Cylinders included, see page 49 for cylinder options.
- Finishes: 605, 606, 609, 612, 613E, 616, 619, 620, 625, 626, 693, BSP
- "B" trim prefix - Lever trim accepting all small format interchangeable cores. 6- or 7-pin (Example: B-AU546F)
- "M" trim prefix - Lever trim accepting Medeco® (32 series) and ASSA® large format interchangeable cores. Available in AU lever only. 6-pin only. (Example: M-AU546F)
- "S" trim prefix - Lever trim accepting Schlage® standard cylinders. 6-pin only. (Example: S-AU546F)
- "SI" trim prefix - Lever trim accepting Schlage® large format interchangeable cores. 6-pin only. (Example: SI-AU546F)
- Please specify when ordering 1210 LFIC prep.
- 3-year limited warranty.

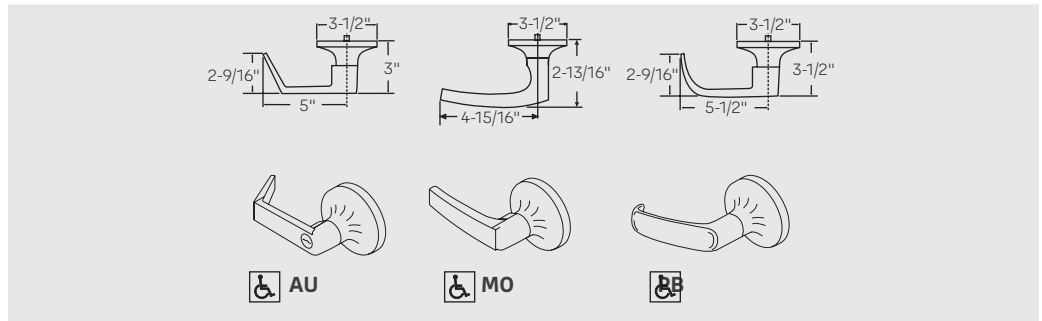

Applications	Nightlatch Access by Key	Classroom Cylinder Controls Lever	Passage Lever	Dummy Trim Free-Wheeling Lever	Dummy Trim Rigid Lever
7100(F), 7150(F), 7110(F), 7120(F), 7160(F), 7170(F)	541F*	546F	548F	548F	549F
ANSI	03	08	14	02	02

*Not recommended for use with vertical rod devices.

7200 & 7200M Series Trims



500F Series Escutcheon Trim



- Certified ANSI/BHMA A156.3, Grade 1.
- Trim thrubolts to exit device for strength.
- 1-3/4" (44mm) door standard. For doors through 2-1/4" (57mm) or shim-mounted devices, specify on order.
- Dimensions: 1-5/8" x 9-1/2" x 1/4" (41mm x 241mm x 6mm)
- Cylinders not included. See page 49-52 for cylinder options.
- Available with AR, AU, CR, JN, MO, PB, PN, VI and HA lever designs. See page 22-23.
 - Finishes: 605, 606, 609, 611, 612, 613E, 616, 619, 620, 626, 629, 630, 693, BSP
- Available with Reflections® lever designs. See page 23.
 - Finishes: 605, 606, 611, 612, 612, 613E, 619, 626, 629, 630, BSP
- Trim ordering example: AU506F x 626 x RHR.
- 1-year limited warranty.

Applications	Nightlatch Access by Key	Exit Only Blank Plate	Nightlatch Access by Key	Classroom/Storeroom Cylinder Controls Thumbturn	Classroom/Storeroom Cylinder Controls Lever	Passage	Passage or Dummy	Dummy Trim
7200, 7210, 7220, 7250, 7200M(F), 7210M(F), 7220M(F), 7250M(F)	121NL ²	500F	501F ²	503F ¹	506F ¹	507F	508F ¹	509F
ANSI	03	01	03	11/12	08/09	16	14/02	02

¹ 09, 12 and Free-Wheeling 02 achieved with simple trim modification at installation.

² Not recommended for use with vertical rod devices.

For 629 & 630 finishes the standard levers are plated to simulate stainless steel.

7200 & 7200M Series Trims



510F Series Pull/Thumbpiece Trim



- Certified ANSI/BHMA A156.3, Grade 1.
- Trim thrubolts to exit device for strength.
- 1-3/4" (44mm) door standard. For doors through 2-1/4" (57mm) or shim-mounted devices, specify on order.
- Plate Dimensions: 1-5/8" x 15-1/4" x 5/8" (41mm x 387mm x 16mm).
- Pull Dimensions: 6-7/16" (164mm) on centers x 2-1/8" (54mm) projection.
- Accepts rim cylinders. Cylinders not included. See page 45 for cylinder options.
- Finishes: 605, 606, 609, 611, 612, 613E, 616, 619, 620, 626, 629, 630, 693, BSP
- Trim ordering example: 512F x 630
- 1-year limited warranty.

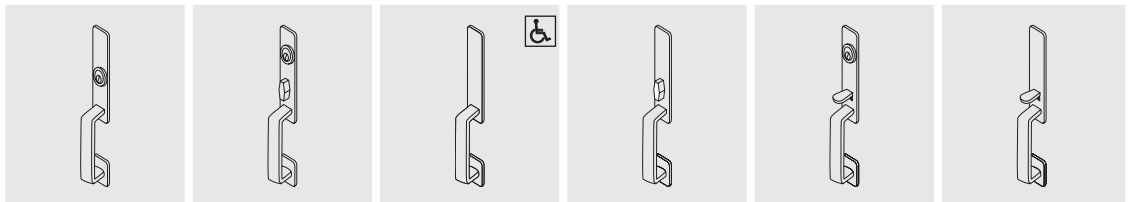

Applications	Nightlatch Access by Key	Classroom/ Storeroom Cylinder Controls Thumbturn	Dummy Trim	Passage	Classroom/ Storeroom Cylinder Controls T-Piece	Passage
7200, 7210, 7220, 7250, 7200M(F), 7210M(F), 7220M(F), 7250M(F)	512F*	513F	514F	517F	518F	519F
ANSI	03	11/12	02	16	05/06	15

*Not recommended for use with vertical rod devices.

^Not recommended for use with vertical rod devices.

7200 & 7200M Series Trims



480F Series Offset Pull Trim



- 1-3/4" (44mm) door standard. For doors through 2-1/4" (57mm) or shim-mounted devices, specify on order.
- Plate Dimensions: 1-3/4" x L x 3/16" (44mm x L x 5mm) L = Overall plate length is 2-1/4" (57mm) longer than pull dimension.
- Pull Dimensions:
 - 480F and 481F trim have a 7-1/4" (184mm) pull length on centers which thrubolts to exit device for strength.
 - 482F and 483F trim have a 9" (229mm) pull length on centers and are not to allow pulls of different lengths to be utilized. Longer lengths of 15" (381mm), 18" (457mm) and up to 30" (762mm) are available.
- 2-13/32" (61mm) projection.
- Cylinders not included. See page 45 for cylinder options.
- Finishes: 605, 606, 609, 611, 612, 613E, 616, 619, 620, 626, 629, 630, 693, BSP
- Trim ordering example: 481F x 630 x LHR
- 1-year limited warranty

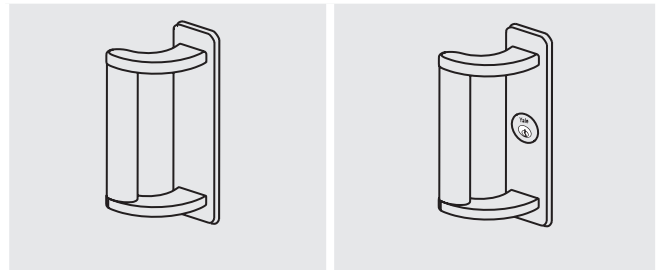

Applications	Cylinder	Dummy Pull	Nightlatch Access by Key
7200, 7210, 7220, 7250, 7200M(F), 7210M(F), 7220M(F), 7250M(F)	Rim	480F 482F	481F* 483F*
ANSI	--	02	03

*Not recommended for use with vertical rod exit devices.
For 626, 629 & 630 finishes the escutcheon is plated to simulate stainless steel.



Electrified Options

The Yale® 7000 Series exit devices offer a complete range of electrical options. A continuity in appearance, security and functions with the 7000 Series mechanical exit device is maintained. These electrified exit devices may be integrated into the monitoring security and alarm systems of most buildings.

Electrified Options

Model #	Exit Device Description	A	B	D	G	O	MELR	S	SAFE	SECURE	690F	691F
7100(F)	Rim Device (Wide)	x	x	x	x	x	x	x			x	x
7110(F)	Surface Vertical Rod (Wide)	x	x	x	x	x	x	x			x	x
7120(F)	Concealed Vertical Rod (Wide)	x	x	x	x	x	x	x				
7130(F)	Mortise Device (Wide)	x	x	x	x	x	x	x	x	x		
7150(F)	Rim SquareBolt® Device (Wide)	x	x	x	x	x	x	x			x	x
7150(F)WS	Rim SquareBolt Windstorm (Wide)	x	x			x	x	x			x	x
7160(F)	Concealed Vertical Rod (Wide)	x	x	x	x	x	x	x				
7170(F)	Surface Vertical Rod (Wide)	x	x	x	x	x	x	x			x	x
7170(F)WS	Surface Vertical Rod Windstorm (Wide)	x	x			x	x	x			x	x
7200(M)(F)	Rim Device (Narrow)	x	x	x	x		x	x				
7210(M)(F)	Surface Vertical Rod (Narrow)	x	x	x	x		x	x				
7220(M)(F)	Concealed Vertical Rod (Narrow)	x	x	x	x		x	x				
7250(M)(F)	Rim SquareBolt Device (Narrow)	x	x	x	x		x	x				

Electrified Hardware Option Descriptions

A	Alarm Option	S	Latchbolt Position Monitor
B	Touchbar Monitor	SAFE	Fail Safe Operation (Mortise)
D	Delayed Egress	SECURE	Fail Secure Operation (Mortise)
G	Electric Dogging	690F	Fail Safe Electrified Trim
O	Trim Monitor Switch	691F	Fail Secure Electrified Trim
MELR	Motorized Electric Latch Retraction		

Note: Any combination of the following options cannot be ordered together:

1) MELR, G, or D 2) B or A 3) D, B or A

*Only available for rim and SquareBolt® Devices when used with Delayed Egress option.

What normally took an hour or more to connect now takes minutes. Yale electrified exit devices and trims are equipped with ElectroLynx connectors. As a standard feature, these “plug & play” connectors link power from the incoming source to electrified locking products, including hinges, locks, exit devices, magnetic holders and strikes.

Note: Electrified door hardware with ElectroLynx connectors require a compatible number of lead wires attached to the door hinge.



Electrified Options



Motorized Electric Latch Retraction "MELR"

Operation

Allows the latchbolt to be retracted electrically for momentary or maintained periods of time from a remote location. The exit device bolt remains retracted for as long as the device is energized. Removal of power returns the device to the life safety, self-latching mechanical mode. Easy interface with central or local fire alarm systems, automatic door operators, hands-free actuation devices, and access control systems. Allows free egress at all times. Manual hex key dogging standard on non-rated devices. Not available on openings less than 30" wide.

Electrical Specifications

Solenoid Assembly

- 24VDC (BPS-24-1) regulated/filtered power supply. Requires 1A per device
- .65A amp max during retraction
- .2 amp holding-continuous duty

Listings

UL/cUL listed for panic and fire exit hardware. Fire-rated devices must be wired into an automatic fire alarm system. 

Applications

Rim: 7100(F), 7200, 7200M(F)
 SquareBolt®: 7150(F), 7250, 7250M(F)
 SVR: 7110(F), 7170(F), 7210, 7210M(F)
 CVR: 7120(F), 7160(F), 7220, 7220M(F)
 Mortise: 7130(F)

Ordering

Suffix "MELR" to the Model Number. Ex: 7100MELR.

Note: Not available on "A" alarm exit device and "D" delayed egress exit devices. Existing solenoid and mechanical devices can be retrofit to motorized electric latch retraction (MELR) by purchasing a retrofit kit, if the device was manufactured after April 2015.

List No.	Product Description	Available Options		
		WS	"O"	WS & "O"
RMELR-36	7100 36" MELR DEVICE ASSY	X	X	X
RMELR-38	7200 36" MELR DEVICE ASSY		X	
RMELR-48	7100 & 7200 48" MELR DEVICE ASSY	X	X	X

Latchhead Requirements

Existing solenoid and mechanical devices manufactured prior to April 2015 require the device assembly retrofit kit (see above) and a new latchhead. Refer to the 7000 Series Parts & Service Manual for latchhead replacement part numbers.

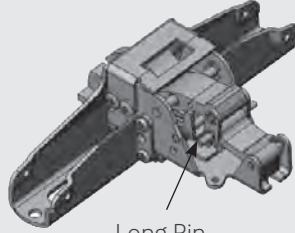
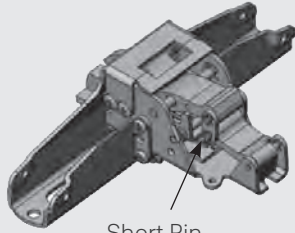
Latchhead Pins	Latchhead Pins
(Since April 2015 (17/15))	(Prior to April 2015 (17/15))
	
Long Pin	Short Pin

Note: Label with date code is located on front face of latch head.

Date Code Label Example

80-7710-0010-048
AAO
17/15

17/15 refers to 17th week of 2015.



Electric Dogging "G"

Operation

Provides continuous latch retraction and pushpad dogging simultaneously. When power is applied to the device, depressing the pushpad will retract the latchbolt and continuously hold down the pushpad in the unlock position for push/pull operation. Removal or interruption of power will release the pushpad and the latchbolt will extend and secure the opening. For use in areas that require quiet door operation.

Exit device allows free egress at all times.

Electrical Specifications

2 Holding Magnets

- .35 amps @ 24VDC
- Requires a 2-wire pivot or hinge and a standard 24VDC regulated and filtered power source (Recommended BPS power supplies)

Listings

UL/cUL listed for panic and fire exit hardware. 
Fire-rated devices must be wired into an automatic fire alarm system.

Applications

Rim: 7100(F), 7200, 7200M(F)
SquareBolt: 7150(F), 7250, 7250M(F)
SVR: 7110(F), 7170(F), 7210, 7210M(F)
CVR: 7120(F), 7160(F), 7220, 7220M(F)
Mortise: 7130(F)

Ordering

Suffix "G" to the Model Number. Ex: 7150G.

Note: Not available on "D" delayed egress exit devices.

Mortise Device Trim Control "Safe/Secure"

Operation

Allows the outside trim to lock or unlock electrically from a remote location. Exit device allows free egress at all times.

Fail Safe devices are commonly used in stair towers or locations that require the trim to unlock when power is removed or during fire alarm activation.

Fail Secure devices are used to secure openings and are usually integrated into the building security system to allow access control. Fail Secure trims remain locked when power is removed.

Electrical Specifications

Solenoid

- .35 amps @ 24VDC only (12 volt not available)
- Continuous duty
- Requires a 2-wire pivot or hinge and a standard 24VDC regulated and filtered power source (Recommended BPS power supplies)

Listings

UL/cUL listed for panic and fire exit hardware. 

Applications

Mortise: 7130(F) - lever functions only

Ordering

"Safe" – Maintains the outside trim in a locked state when energized. Removal of power unlocks outside trim.

"Secure" – Unlocks the outside trim when energized. Remains locked when power is removed.

Suffix "SAFE" or "SECURE" to the Model Number.

Ex: 7130 x L5 x Safe.

Electrified Options



Delayed Egress "D"

Operation

An exit door is normally closed and latched. The delayed egress device secures the door in the locked mode with the Red LED indicating locked mode status. Depressing the pushpad for less than three seconds will cause the device to beep without initiating the alarm. Depressing the pushpad for three seconds or longer will initiate an irreversible local audible beeping tone and a visual amber indicator. The person depressing the pushpad is denied egress for 15 or 30 seconds while alarm signals unauthorized egress. After the factory-set delay time (15 or 30 seconds), the device releases for egress, the LED changes to Green and the beep changes to a steady tone which continues to alarm until reset. The remote monitoring contact outputs can be used to alert security personnel.

Note: The 15-second time delay is standard. (Optional 30-seconds may be accepted by local jurisdiction.)

Electrical Specifications

- Input Voltage 24VDC (+/- 10%)
Power Consumption:
- Standard Device: 500 mA
- Device with Safe/Secure Electric Mortise or Electric Trim Control: 1.5 Amps.

Certifications & Listings

UL/cUL Listed: FUKD/FUKD7 - Controlled Exit Panic Devices 

FWAX/FWAX7 - Special Locking Arrangements

GXHX/GXHX7 - Fire Exit Hardware

ANSI/BHMA Certified: A156.3 & A156.24 

U.S. Patent #: 7,469,942

Applications

- For use on hollow metal interior or exterior doors.
- Available for 7100(F), 7200M(F) and 7200 series rim, SquareBolt®, surface vertical rod, concealed vertical rod and mortise panic and fire-rated exit devices. For surface vertical rod exit devices, rod and latch guards (provided by other) must be used.
- Complies with NFPA 101 "Code For Safety To Life From Buildings And Structures" by National Fire Protection Association.
- BOCA options available to comply with National Building Code requirements. BOCA option is not suitable for installations in accordance with NFPA 101.
- 1-3/4" door thickness standard; 2" and 2-1/4" optional; specify when ordering.
- Standard 36" device fits doors 35"- 36" Device cannot be cut less than 35".
- Option -48 fits doors 41"- 48". Devices cannot be cut less than 41".

Standard Features

Key Switch Operation:

- Normal: The system is armed by applying power to the device (solid Red LED). Depressing the pushpad for more than the nuisance delay time starts the exit delay cycle.



- Bypass: Turning the key switch clockwise to the bypass position allows immediate egress without alarming. The bar functions as a standard exit device (Red LED flashes slowly).
- Reset/Delay: Used to reset device after the factory-set 15 or 30-second delay cycle has timed out.
- Rearm: If the device is armed, turning the key counterclockwise to the reset mode will release the device without alarm for egress and will rearm after 10 seconds (Red LED flashes quickly).

Local Visual Status Indicator:

- RED: The exit device is secure and the delayed egress circuitry is energized.
- AMBER: The egress cycle has started, indicated by an irreversible local audible beeping tone.
- GREEN: The exit device is in alarm and has released.

Nuisance Delay Time:

- Depressing the pushpad for less than three seconds sounds an audible beep without activating the irreversible alarm sequence. (Immediate alarm can be selected by removing a jumper on the control board.) Nuisance Delay Times are dip switch selectable to Immediate, 1, 2, or 3 (default) seconds on the control board.

Internal Alarm Siren:

- When armed, depressing the pushpad initiates the internal 85db alarm siren.

Door Position Switch (DPS) Control Board input:

- Allows external DPS wiring to control board for higher security. Alarm sounds when the DPS contacts open when the door is forced open.

Remote Control Inputs:

- Remote Reset: Accepts a momentary contact (keyswitch, pushbutton, etc) to reset the unit during alarm or allows momentary egress (selectable 5, 10 (default), 20 or 40 seconds) when the unit is armed.
- Remote Bypass: Accepts a momentary contact to put the unit in a maintained bypass operation. The exit device functions as a standard device.

Alarm Outputs:

- Contacts change only during alarm status. One set of Alarm Relay Output contacts change state when device delay cycle has started (Alarm). Contacts are selectable for Normally Open (N.O.) or Normally Closed (N.C.) using the 2-pin jumper on the control board. N.O. is default setting. One set of contacts changes when device has released (Secure). Secure Relay Output has two sets of contacts (N.O. and N.C.). The Alarm Relay and Secure Relay contacts are SPDT type, rated 1A @24VDC.

Door Sign:

- Door sign per code included.



Electrified Options

Delayed Egress "D" (cont.)

Rearm After Closing (RAC)

Works in conjunction with an external DPS wired to the Control Board. Field selectable settings:

Setting 1 :

If the door is open beyond the momentary egress or remote reset time the device will Alarm.

Setting 2:

If the door is open beyond the momentary egress or remote reset time the device will remain in egress mode indefinitely until the door closes (will not Alarm).

Options

Latchbolt Position Monitor "S":

- Used to monitor the positions of the latchbolt or vertical rods (SPDT switch).
- To order, suffix "S".
- See page 32 for more information.

Trim Monitor Switch "O":

- Used when outside trim is desired. This switch will allow Bypass (disarms device) when the trim is used for ingress. The device will need to be reset upon entry by means of the keyswitch on the device or a remote switch.
- To order, suffix "O".

NFPA 101 Requirements:

15- & 30-Second Delay

- Upon depressing the pushpad for 3 seconds, the delayed egress device will sound an audible beeping tone and allow the door to be opened after 15 (or 30) seconds. The tone will then change to a continuous alarm until reset. Resetting of the alarm and re-arming of the device is accomplished by manual means only.
- To order, specify NFPA 15-second or NFPA 30-second.
- Purchase orders that do not have an option noted will default to the NFPA 15-second delay.
- NOTE: Where approved by the authority having jurisdiction, a delay not exceeding 30 seconds shall be permitted.

BOCA Requirements:

15- & 30-Second Delay

- Upon depressing the pushpad for 1 second, the delayed egress device will sound an audible beeping tone and allow the door to be opened within 15 (or 30) seconds. The tone will then change to a continuous alarm until reset. Resetting of the alarm and re-arming of the device occurs automatically once the door has been returned to the closed position for 30 seconds. The 30-second re-arming timer will re-start if the pushpad is depressed or the door is re-opened before actual re-arming of the device occurs. A DPS (Door Position Switch) is required for the BOCA option.
- To order specify BOCA 15-second or BOCA 30-second.
- Purchase orders that do not have an option noted will default to the NFPA 15-second delay.
- NOTE: An increase in the egress delay to 30 seconds shall not be permitted except as approved by the authority having jurisdiction.

Electric Trim Control - "SAFE" or "SECURE":

- The mortise delayed egress exit device can be ordered with fail safe or fail secure outside trim operation. In a fire condition the fail safe trim will release for entry. When access control is used the fail secure trim allows entry by means of a remote card reader, keyswitch, pushbutton, etc.
- To order, suffix "Safe" or "Secure".
- NOTE: The trim will open the door without affecting the device in an armed condition, if a door position switch is not used.

Required Accessories

Power Supply:

A regulated and filtered power supply with a fire alarm interface is required. 1 Amp minimum @ 24VDC per device. Special options will require more amperage. Consult factory. Recommend: BPS series.

Power Transfer:

Allows the power cable to make the transition from frame to door without pinching or removal of insulation.

Cylinders

Utilizes a 1-1/8" mortise cylinder with a 2160 cam. Cylinder not included unless specified. See page 45-48.

Ordering

Suffix "D" after device.
Example: 7150FD

Refer to McKinney Power Transfer Device catalog for ElectroLynx options.

ElectroLynx® Power Transfer Device Options		
Hinge	External DPS	Options
QC8	Not required	None
QC12	Required	S, or O, or Safe/Secure Options

Electrified Options



Alarm Kit "A"



Activation: Alarm is armed by turning key clockwise. Low audible chirp indicates alarm has been activated. Alarm will sound when the exit device pushpad is depressed. Factory preset for standard alarm mode which automatically resets after 5 minutes.

Continuous Alarm Mode: Alarm sounds continuous when the exit device pushpad is depressed. Alarm must be manually reset by keyswitch. (This feature is selected by a switch on the circuit board.)

Low Battery Warning: Audible chirp.

Nuisance Alarm: Factory preset for instant alarm. Selectable feature for alarm to sound when pushpad is depressed for more than 2 seconds. (This feature is selected by a switch on the circuit board.)

Arming Delay/Authorized Egress: 10-second delay (after arming) permitting egress (by turning key clockwise).

Alarm Shunt: Ingress shunt alarm input for devices with latchbolt position (S) monitor. NOTE: "S" included with SVR devices.

Power Requirements: One 9-volt battery (included).

Loudness: 90db @ 10 feet.

Arm/Disarm: Uses one 1-1/8" straight cam mortise cylinder. Clockwise turn arms the alarm, counter clockwise turn disarms or silences the alarm.

Device Status: A Red LED indicator will illuminate every 30 seconds when the alarm is armed.

Tamper Resistant: Built-in safety monitor sounds alarm when tampering occurs.

Warning Decal: "EMERGENCY EXIT - ALARM WILL SOUND"

Applications: Rim: 7100(F), 7200, 7200M(F); SquareBolt®: 7150(F), 7250, 7250M(F); SVR: 7110(F), 7170(F), 7210, 7210M(F); CVR: 7120(F), 7160(F), 7220, 7220M(F); Mortise: 7130(F)

Kit: Available in kit form for field retrofit.

Bar Length: Available for 36"- 48" devices only. May not be used on bars less than 36".

- Standard 36" device fits doors 35"-36" Device cannot be cut less than 35".
- Option -48 fits doors 41"- 48". Devices cannot be cut less than 41".

How to Order: Specify 7116 for alarm kit. Suffix -"A" when ordering with device. Ex: 7150-A.

NOTE: The 7116 alarm kit cannot be retrofitted in the field to the 7110(F), 7170(F), 7210 or 7210M(F) surface vertical rod exit devices. This option is available as a factory order only for these devices. Any attempt to retrofit the 7116 alarm kit with these surface vertical rod exit devices will void the warranties for these products.

Electric Trim

The electrified 600 series heavy-duty trim provides electric locking and unlocking of trim. Ideal for door control where increased security is necessary at all times, while meeting life safety codes. Electric trim is ideal for many applications, including stairwell towers, high-security areas, schools, hospitals, and factories.



Functions

690F Trim - Fail Safe

- Lever is locked when power is on (Free-Wheeling)
- Power off allows entry from trim
- Inside device is always active for egress
- Mechanical key override (09 Function - Key allows lever to retract latchbolt. Key can only be removed in locked position)

691F Trim - Fail Secure

- Lever is locked when power is off (Free-Wheeling)
- Power on allows lever activation for entry
- Inside device is always active for egress
- Mechanical key override (09 Function - Key allows lever to retract latchbolt. Key can only be removed in locked position.)

Features

- Accepts all standard and Reflections® decorative lever designs
- Plug connector with 4' wire lead (Exit device is used as wire raceway, not door)
- Key Override - Requires rim cylinder (sold separately)

Applications

- 7100(F) Rim Device
- 7150(F) SquareBolt®
- 7110(F), 7170(F) Surface Vertical Rod

Electrical Specifications

- 330 mA @ 24 Volts
SM - Security Monitor Switch
- 4 AMP @ 250VAC
Voltage: 24 VAC/VDC only
BPS series power supplies recommended.

Options

- SM - Security Monitor. A SPDT switch that monitors the position of the solenoid (lock and unlock status).
- EX - Trim gasket for exterior applications.



Electrified Options

Touchbar Monitor "B"

Provides indication of the pushpad being depressed. Used as a Request to Exit switch to shunt alarm systems, release electromagnetic locks or monitor egress.

Electrical Specifications:

2A @ 28VDC
SPDT contacts

Listings: UL/cUL listed for panic and fire exit hardware.

Applications: Rim: 7100(F), 7200, 7200M(F)
SquareBolt®: 7150(F), 7250, 7250M(F)
SVR: 7110(F), 7170(F), 7210, 7210M(F)
CVR: 7120(F), 7160(F), 7220, 7220M(F)
Mortise: 7130(F)

Ordering: Suffix "B" to the Model Number. Ex: 7120B.

Note: Not available on "D" Delayed Egress devices or with the "A" Alarm kit option.

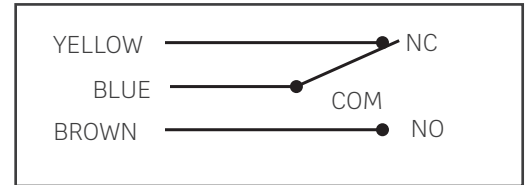

Latchbolt Position Monitor "S"

Provides indication on the position of the latchbolt. Used with security systems to monitor the latchbolt, also used to activate automatic door operators upon latch retractions.

Electrical Specifications:

2A @ 28VDC
SPDT contacts

Listings: UL/cUL listed for panic and fire exit hardware.

Applications: Rim: 7100(F), 7200, 7200M(F)
SquareBolt®: 7150(F), 7250, 7250M(F)
SVR: 7110(F), 7170(F), 7210, 7210M(F)
CVR: 7120(F), 7160(F), 7220, 7220M(F)
Mortise: 7130(F)

Ordering: Suffix "S" to the Model Number. Ex: 7120S.

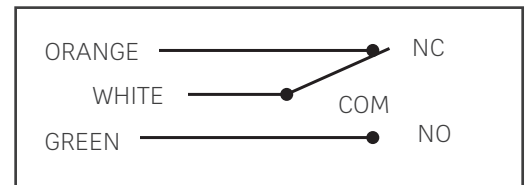

Trim Monitor Switch "O"

Provides indication of the trim being operated from the outside. Used as a Request to Enter signal switch to shunt alarms, also used to monitor entry.

Electrical Specifications:

2A @ 28VDC
SPDT contacts

Listings: UL/cUL listed for panic and fire exit hardware.

Applications: Rim: 7100(F)
SquareBolt®: 7150(F)
SVR: 7110(F), 7170(F)
CVR: 7120(F), 7160(F)
Mortise: 7130(F)

Ordering: Suffix "O" to the Model Number. Ex: 71500.

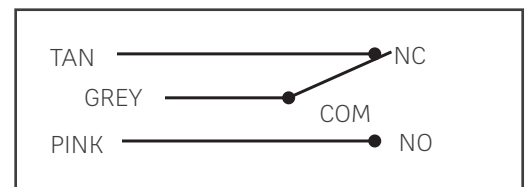

Electrified Options



Stand Alone Door Alarm SDA16

The SDA16 stand-alone battery operated door alarm is designed to continually monitor the status of a door. When the door is opened without authorization, an alarm is triggered to alert the security violation. This alarm features a Peizo horn which blasts a deafening 105+ decibels to alert the violation.



This unit is ideal for emergency doors as well as stairwell doors and rear exit doors in retail environments. The unit, which can also be hardwired, easily complements existing hardware, making any opening alarmed. The SDA16 door alarm is typically mounted on the interior of the door frame or door and is paired with a magnet mounted on the opposing side of the door gap.

Features

- Dimensions: 8.3"L x 3.1"W x 2.0"D (210mm L x 79mm W x 52mm D)
- Non-handed unit (field reversible)
- Unit powered by 9V battery
- Unit can be hardwired by using WH-11 wire harness and 784 power supply
- No battery is required in unit with hard-wire option – if power is lost, optional gel-cell battery in power supply will give approximately 10,000 operations
- Reverse battery protection safeguards the unit if the battery is incorrectly installed
- A low-voltage battery is indicated by an audible signal every 30 seconds
- Piezo horn blasts at 105+ decibels if the door is used with out proper authorization
- The LED will flash every 30 seconds, indicating either the unit is armed or, if under auto reset, that the door has been violated
- Various field-adjustable features by dip switch including automatic alarm reset, REX and passage time delay, and LED color preference
- A tamper switch provides instantaneous signal to sound horn in the event the cover is removed. Horn will sound until the unit is reset by the key or remote reset/arm switch
- Conformally coated electronics for weather resistance
- Cover is held in place by cam lock which protects mounting screws, electrical system and internal sensors
- Accepts external cylinder (not included, must be specified)
- Accepts standard mortise cylinders (not included, must be specified)

Remote Mounting

The SDA16 can be installed remotely from the door by attaching the contacts to the door and frame. The unit can be installed up to 6 feet from the door. This provides the ideal solution for circumstances where exposure to weather may be an issue. To order specify "SDA16XL".

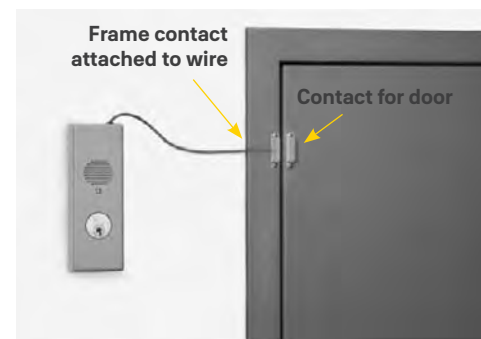

Note: Actual wire length is 6 feet.

Cylinders and Accessories

- 784 Power supply (9VDC) – includes plug-in wall transformer
- Plug-in wall transformer with 12' cable assembly (part no. 00-0000-3425)
- Gel-cell battery – optional for use with 784 power supply (part no. 00-0000-3426)
- WH-11 Wire harness for remote power and remote unlock
- Mortise cylinder for unit
- Rim cylinder for outside control
- See pages 45-48 for cylinder information.



Electrified Options

782 Power Control



Operation

Designed to control one or two electric latch retraction "P" exit devices. Equipped with two 20-second timers which can operate the exit devices together or independently. Requires a momentary or timed, dry contact input and can be interfaced with access control systems, automatic door operators, "blow open" type scenarios and has provisions for N/C fire alarm systems.

Note: The 782 is required for use with the "P" latch retraction option. Using any other power supply with the "P" option voids the warranty of the device.

Features

- Two control inputs. Accepts normally closed dry contacts for device activation from a key switch, push button, access control or fire alarm system.
- Two normally open control outputs for automatic door operators
- Two "P" device outputs
- Fire Alarm Interface input
- 24VDC output for audible or LEDs .25 AMP

Electrical Specifications

- 120 VAC 60Hz 750mA (max.)
- Not available in 240V
- 38-42 VDC output
- 10 amp inrush

Listings

- UL 294 
- UL CLASS 2 outputs

Applications

"P" Electric Latch Retraction Option (not required with standard MELR option)

Ordering

782 Controller

Note: This part will no longer be listed as a sellable item for use with the 7000 Series exit device as of December 15, 2020.

Yale recommends McKinney®, Pemko and Securitron® for power transfer devices and other electronic accessories.

BPS Power Supplies By Securitron®

Operation

Power supplies are designed to provide reliable filtered and regulated power for long life to a variety of electrified hardware components.

Note: The BPS is required for use with the "MELR" latch retraction option. Using any other power supply with the "MELR" option voids the warranty of the device.

Product Features

- Individual output circuit breakers
- Regulated and filtered fuse protected outputs
- LEDs monitor zone status (voltage or no voltage)
- Slide switches connect or disconnect load from power (Not available on 1 Amp supplies)
- Internal Back-Up battery charging circuit
- Rugged steel enclosure
- Fire alarm interface

Listings

- UL CLASS 2 

Applications (use with):

- D – Delayed Egress
- G – Electric Dogging
- Safe – Fail Safe mortise device trim control
- Secure – Fail Secure mortise device trim control
- 690/691 – Electric Trim

Ordering

Ex: BPS-24-4

Model	Input	Output	Application
BPS-24-1	120 VAC	1 Amp @ 24 VDC	1 "D"
BPS-24-2	120 VAC	2 Amp @ 24 VDC	2 "D" or 1 "D" with Safe or Secure
BPS-24-4	120 VAC	4 Amp @ 24 VDC	4 "D" or 3 "D" with Safe or Secure

Consult factory for additional power supply applications.



Motorized Electric Latch Retraction

Motorized Electric Latch Retraction Interfaced with an Automatic Door Operator

Components

- 7100MELR Latch Retraction
- Automatic Door Operator by Norton®
- ADA Pushbuttons #671 by Norton
- QC8 Power Transfer Hinge by McKinney®
- 700 Wave to Open Switches by Norton

Operation

Exit device allows free egress at all times.

Activating the interior or exterior pushbutton retracts the latchbolt in the device and the door automatically opens. Door closes and relatches after hold open time has elapsed in the operator.

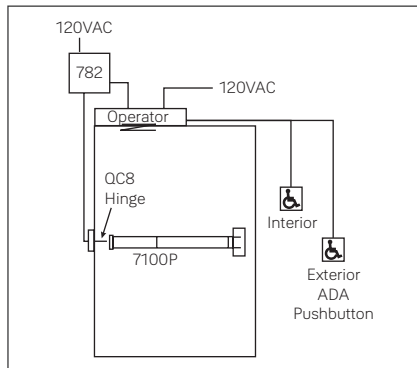

Electric Dogging

Electric Dogging with Monitor Functions

Components

- 7100GBS Electric Dogging Device with Touchbar Monitor
- BPS Power Supply with fire alarm interface
- Keyswitch with a Red and a Green LED
- DPS (door position switch) by Securitron®
- QC12 Power Transfer Hinge by McKinney®

Operation

Exit device allows free egress at all times.

Activating the maintained keyswitch applies power to the 7100GBS device. The first mechanical depression of the pushpad will retract the latchbolt and hold the pushpad down in a dogged position. Fire alarm activation, interruption of power or turning the keyswitch off will release the pushpad and the latch will extend.

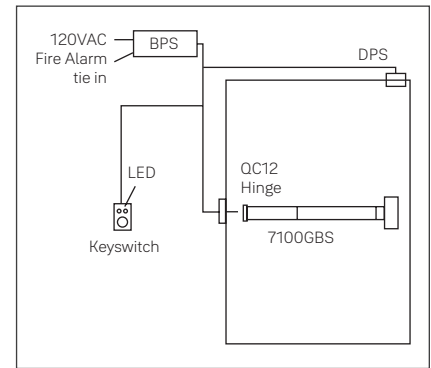

- The Green LED illuminates when power is on, and the pushpad can be depressed and dogged.
- The Red LED illuminates when power is off, the door is closed and the device is latched and secure.

Monitor Functions

Motorized Electric Latch Retraction with Monitor Functions

Components

- 7100MELRBOS, Exit Device with Touchbar, Outside Trim and Bolt Position Monitors
- Momentary Pushbutton with Red and Green LED
- DPS (door position switch) by Securitron®
- TSB-C Door Cord by Securitron®

Operation

Exit device allows free egress at all times.

Activating the 402 x L2 push button retracts the latchbolt from a remote location.

- The Red LED indicates that the door is closed and latched.
- The Green LED illuminates when any of the following situations occur:
 - The pushpad is depressed
 - Tampering or retraction of the latchbolt
 - Operation of outside trim
 - Opening of door

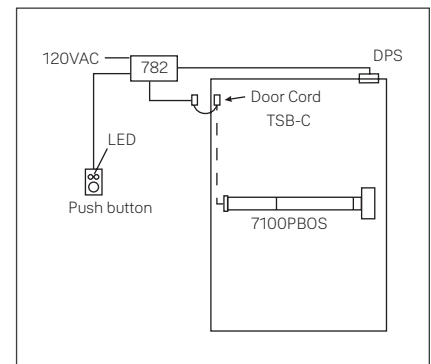

Electrified System Guide

Monitor Functions

Rim Exit Device with High Security Application

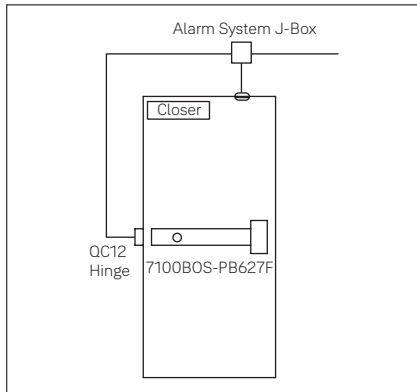

Components

- 7100 - PB627F Nightlatch Trim - Yale®
- S Bolt Position Monitor Switch
- B Pushpad Monitor Switch
- O Trim Monitor Switch
- Door Position Switch - Securitron®
- QC12 Power Transfer Hinge by McKinney®
- Surface Door Closer - Yale

Operation

Operation of the 7100 Exit Device with the S, B, O and ASSW-104A can be used together or individually to sound an alarm, shunt an alarm, monitor the door's security or as a "Request to Exit" in conjunction a magnetic lock.

Electric Trim

Rim Exit Device with Electrified Trim

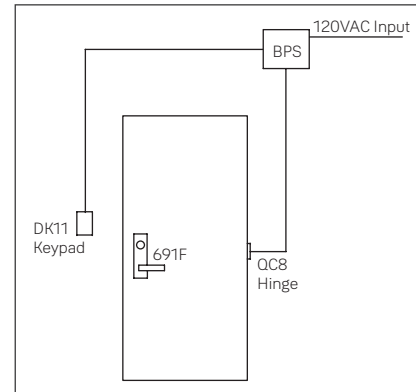

Components

- 691F Electrified Trim - Yale
- 7100 Rim Exit Device - Yale
- Digital Keypad by Securitron®
- QC8 Power Transfer Hinge by McKinney®
- BPS Power Supply

Operation

Operation of the Digital Keypad will allow keyless entry from the non-protected side of the opening. When a valid code is entered into the keypad, voltage will be applied to the trim, making the lever active and allowing ingress. Free exit is allowed by using the exit device from the protected side of the door.

Delayed Egress

Rim Exit Device with Delayed Egress Option on "Exit Only" Door

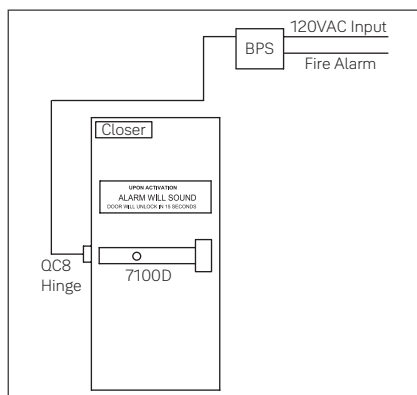

Components

- 7100D Delayed Egress Exit Device - Yale
- QC8 Power Transfer Hinge by McKinney®
- BPS Power Supply
- Surface Door Closer - Yale

Operation

Operation of the 7100D Exit Device will sound an alarm and activate either a 15- or 30-second alarm sequence inside of the exit device. After this time period, the device will release the pushpad, making it active and egress is possible. When the fire alarm is activated, power to the exit device will be interrupted, allowing free egress and mechanical latching. Authorized alarm bypass and reset is done through the built-in keyswitch located in the exit device.



Lever Trims

SquareBolt® 7150(F) 7250 7250M(F) Inside Outside		Rim 7100(F) 7200 7200M(F) Inside Outside		Surface Vertical Rod 7110(F) 7170(F) 7210 7210M(F) Inside Outside		Concealed Vertical Rod 7120(F) 7160(F) 7220 7220M(F) Inside Outside		Mortise 7130(F)	Type	ANSI Function No.	Function Description
					Exit Only/ Blank Plate	01 -	Exit only, no trim. Exit only, blank plate.				
					Dummy	02	Entrance by trim when actuating bar is locked down.				
					Nightlatch	03	Entrance by trim when latchbolt is retracted by key. Key removable only when locked.				
					Classroom	08	Entrance by lever. Key locks or unlocks lever.				
					Storeroom	09	Entrance by lever only when released by key. Key removable only when locked.				
					Passage	14	Entrance by trim when latchbolt is released by lever. Lever always active, no cylinder.				

Note: 09 and Free-Wheeling 02 achieved with a single modification at installation.

Double Cylinder Exit Device Lever Trims

SquareBolt® 7150(F)-2 Inside Outside		Rim 7100(F)-2 Inside Outside		Mortise 7130(F)-2 Inside Outside		Type	ANSI Function No.	Function Description
			Classroom	08	Entrance by lever. Key either side locks or unlocks lever.			

Functions



SquareBolt® 7150(F) 7250 7250M(F) Inside Outside		Rim 7100(F) 7200 7200M(F) Inside Outside		Surface Vertical Rod 7110(F) 7170(F) 7210 7210M(F) Inside Outside		Concealed Vertical Rod 7120(F) 7160(F) 7220 7220M(F) Inside Outside		Mortise 7130(F)	Type	ANSI Function No.	Function Description
									Exit Only/ Blank Plate	01 -	Exit only, no trim. Exit only, blank plate.
									Dummy/ Pull Plate	02	Entrance by trim when actuating bar is locked down.
									Nightlatch	03	Entrance by trim when latchbolt is retracted by key. Key removable only when locked.
									Classroom	05	Entrance by thumbpiece. Key locks or unlocks thumbpiece.
									Storeroom	06	Entrance by thumbpiece only when released by key. Key removable only when locked.
									Passage	15	Entrance by trim when latch is released by thumbpiece. Thumbpiece is always active, no cylinder.
									Classroom	11	Entrance by control turn piece. Key locks or unlocks control.
									Storeroom	12	Entrance by control turn piece only when released by turning key. Key removable only when locked.



7100 Series

The 7100 is the perfect choice for wide stile panic and fire-rated applications. The smooth architectural lines provide pleasing aesthetics to accent a building's appearance, and looks aren't always deceiving. Beneath the strong exterior lie the components to meet the demanding security and access control needs of today. The delayed egress option is just one of the many electromechanical options offered to enhance security. Complementing the 7100 series with the 600F series heavy-duty trim completes the package for a heavy-duty, security hardware package.

Applications

Single Door	UL Listing	Maximum Opening	Application		
SquareBolt*					
7150/7150-2	Panic	4' x *	Surface applied; single-point latching.		
7150F/7150F-2	3 Hr.	4' x 8'			
7150WS	Panic	4' x 8'	Surface applied; single-point latching. Used as components in swinging door windstorm-rated assemblies (refer to local codes).		
7150FWS	3 Hr.	4' x 8'			
Rim					
7100/7100-2	Panic	4' x *	Surface applied; single-point latching.		
7100F/7100F-2	3 Hr.	4' x 8'			
Mortise					
7130/7130-2	Panic	4' x *	Mortised in door; single-point latching.		
7130F/7130F-2	1-1/2 Hr.	4' x 9'			
7130F/7130F-2	3 Hr.	4' x 8'			
Surface Vertical Rod					
7110	Panic	4' x 8'	Surface applied; two-point latching.		
7170	Panic	4' x 10'			
7170 x LBR	Panic	4' x 10'	Surface applied; one-point latching.		
7170WS	Panic	4' x 8'	Surface applied; two-point latching. Used as components in swinging door windstorm-rated assemblies (refer to local codes).		
Concealed Vertical Rod					
7120	Panic	4' x 8'	Rods concealed in door; two-point latching.		
7160	Panic	4' x 10'			
7160 x LBR	Panic	4' x 10'		Rods concealed in door; one-point latching.	

*UL does not set a door height limitation on panic applications.

Pair of Doors with Removable Mullion	UL Listing	Maximum Opening	Application	
SquareBolt* x SquareBolt*				
7150 x 7150 x M200 Series	Panic	8' x 10'	Two independent active doors with removable mullion.	
7150F x 7150F x M200F Series	3 Hr.	8' x 8'		
7150WS x 7150WS x M200FWS	Panic	8' x 8'	Two independent active doors with removable mullion. Used as components in swinging door windstorm-rated assemblies (refer to local codes).	
7150FWS x 7150FWS x M200FWS	3 Hr.	8' x 8'		
Rim x Rim				
7100 x 7100 x M200 Series	Panic	8' x 10'	Two independent active doors with removable mullion.	
7100F x 7100F x M200F Series	3 Hr.	8' x 8'		

Applications





Pair of Doors	UL Listing	Maximum Opening	Application	
Surface Vertical Rod				
7110 x 7110	Panic	8' x 8'	Two independent doors with two-point latching, swinging in the same direction.	
7110F x 7110F	3 Hr.	8' x 8'		
7170 x 7170	Panic	8' x 10'	Two independent doors with one- or two-point latching, swinging in the same direction.	
7170F90 x 7170F90	1-1/2 Hr.	8' x 10'		
7170F x 7170F	3 Hr.	8' x 8'	Two independent doors with two-point latching, swinging in opposite directions. Used as components in swinging door windstorm-rated assemblies (refer to local codes).	
7170WS x 7170WS	Panic	8' x 8'		
7170FWS x 7170FWS	1-1/2 Hr.	8' x 8'		
Surface Vertical Rod (Double Egress)				
7110 x 7110	Panic	8' x 8'	Two independent doors with two-point latching, swinging in opposite directions. Overlapping astragal required for 3-hour openings.	
7110F x 7110F	3 Hr.	8' x 8'		
7170 x 7170	Panic	8' x 10'	Two independent doors with one- or two-point latching, swinging in opposite directions. Overlapping astragal not required.	
7170F90 x 7170F90	1-1/2 Hr.	8' x 10'		
7170F x 7170F	3 Hr.	8' x 8'		
Surface Vertical Rod x Mortise				
7110 x 7130	Panic	8' x 8'	Overlapping astragal required for 3-hour openings. Coordinator required with standard ANSI strike.	
7110F x 7130F	3 Hr.	8' x 8'		
7110F x 7130F x Open Back Strike	1-1/2 Hr.	8' x 8'	Overlapping astragal required for fire-rated openings. Coordinator required with standard ANSI strike.	
7170 x 7130	Panic	8' x 10'		
7170F90 x 7130F	1-1/2 Hr.	8' x 9'		
Concealed Vertical Rod				
7120 x 7120	Panic	8' x 8'	Two independent metal doors with two-point latching, swinging in the same direction.	
7120F x 7120F	3 Hr.	8' x 8'		
7160 x 7160	Panic	8' x 10'	Two independent metal or wood doors with one- or two-point latching, swinging in the same direction.	
7160F90 x 7160F90	1-1/2 Hr.	8' x 10'		
7160F x 7160F	3 Hr.	8' x 8'		
Concealed Vertical Rod (Double Egress)				
7120 x 7120	Panic	8' x 8'	Two independent metal doors with two-point latching, swinging in opposite directions. Overlapping astragal required for 3-hour openings.	
7120F x 7120F	3 Hr.	8' x 8'		
7160 x 7160	Panic	8' x 10'	Two independent metal or wood doors with one- or two-point latching, swinging in opposite directions. Overlapping astragal not required.	
7160F90 x 7160F90	1-1/2 Hr.	8' x 10'		
7160F x 7160F	3 Hr.	8' x 8'		



7200 Series

7200 Series narrow stile exit devices are designed for aluminum openings and are compatible with the aesthetics and functional requirements of contemporary glass doors. The device features lines chosen by leading architects and is available with the proven SquareBolt® exit device for increased security.

Applications

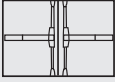
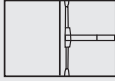
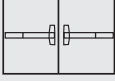
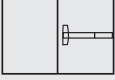
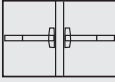
Single Door	UL Listing	Maximum Opening	Application	
SquareBolt®				
7250	Panic	4' x *	Surface applied; single-point latching.	
Rim				
7200	Panic	4' x *	Surface applied; single-point latching.	
Surface Vertical Rod				
7210	Panic	4' x 10'	Surface applied; two-point latching.	
Concealed Vertical Rod				
7220	Panic	4' x 10'	Rods concealed in door; two-point latching.	
Pair of Doors	UL Listing	Maximum Opening	Application	
Surface Vertical Rod				
7210 x 7210	Panic	8' x 10'	Two independent doors with two-point latching, swinging in the same direction.	
Surface Vertical Rod (Double Egress)				
7210 x 7210	Panic	8' x 10'	Two independent doors with two-point latching, swinging in opposite directions.	
Concealed Vertical Rod				
7220 x 7220	Panic	8' x 10'	Two independent metal doors with two-point latching, swinging in the same direction.	
Concealed Vertical Rod (Double Egress)				
7220 x 7220	Panic	8' x 10'	Two independent metal doors with two-point latching, swinging in opposite directions.	
Pair of Doors with Removable Mullion	UL Listing	Maximum Opening	Application	
SquareBolt® x SquareBolt®				
7250 x 7250 x M300	Panic	8' x 10'	Two independent active doors with removable mullion.	
Rim x Rim				
7200 x 7200 x M300	Panic	8' x 10'	Two independent active doors with removable mullion.	

Applications

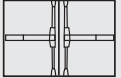
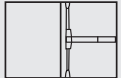
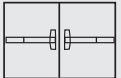
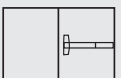

Pair of Doors	UL Listing	Maximum Opening	Application	
Surface Vertical Rod				
7210M x 7210M	Panic	8' x 10'	Two independent doors with two-point latching, swinging in the same direction.	
7210MF x 7210MF	3 Hr.	8' x 8'		
Surface Vertical Rod (Double Egress)				
7210M x 7210M	Panic	8' x 10'	Two independent doors with two-point latching, swinging in opposite directions.	
7210MF x 7210MF	3 Hr.	8' x 8'		
Concealed Vertical Rod				
7220M x 7220M	Panic	8' x 10'	Two independent metal doors with two-point latching, swinging in the same direction.	
7220MF x 7220MF	3 Hr.	8' x 8'		
Concealed Vertical Rod (Double Egress)				
7220M x 7220M	Panic	8' x 10'	Two independent metal doors with two-point latching, swinging in opposite directions.	
7220MF x 7220MF	3 Hr.	8' x 8'		

*UL does not set a door height limitation on panic applications.



7200M Series

The 7200M series combines the appearance of the 7200 narrow stile series with the life safety and fire rating options of the 7100 series. This unique narrow design exit device may be used on wide or flush stile doors and is available with a wide range of mechanical and electromechanical options including, electric latch pullback and monitoring features. The 7200M series is not to be used on narrow stile applications.

Applications

Single Door	UL Listing	Maximum Opening	Application	
SquareBolt®				
7250M	Panic	4' x *	Surface applied; single-point latching.	
7250MF	3 Hr.	4' x 8'		
7250MWS	Panic	4' x 8'		
7250MFWS	3 Hr.	4' x 8'		
Rim				
7200M	Panic	4' x *	Surface applied; single-point latching.	
7200MF	3 Hr.	4' x 8'		
Surface Vertical Rod				
7210M	Panic	4' x 10'	Surface applied; one- or two-point latching.	
Concealed Vertical Rod				
7220M	Panic	4' x 10'	Rods concealed in door; one- or two-point latching.	

*UL does not set a door height limitation on panic applications.

Pair of Doors with Removable Mullion	UL Listing	Maximum Opening	Application	
SquareBolt® x SquareBolt®				
7250M x 7250M x M200	Panic	8' x 10'	Two independent active doors with removable mullion.	
7250MF x 7250MF x M200F	3 Hr.	8' x 8'		
7250MWS x 7250MWS x M200FWS	Panic	8' x 8'		
7250MFWS x 7250MFWS x M200FWS	3 Hr.	8' x 8'		
Rim x Rim				
7200M x 7200M x M200	Panic	8' x 10'	Two independent active doors with removable mullion.	
7200MF x 7200MF x M200F	3 Hr.	8' x 8'		

Cylinders



Rim

The following chart details rim cylinders for use with 480F, 500F, 510F, 620F, 680F, 630F, 121NL trims and outside of SDA16 door alarm:

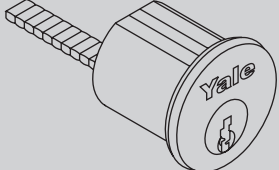
				Collar Requirements*					
				480F/500F/510F	620F/680F	630F	121NL	SDA16 Outside	
Model #	Description	Pins	Length						
1109	Standard Fixed Core	6	1-1/4"	599.419	No Collar	No Collar	1765.250	1765.250	
1109	Standard Fixed Core	7	1-7/16"			KP4			
1709	CMK	6	1-15/16"	599.544	1765.250	1765.250			
1709	CMK	7	1-5/8"			1765.406			
1193	LFIC Complete	6	1-7/16"	599.544	1765.344	1765.250			
1193	LFIC Complete	7	1-5/8"	599.700		1765.406			
5109	Security Fixed Core	6	1-9/16"	599.419	No Collar	1765.250			
5109	Security Fixed Core	7	1-7/16"						
U5109	High Security Fixed Core	6	1"	NA	No Collar	No Collar			No Collar
U5109	High Security Fixed Core	7	1"						
5193	Security LFIC Complete	6	1-7/16"	599.544	1765.250	1765.250	1765.250	1765.250	
5193	Security LFIC Complete	7	1-5/8"	599.700	1765.344	1765.406			
K300	Yale® KeyMark® Standard Fixed Core	6	1-1/8"	599.544	KP4	1765.250			
K300	Yale KeyMark Standard Fixed Core	7							
K840/K880	Yale KeyMark LFIC Complete / Housing Only	6	1-7/16"	599.700	1765.406	1765.500			
K840/K880	Yale KeyMark LFIC Complete / Housing Only	7	1-5/8"	NA	1765.563	1765.719			
K640/K680	Yale KeyMark SFIC Complete / Housing Only	6	1-1/4"	599.544	KP4	1765.250			
K640/K680	Yale KeyMark SFIC Complete / Housing Only	6 or 7	1-3/8"	599.700	1765.187	1765.406			
A640/K680	Best® Keyway SFIC Complete / Housing Only	6	1-1/4"	599.544	KP4	1765.250			
A640/K680	Best® Keyway SFIC Complete / Housing Only	6 or 7	1-3/8"	599.700	1765.187	1765.406			
2109	Schlage® "C" Keyway Fixed Core Available 0-bitted or keyed random.	6	1-1/8"	599.419	No Collar	No Collar			

*Based on 1-3/4" door thickness. Collar length required must be specified for cylinders and/or housings ordered separately.

LFIC = Large Format Interchangeable Core

SFIC = Small Format Interchangeable Core

NA = Application Not Available



Component

The following chart details component cylinders for use with 540F series trim.

Model #	Description	Pins
1802	Standard Lever Fixed Core	6
1802A	Standard Lever Fixed Core	7
5802A	Security Lever Fixed Core	7
1210	LFIC Only	6
1220	LFIC Only	7
5210	Security LFIC Only	6
5220	Security LFIC Only	7
K402	Yale KeyMark Lever Fixed Core	6 or 7
K800	Yale KeyMark LFIC Only	6 or 7
K600	Yale KeyMark SFIC Only	6 or 7
A600	Best® Keyway SFIC Only	6 or 7
2802	Schlage® "C" Keyway Fixed Core. Available 0-bitted or keyed random.	6
3804*	Corbin Russwin "L4", Corbin "60", Russwin "D1", Sargent® "LA" or Schlage® "E" Keyway Fixed Core. Specify keyway. Available keyed random	6

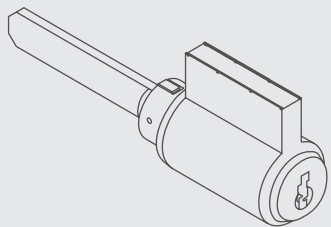

*Requires the 107S kit. These cylinders are not ANSI/BHMA certified.

121NL Cylinder Only

- Application: 7100(F) and 7150(F) rim and SquareBolt® exit devices. Not recommended for surface or concealed vertical rod devices.
- Must specify rim cylinder when ordering. See page 45 for cylinder options.
- Cylinder collar 1765.250 furnished standard for 1-3/4" thick doors.
- For 1109, 5109, K300, K640, A640 and 2109 cylinders:
 - Screw part number 34-2311-8738-048
 - Backplate part number 34-0010-1015-059
- For 1193, 5193 and K840 cylinders:
 - Screw part number 10-1193-1018-048
 - Backplate part number 34-0010-1015-059

Function Description	Nightlatch Access by Key
Model No.	121NL
ANSI	03

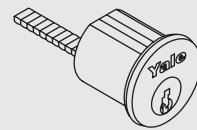

Cylinders



Mortise

The following chart details mortise cylinders for use with 350F, 650F, 660F, 670F trims, cylinder dogging, delayed egress, and 7116 alarms:

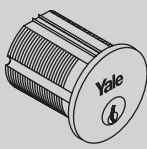
				350F/650F		660F/670F		Cylinder Dogging/ DEED/7116				
				Cam	Collar	Cam	Collar	Cam	Collar			
Model #	Description	Pins	Length	Cam	Collar	Cam	Collar	Cam	Collar			
2153	Standard Fixed Core	6	1-1/8	2160	NA	2160	NA	2160	No Collar			
		6	1-3/4		No Collar		KP4		NA			
		7	1-1/4		NA		NA		1765.156			
		7	1-3/4		No Collar		KP4		NA			
2196	LFIC Complete	6	1-1/2		NA		NA		1765.406			
		6	1-3/4		No Collar		KP4		NA			
2197	LFIC Complete	7	1-11/16		KP4		1765.250		1765.594			
5153	Security Fixed Core	6	1-1/8		NA		NA		No Collar			
		7	1-1/4		NA		NA		1765.156			
U5153	High Security Fixed Core	6	1-1/8		NA		NA		NA			
		7	1-1/4		NA		NA		NA			
5196	Security LFIC Complete	6	1-1/2		NA		NA		1765.406			
		6	1-3/4		No Collar		KP4		NA			
5197	Security LFIC Complete	7	1-11/16		KP4		1765.250		1765.594			
K100	Yale® KeyMark® Standard Fixed Core	6 or 7	1-1/8		KC1		NA		KC1	NA	KC1	No Collar
			1-3/4		No Collar		KP4		KC1	NA		
			1-3/4	Riveted	KP4	Riveted	1765.375	NA	NA			
K820/K860	Yale KeyMark LFIC Complete/Housing Only	6 or 7	1-3/4	KC1	No Collar	KC1	KP4	KC1	1765.406			
		7	1-11/16		KP4		1765.375		1765.594			
K620/K660	Yale KeyMark SFIC Complete/Housing Only	6	1-1/4		NA		NA		1765.156			
		6 or 7	1-3/8	No Collar	1765.281							
		6 or 7	1-3/4	Riveted	KP4	Riveted	1765.375	NA	NA			
A620/K660	Best Keyway SFIC Complete/Housing Only	6	1-1/4	KC1	NA	KC1	NA	KC1	1765.156			
		6 or 7	1-3/8	No Collar	1765.281							
		6 or 7	1-3/4	Riveted	KP4	Riveted	1765.375	NA	NA			
2553	Schlage® "C" Keyway Fixed Core. Available 0-bitted or keyed random.	6	1-1/8	2160	NA	2160	NA	2160	No Collar			

Cylinders



Mortise

The following chart details mortise cylinders for use with inside of SDA16 door alarm, KRM200 standard and windstorm mullions

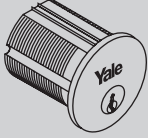
				SDA16 Inside		KRM200 (Standard)		KRM200 (Windstorm) Hurricane	
				Cam	Collar	Cam	Collar	Cam	Collar
Model #	Description	Pins	Length	Cam	Collar	Cam	Collar	Cam	Collar
2153	Standard Fixed Core	6	1-1/8"	2160	No Collar	2160	1765.312	2160	1765.156
2153	Standard Fixed Core	7	1-1/4"		No Collar		1765.500		1765.250
2196	LFIC Complete	6	1-1/2"		KP4		1765.750		1765.500
2197	LFIC Complete	7	1-11/16"		1765.250		1765.844		1765.719
5153	Security Fixed Core	6	1-1/8"		No Collar		1765.312		1765.156
5153	Security Fixed Core	7	1-1/4"		No Collar		1765.500		1765.250
U5153	High Security Fixed Core	6	NA		NA		NA		NA
U5153	High Security Fixed Core	7	NA		NA		NA		NA
5196	Security LFIC Complete	6	1-1/2"		KP4		1765.750		1765.500
5197	Security LFIC Complete	7	1-11/16"		1765.250		1765.844		1765.719
K100	Yale® KeyMark® Standard Fixed Core	6 or 7	1-1/8"		KC1		No Collar		KC1
K820/ K860	Yale KeyMark LFIC Complete / Housing Only	6	1-1/2"	KP4		1765.750	1765.500		
K820/ K860	Yale KeyMark LFIC Complete / Housing Only	7	1-11/16"	1765.250		1765.844	1765.719		
K620/ K660	Yale KeyMark SFIC Complete / Housing Only	6	1-1/4"	No Collar		1765.500	1765.250		
K620/ K660	Yale KeyMark SFIC Complete / Housing Only	6 or 7	1-3/8"	No Collar		1765.563	1765.500		
A620/ K660	Best® Keyway SFIC Complete / Housing Only	6	1-1/4"	No Collar		1765.500	1765.250		
A620/ K660	Best® Keyway SFIC Complete / Housing Only	6 or 7	1-3/8"	No Collar		1765.563	1765.500		
2553	Schlage® "C" Keyway Fixed Core. Available 0-bitted or keyed random.	6	1-1/8"	2160		No Collar	2160	1765.312	

Based on 1-3/4" door thickness. Collar length required must be specified for cylinders and/or housings ordered separately.

LFIC = Large Format Interchangeable Core.

SFIC = Small Format Interchangeable Core.

NA = Application Not Available



Collars & Tailpieces

Cylinder Collars

If required, cylinder collar size must be specified.

<p>1765 Recessed Cylinder Collar "A" Dimension: Thicknesses from 1/16" (2mm) to 1-15/32" (37mm) as required. Material: Brass, Bronze</p>	<p>KP3 Wave Washer (Furnished standard with 1765 collar for Yale® KeyMark® cylinders and 630F series trim).</p>	<p>599 Recessed Cylinder Collar with Radius "A" Dimension: Thicknesses from 1/16" (2mm) to 1-15/32" (37mm) as required. Material: Brass, Bronze</p>	<p>KP4 Flush Mount Cylinder Collar Material: Brass, Bronze</p>

Long Tailpiece Kit

Long tailpiece kit for use with escutcheon series trim, up to 4-1/2" thick doors.

Door Thickness	Trim Type	Part Number
2" - 2-1/2"	620F and 630F Series Trim	81-9500-1665-000
2-1/2" - 3-1/2"	620F and 630F Series Trim	81-9500-1635-000
3-1/2" - 4-1/2"	620F and 630F Series Trim	81-9500-1636-000

Specify part number to order.

Von Duprin® Tailpiece

This tailpiece is available for the Yale® 1109 rim cylinder to operate the night latch function for Von Duprin exit devices. To order, specify model number: 1145VD.



Strikes



Rim Devices

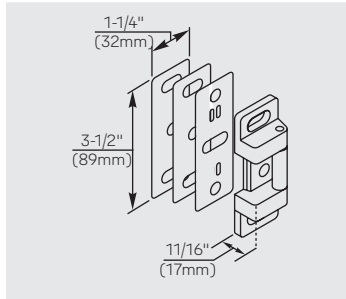

757F
Standard strike for 7100(F), 7150(F), 7200M(F) and 7250M(F) devices. Supplied with #10-24 x 3/4" machine screws, two shims (each 1/16" thick), and one locking plate.

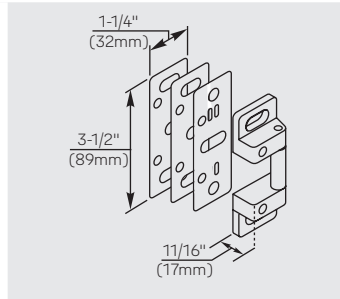

757FWS
Standard strike for 7150(F)WS and 7250M(F)WS devices. Supplied with 2 each #10-24 x 1-1/4" and 2 each #10-24 x 3/4" machine screws, two shims (each 1/16" thick), one locking plate and one interlocking bracket (not shown) with 4 each #10-24 x 3/4" machine screws.

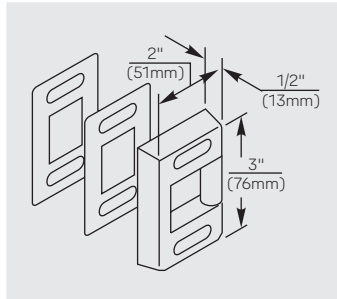

759
Standard strike for 7200, 7205 devices.

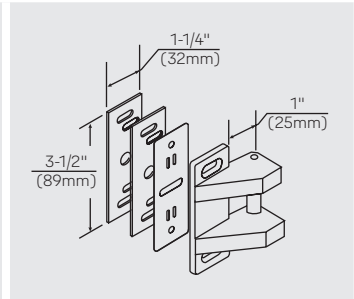

793
Optional strike for double door applications without a mullion. Supplied with #10-24 x 3/4" machine screws, two shims (each 1/16" thick), and one locking plate. Panic only.

Vertical Rod Devices - Top Strikes

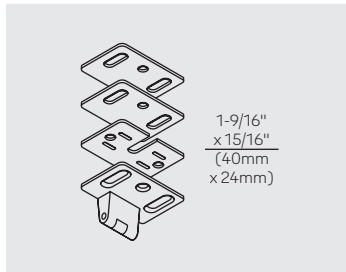

791
Standard top strike for 7110(F), 7120(F), 7210, 7220, 7210M(F), 7220M(F) series devices. Supplied with #10-24 x 3/4" machine screws, two shims (each 1/16" thick), and one locking plate.

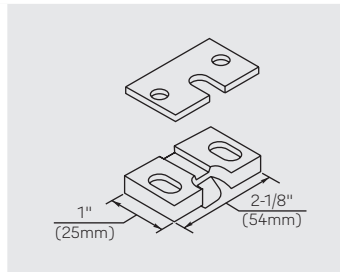

726
Standard top strike for 7170(F) series devices. Supplied with #12-24 x 11/16" machine screws and #12 x 1-1/4" sheet metal screws, and one shim (1/16" thick).

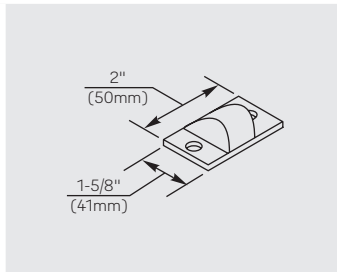

761
Standard top strike for 7160(F) series devices. Supplied with #10-32 x 3/8" machine screws and #10 x 1" sheet metal screws.

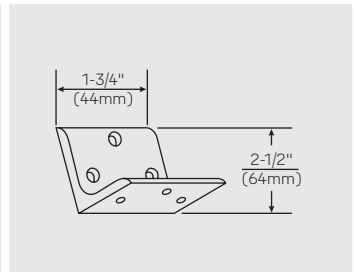

797
Optional bracket for mounting 791 top strike in flush transom opening. Supplied with 1/4-20 machine screws; SN-134 sex nuts, optional.

Vertical Rod Devices - Bottom Strikes

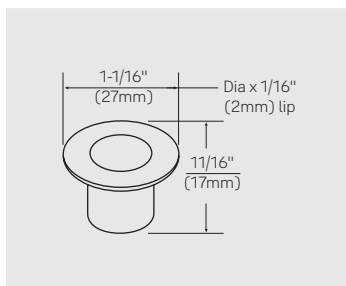

790
Standard bottom strike for 7110(F), 7120(F), 7160(F), 7170(F), 7210, 7220, 7210M(F), 7220M(F) series devices. Press in place.

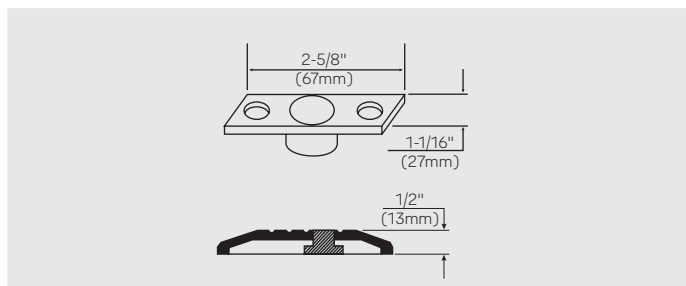

794
Optional bottom strike for fire openings using saddle thresholds or for flush floor mount. Must use for fire openings with 1/2" thresholds. Supplied with #10-24 x 1/2" machine screws and floor anchors.

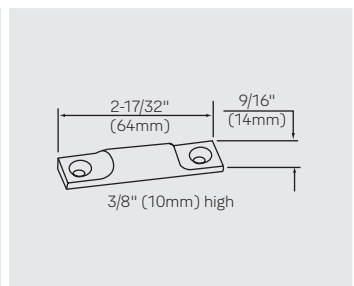

702
Optional bottom strike for bottom pullman latch option. Supplied with #8 x 8/32" combination screws.

Strikes



Mortise Devices

<p>798 Standard curved lip ANSI strike used with 7130(F) devices. (1-1/4" lip)</p>	<p>712 Optional flat lip ANSI strike used with 7130 devices for pairs of doors with astragals. (7/8" lip)</p>	<p>718 Optional open back strike. Permits opening of the inactive door for pairs of doors where approved by door manufacturer.</p>	<p>202 Optional strike box for ANSI strikes. 7/8" (22mm) deep.</p>



Shim Kits

Shim kits, for devices on doors with interfering molding, are available. Each standard shim kit contains 2 sets of 1/8" thick shims to shim a device 1/8" (3mm) or 1/4" (6mm). Windstorm (WS) shim kits contain 3 sets of 1/8" thick shims. Longer device mounting screws (not included) are required for more than 1/4" (6mm) shimming. 693 (Black) finish.

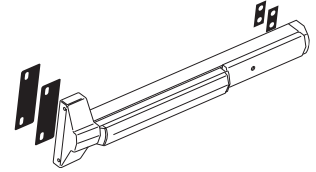

723	Shim kit for 7100(F) series rim, 7150(F) series SquareBolt®, 7120(F), 7160(F) series* concealed vertical rod, and 7130(F) series* mortise exit devices.
723WS	Shim kit for 7150(F)WS series SquareBolt exit devices.
723NS	Shim kit for 7200 series rim, 7200M(F) series rim, 7250 series SquareBolt, 7250M(F) series SquareBolt, 7220 series* and 7220M(F)* concealed vertical rod exit devices.
723NSWS	Shim kit for 7250M(F)WS series SquareBolt exit devices.
724	Shim kit for 7110(F) and 7170(F) series surface vertical rod exit devices.
724WS	Shim kit for 7170(F)WS series surface vertical rod exit devices.
724NS	Shim kit for 7210(F) series surface vertical rod exit devices.

*Note: Special mortise or concealed vertical rod components needed for openings requiring more than (2) shim kits, or for shimmed mortise devices in doors over 1-3/4" (44mm) thick. Details on application.

Extension Rods

Model #	Length
7010-2	2" (51mm)
7010-6	6" (152mm)
7010-12	12" (305mm)
7010-24	24" (610mm)

Specify finish.

Specialty Fasteners

Sex Nuts:

Required for wood, composite or unreinforced metal doors.

- **SN-104** – Interlock bracket pack of (4) 10-24 sex nuts for all fire rim and SquareBolt® devices.
- **SN-134** – pack of (4) 1/4-20 sex nuts for all devices.

TORX® Security Screws:

Available for factory product orders. Wood screws may only be used in predrilled pilot holes of solid core wood doors.

Accessories/Options



720 Dummy Pushbar

For push-pull vestibule doors leading to doors with 7000 series exit devices. Bars fit doors up to 48" (122cm) wide. Same finishes as devices. Specify 720 x finish.

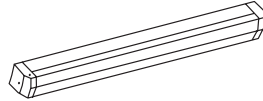

730 Touchpad Cover

Field replacement cover to renew touchpad looks. Specify 730-36 or 730-48 x finish.

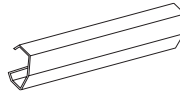

Lumi-Lite Touchpad Cover

The Lumi-lite touchpad cover can be ordered separately and easily retrofits to existing 7000 exit devices in the field. To order specify: 730-36LUM for 36" cover and 730-48LUM for 48" cover

Flush End Cap

The flush end cap is a heavy-duty flush mounted end cap constructed of solid cast or stainless steel materials. For use on exit devices subject to abuse by vehicles being pushed through the doorway opening; i.e. carts, gurneys, wagons, etc. To order with device, specify option: ECK1. Available as a retrofit kit for existing installations, to order specify part number: 81-9500-0620 x finish.



Bottom Pullman Latch

Optional bottom pullman latch available for panic listed vertical rod exit devices. To order with devices, specify "BPL." 702 bottom strike required, see page 49.



Cylinder Dogging

Cylinder dogging is available for all panic-listed exit devices only. Requires use of 1-1/8" mortise cylinder. When ordered with a devices, cylinder must be ordered separately. (See How to Order, "Fourth Digit", page 5.) Cylinder dogging kit available; specify 715-48 (cylinder not included with this kit).

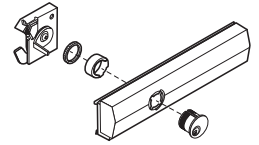

Replacement End Cap

The 7000 series replacement end cap is designed with heavy-duty material with three screw holes in strategic locations to resist abuse and maintain functionality. The ECK7 kit is available for easy retrofit to existing exit devices. To order retrofit kit, specify ECK7 x finish.



Reinforced End Cap**

This end cap consists of a solid steel plate welded to the end bracket which evenly distributes impact forces over a larger surface area, thus eliminating point loading. To order with device, specify option ECK3. To order separately, specify kit model number ECK3. Kit includes reinforced bracket, end cap and (6) 1/4" x 20 screws.

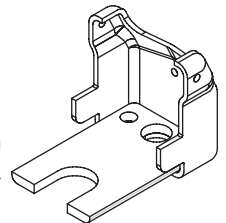

**Note: Six 1/4 x 20 screws come standard with either ECK3 option or kit. Only two screws required to fasten end cap assembly to door for retrofit. Other four screws are used with SquareBolt® Latch Head if ordered as an ECK3 option with complete device. When the kit is ordered a new end cap is also supplied, finish must be specified.



Anti-Pry Bracket

The anti-pry bracket offers end users increased security by improving resistance against jamb spreading during a pry attack. When the door is in the closed position, the anti-pry bracket interlocks in position between the exit device strike and frame preventing the strike and exit device latch from being separated. For use with all 7100(F) rim and 7150(F) SquareBolt® devices. Kit includes interlock bracket and end cap shim, the standard exit device mounting screws can be used, therefore, no additional fasteners are required. Black powder coat finish. To order specify option/model number: 725



Less Bottom Rod

7170(F90) surface and 7160(F90) concealed vertical rod exit devices available less bottom rod. Fire-rated devices supplied standard with a heat-activated door bolt popper. To order, suffix LBR.

Plastic Installation Template

Provided as a standard with all 7000 series exit device, the plastic installation template facilitates door markings over traditional paper templates. This provides a more accurate door prep which reduces installation mistakes and overall installation time. Template dimensions: 8-1/4" x 3-1/4" (210mm x 83mm). To order separately, specify part number: 60-7000-9100-999.

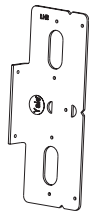

Schlage® Cam Assembly

This cam and housing assembly includes a cam engineered to accept Schlage rim cylinders. No modifications are required to existing 500 and 600 series exit device trims thus maintaining the trim's classroom and storeroom functions. To order, specify part number: 60-7000-0815.





Mullions

M200(F) Removable Mullion

M200(F) steel mullions are for use with 7100(F) series exit devices. Mullions may be field cut to fit opening. Red primer finish.

- M200 panic rated.
Tubular steel, 2" x 3" (51mm x 76mm). Specify 7', 8', or 10'.
- M200F 3 hour fire rated.
Tubular steel, 2" x 3" (51mm x 76mm). Specify 7' or 8'.
- M200FWS 3 hour fire rated.
Certified hurricane resistant (refer to local codes).  Hurricane
Tubular steel, 2" x 3" (51mm x 76mm). Specify 7' or 8'.

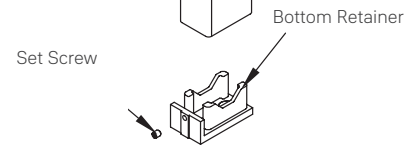
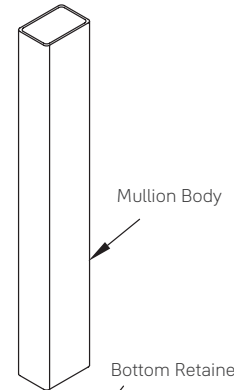
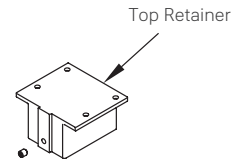

M200(F)

M300 Removable Mullion

M300 mullions are for use with 7200 series exit devices. They consist of an aluminum extrusion 1-1/4" x 3" (32mm x 76mm), with built-in strikes for device bolts. Supplied with mounting brackets, mechanical fasteners, and mullion stabilizers. Available finishes are 628 (Satin, clear anodized) and 695 (dark amber coat). Specify 8' or 10'. For 9' mullion, specify 10' and cut to size in field.

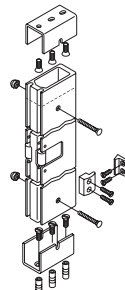

M300

102S Mullion Stabilizer Kit

Recommended for high openings and whenever door movement must be further restricted. Supplied standard with M300 mullions. To order separately, specify 102S.

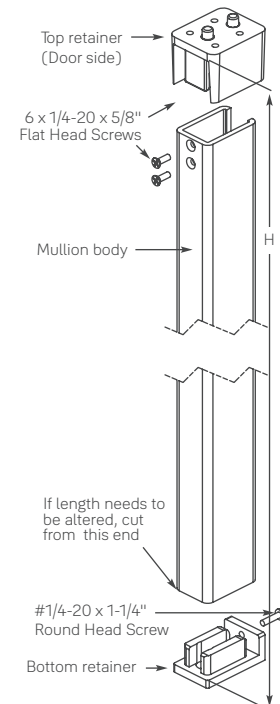

M200FWS

Mullions



KRM200(F) Keyed Removable Mullion (KRM)

Keyed removable mullions are for use with 7100(F) series exit devices. They are designed for simple removing when an unobstructed large opening is required and easy replacement and locking to maintain the integrity of the opening.

- Easy cylinder installation.
- Mullion automatically relocks when reinstalled without the use of the cylinder key.
- When ordering, add KR prefix to mullion, example: KRM200 and KRM200F.
- KRM200 panic rated. Specify 7', 8', or 10'.
- KRM200F 1-1/2 hour fire rated. Specify 7' or 8'.
- KRM200FWS 3 hour fire rated.
Certified hurricane resistant (refer to local codes). Specify 7' or 8'.  Hurricane

M200(F) And KRM Options

• M203 Spacer Block

Recommended for double rabbeted frames where the stop face width is less than the mounting hole spacing or for applications with 5-3/4" (146mm) or less door frames.

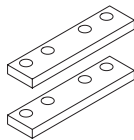

• M204 Angle Bracket

Recommended for any header configuration with less than 3" (76mm) of mounting surface.

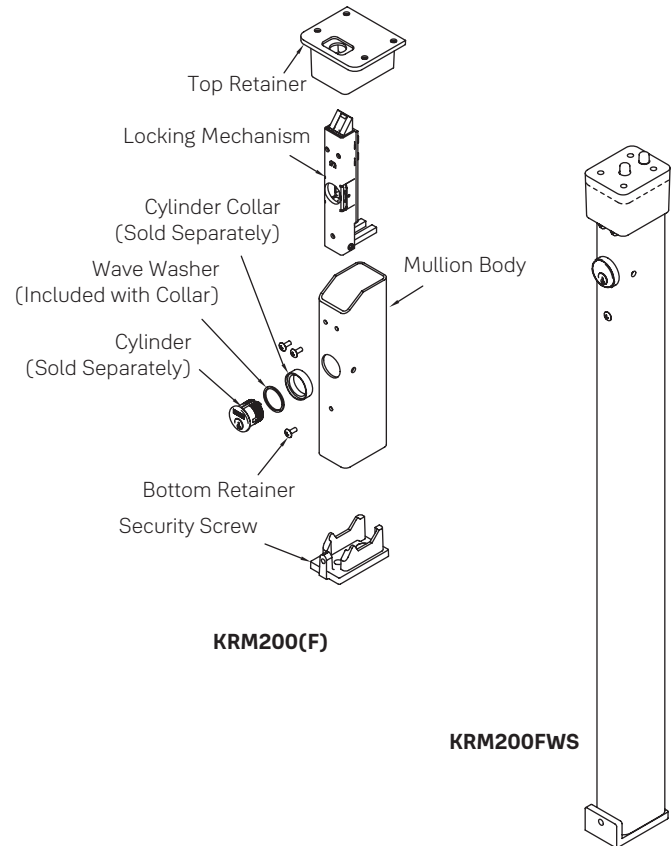
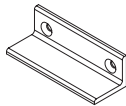

KRM Cylinders

As with any exit device trim, you must order a cylinder and collar if one is required. The Yale® keyed removable mullion accepts a mortise cylinder. Refer to page 52 for details.



Dimensions

Device

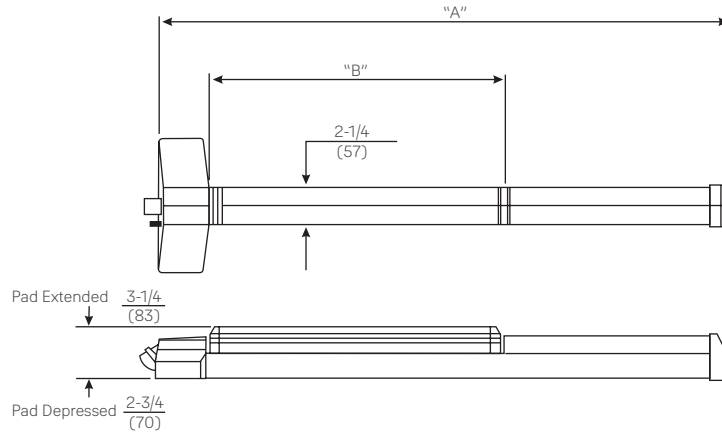
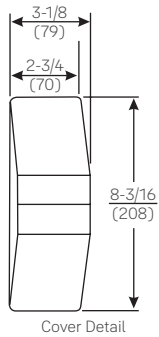

7100 Series
(all variables)

Series	"A"	"B"
7100-36	32-7/8" (835mm)	18" (457mm)
7100F-36		
7100-48	44-7/8" (1130mm)	24" (610mm)
7100F-48		

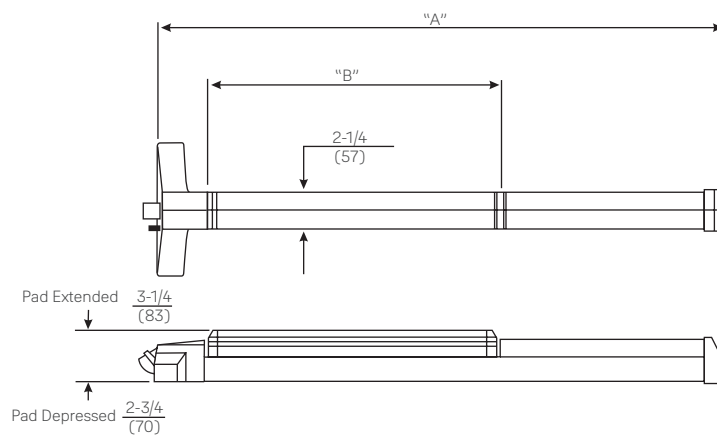
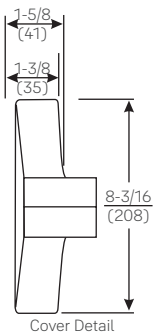

7200 and 7200M Series
(all variables)

Series	"A"	"B"
7200-36	34-5/8" (880mm)	18" (457mm)
7200M-36	32-7/8" (835mm)	18" (457mm)
7200MF-36		
7200-48	46-5/8" (1184mm)	24" (610mm)
7200M-48	44-7/8" (1130mm)	24" (610mm)
7200MF-48		

Dimensions

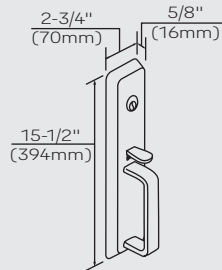
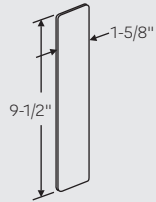
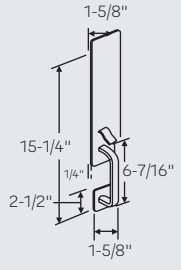
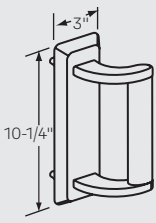
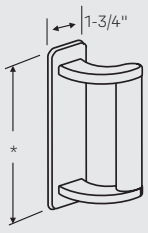

Trim Dimensions

620F/650F Series	630F/660F Series	500F Series
 <p>Projection: 13/16" (20mm)</p>	 <p>Projection: 2-3/4" (70mm)</p>	 <p>Projection: 1/4" (6mm)</p>
510F Series	680F Series	480F Series
 <p>Projection: 2-1/8" (54mm)</p>	 <p>Projection: 3" (76mm)</p>	 <p>Projection: 2-7/8" (73mm)</p>

*Length varies by pull, see page 26

Sample Specifications



Specification

Exit devices shall be 7000 Series Pushpad Exit Devices as manufactured by Yale Locks & Hardware.

The exit device chassis shall be cold forged steel, electroplated for corrosion resistance, and shall be architecturally finished brass, bronze or stainless steel. The pushpad mechanism shall be constructed of extruded aluminum and shall be scalped with architecturally finished brass, bronze or stainless steel. The maximum projection shall be 3-1/4" when the pushpad is active and 2-3/4" when the pushpad is dogged down. Nylon bearings and stainless steel springs shall be used for long life and durability; only torsion springs are acceptable. Rear and active case covers shall be wrought brass or bronze and shall be plated to match the exit bar. Plastic or painted covers are not acceptable. Latchbolts shall be steel and shall incorporate a deadlocking latch for increased security. Devices without deadlocking latches are not acceptable. Mounting screws shall be concealed to deter tampering. Devices shall be closed on all sides with no pinch points. Exit devices shall be easily field sized to accommodate various door widths.

Panic-listed exit devices shall have single point, one quarter turn hex key dogging standard. Optional cylinder dogging shall be available on panic listed devices. Devices with hex key dogging shall be easily field converted to cylinder dogging. Panic listed devices shall be available less dogging.

Trims shall be throughbolted with concealed fasteners. Escutcheon and pull-type trims shall be constructed of brass or bronze. All lever trims shall use cast or forged levers. On rim, SquareBolt® and vertical rod trims with cylinders, the mechanism that locks and unlocks the trim shall be housed in the trim and not in the active case of the exit device. Lever trims (except mortise) shall be Free-Wheeling with clutch mechanism allowing lever to rotate 60° when locked for ideal protection. Lever trims shall match those on Yale® mortise and cylindrical locksets.

Exit devices and trims shall be furnished in ANSI/BHMA standard architectural finishes.

Exit devices shall be listed by Underwriters Laboratories (UL) for safety as panic hardware. Fire-rated devices shall be listed for A label and lesser class doors.

Certification:
ANSI/BHMA A156.3, Grade 1

Devices, trims and cylinders shall be from one manufacturer.

Devices and 600 Series trim shall carry a five-year limited warranty.

500 Series trim shall carry a one-year limited warranty.

Electronic components shall carry a two-year limited warranty.

Delayed Egress Specification

Delayed egress exit devices shall be 7100/7200 Series (rim, SquareBolt®, mortise or concealed vertical rod) with the "D" suffix, manufactured by Yale Locks & Hardware.

The delayed egress device secures the door in the locked mode. Depressing the pushpad for less than three seconds will sound the device siren without initiating the alarm. Depressing the pushpad longer than three seconds will initiate an irreversible local audible beeping tone and allow the device to release for egress after 15 seconds. The alarm will continue until reset by the mechanical key switch located on the device. (When acceptable by local code agency, the delay period may be increased to 30 seconds, or other approved amount of time. Consult factory.)

Devices shall be 24 volts DC.

The exit device chassis shall be cold forged steel, electroplated for corrosion resistance, and shall be architecturally finished brass, bronze or stainless steel. The pushpad mechanism shall be constructed of extruded aluminum and shall be scalped with architecturally finished brass, bronze or stainless steel. The maximum projection shall be 3-1/4" when the pushpad is active and 2-3/4" when the pushpad is depressed. Nylon bearings and steel springs shall be used for long life and durability. Active case and alarm end cover shall be wrought brass, bronze or stainless steel and shall be plated to match the exit bar. Painted or plastic covers or end caps are not acceptable. Latchbolts shall be steel and shall incorporate a deadlocking latch for increased security. Devices without deadlocking latches are not acceptable. Mounting screws shall be concealed to deter tampering. Devices shall be closed on all sides with no pinch points. Device active cover and end cap attaching screws shall be security TORX®. When required, door position switches used on rim or SquareBolt devices shall be incorporated into the latch assembly of the device to allow added security.

Trims shall be throughbolted with concealed fasteners. Escutcheon and pull-type trims shall be constructed of brass, bronze or stainless steel. All lever trims shall use cast or forged levers. On rim, SquareBolt and vertical rod trims with cylinders, the mechanism that locks and unlocks the trim shall be housed in the trim and not in the active head of the exit device. Lever trims shall match those on Yale mortise and cylindrical locksets. Lever trims (except mortise) must have a clutch or Free-Wheeling spring assembly when in the locked mode for ideal protection and reduced damage to the trim. Rigid lever trims are not acceptable.

Exit devices, trims and cylinders must be from one manufacturer.



Trusted every day

Phone

1-855-557-5078

Customer Service Email

customerservice.yale@assaabloy.com

Technical Product Support Email

techsupport.yale@assaabloy.com

Order Entry Email

orders.yaleus@assaabloy.com

Fax

1-800-338-0965

Website

www.yalecommercial.com

Contact Us

U.S.A.

Yale Locks & Hardware

Address: 225 Episcopal Road

Berlin, CT 06037-4004

Tel: 1-800-438-1951

Fax: 1-800-338-0965

yalecommercial.com

Canada:

ASSA ABLOY Door Security Solutions Canada

Address: 160 Four Valley Drive

Vaughan, Ontario L4K 4T9

Tel: 1-800-461-3007

Fax: 1-800-461-8989

assaabloydss.ca

International:

ASSA ABLOY Americas International

Tel: 1-905-821-7775

Fax: 1-905-821-1429

assaabloyai.com

MicroShield®

ASSA ABLOY Group companies offer MicroShield®, an anti-microbial coating for door hardware. MicroShield uses proven silver ion-based technology from Agion®, a leading provider of antimicrobial solutions, to stem the spread of bacteria and other microbes.

MicroShield® is a registered trademark of ASSA ABLOY Access and Egress Hardware Group, Inc.



The Agion antimicrobial is not intended as a substitute for good hygiene. Coated products must still be cleaned to ensure the surfaces will be free of destructive microbes. ASSA ABLOY makes no representations or warranties, express or implied, as to the efficacy of the Agion antimicrobial. A copy of the Agion warranty is available upon request. Agion is a registered trademark of Agion Technologies, Inc., Wakefield, MA, USA.

THE YALE BRAND, with its unparalleled global reach and range of products, reassures more people in more countries than any other consumer locking solution.

THE ASSA ABLOY GROUP is the world's leading manufacturer and supplier of locking solutions, dedicated to satisfying end-user needs for security, safety and convenience.

Yale Commercial is a business associated with ASSA ABLOY Access and Egress Hardware Group, Inc., an ASSA ABLOY Group company. Copyright © 2004-2021, ASSA ABLOY Access and Egress Hardware Group, Inc. All rights reserved. Reproduction in whole or in part without the express written permission of ASSA ABLOY Access and Egress Hardware Group, Inc. is prohibited. Patent pending and/or patent www.assaabloydss.com/patents.



6000 Series Commercial Exit Devices



Table of Contents









Introduction.....	3-4	Trim Designs.....	17-19
Benefits and Features.....	5	6100ED Series Wide Stile Trims.....	20-24
Finishes.....	6	6200ED Series Narrow Stile Trims.....	25
How To Order.....	7	Electrified Options.....	26-33
6100ED(F) Rim.....	8	Functions.....	34-35
6150ED(F) SquareBolt®.....	9	Applications & Listings.....	36-39
6170ED(F) Surface Vertical Rod.....	10	Cylinders.....	40-43
6160ED(F) Concealed Vertical Rod.....	11	Collars & Tailpieces.....	44
6130ED(F) Mortise.....	12	Strikes.....	45-46
6200ED Rim.....	13	Accessories and Options.....	47-48
6250ED SquareBolt®.....	14	Mullions.....	49-50
6210ED Surface Vertical Rod.....	15	Dimensions.....	51
6220ED Concealed Vertical Rod.....	16	Sample Specifications.....	52

Introduction

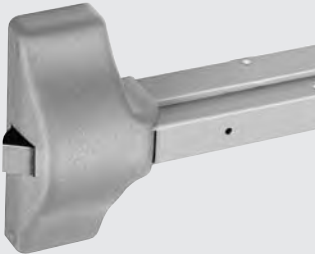

Yale® Commercial Solutions offers innovative and reliable products to solve the challenges of commercial, retail, hospitality, assisted living, mixed-use, and multi-family properties. With over 150 years of door hardware experience, Yale's expertise extends beyond products to people - and provides the service and support you expect.

Featuring durable products to meet all your facilities' requirements - and the quality you expect from a leader in the hardware industry. Yale works for youSM.

Yale Exit Devices			
7000 Series	2100 Series	1800 Series	1500 Series
			
			
<ul style="list-style-type: none"> • Ideal for facilities that require durability and innovation to meet their security needs • Wide & Narrow Stile Applications • Rim, SquareBolt, Mortise, SVR & CVR • Mechanical & Electro-Mechanical Functions • Available with Motorized Electric Latch Retraction • Constructed with high quality steel and heavy-duty components • 16 Standard finishes including BSP (Black Suede Powder Coat) • UL Rated for Panic & Fire • ANSI/BHMA Certified Grade 1 • 5 Year Warranty and Two-Year Limited Warranty on Electronic Components • UL Rated for Panic & Fire, Windstorm Rated Options (refer to local codes) 	<ul style="list-style-type: none"> • Ideal for commercial applications and budget conscious end users • Wide Stile Applications • Rim, Squarebolt, CVR & SVR • Mechanical Functions • ANSI/BHMA Grade 1 Certified • UL Rated for Panic & Fire • Architectural & Painted Finishes • 3 Year Warranty 	<ul style="list-style-type: none"> • Ideal for back of the house where function and code compliance are the requirement • Wide Stile Applications • Rim & SVR • Mechanical Functions • ANSI/BHMA Certified Grade 1 • UL Rated for Panic & Fire • Powder-coat Painted Finishes • 1 Year Warranty 	<ul style="list-style-type: none"> • Ideal for renovation projects where historical preservation is the desired look • Wide Stile Applications • Rim, CVR, SVR & Mortise • ANSI/BHMA Certified Grade 1 • UL Rated for Panic & Fire • Can Meet Buy American Act • Architectural & Painted Finishes • 1 Year Warranty

Introduction



With a full range of functions and options and ANSI Grade 1 certification, the Yale® 6000ED Series exit devices provide the right security for your commercial facility.

The stylish, clean lines of the wide and narrow stile 6000ED are visually appealing and blend with any decor. With a multitude of mechanical and electromechanical functions available, the 6000ED can be used in many types of facilities including office buildings, retail environments and mixed-use, and is perfect for both new construction and retrofit applications.

Yale 6000ED Series exit devices come with a full array of electromechanical options and accessories and can be effortlessly integrated into existing security or fire alarm systems.

6100ED(F) Series (Wide Stile)

The 6100ED(F) exit device series is available in rim, SquareBolt®, mortise, surface and concealed vertical rod configurations. Perfect for single swing doors or pairs of doors of metal, wood or composite construction. The 6100ED(F) Series is available in both panic and fire rated versions. See pages 8-12 for more information.



6200ED Series (Narrow Stile)

The 6200ED exit device series is available in rim, SquareBolt®, surface and concealed vertical rod configurations. Perfect for single swing doors or pairs of doors of metal or aluminum. The 6200ED series is panic rated. See pages 13-16 for more information.



Warranty

- Mechanical exit devices and 400F, 500F, and 600F trims carry a 10-year limited warranty.
- 690F and 691F trims carry a two-year limited warranty.
- Electrical options and components carry a two-year limited warranty.



Benefits & Features

Benefits

- **Smooth, Quiet Operation:** Unique design provides noise reduction and smooth operation of the touch bar
- **Stylish:** Attractive, modern design blends aluminum rail with architectural finishes; available with over 38 levers to match any decor
- **Strong and Reliable:** ANSI/BHMA Grade 1 certified for long life
- **Secure:** Multiple security features provide added resistance against vandalism and authorized entry

Features

- ANSI/BHMA A156.3 Grade 1 certified 
- Available as rim, mortise, SquareBolt®, surface vertical rod and concealed vertical rod in wide or narrow stile configurations
- Highly durable aluminum rail design with architecturally finished touch bar in 5 finishes
- Heavy duty, angled end cap design protects rail, eliminates catch points and reduces damage
- Available in 13 mechanical functions and 11 electromechanical functions
- Available with standard or Reflections® decorative levers
- Complete offering of mechanical and electro-mechanical solutions
- Available with Microshield® antimicrobial coating
- 10 year warranty

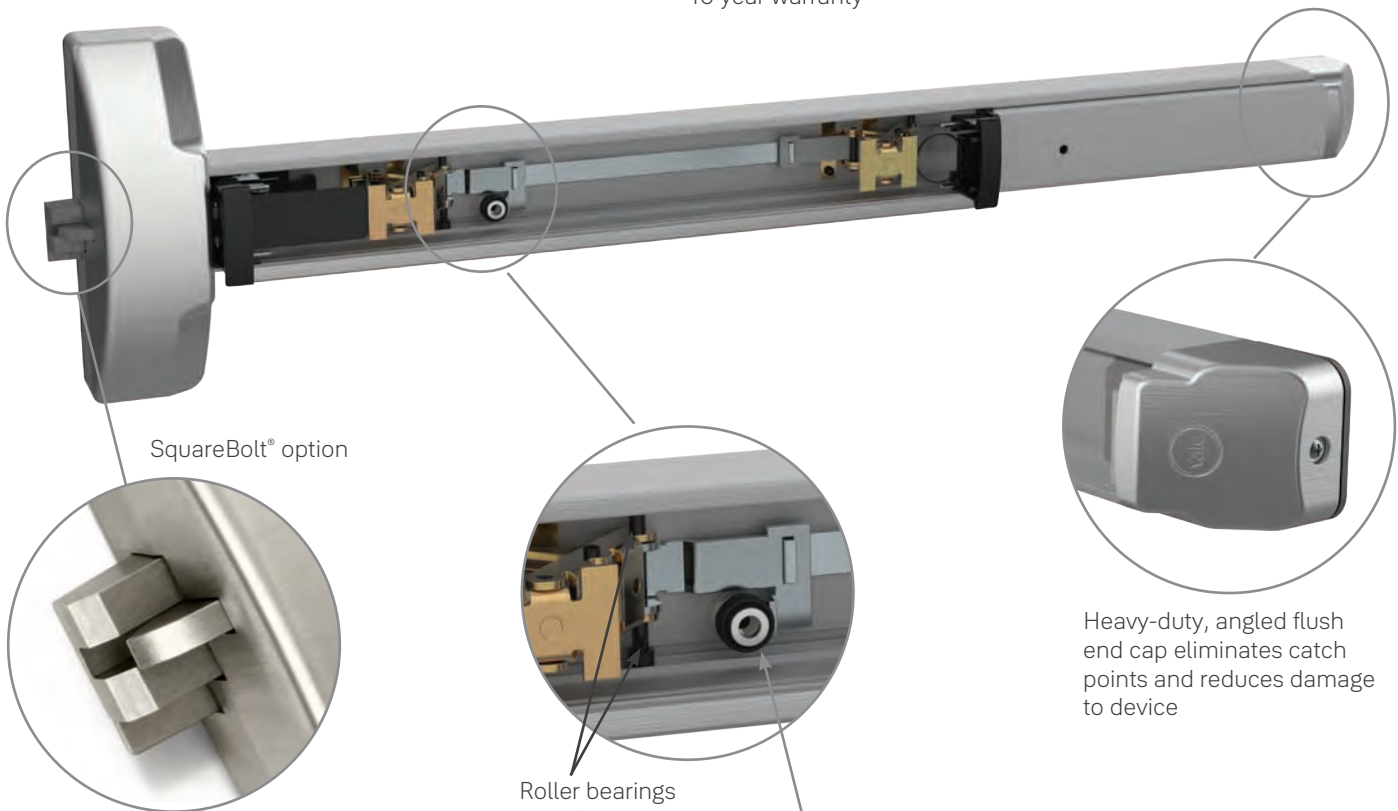

SquareBolt® option

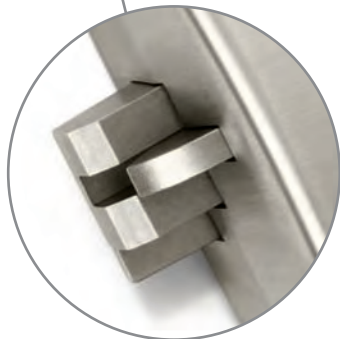

The SquareBolt option offers a latchbolt with greater latch engagement than standard rim devices. Credit cards, crowbars, door rattling and shaking are resisted, significantly reducing the threat of unauthorized entry



Roller bearings provide smooth operation of the touch bar



Heavy-duty, angled flush end cap eliminates catch points and reduces damage to device

Bumpers reduce noise when pad is pushed to exit

Finishes



ANSI/BHMA Code Finish Description			
605 Bright Brass, Clear Coated	606 Satin Brass, Clear Coated	613E Dark Oxidized Satin Bronze - equivalent	629 Bright Stainless Steel
630 Satin Stainless Steel	BSP Black Suede Powder Coat	WSP White Suede Powder Coat	

Trim Finishes

ANSI/BHMA Code Finish Description				
605 Bright Brass, Clear Coated	606 Satin Brass, Clear Coated	613E Dark Oxidized Satin Bronze - equivalent	625 Bright Chrome Plated	626* Satin Chrome Plated
629 Bright Stainless Steel	630* Satin Stainless Steel	BSP Black Suede Powder Coat	WSP White Suede Powder Coat	

Add YMS suffix to order Microshield® antimicrobial coating

*Finish available with MicroShield® antimicrobial coating, additional finishes by special application. Consult factory for availability.

MicroShield coating may vary finish color from architectural standards. MicroShield is not intended as a substitute for traditional infection control programs such as hand hygiene or use of disinfectants. Coated products must still be cleaned to ensure the surfaces will be free of destructive microbes. Yale makes no representations or warranties, express or implied, as to the efficacy of MicroShield.



How To Order

Using the chart below, construct the part number based on the options, trim and finish needed.

6	X	X	XED	Mechanical/Electrical	Size ⁵	Design	Trim	Finish	Other Info
	Second Digit: "1" -Standard device, 4-1/2" (114mm) or wider door stile. "2" -Narrow stile door or narrow escutcheon trim (500F, 510F Series)	Third Digit: "0" - Rim Device, Pullman Latch "1" - SVR Device (narrow stile) "2" - CVR Device (narrow stile) "3" - Mortise Device "5" - SquareBolt*, Rim Security "6" - CVR Device (wide stile) "7" - SVR Device (wide stile)	Fourth Digit: "0" - Standard "5" - Cylinder Dogging (Not with suffix "F")	Mechanical Feature "F" - Fire Exit Device "LBR"- Less Bottom Rod ² "L5" - Mortise Device, Entry by Key with/without Rigid Lever ¹ "L8" - Mortise Device, Entry by Lever "2" - Double Cylinder Device ³ Electrical Feature "A" - Alarm Kit "A-ALR" - Alarm Kit with red screenprinted touchpad "B" - Bar Monitor or Signaling "G" - Electric Dogging "O" - Outside Trim Monitor or Signaling "P" - Latch Pullback "S" - Latchbolt Status Monitor or Signaling "Safe" - Mortise Device Trim Control (Lever only) "Secure" - Mortise Device Trim Control (Lever only)	Size: DOW = Door Opening Width) "24" 24" DOW ⁴ "36" - 30" to 36" DOW 42" for 36"-42" DOW "48" - 42" to 48" DOW Door Height: -7 = 7' standard -8 = 8' (2.44m) -9 = 9' (2.74m) -10 = 10' (3.05m)	Trim Design See pages 17-18	Trim Model Number See pages 19-25	See Page 6	Other Information: Door Hand - RHR or LHR Door Thickness - Over 1-3/4" (45mm) Fastener Options - TORX® Security Screws SNB (wood, composite, or unreinforced metal doors) Specialty Cylinders & Components (see pages 37-40)

It is recommended that exit devices and trim for the same opening be ordered together. Standard product is for 1-3/4" (44mm) reinforced metal doors. Accessories detached from the device and trim should be specified separately. Materials by others are required to be fit for the purpose as detailed in this catalog and the product installation literature.

Notes:

1. Required for electrical feature, Suffix "-SAFE" or "-SECURE".
2. LBR available on 6160(F90) and 6170(F90) devices only.
3. For double cylinder devices, suffix "-2" after fourth digit.
4. If "-24" device is to be used with a DOW greater than 24", the device will ship without UL label. The 12" touchpad will not cover 50% of the device touchbar length.
5. Contact door manufacturer for detailed frame/door requirements and limitations.

Ordering Examples

Exit Device Only

6150EDD-36 x 626 x RHR x SNB

Exit Device with Trim and Cylinder*

6170EDF90-9-48 x AU626F x 605 x LHR x 1109 GA 0-bit

Trim Only

MO656F x 630 x RHR x LC

Double Cylinder Exit Device with Trim

6150F-2-36 x AU626F x 630

*Yale® exit devices and trims are processed separately. To aid in order processing, the device, trim and cylinder should be detailed as separate line items. These items can be ordered on one line item as shown, but they will be entered to the factory and acknowledged separately.

6100ED(F) Rim



The 6100ED(F) is a rim exit device to be used with single doors or pairs of doors constructed of metal, wood or composite materials. Designed for application in high-use areas, the 6100ED(F) comes in a variety of finishes and can be combined with a variety of trims to match any desired style.

Features

- Designed for wide stile doors
- 3/4" throw deadlocking stainless steel pullman latchbolt
- Available in double cylinder function (must specify handing)
- Non-handed for easy installation



Applications

- Single swing doors
- Pairs of doors with removable mullions
- Wide stile aluminum, metal, wood or composite door materials

Specifications

Rail Sizes:	-24 for 24" (60cm) doors -36 for 30" - 36" (76cm - 91cm) doors -42 for 36" - 42" (91cm - 107cm) doors -48 for 42" - 48" (107cm - 122cm) doors Alternate sizes can be special ordered. Consult Technical Product Support.
Door Thickness:	1-3/4" (44mm) standard. Optional thicknesses to 4-1/2"; specify when ordering.
Minimum Stile Width:	4-1/2" (114mm)
Projection:	3-1/4" (83mm) active; 2-1/2" (63.5mm) dogged
Latchbolt:	Stainless steel pullman style, 3/4" (19mm), deadlocking
Strike(s):	757F standard; 793 optional for pairs, panic only
Fasteners:	Machine screws or wood door screws standard for panic; sex nuts and bolts (SNB) supplied standard for fire
Handing:	Non-handed
ANSI/BHMA:	Certified ANSI/BHMA A156.3 Type 1 Grade 1 standards
Dogging:	Hex key dogging standard on panic; optional cylinder dogging (-5)
Shim Kit:	#623SK optional
Finishes:	See page 6 for finish options
Options:	Double cylinder function (-2); specify hand. Anti-pry bracket #625AP.





6150ED(F) Rim SquareBolt®

The rim SquareBolt® exit device's unique construction offers innovative protection. Its design provides greater latch engagement for higher security than standard rim devices can offer. Credit cards, crowbars, door rattling and shaking are resisted, significantly reducing the threat of unauthorized entry.

Features

- Larger bolt engagement
- Designed for maximum holding power
- Delivers higher security
- Non-handed for easy installation
- Can be retrofitted onto existing 7000 Series templated doors
- Fully adjustable surface-mounted 3/8" diameter roller strike complete with positive locking plate and shims
- Available in double cylinder function

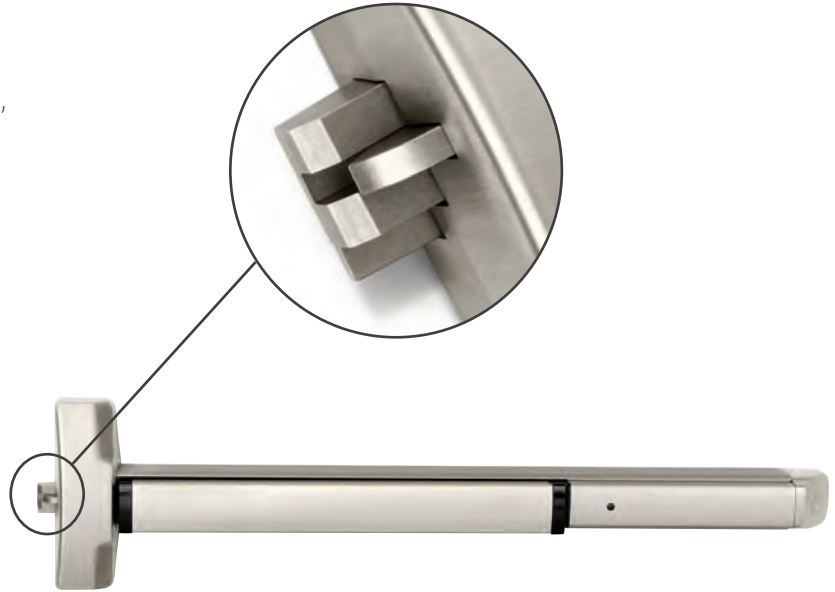

Applications

- Single swing doors
- Pairs of doors with removable mullions
- Wide stile aluminum, metal, wood or composite door materials

Specifications

Rail Sizes:	-24 for 24" (60cm) doors -36 for 30" - 36" (76cm - 91cm) doors -42 for 36" - 42" (91cm - 107cm) doors -48 for 42" - 48" (107cm - 122cm) doors Alternate sizes can be special ordered. Consult Technical Product Support.
Door Thickness:	1-3/4" (44mm) standard. Optional thicknesses to 4-1/2"; specify when ordering.
Minimum Stile Width:	4-1/2" (114mm)
Projection:	3-1/4" (83mm) active; 2-1/2" (63.5mm) dogged
Latchbolt:	1" (25mm) slide projection bolt with full 3/4" (19mm) projection
Strike(s):	757F standard; 793 optional for pairs, panic only
Fasteners:	Machine screws or wood door screws standard for panic; sex nuts and bolts (SNB) supplied standard for fire
Handing:	Non-handed
ANSI/BHMA:	Certified ANSI/BHMA A156.3 Type 1 and 28 Grade 1 standards
Dogging:	Hex key dogging standard on panic; optional cylinder dogging (-5)
Shim Kit:	#623SK optional
Finishes:	See page 6 for finish options
Options:	Double cylinder function (-2); specify hand. Anti-pry bracket #625AP.



6170ED(F) Surface Vertical Rod



The 6170ED(F) is a surface vertical rod exit device to be used on wide stile and flush doors up to 10' where one- or two-point latching is desired. A Less Bottom Rod (LBR) option is available.

Features

- Designed for wide stile and flush doors
- Handed. Specify hand (field reversible)
- Interlocking top strike and latch mounting plate
- Available less bottom rod (LBR option)

Applications

- Single swing doors
- Pairs of doors with removable mullions
- Wide stile aluminum, metal, wood or composite door materials

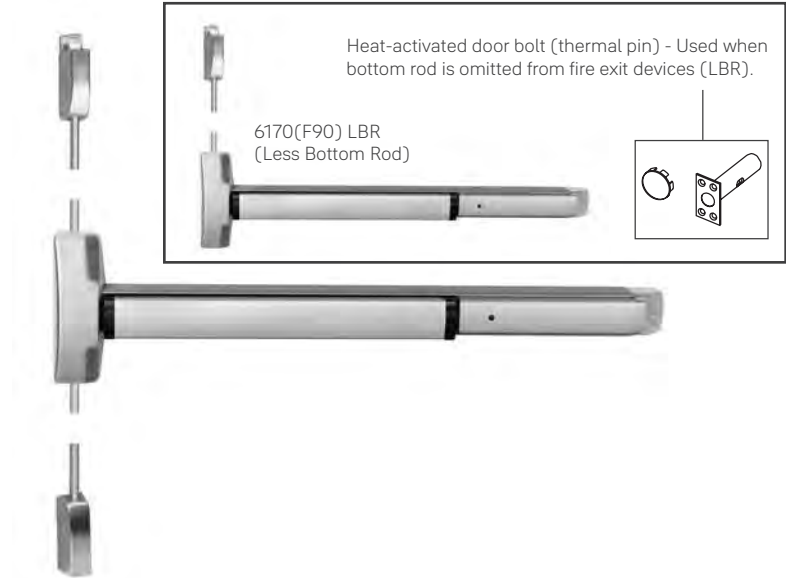

Specifications

Rail Sizes:	-24 for 24" (60cm) doors -36 for 30" - 36" (76cm - 91cm) doors -42 for 36" - 42" (91cm - 107cm) doors -48 for 42" - 48" (107cm - 122cm) doors Alternate sizes can be special ordered. Consult Technical Product Support.
Door Thickness:	1-3/4" (44mm) standard. Optional thicknesses to 4-1/2"; specify when ordering.
Minimum Stile Width:	4-1/2" (114mm)
Projection:	3-1/4" (83mm) active; 2-1/2" (63.5mm) dogged
Latchbolt:	Top: 3/4" (19mm) pullman style with auto deadlatching; Bottom 5/8" (16mm) deadbolt, held retracted during door swing
Strike(s):	Top: 726; Bottom: flush-mounted 790. 794 floor strike optional (threshold openings)
Fasteners:	Machine screws or wood door screws standard for panic; sex nuts and bolts (SNB) supplied standard for fire
Handing:	Handed, please specify. Field reversible.
ANSI/BHMA:	Certified ANSI/BHMA A156.3 Type 2 Grade 1 standards
Dogging:	Hex key dogging standard on panic; optional cylinder dogging (-5)
Shim Kit:	#624SK optional
Finishes:	See page 6 for finish options
Options:	Rod extensions, Less Bottom Rod (LBR)
Door Height:	7' (213cm) standard. Optional heights 8', 9' and 10'.
Vertical Rods:	1/2" OD brass, bronze or stainless steel with rod guides





6160ED(F) Concealed Vertical Rod

The 6160ED(F) is a concealed vertical rod exit device to be used on wood and metal doors up to 10' where one- or two-point latching is desired. A Less Bottom Rod (LBR) option is available.

Features

- Designed for wide stile and flush doors
- Handed. Specify hand (field reversible)
- Mortised top strike
- Available less bottom rod (LBR option)

Applications

- Single swing doors
- Pairs of doors with removable mullions
- Wide stile aluminum, metal, wood or composite door materials

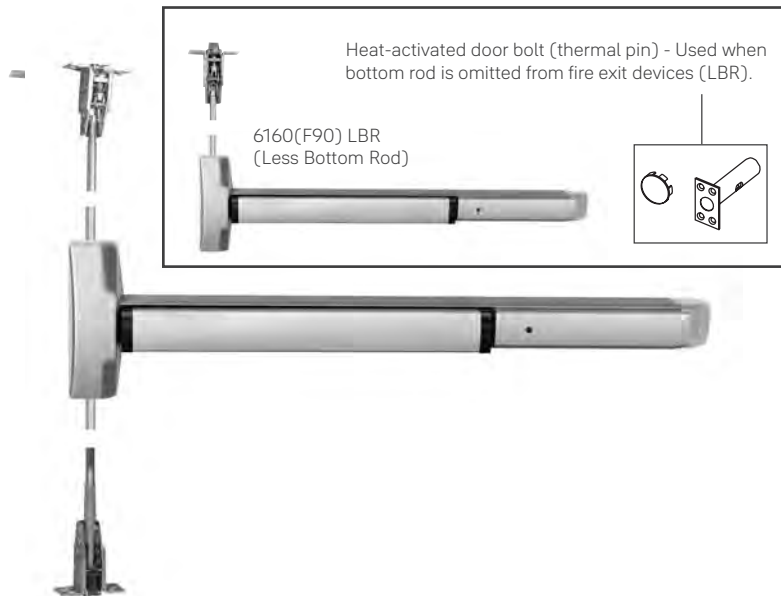

Specifications

Rail Sizes:	-24 for 24" (60cm) doors -36 for 30" - 36" (76cm - 91cm) doors -42 for 36" - 42" (91cm - 107cm) doors -48 for 42" - 48" (107cm - 122cm) doors Alternate sizes can be special ordered. Consult Technical Product Support.
Door Thickness:	1-3/4" (44mm) standard. 2" and 2-1/4" (51mm and 57mm) optional, specify when ordering.
Minimum Stile Width:	4-1/2" (114mm)
Projection:	3-1/4" (83mm) active; 2-1/2" (63.5mm) dogged
Latchbolt:	Top: 3/4" (19mm) pullman style with auto deadlatching; Bottom 5/8" (16mm) deadbolt, held retracted during door swing
Strike(s):	Top: Mortised 761; Bottom: flush-mounted 790. 794 floor strike optional (threshold openings)
Fasteners:	Machine screws or wood door screws standard for panic; sex nuts and bolts (SNB) supplied standard for fire
Handing:	Handed, please specify. Field reversible.
ANSI/BHMA:	Certified ANSI/BHMA A156.3 Type 7 and 8 Grade 1 standards
Dogging:	Hex key dogging standard on panic; optional cylinder dogging (-5)
Shim Kit:	#623SK optional
Finishes:	See page 6 for finish options
Options:	Rod extensions, Less Bottom Rod (LBR)
Door Height:	Standard door height adjustable to 8'(244cm). Optional heights 9' and 10'.
Vertical Rods:	1/2" (13mm) OD, telescoping tubular rods



6130ED(F) Mortise



The 6130ED(F) is an exit device integrated with the Yale® 8700 Series Mortise Lock for use on single doors or active leaf of a pair of doors where life safety and extra security are required. The 8700 Series Mortise Lock is modified for use with exit devices only.



Features

- Designed for wide stile and flush doors
- Handed. Specify hand (field reversible)
- Two-piece mechanical 3/4" throw deadlocking stainless steel latchbolt
- Available in double cylinder function

Applications

- Single swing doors
- Pairs of doors with removable mullions
- Wide stile aluminum, metal, wood or composite door materials

Order as follows, according to function.

6130ED-K5(F)	Exit only, no trim
6130ED-L5(F)	(02) Entry by rigid lever when dogged.
	(03) Key retracts latchbolt. Electrical control for 650F Series trim, w/wo key override.
6130ED-T5(F)	(02) Entry by pull when dogged.
	(03) Key retracts latchbolt.
6130ED-L8(F)	(08) Entry by lever lock/unlocked by key or lever only (passage).
6130ED-L8(F)-2	(08) Entry by lever lock/unlocked by key either side or lever only (passage).

Specifications

Rail Sizes:	-24 for 24" (60cm) doors -36 for 30" - 36" (76cm - 91cm) doors -42 for 36" - 42" (91cm - 107cm) doors -48 for 42" - 48" (107cm - 122cm) doors Alternate sizes can be special ordered. Consult Technical Product Support.
Door Thickness:	1-3/4" (44mm) standard. 2" and 2-1/4" (51mm and 57mm) optional, specify when ordering.
Minimum Stile Width:	4-1/2" (114mm)
Projection:	3-1/4" (83mm) active; 2-1/2" (63.5mm) dogged
Latchbolt:	Two piece mechanical 3/4" (19mm) deadlocking stainless steel with anti-friction insert and auxilliary deadlocking latch
Strike(s):	798 curved lip; 612 or 712 optional for pairs with astragals, 618 or 718 optional open-back strike. See page 45 for more information.
Fasteners:	Machine screws or wood door screws standard for panic; sex nuts and bolts (SNB) supplied standard for fire
Handing:	Handed, please specify.
ANSI/BHMA:	Certified ANSI/BHMA A156.3 Type 3 Grade 1 standards
Dogging:	Hex key dogging standard on panic; optional cylinder dogging (-5)
Shim Kit:	#623SK optional
Finishes:	See page 6 for finish options
Options:	Double cylinder function (-2); specify hand





6200ED Rim

The 6200ED is a narrow stile rim exit device compatible with the aesthetics and functional requirements of contemporary doors. The 6200ED comes in varied finishes and can be combined with a variety of trims to match any desired style.

Features

- Designed for narrow stile doors
- 3/4" throw deadlocking stainless steel pullman latch
- Non-handed for easy installation
- Used with narrow stile trim



Applications

- Single swing narrow stile doors
- Pairs of narrow stile doors with removable mullions
- Metal and aluminum doors
- 6200ED for panic-rated doors only

Specifications

Rail Sizes:	-24 for 24" (60cm) doors -36 for 30" - 36" (76cm - 91cm) doors -42 for 36" - 42" (91cm - 107cm) doors -48 for 42" - 48" (107cm - 122cm) doors Alternate sizes can be special ordered. Consult Technical Product Support.
Door Thickness:	1-3/4" (44mm) standard. 2" and 2-1/4" (51mm and 57mm) optional, specify when ordering.
Minimum Stile Width:	Pair of doors: 3-1/8" (79mm), does not include glass stop. Single door: 2-5/8" (67mm), does not include glass stop.
Projection:	3-1/4" (83mm) active; 2-1/2" (63.5mm) dogged
Latchbolt:	Stainless steel pullman style, 3/4" (19mm), deadlocking
Strike(s):	759 standard; 793 optional for pairs, panic only
Fasteners:	Machine screws or wood door screws standard for panic
Handing:	Non-handed
ANSI/BHMA:	Certified ANSI/BHMA A156.3 Type 4 Grade 1 standards
Dogging:	Hex key dogging standard on panic; optional cylinder dogging (-5)
Shim Kit:	#623NS optional
Finishes:	See page 6 for finish options
Options:	Anti-pry bracket #625AP.



6250ED Rim SquareBolt®



The unique construction of the SquareBolt exit device offers innovative protection. Its design provides greater latch engagement for higher security than standard rim devices can offer. Credit cards, crowbars, door rattling and shaking are resisted, significantly reducing the threat of unauthorized entry. The 6250ED SquareBolt is designed for narrow stile doors.

Features

- Larger bolt engagement
- Designed for maximum holding power
- Delivers higher security
- Non-handed for easy installation
- Can be retrofitted onto existing 7200 Series templated doors
- Fully adjustable surface mounted 3/8" diameter roller strike complete with positive locking plate and shims
- Used with narrow stile trim

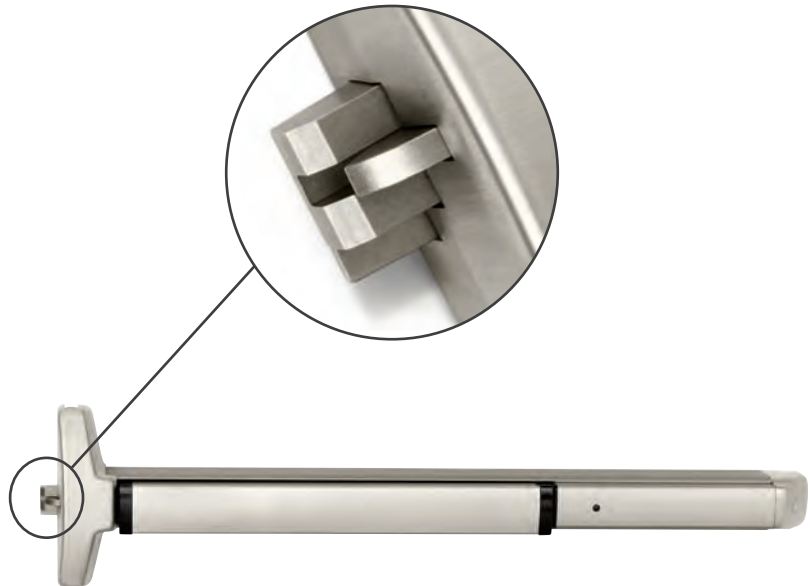

Applications

- Single swing narrow stile doors
- Pairs of narrow stile doors with removable mullions
- Metal and aluminum doors
- 6250ED for panic-rated doors only

Specifications

Rail Sizes:	-24 for 24" (60cm) doors -36 for 30" - 36" (76cm - 91cm) doors -42 for 36" - 42" (91cm - 107cm) doors -48 for 42" - 48" (107cm - 122cm) doors Alternate sizes can be special ordered. Consult Technical Product Support.
Door Thickness:	1-3/4" (44mm) standard. 2" and 2-1/4" (51mm and 57mm) optional, specify when ordering.
Minimum Stile Width:	Pair of doors: 3-1/8" (79mm), does not include glass stop. Single door: 2-5/8" (67mm), does not include glass stop.
Projection:	3-1/4" (83mm) active; 2-1/2" (63.5mm) dogged
Latchbolt:	1" (25mm) slide projection bolt with full 3/4" (19mm) projection
Strike(s):	759 standard; 793 optional for pairs, panic only
Fasteners:	Machine screws or wood door screws standard for panic
Handing:	Non-handed
ANSI/BHMA:	Certified ANSI/BHMA A156.3 Type 4 and 28 Grade 1 standards
Dogging:	Hex key dogging standard; optional cylinder dogging (-5)
Shim Kit:	#623NS optional
Finishes:	See page 6 for finish options
Options:	Anti-pry bracket #625AP.





6210ED Surface Vertical Rod

The 6210ED is a narrow stile surface vertical rod exit device to be used on narrow stile, aluminum and metal doors where two-point latching is desired.

Features

- Designed for narrow stile doors
- Handed. Specify hand (field reversible)
- Bottom deadbolt for secure latching
- Fully adjustable roller strike

Applications

- Pairs of narrow stile doors
- Metal and aluminum doors
- For panic-rated doors only



Specifications

Rail Sizes:	-24 for 24" (60cm) doors -36 for 30" - 36" (76cm - 91cm) doors -42 for 36" - 42" (91cm - 107cm) doors -48 for 42" - 48" (107cm - 122cm) doors Alternate sizes can be special ordered. Consult Technical Product Support.
Door Thickness:	1-3/4" (44mm) standard. 2" and 2-1/4" (51mm and 57mm) optional, specify when ordering.
Minimum Stile Width:	2-3/4" (70mm), does not include glass stop
Projection:	3-1/4" (83mm) active; 2-1/2" (63.5mm) dogged
Latchbolt:	Top: 3/4" (19mm) pullman style with auto deadlatching; Bottom 5/8" (16mm) deadbolt, held retracted during door swing
Strike(s):	Top: 791 roller strike; Bottom: 790 flush mount. 794 floor strike optional (threshold openings)
Fasteners:	Machine screws or wood door screws standard for panic
Handing:	Handed, please specify. Field reversible.
ANSI/BHMA:	Certified ANSI/BHMA A156.3 Type 5 Grade 1 standards
Dogging:	Hex key dogging standard on panic; optional cylinder dogging (-5)
Shim Kit:	#624NS optional
Finishes:	See page 6 for finish options
Options:	Rod extensions, bottom pullman latch
Door Height:	7' (213cm) standard. Optional heights 8', 9' and 10'.
Vertical Rods:	1/2" (13mm) OD tubular brass, bronze or stainless steel with rod guides

6220ED Concealed Vertical Rod



The 6220ED is a narrow stile concealed vertical rod exit device to be used on narrow stile, aluminum and metal doors where two-point latching is desired.

Features

- Designed for narrow stile doors
- Handed. Specify hand (field reversible)
- Bottom deadbolt for secure latching
- Fully adjustable roller strike

Applications

- Pairs of narrow stile doors
- Metal and aluminum doors
- For panic-rated doors only



Specifications

Rail Sizes:	-24 for 24" (60cm) doors -36 for 30" - 36" (76cm - 91cm) doors -42 for 36" - 42" (91cm - 107cm) doors -48 for 42" - 48" (107cm - 122cm) doors Alternate sizes can be special ordered. Consult Technical Product Support.
Door Thickness:	1-3/4" (44mm) standard. 2" and 2-1/4" (51mm and 57mm) optional, specify when ordering.
Minimum Stile Width:	2-3/4" (70mm), does not include glass stop
Projection:	3-1/4" (83mm) active; 2-1/2" (63.5mm) dogged
Latchbolt:	Top: 3/4" (19mm) pullman style with auto deadlatching; Bottom 5/8" (16mm) deadbolt, held retracted during door swing
Strike(s):	Top: 791 roller type; Bottom: flush-mounted 790; 794 floor strike optional (threshold openings)
Fasteners:	Machine screws or wood door screws standard for panic
Handing:	Handed, please specify. Field reversible.
ANSI/BHMA:	Certified ANSI/BHMA A156.3 Type 6 Grade 1 standards
Dogging:	Hex key dogging standard on panic; optional cylinder dogging (-5)
Shim Kit:	#623NS optional
Finishes:	See page 6 for finish options
Options:	Rod extensions, bottom pullman latch (panic only)
Door Height:	Standard door height adjustable to 8' (244cm). Optional heights -9', -10'.
Vertical Rods:	1/2" (13mm) OD, telescoping tubular rods



Trim Designs



Escutcheons

420F Series	480F Series	500F Series	620F/650F Series	630F/660F/670F Series
				
Projection: see levers	Projection: 2-13/32" (61mm)	Projection: see levers	Projection: see levers	Projection: 2-1/8" (54mm)

Roses

440F Series	540F Series
	
Projection: 3-1/2" (89mm)	Projection: 3-1/2" (89mm)

Standard Levers





























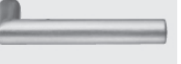



Arcadia AR	Augusta AU	Carmel CR 	Jefferson JN 
			
Projection: 3-1/4" (82mm)	Projection: 2-5/8" (61mm)	Projection: 3-1/8" (79mm)	Projection: 2-9/16" (65mm)
Monroe MO 	Pacific Beach PB 	Pinehurst PN 	Virginia VI
			
Projection: 3" (76mm)	Projection: 3-5/16" (84mm)	Projection: 3-1/16" (78mm)	Projection: 3-1/8" (79mm)

Note: Projection dimensions are provided using the 620F Series escutcheon plates.



Reflections® Levers



Hudson	TB  Projection 3-1/16" (78mm)	UB  Projection 3-1/4" (83mm)	TC  Projection 3" (76mm)	TD  Projection 3-7/16" (87mm)	UC  Projection 3-7/16" (87mm)	
Spree	RS  Projection 3-1/8" (79mm)	RT  Projection 3-1/8" (79mm)	RU  Projection 3-13/32" (87mm)	RV  Projection 3" (76mm)		
Seine	TE  Projection 3" (76mm)	TG  Projection 2-13/16" (61mm)	TI  Projection 3-3/8" (85mm)	TO  Projection 3-1/2" (89mm)	TJ  Projection 3-1/16" (78mm)	TK  Projection 3-1/4" (83mm)
Thames	TM  Projection 3-1/16" (78mm)	TN  Projection 3-1/16" (78mm)	TP  Projection 3-5/16" (84mm)	TR  Projection 3-1/16" (78mm)	TS  Projection 3-1/8" (80mm)	TQ  Projection 3-1/16" (78mm)
Victoria	TT  Projection 2-11/16" (68mm)	TU  Projection 3-1/4" (83mm)	TV  Projection 3-1/2" (89mm)	TW  Projection 3" (76mm)	UW  Projection 3-7/16" (87mm)	TX  Projection 3-5/8" (92mm)
Victoria, continued	UX  Projection 3-7/16" (87mm)	TY  Projection 3-5/16" (84mm)	TZ  Projection 3-7/16" (87mm)			
Niagara	MA  Projection 2-13/16" (71mm)	RA  Projection 3-11/16" (94mm)	RB  Projection 2-13/16" (71mm)	RC  Projection 2-13/16" (71mm)		

Note: Projection dimensions are provided using the 620F Series escutcheon plates.

Note: The following Reflections levers are not available in 629 or 630 finish: Victoria TT, TU, TV, TW, TX, TY, UW, UX, TZ; Seine TG, TJ, TK, TO, TE, TI. Please consider the 618 or 619 finish as an alternative. Reflections levers are not available with knurling option.





6100ED Series Wide Stile Trims



420F Series Escutcheon Trim



- Certified ANSI/BHMA A156.3, Grade 1
- Thrubolt. 1-3/4" (44mm) door standard. For doors thru 2-1/4" (57mm) or shim-mounted devices, specify on order.
- Dimensions: 2-1/2" x 9-1/2" x 1/4" (64mm x 241mm x 6mm)
- Available only with AU/MO/PB levers
- Cylinders not included. For rim cylinders, see page 40.
- Finishes: 630, 689, 691, 693 and 695
- 1-year warranty
- Ordering Example: PB428F x LHR x 689

								
Applications	Cylinder	Exit Only Blank Plate	Nightlatch	Classroom/ Storeroom	Nightlatch	Dummy Free Wheeling	Passage	Dummy Rigid Lever
6100ED(F), 6150ED(F), 6160ED(F), 6170ED(F)	Rim	420F	421F*	426F	427F*	428F	428F	429F
ANSI		01	03	08/09	03	02	14	02

*Not recommended for use with 6170ED(F) surface vertical rod exit devices or 6160ED(F) concealed vertical rod devices.
Note: 09 and Free Wheeling 02 achieved with single trim modification at installation.

6100ED Series Wide Stile Trims



620F and 650F Series Escutcheon Trim



- Certified ANSI/BHMA A156.3, Grade 1
- Trim through-bolts to exit device for strength
- Beveled sides improve attack resistance
- Solid forged/cast escutcheon and free-wheeling trim for ideal protection
- Flush cylinder in 6-pin applications for additional security
- 1-3/4" (44mm) door standard. For doors through 2-1/4" (57mm) or shim-mounted devices, specify on order.
- Dimensions: 3" x 10-1/4" x 13/16" (76mm x 260mm x 19mm)
- Cylinders not included. See page 41-42 for cylinder options. 1-1/2" mortise cylinder required for mortise trim.
- Available with AR, AU, CR, JN, MO, PB, PN, VI lever designs. See page 17.
 - Finishes: 605, 606, 613E, 629, 630, BSP
- Available with Reflections® lever designs. See page 18.
 - Finishes: 605, 606, 613E, 629, 630, BSP
- Trim ordering example: AU626F x 626 x RHR
- 10-year limited warranty

Application	Cylinder	Exit Only Blank Plate	Classroom Cylinder Controls Lever	Storeroom Cylinder Controls Lever	Nightlatch Cylinder by Lever	Passage	Dummy Trim Free-Wheeling	Dummy Rigid Lever
6100ED(F) 6150ED(F) 6160ED(F) 6170ED(F)	Rim	620F	626F	626F ¹	627F ²	628F	628F ¹	629F
6130ED(F)	Mortise	620F	656F	—	656F	658F	—	658F
6100ED(F)-2 6150ED(F)-2	Rim x Rim	—	626F	—	—	—	—	—
6130ED(F)-2	Mortise x Rim	—	656F	—	—	—	—	—
ANSI		01	08	09	03	14	02	02

1. 09 function is Free Wheeling; Free Wheeling for 02 function achieved with single trim modification at installation.

2. Not recommended for use with vertical rod devices.

For 626, 629 & 630 finishes the escutcheon is plated to simulate stainless steel.

For 629 & 630 finishes the standard levers are plated to simulate stainless steel.

Free-Wheeling is not available on mortise trim.

For 620F Series trim, optional door thickness available up to 4-1/2", specify on order.





6100ED Series Wide Stile Trims



630F, 660F and 670F Series Pull/Thumbpiece Trim



- Certified ANSI/BHMA A156.3, Grade 1.
- Trim through-bolts to exit device for added strength.
- Beveled sides improve attack resistance.
- Flush cylinder in 6-pin applications for additional security.
- 1-3/4" (44mm) door standard. For doors through 2-1/4" (57mm) or shim-mounted devices, specify on order.
- Plate Dimensions: 2-3/4" x 15-1/2" x 5/8" (70mm x 394mm x 16mm).
- Pull Dimensions: 6-7/16" (164mm) on centers x 2-1/8" (54mm) projection.
- Cylinders not included. See page 41-42 for cylinder options. 1-1/2" mortise cylinder required for mortise trim.
- Finishes: 605, 606, 613E, 629, 630, BSP
- Trim ordering example: 633F x 630
- 10-year limited warranty.

						
ANSI No.	03	05	06	02	15	
Applications	Cylinder	Nightlatch Cylinder by Pull	Classroom Cylinder Controls T-Piece	Storeroom Cylinder Controls T-Piece	Dummy Trim Pull Plate	Passage Active T-Piece
6100ED(F) 6150ED(F) 6160ED(F) 6170ED(F)	Rim	632F ²	633F	633F ¹	634F	635F
6100ED(F)-2 6150ED(F)-2	Rim x Rim	—	633F	—	—	—
6130ED(F)	Mortise	662F K5F	673F ³ T8F	—	634F K5F	675F ³ T8F
6130ED(F)-2	Mortise x Mortise				—	—

1. 06 achieved with single trim modification at installation.
 2. Not recommended for use with vertical rod exit devices.
 3. Available for 1-3/4" thick doors only.
 For 630F Series trim, optional door thickness available up to 4-1/2", specify on order.
 For 626, 629 & 630 finishes the escutcheon is plated to simulate stainless steel.

6100ED Series Wide Stile Trims



440F Series Rose Trim



- Certified ANSI/BHMA A156.3, Grade 1.
- 440F rose trim for stock doors (161 Prep).
- 1-3/4" (44mm) door standard. For doors thru 2-1/4" (57mm) or shim-mounted devices, specify on order.
- Cylinders included, accepts component cylinders. See page 43.
- Only available with AU, MO, and PB levers
- Finishes: 613E, 626, 689, 691, 693, 695, BSP.
- "B" trim prefix – Lever trim accepting small format interchangeable cores (SFIC). Specify 6- or 7-pin.
(Example: B-AU446F)
- Please specify when ordering 1210 LFIC prep.
- 2-year warranty.
- Ordering example: AU446F x RHR x 626.

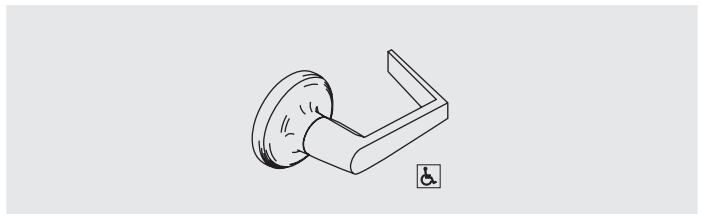
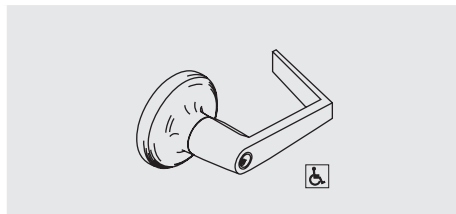

Applications	Nightlatch Access by Key	Classroom	Dummy Trim Free Wheeling Lever	Passage Lever	Dummy Trim Rigid Lever
6100ED(F), 6150ED(F), 6160ED(F), 6170ED(F)	441F*	446F	448F	448F	449F
ANSI	03	08	02	14	02

*Not recommended for use with vertical rod devices.







6100ED Series Wide Stile Trims



510F Series Pull/Thumbpiece Trim



- Certified ANSI/BHMA A156.3, Grade 1.
- Trim thrubolts to exit device for strength.
- 1-3/4" (44mm) door standard. For doors through 2-1/4" (57mm) or shim-mounted devices, specify on order.
- Plate Dimensions: 1-5/8" x 15-1/4" x 5/8" (41mm x 387mm x 16mm).
- Pull Dimensions: 6-7/16" (164mm) on centers x 2-1/8" (54mm) projection.
- Accepts rim cylinders. Cylinders not included. See page 43 for cylinder options.
- Finishes: 605, 606, 609, 611, 612, 613E, 616, 619, 620, 626, 629, 630, 693, BSP
- Trim ordering example: 512F x 630
- 1-year limited warranty.

						
Applications	Nightlatch Access by Key	Classroom/ Storeroom Cylinder Controls Thumbturn	Dummy Trim	Passage	Classroom/ Storeroom Cylinder Controls T-Piece	Passage
6200ED, 6210ED, 6220ED, 6250ED	512F^	513F	514F	517F	518F	519F
ANSI	03	11/12	02	16	05/06	15

6100ED Series Wide Stile Trims



540F Series Rose Trim



- Certified ANSI/BHMA A156.3, Grade 1.
- 540F rose trim for stock doors.
- Trim through-bolts to exit device for strength.
- 1-3/4" (44mm) door standard. For doors through 2-1/4" (57mm) or shim-mounted devices, specify on order.
- AU, PB and MO trim designs.
- Accepts cylindrical type cylinders. Cylinders included, see page 43 for cylinder options.
- Please specify when ordering 1210 LFIC prep.
- Finishes: 605, 606, 613E, 625, 626, BSP.
- 3-year limited warranty.

"B" trim prefix	Lever trim accepting all small format interchangeable cores. 6- or 7-pin (Example: B-AU546F)
"M" trim prefix	Lever trim accepting Medeco® (32 Series) and ASSA® large format interchangeable cores. Available in AU lever only. 6-pin only. (Example: M-AU546F)
"S" trim prefix	Lever trim accepting Schlage® standard cylinders. 6-pin only. (Example: S-AU546F)
"SI" trim prefix	Lever trim accepting Schlage® large format interchangeable cores. 6-pin only. (Example: SI-AU546F)

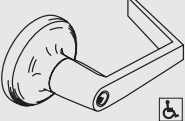
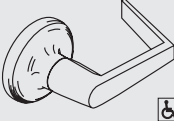
Applications					
	Nightlatch Access by Key	Classroom Cylinder Controls Lever	Passage Lever	Dummy Trim Free-Wheeling Lever	Dummy Trim Rigid Lever
6100ED(F), 6150ED(F), 6160ED(F), 6170ED(F)	541F	546F	548F	548F	549F
ANSI	03	08	14	02	02

121NL Nightlatch Access By Key, Cylinder Only

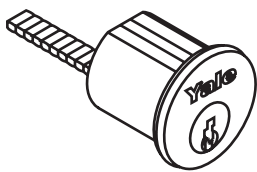

- Application: Available for all wide & narrow stile rim and SquareBolt® devices. Not recommended for surface or concealed vertical rod devices.
- Must specify rim cylinder when ordering. See page 40 for cylinder options.
- Cylinder collar 1765.250 furnished standard for 1-3/4" thick doors.
- For 1109, 5109, K300, K640, A640 and 2109 cylinders:
 - Screw part number 34-2311-8738-048
 - Backplate part number 34-0010-1015-059
- For 1193, 5193 and K840 cylinders:
 - Screw part number 10-1193-1018-048
 - Backplate part number 34-0010-1015-059

Function Description	Nightlatch Access by Key
Model No.	121NL
ANSI	03



6200ED Series Narrow Stile Trims

480F Series Offset Pull Trim



- 1-3/4" (44mm) door standard. For doors through 2-1/4" (57mm) or shim-mounted devices, specify on order.
- Plate Dimensions: 1-3/4" x L x 3/16" (44mm x L x 5mm) L = Overall plate length is 2-1/4" (57mm) longer than pull dimension.
- Pull Dimensions:
 - 480F and 481F trim have a 7-1/4" (184mm) pull length on centers which through-bolts to exit device for strength.
 - 482F and 483F trim have a 9" (229mm) pull length on centers and are not thrubolt to allow pulls of different lengths to be utilized. Longer lengths of 15" (381mm), 18" (457mm) and up to 30" (762mm) are available.
- 2-13/32" (61mm) projection.
- Cylinders not included. See page 40-42 for cylinder options.
- Finishes: 605, 606, 613E, 629, 630, BSP
- Trim ordering example: 481F x 630 x LHR
- 1-year limited warranty

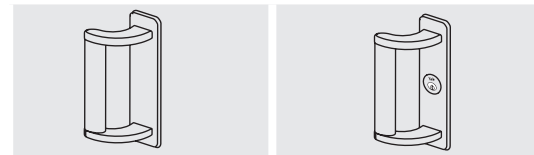

Applications	Cylinder	Dummy Pull	Nightlatch Access by Key
6200ED, 6210ED(F), 6220EDM(F), 6250ED(F)	Rim	480F 482F	481F* 483F*
ANSI	--	02	03

*Not recommended for use with vertical rod exit devices.
For 626, 629 & 630 finishes the escutcheon is plated to simulate stainless steel.

500F Series Escutcheon Narrow Stile Trim



- Certified ANSI/BHMA A156.3, Grade 1.
- Trim through-bolts to exit device for strength.
- 1-3/4" (44mm) door standard. For doors through 2-1/4" (57mm) or shim-mounted devices, specify on order.
- Dimensions: 1-5/8" x 9-1/2" x 1/4" (41mm x 241mm x 6mm)
- Cylinders not included. See page 40-42 for cylinder options.
- Available with AR, AU, CR, JN, MO, PB, PN, VI, HA lever designs. See page 17-18.
 - Finishes: 605, 606, 613E, 629, 630, BSP
- Available with Reflections® lever designs. See page 18.
 - Finishes: 605, 606, 613E, 629, 630, BSP
- Trim ordering example: AU506F x 626 x RHR.
- 1-year limited warranty.

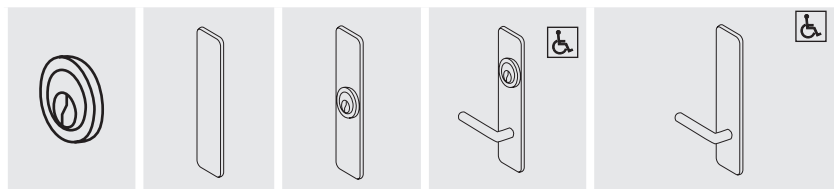

Applications	Nightlatch Access by Key	Exit Only Blank Plate	Nightlatch Access by Key	Classroom/Storeroom Cylinder Controls Lever	Passage or Dummy	Dummy Trim
6200ED, 6210ED, 6220ED, 6250ED	121NL ²	500F	501F ²	506F ¹	508F ¹	509F
ANSI	03	01	03	08/09	14/02	02

1. 09 function is Free Wheeling; Free Wheeling for 02 function achieved with single trim modification at installation.
2. Not recommended for use with vertical rod devices.
For 629 & 630 finishes the standard levers are plated to simulate stainless steel.

Electrified Options



The Yale® 6000ED Series exit devices offer a complete range of electrical options. A continuity in appearance, security and functions with the 6000ED Series mechanical exit device is maintained. These electrified exit devices may be integrated into the monitoring security and alarm systems of most buildings.

Electrified Options

Model #	Exit Device Description	A	A- ALR	B	G	O	P	S	SAFE	SECURE	690F	691F
6100ED(F)	Rim Device (Wide)	x	x	x	x	x	x	x			x	x
6130ED(F)	Mortise Device (Wide)	x		x	x	x	x	x	x	x		
6150ED(F)	Rim SquareBolt® Device (Wide)	x		x	x	x	x	x			x	x
6160ED(F)	Concealed Vertical Rod (Wide)	x		x	x	x	x	x				
6170ED(F)	Surface Vertical Rod (Wide)	x		x	x	x	x	x			x	x
6200ED	Rim Device (Narrow)	x		x	x		x	x				
6210ED	Surface Vertical Rod (Narrow)	x		x	x		x	x				
6220ED	Concealed Vertical Rod (Narrow)	x		x	x		x	x				
6250ED	Rim SquareBolt Device (Narrow)	x		x	x		x	x				

Electrified Hardware Option Descriptions

A	Alarm Option
A-ALR	Alarm with Red Screenprinted Pushpad*
B	Touchbar Monitor
G	Electric Dogging
O	Trim Monitor Switch
P	Electric Latch Retraction
S	Latchbolt Position Monitor
SAFE	Fail Safe Operation (Mortise)
SECURE	Fail Secure Operation (Mortise)
690F	Fail Safe Electrified Trim
691F	Fail Secure Electrified Trim



6100ED-A-ALR

Note: The following options cannot be ordered together:

- 1) P or G
- 2) B or A
- 3) 690F or 691F

*Only available with 6100ED and ED(F) in 36" and in 622 black finish

Order options: 6100ED-A-ALR x 36" x 622 or 6100EDF-A-ALR x 36" x 622

What normally took an hour or more to connect now takes minutes. Yale electrified exit devices and trims are equipped with ElectroLynx® connectors. As a standard feature, these "plug & play" connectors link power from the incoming source to electrified locking products, including hinges, locks, exit devices, magnetic holders and strikes.



Note: Electrified door hardware with ElectroLynx® connectors require a compatible number of lead wires attached to the door hinge.



Electrified Options

Electric Latch Retraction "P"

Operation

Allows the latchbolt to be retracted electrically for momentary or maintained periods of time from a remote location. The exit device bolt remains retracted for as long as the device is energized. Removal of power returns the device to the life safety, self-latching mechanical mode. Easy interface with central or local fire alarm systems, automatic door operators, hands-free actuation devices, and access control systems. Allows free egress at all times. Manual hex key dogging standard on non-rated devices.

Electrical Specifications

Solenoid Assembly

- Continuous duty
- 9 amp inrush
- Requires a 4-wire minimum pivot or hinge to transfer power from frame to door.
- Requires the 782 controller for operation (USING ANY OTHER POWER SUPPLY VOIDS THE WARRANTY OF THE DEVICE.)

Electrified System Guide

For use with:

- 6100EDP Latch Retraction
- 782 Controller
- Automatic Door Operator by Norton®
- ADA Pushbuttons by Norton®
- 700 Wave to Open Switches by Norton
- QC8 Power Transfer Hinge by McKinney®

Operation

- Exit device allows free egress at all times.
- Activating the interior or exterior pushbutton retracts the latchbolt in the device and the door automatically opens. Door closes and relatches after hold open time has elapsed in the operator.

For use with:

- 6100EDPBOS, Exit Device with Touchbar, Outside Trim and Bolt Position Monitors
- 782 Controller
- Momentary Pushbutton with Red and Green LED
- DPS (door position switch) by Securitron®
- TSB-C Door Cord by Securitron®

Operation

- Exit device allows free egress at all times.
- Activating the 402 x L2 push button retracts the latchbolt from a remote location.
 - The Red LED indicates that the door is closed and latched.
 - The Green LED illuminates when any of the following situations occur:
 - The pushpad is depressed
 - Tampering or retraction of the latchbolt
 - Operation of outside trim
 - Opening of door

Listings

UL/cUL listed for panic and fire exit hardware. Fire-rated devices must be wired into an automatic fire alarm system.

Applications

Rim: 6100ED(F), 6200ED
 SquareBolt®: 6150ED(F), 6250ED
 SVR: 6170ED(F), 6210ED
 CVR: 6160ED(F), 6220ED
 Mortise: 6130ED(F)

Ordering

Suffix "P" to the Model Number. Ex: 6100P.

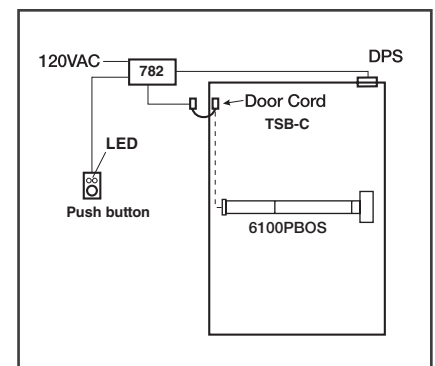
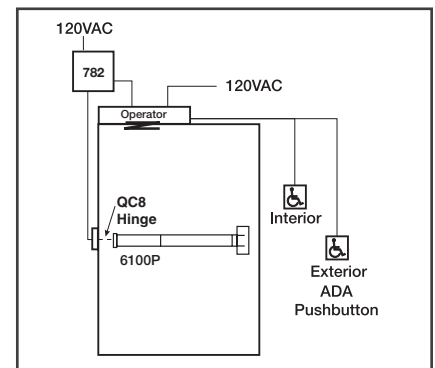

Electrified Options



Electric Dogging "G"

Operation

Provides continuous latch retraction and pushpad dogging simultaneously. When power is applied to the device, depressing the pushpad will retract the latchbolt and continuously hold down the pushpad in the unlock position for push/pull operation. Removal or interruption of power will release the pushpad and the latchbolt will extend and secure the opening. For use in areas that require quiet door operation.

Exit device allows free egress at all times.

Electrical Specifications

2 Holding Magnets

- .35 amps @ 24VDC

Requires a 2-wire pivot or hinge and a standard 24VDC regulated and filtered power source (Recommended BPS power supplies)

Listings

UL/cUL listed for panic and fire exit hardware.

Fire-rated devices must be wired into an automatic fire alarm system.

Applications

Rim: 6100ED(F), 6200ED

SquareBolt®: 6150ED(F), 6250ED

SVR: 6170ED(F), 6210ED

CVR: 6160ED(F), 6220ED

Mortise: 6130ED(F)

Ordering

Suffix "G" to the Model Number. Ex: 6150G.

Electrified System Guide

For use with:

- 6100EDGBS Electric Dogging Device with Touchbar Monitor
- BPS Power Supply with fire alarm interface
- Keyswitch with a Red and a Green LED
- DPS (door position switch) by Securitron®
- QC12 Power Transfer Hinge by McKinney®

Operation

- Exit device allows free egress at all times.
- Activating the maintained keyswitch applies power to the 6100EDGBS device. The first mechanical depression of the pushpad will retract the latchbolt and hold the pushpad down in a dogged position. Fire alarm activation, interruption of power or turning the keyswitch off will release the pushpad and the latch will extend.
 - The Green LED illuminates when power is on, and the pushpad can be depressed and dogged.
 - The Red LED illuminates when power is off, the door is closed and the device is latched and secure.

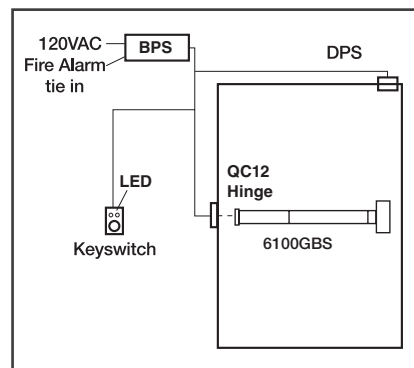



Electrified Options

Touchbar Monitor "B"

Provides indication of the pushpad being depressed. Used as a Request to Exit switch to shunt alarm systems, release electromagnetic locks or monitor egress.

Electrical Specifications: 4 Amps @ 250VAC contacts

Listings: UL/cUL listed for panic and fire exit hardware.

Applications: Rim: 6100ED(F), 6200ED
SquareBolt®: 6150ED(F), 6250ED
SVR: 6170ED(F), 6210ED
CVR: 6160ED(F), 6220ED
Mortise: 6130ED(F)

Ordering: Suffix "B" to the Model Number. Ex: 6170EDB.

Note: Not available with the "A" Alarm kit option.

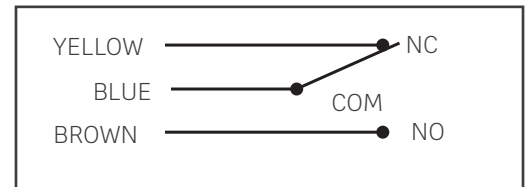

Trim Monitor Switch "O"

Provides indication of the trim being operated from the outside. Used as a Request to Enter signal switch to shunt alarms, also used to monitor entry.

Electrical Specifications: SPDT contacts rated 5 amp @ 28VDC

Listings: UL/cUL listed for panic and fire exit hardware.

Applications: Rim: 6100ED(F)
SquareBolt®: 6150ED(F)
SVR: 6170ED(F)
CVR: 6160ED(F)
Mortise: 6130ED(F)

Ordering: Suffix "O" to the Model Number. Ex: 6150EDO.

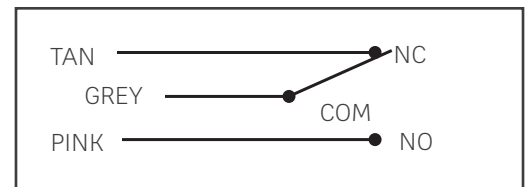

Latchbolt Position Monitor "S"

Provides indication on the position of the latchbolt. Used with security systems to monitor the latchbolt, also used to activate automatic door operators upon latch retractions.

Electrical Specifications: SPDT contacts rated 5 amp @ 28VDC

Listings: UL/cUL listed for panic and fire exit hardware.

Applications: Rim: 6100ED(F), 6200ED
SquareBolt®: 6150ED(F), 6250ED
SVR: 6170ED(F), 6210ED
CVR: 6160ED(F), 6220ED
Mortise: 6130ED(F)

Ordering: Suffix "S" to the Model Number. Ex: 6150EDS.

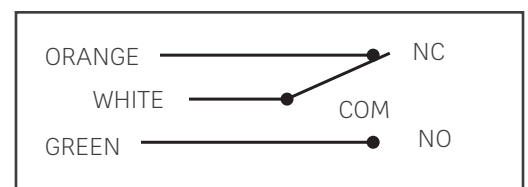

Electrified System Guide (B, O, S)

Components

- 6100EDBOS – PB627F Nightlatch Trim – Yale®
- S Bolt Position Monitor Switch
- B Pushpad Monitor Switch
- O Trim Monitor Switch
- Door Position Switch – Securitron®
- QC12 Power Transfer Hinge by McKinney®
- Surface Door Closer – Yale®

Operation

Operation of the 6100ED Exit Device with the B, O, S and ASSW-104A can be used together or individually to sound an alarm, shunt an alarm, monitor the door's security or as a "Request to Exit" in conjunction a magnetic lock.

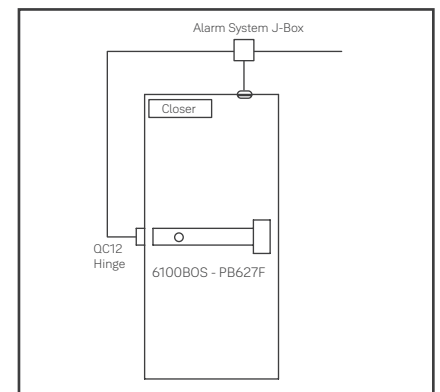

Electrified Options



Alarm Kit "A" / "A-ALR"

Activation: Alarm is armed by turning key clockwise. Low audible chirp indicates alarm has been activated. Alarm will sound when the exit device pushpad is depressed. Factory preset for standard alarm mode which automatically resets after 5 minutes.

Continuous Alarm Mode: Alarm sounds continuous when the exit device pushpad is depressed. Alarm must be manually reset by keyswitch. (This feature is selected by a switch on the circuit board.)

Low Battery Warning: Audible chirp.

Nuisance Alarm: Factory preset for instant alarm. Selectable feature for alarm to sound when pushpad is depressed for more than 2 seconds. (This feature is selected by a switch on the circuit board.)

Arming Delay/Authorized Egress: 10-second delay (after arming) permitting egress (by turning key clockwise).

Alarm Shunt: Ingress shunt alarm input for devices with latchbolt position (S) monitor. NOTE: "S" included with SVR devices.

Power Requirements: One 9-Volt Battery (included).

Loudness: 90db @ 10 feet.

Arm/Disarm: Uses one 1-1/8" straight cam mortise cylinder. Clockwise turn arms the alarm, counter clockwise turn disarms or silences the alarm.

Device Status: A Red LED indicator will illuminate every 30 seconds when the alarm is armed.

Tamper Resistant: Built-in safety monitor sounds alarm when tampering occurs.

Warning: "A" supplied with "EMERGENCY EXIT - ALARM WILL SOUND" decal
"A-ALR" supplied with red screenprinted pushpad (available in 622 black finish only)



6100ED-A-ALR

Applications: Rim: 6100ED(F), 6200ED; SquareBolt®: 6150ED(F), 6250ED; SVR: 6170ED(F), 6210ED; CVR: 6160ED(F), 6220ED; Mortise: 6130ED(F)

Kit: Available in kit form for field retrofit.

Bar Length: Available for 36"-48" devices only. May not be used on bars less than 36".

- Standard 36" device fits doors 35"-36" Device cannot be cut less than 35".
- Option -48 fits doors 41"-48". Devices cannot be cut less than 41".
- A-ALR option only available in 36" length

How to Order: Specify 6116 for alarm kit. Suffix "-A" when ordering with device. Ex: 6100ED-A-ALR x 36 x 622.

NOTE: The 6116 alarm kit cannot be retrofitted in the field to the 6170ED(F), 6210ED or 6210ED(F) surface vertical rod exit devices. This option is available as a factory order only for these devices. Any attempt to retrofit the 6116 alarm kit with these surface vertical rod exit devices will void the warranties for these products.

Mortise Device Trim Control "Safe/ Secure"

Operation

Allows the outside trim to lock or unlock electrically from a remote location. Exit device allows free egress at all times.

Fail Safe devices are commonly used in stair towers or locations that require the trim to unlock when power is removed or during fire alarm activation.

Fail Secure devices are used to secure openings and are usually integrated into the building security system to allow access control. Fail Secure trims remain locked when power is removed.

Electrical Specifications

Solenoid

- .35 amps @ 24VDC only (12 volt not available)
- Continuous duty
- Requires a 2-wire pivot or hinge and a standard 24VDC regulated and filtered power source (Recommended BPS power supplies)

Listings

UL/cUL listed for panic and fire exit hardware.

Applications

Mortise: 6130ED(F)

Ordering

"Safe" – Maintains the outside trim in a locked state when energized. Removal of power unlocks outside trim.
"Secure" – Unlocks the outside trim when energized. Remains locked when power is removed.

Suffix "SAFE" or "SECURE" to the Model Number.
Ex: 6130ED x L5 x Safe.



Electrified Options

Electric Trim

The electrified 600 Series heavy-duty trim provides electric locking and unlocking of trim. Ideal for door control where increased security is necessary at all times, while meeting life safety codes. Electric trim is ideal for many applications, including stairwell towers, high-security areas, schools, hospitals, and factories.

Functions

690F Trim - Fail Safe

- Lever is locked when power is on (Free-Wheeling)
- Power off allows entry from trim
- Inside device is always active for egress
- Mechanical key override (09 Function – Key allows lever to retract latchbolt. Key can only be removed in locked position)

691F Trim - Fail Secure

- Lever is locked when power is off (Free-Wheeling)
- Power on allows lever activation for entry
- Inside device is always active for egress
- Mechanical key override (09 Function – Key allows lever to retract latchbolt. Key can only be removed in locked position.)

Features

- Accepts all standard and Reflections® decorative lever designs
- Plug connector with 4' wire lead (Exit device is used as wire raceway, not door)
- Key Override – Requires rim cylinder (sold separately)



Applications

- 6100ED(F) Rim Device
- 6150ED(F) SquareBolt®
- 6170ED(F) Surface Vertical Rod

Electrical Specifications

- 330 mA @ 24 Volts
SM – Security Monitor Switch
- 4 AMP @ 250VAC
Voltage: 24 VAC/VDC only
BPS Series power supplies recommended.

Options

- SM - Security Monitor. A SPDT switch that monitors the position of the solenoid (lock and unlock status).
- EX - Trim gasket for exterior applications.

Electrified System Guide

For use with:

- 691F Electrified Trim – Yale®
- 6100ED Rim Exit Device – Yale®
- Digital Keypad by Securitron®
- QC8 Power Transfer Hinge by McKinney®
- BPS Power Supply

Operation

Operation of the Digital Keypad will allow keyless entry from the non-protected side of the opening. When a valid code is entered into the keypad, voltage will be applied to the trim, making the lever active and allowing ingress. Free exit is allowed by using the exit device from the protected side of the door.

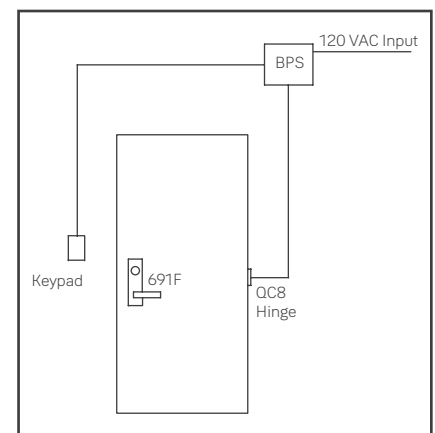

Electrified Options



Stand-Alone Door Alarm SDA 16

The stand-alone battery operated door alarm is designed to continually monitor the status of a door. When the door is opened without authorization, an alarm is triggered to alert the security violation. This alarm features a piezo horn which blasts a deafening 105+ decibels to alert the violation.



This unit is ideal for emergency doors as well as stairwell doors and rear exit doors in retail environments. The unit, which can also be hardwired, easily complements existing hardware, making any opening alarmed. The SDA16 door alarm is typically mounted on the interior of the door frame or door and is paired with a magnet mounted on the opposing side of the door gap.

Features

- Dimensions: 8.3"L x 3.1"W x 2.0"D (210mm L x 79mm W x 52mm D)
- Non-handed unit (field reversible)
- Unit powered by 9V battery
- Unit can be hardwired by using WH-11 wire harness and 784 power supply
- No battery is required in unit with hard-wire option – if power is lost, optional gel-cell battery in power supply will give approximately 10,000 operations
- Reverse battery protection safeguards the unit if the battery is incorrectly installed
- A low-voltage battery is indicated by an audible signal every 30 seconds
- Piezo horn blasts at 105+ decibels if the door is used with out proper authorization
- The LED will flash every 30 seconds, indicating either the unit is armed or, if under auto reset, that the door has been violated
- Various field-adjustable features by dip switch including automatic alarm reset, REX and passage time delay, and LED color preference
- A tamper switch provides instantaneous signal to sound horn in the event the cover is removed. Horn will sound until the unit is reset by the key or remote reset/arm switch
- Conformally coated electronics for weather resistance
- Cover is held in place by cam lock which protects mounting screws, electrical system and internal sensors
- Accepts external cylinder (not included, must be specified)
- Accepts standard mortise cylinders (not included, must be specified)

Remote Mounting

The SDA16 can be installed remotely from the door by attaching the contacts to the door and frame. The unit can be installed up to 6 feet from the door. This provides the ideal solution for circumstances where exposure to weather may be an issue. To order specify "SDA16XL".

Cylinders and Accessories

- 784 Power supply (9VDC) – includes plug-in wall transformer
- Plug-in wall transformer with 12' cable assembly (part no. 00-0000-3425)
- Gel-cell battery – optional for use with 784 power supply (part no. 00-0000-3426)
- WH-11 Wire harness for remote power and remote unlock
- Mortise cylinder for unit
- Rim cylinder for outside control
- See pages 40-43 for cylinder information.

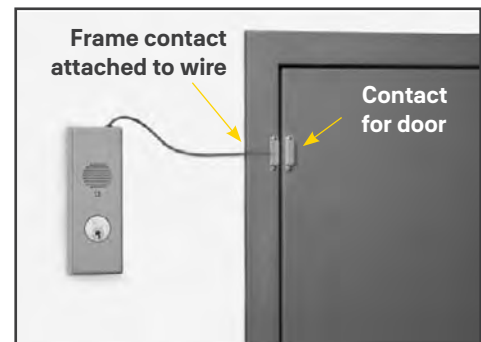

Note: Actual wire length is 6 feet.



Electrified Options

782 Power Control

Operation

Designed to control one or two electric latch retraction "P" exit devices. Equipped with two 20-second timers which can operate the exit devices together or independently. Requires a momentary or timed, dry contact input and can be interfaced with access control systems, automatic door operators, hands-free actuation devices, "blow open" type scenarios and has provisions for N/C fire alarm systems.

Note: The 782 is required for use with the "P" latch retraction option. Using any other power supply with the "P" option voids the warranty of the device.

Features

- Two control inputs. Accepts normally closed dry contacts for device activation from a key switch, push button, access control or fire alarm system.
- Two normally open control outputs for automatic door operators
- Two "P" device outputs
- Fire Alarm Interface input
- 24VDC output for audible or LEDES .25 AMP



Electrical Specifications

- 120 VAC 60Hz 750mA (max.)
- 38-42 VDC output
- 10 amp inrush

Listings

- UL 294
- UL CLASS 2 outputs

Applications

"P" Electric Latch Retraction Option

Ordering

782 Controller

BPS Power Supplies By Securitron®

Operation

Power supplies are designed to provide reliable filtered and regulated power for long life to a variety of electrified hardware components.

Product Features

- Individual output circuit breakers
- Regulated and filtered fuse protected outputs
- LEDs monitor zone status (voltage or no voltage)
- Slide switches connect or disconnect load from power (Not available on 1 Amp supplies)
- Internal Back-Up battery charging circuit
- Rugged steel enclosure
- Fire alarm interface

Listings

- UL CLASS 2

Applications (use with):

- G – Electric Dogging
- Safe – Fail Safe mortise device trim control
- Secure – Fail Secure mortise device trim control
- 690/691 – Electric Trim

Ordering

Ex: BPS-24-4

Model	Input	Output	Application
BPS-24-1	120 VAC	1 Amp @ 24 VDC	1 "D"
BPS-24-2	120 VAC	2 Amp @ 24 VDC	2 "D" or 1 "D" with Safe or Secure
BPS-24-4	120 VAC	4 Amp @ 24 VDC	4 "D" or 3 "D" with Safe or Secure

Consult factory for additional power supply applications.

Yale recommends McKinney®, Pemko and Securitron® for power transfer devices and other electronic accessories.

Functions



Single Cylinder Functions

SquareBolt® 6150ED(F) 6250D		Rim 6100ED(F) 6200ED		Surface Vertical Rod 6170ED(F) 6210ED		Concealed Vertical Rod 6160ED(F) 6220ED		Mortise 6130ED(F)		Function	ANSI Function No.	Function Description
Inside	Outside	Inside	Outside	Inside	Outside	Inside	Outside	Inside	Outside			
										Exit Only	01	Exit only, no trim.
										Dummy	02	Entrance by trim when actuating bar is locked down.
										Nightlatch	03	Entrance by trim when latchbolt is retracted by key. Key removable only when locked.
										Classroom	08	Entrance by lever. Key locks or unlocks knob or lever.
										Storeroom	09	Entrance by lever only when released by key. Key removable only when locked.
										Passage	14	Entrance by trim when latchbolt is released by lever. Lever always active, no cylinder.

Note: 09 and Free-Wheeling 02 achieved with a single modification at installation.

Double Cylinder Functions

SquareBolt® 6150ED(F)-2		Rim 6100ED(F)-2		Mortise 6130ED(F)-2		Function	ANSI Function No.	Function Description
Inside	Outside	Inside	Outside	Inside	Outside			
						Classroom	08	Entrance by lever. Key either side locks or unlocks lever.

Functions



Thumbpiece, Thumbturn And Pull Trim Functions

SquareBolt® 6150ED(F) 6250ED		Rim 6100ED(F) 6200ED		Surface Vertical Rod 6170ED(F) 6210ED		Concealed Vertical Rod 6160ED(F) 6220ED		Mortise 6130ED(F)		Function	ANSI Function No.	Function Description
Inside	Outside	Inside	Outside	Inside	Outside	Inside	Outside	Inside	Outside			
										Exit Only	01	Exit only, no trim.
										Dummy	02	Entrance by trim when actuating bar is locked down.
										Nightlatch	03	Entrance by trim when latchbolt is retracted by key. Key removable only when locked.
										Classroom	05	Entrance by thumbpiece. Key locks or unlocks thumbpiece.
										Storeroom	06	Entrance by thumbpiece only when released by key. Key removable only when locked.
										Passage	15	Entrance by trim when latch is released by thumbpiece. Thumbpiece is always active, no cylinder.

Note: 06 achieved with a single modification at installation.

Applications & Listings



Performance Standards

UL - cUL Panic Exit Listing: Doors up to 4'0" x 10'0"* (1.22m x 3.05m), single swing or pairs.

UL - cUL Fire Exit Label: Doors up to 4'0" x 10'0" (1.22m x 2.44m), single swing or pairs.

*UL does not set height limitations on panic devices.

Complies with NFPA80 for fire exit hardware

Complies with NFPA101 for life safety

Meets requirements for ADA



Listing Agency	Listing Number		
	Panic Exit Devices	Fire Exit Devices	Latching Hardware
Underwriters Laboratories, Inc.	(FVSR)	(GXHX)	(ZHEM)
California Fire Marshal	4140-0257: 111	3625-0257: 112	
New York City		MEA: 477-91-E MEA: 333-05-M	
ANSI/BHMA	A156.3 (Directory of Certified Exit Devices)		

Note: Any retrofit or other field modification to a fire rated opening can potentially impact the fire rating of the opening, and Yale Locks & Hardware makes no representations or warranties concerning what such impact may be in any specific situation. When retrofitting any portion of an existing fire rated opening, or specifying and installing a new fire-rated opening, please consult with a code specialist or local code official (Authority Having Jurisdiction) to ensure compliance with all applicable codes and ratings.

Applications & Listings



6100ED Series Wide Stile Applications

Single Door	UL Listing	Maximum Opening	Application	
SquareBolt®				
6150ED/6150ED-2	Panic	4' x *	Surface applied; single-point latching.	
6150ED(F)/6150ED(F)-2	3 Hr.	4' x 8'		
Rim				
6100ED/6100ED-2	Panic	4' x *	Surface applied; single-point latching.	
6100ED(F)/6100ED(F)-2	3 Hr.	4' x 8'		
Mortise				
6130ED/6130ED-2	Panic	4' x *	Mortised in door; single-point latching.	
6130ED(F)/6130ED(F)-2	1-1/2 Hr.	4' x 9'		
6130ED(F)/6130ED(F)-2	3 Hr.	4' x 8'		
Surface Vertical Rod				
6170ED	Panic	4' x 10'	Surface applied; two-point latching.	
6170ED x LBR	Panic	4' x 10'	Surface applied; one-point latching.	
Concealed Vertical Rod				
6160ED	Panic	4' x 10'	Rods concealed in door; two-point latching.	
6160ED x LBR	Panic	4' x 10'	Rods concealed in door; one-point latching.	

*UL does not set a door height limitation on panic applications.

Pair of Doors with Removable Mullion	UL Listing	Maximum Opening	Application	
SquareBolt® x SquareBolt®				
6150ED x 6150ED x M200 Series	Panic	8' x 10'	Two independent active doors with removable mullion.	
6150ED(F) x 6150ED(F) x M200F Series	3 Hr.	8' x 8'		
Rim x Rim				
6100ED x 6100ED x M200 Series	Panic	8' x 10'	Two independent active doors with removable mullion.	
6100ED(F) x 6100ED(F) x M200F Series	3 Hr.	8' x 8'		

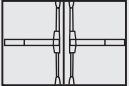
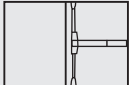
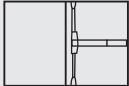
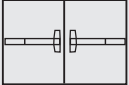
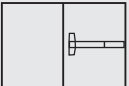

6100ED Series Wide Stile Applications

Pair of Doors	UL Listing	Maximum Opening	Application	
Surface Vertical Rod				
6170ED x 6170ED	Panic	8' x 10'	Two independent doors with two-point latching, swinging in the same direction.	
6170ED(F)90 x 6170ED(F)90	1-1/2 Hr.	8' x 10'		
6170ED(F) x 6170ED(F)	3 Hr.	8' x 8'		
6170ED x 6170ED x LBR	Panic	8' x 10'	Two independent doors with one-point latching, swinging in the same direction.	
6170ED(F)90 x 6170ED(F)90 x LBR	1-1/2 Hr.	8' x 10'		
Surface Vertical Rod (Double Egress)				
6170ED x 6170ED	Panic	8' x 10'	Two independent doors with two-point latching, swinging in opposite directions. Overlapping astragal not required.	
6170ED(F)90 x 6170ED(F)90	1-1/2 Hr.	8' x 10'		
6170ED(F) x 6170ED(F)	3 Hr.	8' x 8'		
6170ED x 6170ED x LBR	Panic	8' x 10'	Two independent doors with one-point latching, swinging in opposite directions. Overlapping astragal not required.	
6170ED(F)90 x 6170ED(F)90 x LBR	1-1/2 Hr.	8' x 10'		
Surface Vertical Rod x Mortise				
6170ED x 6130ED	Panic	8' x 10'	Overlapping astragal required for fire-rated openings. Coordinator required with standard ANSI strike.	
6170ED(F)90 x 6130ED(F)	1-1/2 Hr.	8' x 9'		
Concealed Vertical Rod				
6160ED x 6160ED	Panic	8' x 10'	Two independent metal or wood doors with two-point latching, swinging in the same direction.	
6160ED(F)90 x 6160ED(F)90	1-1/2 Hr.	8' x 10'		
6160ED(F) x 6160ED(F)	3 Hr.	8' x 8'		
6160ED x 6160ED x LBR	Panic	8' x 10'	Two independent metal or wood doors with one point latching, swinging in the same direction.	
6160ED(F)90 x 6160ED(F)90 x LBR	1-1/2 Hr.	8' x 10'		
Concealed Vertical Rod (Double Egress)				
6160ED x 6160ED	Panic	8' x 10'	Two independent metal or wood doors with two-point latching, swinging in opposite directions. Overlapping astragal not required.	
6160ED(F)90 x 6160ED(F)90	1-1/2 Hr.	8' x 10'		
6160ED(F) x 6160ED(F)	3 Hr.	8' x 8'		
6160ED x 6160ED x LBR	Panic	8' x 10'	Two independent metal or wood doors with one-point latching, swinging in opposite directions. Overlapping astragal not required.	
6160ED(F)90 x 6160ED(F)90 x LBR	1-1/2 Hr.	8' x 10'		

Applications & Listings



6200ED Series Narrow Stile Applications

Single Door	UL Listing	Maximum Opening	Application
SquareBolt*			
6250ED	Panic	4' x *	Surface applied; single-point latching.
Rim			
6200ED	Panic	4' x *	Surface applied; single-point latching.
Surface Vertical Rod			
6210ED	Panic	4' x 10'	Surface applied; two-point latching.
Concealed Vertical Rod			
6220ED	Panic	4' x 10'	Rods concealed in door; two-point latching.
Pair of Doors			
Surface Vertical Rod			
6210D x 6210ED	Panic	8' x 10'	Two independent doors with two-point latching, swinging in the same direction.
Surface Vertical Rod (Double Egress)			
6210ED x 6210ED	Panic	8' x 10'	Two independent doors with two-point latching, swinging in opposite directions.
Concealed Vertical Rod			
6220ED x 6220ED	Panic	8' x 10'	Two independent metal doors with two-point latching, swinging in the same direction.
Concealed Vertical Rod (Double Egress)			
6220ED x 6220ED	Panic	8' x 10'	Two independent metal doors with two-point latching, swinging in opposite directions.
Pair of Doors with Removable Mullion			
SquareBolt* x SquareBolt*			
6250ED x 6250ED x M300	Panic	8' x 10'	Two independent active doors with removable mullion.
Rim x Rim			
6200ED x 6200ED x M300	Panic	8' x 10'	Two independent active doors with removable mullion.

*UL does not set a door height limitation on panic applications.

Cylinders



Rim

The following chart details rim cylinders for use with 420F, 480F, 500F, 620F, 630F, 121NL trims and outside of SDA16 door alarm:

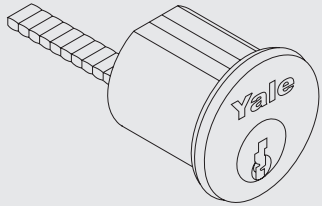
				Collar Requirements*						
Model #	Description	Pins	Length	420F	480F/ 500F	620F	630F	121NL	SDA16 Outside	
1109	Standard Fixed Core	6	1-1/4"	599.419	599.419	No Collar	No Collar	1765.250	1765.250	
1109	Standard Fixed Core	7	1-7/16"				1765.438			
1709	CMK	6	1-15/16"	599.544	599.544	1765.250	1765.250			
1709	CMK	7	1-5/8"	599.700	599.700		1765.406			
1193	LFIC Complete	6	1-7/16"	599.544	599.544		1765.250			
1193	LFIC Complete	7	1-5/8"	599.700	599.700	1765.344	1765.406			
5109	Security Fixed Core	6	1-9/16"	599.419	599.419	No Collar	1765.250			
5109	Security Fixed Core	7	1-7/16"							
U5109	High Security Fixed Core	6	1"	NA	NA	No Collar	No Collar			No Collar
U5109	High Security Fixed Core	7	1"							
5193	Security LFIC Complete	6	1-7/16"	599.544	599.544	1765.250	1765.250	1765.250	1765.250	
5193	Security LFIC Complete	7	1-5/8"	599.700	599.700	1765.344	1765.406			
K300	Yale® KeyMark® Standard Fixed Core	6	1-1/8"	599.544	599.544	KP4	1765.250			
K300	Yale® KeyMark® Standard Fixed Core	7								
K840/ K880	Yale® KeyMark® LFIC Complete / Housing Only	6	1-7/16"	599.700	599.700	1765.406	1765.500			
K840/ K880	Yale® KeyMark® LFIC Complete / Housing Only	7	1-5/8"	NA	NA	1765.563	1765.619			
K640/ K680	Yale® KeyMark® SFIC Complete / Housing Only	6	1-1/4"	599.544	599.544	KP4	1765.250			
K640/ K680	Yale® KeyMark® SFIC Complete / Housing Only	6 or 7	1-3/8"	599.700	599.700	1765.187	1765.406			
A640/ K680	Best® Keyway SFIC Complete / Housing Only	6	1-1/4"	599.544	599.544	KP4	1765.250			
A640/ K680	Best® Keyway SFIC Complete / Housing Only	6 or 7	1-3/8"	599.700	599.700	1765.187	1765.406			
2109	Schlage® "C" Keyway Fixed Core Available 0-bitted or keyed random.	6	1-1/8"	599.419	599.419	No Collar	No Collar			

*Based on 1-3/4" door thickness. Collar length required must be specified for cylinders and/or housings ordered separately.

LFIC = Large Format Interchangeable Core

SFIC = Small Format Interchangeable Core

NA = Application Not Available

Cylinders



Mortise

The following chart details mortise cylinders for use with 650F, 660F, 670F trims, cylinder dogging, and 6116 alarms:

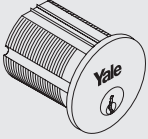
				650F		660F/670F		Cylinder Dogging/ 6116 Alarm			
Model #	Description	Pins	Length	Cam	Collar	Cam	Collar	Cam	Collar		
2153	Standard Fixed Core	6	1-1/4"	2160	NA	2160	NA	2160	1765.156		
2153	Standard Fixed Core	6	1-1/2"		No Collar		KP4		NA		
2153	Standard Fixed Core	7	1-1/4"		NA		NA		1765.156		
2153	Standard Fixed Core	7	1-1/2"		No Collar		KP4		NA		
2196	LFIC Complete	6	1-1/2"		KP4		1765.250		1765.406		
2197	LFIC Complete	7	1-11/16"		NA		NA		1765.594		
5153	Security Fixed Core	6	1-1/8"		No Collar		KP4		No Collar		
5153	Security Fixed Core	6	1-1/2"		NA		NA		NA		
5153	Security Fixed Core	7	1-1/4"		NA		NA		1765.156		
5153	Security Fixed Core	7	1-1/2"		No Collar		KP4				
U5153	High Security Fixed Core	6	1-1/8"		NA		NA		NA		
U5153	High Security Fixed Core	7	1-1/4"		No Collar		KP4		1765.406		
5196	Security LFIC Complete	6	1-1/2"		KP4		1765.250		1765.594		
5197	Security LFIC Complete	7	1-11/16"								
K100	Yale® KeyMark® Standard Fixed Core	6 or 7	1-1/8"		KC1		NA		KC1	KC1	No Collar
K100	Yale® KeyMark® Standard Fixed Core	6 or 7	1-1/2"				No Collar				KP4
K100	Yale® KeyMark® Standard Fixed Core	6 or 7	1-3/4"	Riveted		KP4	Riveted	1765.375			NA
K820/ K860	Yale® KeyMark® LFIC Complete / Housing Only	6	1-1/2"	KC1	No Collar	KC1	KC1	KP4	1765.406		
K820/ K860	Yale® KeyMark® LFIC Complete / Housing Only	7	1-11/16"		KP4			1765.375	1765.594		
K620/ K660	Yale® KeyMark® SFIC Complete / Housing Only	6	1-1/4"		NA			NA	1765.156		
K620/ K660	Yale® KeyMark® SFIC Complete / Housing Only	6 or 7	1-3/8"		No Collar				1765.281		
K620/ K660	Yale® KeyMark® SFIC Complete / Housing Only	6 or 7	1-3/4"	Riveted	KP4	Riveted	1765.375	NA	NA		
A620/ K660	Best® Keyway SFIC Complete / Housing Only	6	1-1/4"	KC1	NA	KC1	KC1	NA	1765.156		
A620/ K660	Best® Keyway SFIC Complete / Housing Only	6 or 7	1-3/8"					No Collar		1765.281	
A620/ K660	Best® Keyway SFIC Complete / Housing Only	6 or 7	1-3/4"	Riveted	KP4	Riveted	1765.375	NA	NA		
2553	Schlage® "C" Keyway Fixed Core. Available 0-bitted or keyed random.	6	1-1/8"	NA	NA	2160	NA	2160	No Collar		

See legend notes on following page.

Cylinders



Mortise

The following chart details mortise cylinders for use with inside of SDA16 door alarm and KRM200 standard mullions

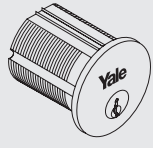
				SDA16 Inside		KRM200 (Standard)	
				Cam	Collar	Cam	Collar
Model #	Description	Pins	Length				
2153	Standard Fixed Core	6	1-1/8"	2160	No Collar	2160	1765.312
2153	Standard Fixed Core	7	1-1/4"		No Collar		1765.500
2196	LFIC Complete	6	1-1/2"		KP4		1765.750
2197	LFIC Complete	7	1-11/16"		1765.250		1765.844
5153	Security Fixed Core	6	1-1/8"		No Collar		1765.312
5153	Security Fixed Core	7	1-1/4"		No Collar		1765.500
U5153	High Security Fixed Core	6	NA		NA		NA
U5153	High Security Fixed Core	7	NA		NA		NA
5196	Security LFIC Complete	6	1-1/2"		KP4		1765.750
5197	Security LFIC Complete	7	1-11/16"		1765.250		1765.844
K100	Yale® KeyMark® Standard Fixed Core	6 or 7	1-1/8"	KC1	No Collar	KC1	1765.312
K820/K860	Yale® KeyMark® LFIC Complete / Housing Only	6	1-1/2"		KP4		1765.750
K820/K860	Yale® KeyMark® LFIC Complete / Housing Only	7	1-11/16"		1765.250		1765.000
K620/K660	Yale® KeyMark® SFIC Complete / Housing Only	6	1-1/4"		No Collar		1765.500
K620/K660	Yale® KeyMark® SFIC Complete / Housing Only	6 or 7	1-3/8"		No Collar		1765.563
A620/K660	Best® Keyway SFIC Complete / Housing Only	6	1-1/4"		No Collar		1765.500
A620/K660	Best® Keyway SFIC Complete / Housing Only	6 or 7	1-3/8"		No Collar		1765.563
2553	Schlage® "C" Keyway Fixed Core. Available 0-bitted or keyed random.	6	1-1/8"		2160		No Collar

Based on 1-3/4" door thickness. Collar length required must be specified for cylinders and/or housings ordered separately.

LFIC = Large Format Interchangeable Core.

SFIC = Small Format Interchangeable Core.

NA = Application Not Available

Cylinders



Component



Model #	Description	Pins
1802	Standard Lever Fixed Core	6
1802A	Standard Lever Fixed Core	7
5802	Security Lever Fixed Core	6
5802A	Security Lever Fixed Core	7
1210	LFIC Only	6
1220	LFIC Only	7
5210	Security LFIC Only	6
5220	Security LFIC Only	7
K402	Yale® KeyMark® Lever Fixed Core	6 or 7
K800	Yale® KeyMark® LFIC Only	6 or 7
K600	Yale® KeyMark® SFIC Only	6 or 7
A600	Best® Keyway SFIC Only	6 or 7
2802	Schlage® "C" Keyway Fixed Core. Available 0-bitted or keyed random.	6
3804*	Corbin Russwin "L4", Corbin "60", Russwin "D1", Sargent® "LA" or Schlage® "E" Keyway Fixed Core. Specify keyway. Available keyed random	6
107S	Adaptor kit for Schlage cylinder	—

*Requires the 107S kit. These cylinders are not ANSI/BHMA certified.

Collars & Tailpieces



Cylinder Collars

If required, cylinder collar size must be specified.

<p>1765 Recessed Cylinder Collar "A" Dimension: Thicknesses from 1/16" (2mm) to 1-15/32" (37mm) as required. Material: Brass, Bronze</p>	<p>KP3 Wave Washer (Furnished standard with 1765 collar for Yale® KeyMark® cylinders and 630F series trim).</p>	<p>599 Recessed Cylinder Collar with Radius "A" Dimension: Thicknesses from 1/16" (2mm) to 1-15/32" (37mm) as required. Material: Brass, Bronze</p>	<p>KP4 Flush Mount Cylinder Collar Material: Brass, Bronze</p>

Long Tailpiece Kit

Door Thickness	Trim Type	Part Number
2" - 2-1/2"	620F and 630F Series Trim	81-9500-1665-000
2-1/2" - 3-1/2"	620F and 630F Series Trim	81-9500-1635-000
3-1/2" - 4-1/2"	620F and 630F Series Trim	81-9500-1636-000

Specify part number to order.

Von Duprin® Tailpiece

This tailpiece is available for the Yale® 1109 rim cylinder to operate the night latch function for Von Duprin exit devices. To order, specify model number: 1145VD.



Strikes



Rim Devices

<p>757F Standard strike for 6100ED(F), 6150ED(F) devices. Supplied with #10-24 x 3/4" machine screws, two shims (each 1/16" thick), and one locking plate.</p>	<p>759 Standard strike for 6200ED, 6250ED devices.</p>	<p>793 Optional strike for 6100ED, 6150ED exit devices on double door applications without a mullion. Supplied with #10-24 x 3/4" machine screws, two shims (each 1/16" thick), and one locking plate. Panic only.</p>

Mortise Devices

<p>798 Standard curved lip ANSI strike used with 7130(F) devices. (1-1/4" lip)</p>	<p>61/712 Optional flat lip ANSI strike used with 7130 devices for pairs of doors with astragals. (7/8" lip)</p>	<p>618/718 Optional open back strike. Permits opening of the inactive door for pairs of doors where approved by door manufacturer.</p>	<p>202 Optional strike box for ANSI strikes. 7/8" (22mm) deep.</p>

Vertical Rod Devices - Top Strikes

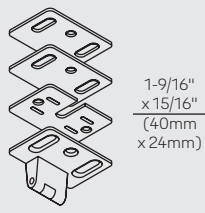
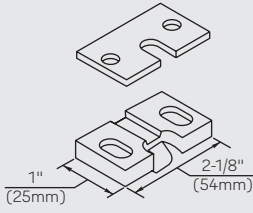
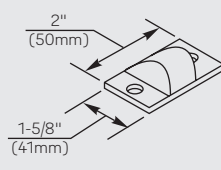
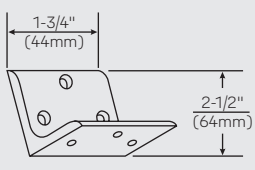
 <p>1-9/16" x 15/16" (40mm x 24mm)</p>	 <p>1" (25mm) 2-1/8" (54mm)</p>	 <p>2" (50mm) 1-5/8" (41mm)</p>	 <p>1-3/4" (44mm) 2-1/2" (64mm)</p>
<p>791 Standard top strike for 7110(F), 7120(F), 7210, 7220, 7210M(F), 7220M(F) series devices. Supplied with #10-24 x 3/4" machine screws, two shims (each 1/16" thick), and one locking plate.</p>	<p>726 Standard top strike for 7170(F) series devices. Supplied with #12-24 x 11/16" machine screws and #12 x 1-1/4" sheet metal screws, and one shim (1/16" thick).</p>	<p>761 Standard top strike for 7160(F) series devices. Supplied with #10-32 x 3/8" machine screws and #10 x 1" sheet metal screws.</p>	<p>797 Optional bracket for mounting 791 top strike in flush transom opening. Supplied with 1/4-20 machine screws; SN-134 sex nuts, optional.</p>

Vertical Rod Devices - Bottom Strikes

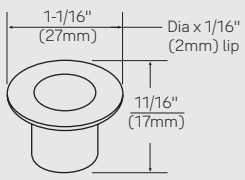
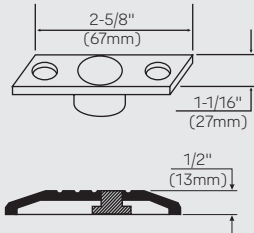
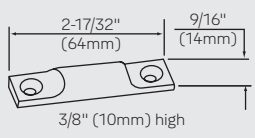
 <p>1-1/16" (27mm) Dia x 1/16" (2mm) lip 11/16" (17mm)</p>	 <p>2-5/8" (67mm) 1-1/16" (27mm) 1/2" (13mm)</p>	 <p>2-17/32" (64mm) 9/16" (14mm) 3/8" (10mm) high</p>
<p>790 Standard bottom strike for 7110(F), 7120(F), 7160(F), 7170(F), 7210, 7220, 7210M(F), 7220M(F) series devices. Press in place.</p>	<p>794 Optional bottom strike for fire openings using saddle thresholds or for flush floor mount. Must use for fire openings with 1/2" thresholds. Supplied with #10-24 x 1/2" machine screws and floor anchors.</p>	<p>702 Optional bottom strike for bottom pullman latch option. Supplied with #8 x 8/32" combination screws.</p>



Accessories/Options

620DB Dummy Pushbar

For push-pull vestibule doors leading to doors with 6000ED Series exit devices. Bars fit doors up to 48" (122cm) wide. Same finishes as devices. Specify 620 x finish. Not available with Microshield®.

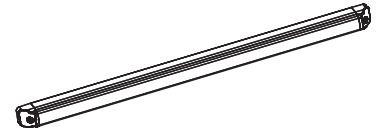

Anti-Pry Bracket

The anti-pry bracket offers end users increased security by improving resistance against jamb spreading during a pry attack. When the door is in the closed position, the anti-pry bracket interlocks in position between the exit device strike and frame preventing the strike and exit device latch from being separated. For use with all 6100ED(F) rim and 6150ED(F) SquareBolt® devices. Kit includes interlock bracket and end cap shim, the standard exit device mounting screws can be used, therefore, no additional fasteners are required. Black powder coat finish. To order specify option/model number: 625AP

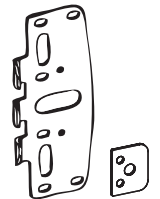

Bottom Pullman Latch

Optional bottom pullman latch available for panic listed vertical rod exit devices. To order with devices, specify "BPL." 702 bottom strike required, see page 46.

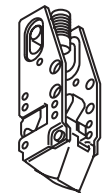

Cylinder Dogging

All Yale 6000ED exits come standard with hex key wrench for dogging. As an option, cylinder dogging is also available on non-fire rated devices.

Cylinder dogging is available for panic-listed exit devices only. Requires use of 1-1/8" mortise cylinder. When ordered with a device, cylinder must be ordered separately. (See How to Order, "Fourth Digit", page 7.) Cylinder dogging kit available; specify 615 and size (24", 36", 36" NS, 42", 42" NS, 48", 48" NS). Cylinder not included with this kit.

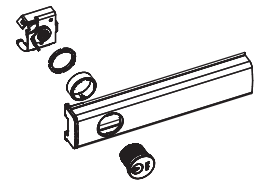

Note: NS = Narrow stile

Double Cylinder Functions

Available on wide stile rim, SquareBolt and mortise devices, key on either side locks or unlocks lever. Specify using -2 suffix.

Extension Rods

Model #	Length
7010-2	2" (51mm)
7010-6	6" (152mm)
7010-12	12" (305mm)
7010-24	24" (610mm)

Specify finish.



Plastic Installation Template

Provided as a standard with all 6000ED Series exit device, the plastic installation template facilitates door markings over traditional paper templates. This provides a more accurate door prep which reduces installation mistakes and overall installation time. Template dimensions: 8-1/4" x 3-1/4" (210mm x 83mm). To order separately, specify part number: 60-6000-9100-999.



Schlage® Cam Assembly

This cam and housing assembly includes a cam engineered to accept Schlage rim cylinders. No modifications are required to existing 500 and 600 Series exit device trims thus maintaining the trim's classroom and storeroom functions. To order, specify part number: 60-6000-0815.

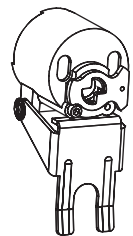

Shim Kits

Shim kits, for devices on doors with interfering molding, are available. Each standard shim kit contains 2 sets of 1/8" thick shims to shim a device 1/8" (3mm) or 1/4" (6mm). Longer device mounting screws (not included) are required for more than 1/4" (6mm) shimming. 693 (Black) finish.

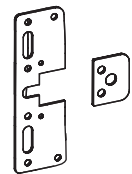

623SK	Shim kit for 6100ED(F) Series rim, 6150ED(F) Series Squarebolt®, 6160ED(F) Series* concealed vertical rod, and 6130ED(F) Series* mortise exit devices.
623NS	Shim kit for 6200ED Series rim, 6250ED series Squarebolt and 6220ED Series* concealed vertical rod exit devices.
624SK	Shim kit for 6170ED(F) Series surface vertical rod exit devices.
624NS	Shim kit for 6210ED Series narrow stile surface vertical rod exit devices

*Note: Special mortise or concealed vertical rod components needed for openings requiring more than (2) shim kits, or for shimmed mortise devices in doors over 1-3/4" (44mm) thick. Details on application.

Specialty Fasteners

Sex Nuts:

Required for wood, composite or unreinforced metal doors.

- SN-104 – Interlock bracket pack of (4) 10-24 sex nuts for all fire rim and Squarebolt® devices.
- SN-134 – pack of (4) 1/4-20 sex nuts for all devices.

TORX® Security Screws:

Available for factory product orders. Wood screws may only be used in predrilled pilot holes of solid core wood doors.

Mullions

M200(F) Removable Mullion

M200(F) steel mullions are for use with 6100(F) Series wide stile exit devices. Mullions may be field cut to fit opening. Red primer finish.

- M200 panic rated.
Tubular steel, 2" x 3" (51mm x 76mm). Specify 7', 8', or 10'.
- M200F 3 hour fire rated.
Tubular steel, 2" x 3" (51mm x 76mm). Specify 7' or 8'.

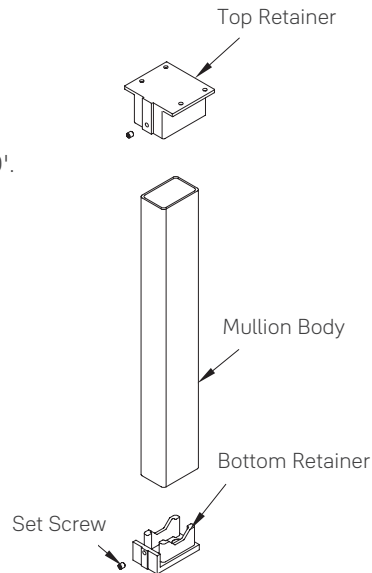

M200(F)

M300 Removable Mullion

M300 mullions are for use with 6200ED Series narrow stile exit devices. They consist of an aluminum extrusion 1-1/4" x 3" (32mm x 76mm), with built-in strikes for device bolts. Supplied with mounting brackets, mechanical fasteners, and mullion stabilizers. Available finishes are 628 (Satin, clear anodized) and 695 (dark amber coat). Specify 8' or 10'. For 9' mullion, specify 10' and cut to size in field.

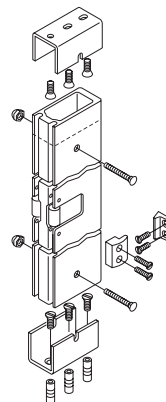

M300

102S Mullion Stabilizer Kit

Recommended for high openings and whenever door movement must be further restricted. Supplied standard with M300 mullions. To order separately, specify 102S.

Mullions



KRM200(F) Keyed Removable Mullion (KRM)

Keyed removable mullions are for use with 6100ED(F) Series wide stile exit devices. They are designed for simple removing when an unobstructed large opening is required and easy replacement and locking to maintain the integrity of the opening.

- Easy cylinder installation.
- Mullion automatically relocks when reinstalled without the use of the cylinder key.
- When ordering, add KR prefix to mullion, example: KRM200 and KRM200F.
- KRM200 panic rated. Specify 7', 8', or 10'.
- KRM200F 1-1/2 hour fire rated. Specify 7' or 8'.

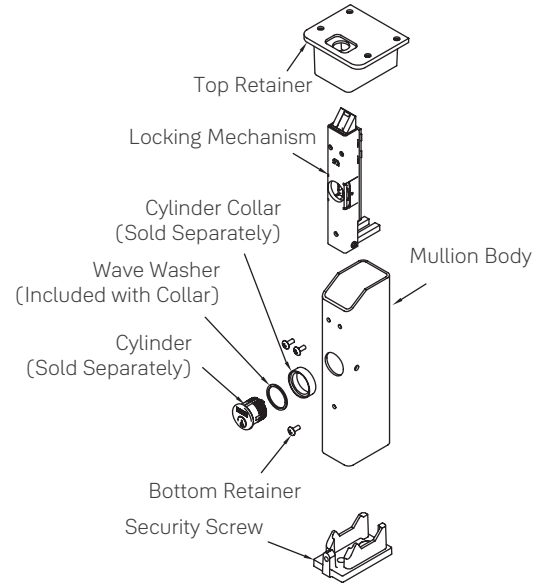

KRM200(F)

M200(F) And KRM Options

- **M203 Spacer Block**
Recommended for double rabbeted frames where the stop face width is less than the mounting hole spacing or for applications with 5-3/4" (146mm) or less door frames.
- **M204 Angle Bracket**
Recommended for any header configuration with less than 3" (76mm) of mounting surface.

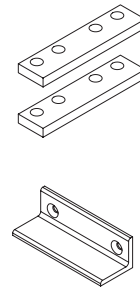

KRM Cylinders

As with any exit device trim, you must order a cylinder and collar if one is required. The Yale® keyed removable mullion accepts a mortise cylinder. Refer to page 41-42 for details.



Dimensions

Device

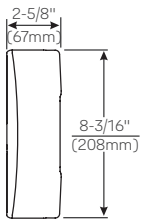

Cover Detail

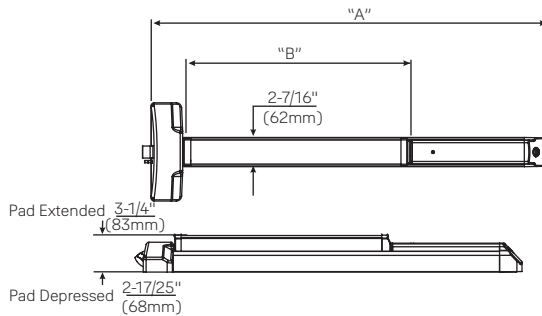

6100 Series (all models)

Series	"A"	"B"
6100ED-36	33"	18-5/8"
6100ED(F)-36	(838mm)	(473mm)
6100ED-42	39"	21-5/8"
6100ED(F)-42	(990mm)	(549mm)
6100ED-48	44-5/8"	24-5/8"
6100ED(F)-48	(1133mm)	(625mm)

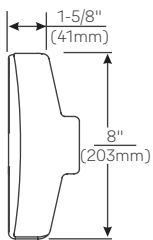

Cover Detail

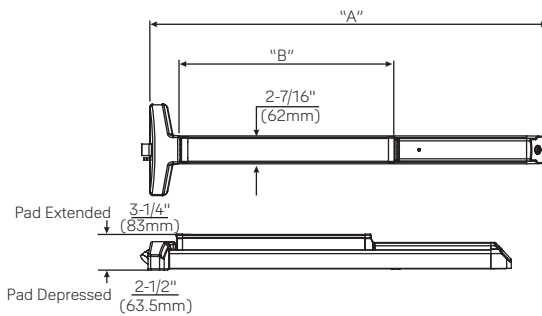

6200 Series (all models)

Series	"A"	"B"
6200ED-36	34-3/4"	18-5/8"
	(883mm)	(473mm)
6200ED-42	40-3/4"	21-5/8"
	(1035mm)	(549mm)
6200ED-48	46-3/4"	24-5/8"
	(1187mm)	(625mm)

Trim

620F/650F Series	630F/660F Series	500F Series	480F Series
Projection: 13/16" (20mm)	Projection: 2-3/4" (70mm)	Projection: 1/4" (6mm)	Projection: 2-7/8" (73mm)

Lever/Rose

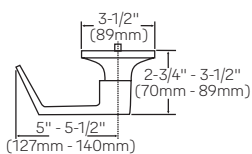

Sample Specifications



Specification

Exit devices shall be 6000ED Series Pushpad Exit Devices as manufactured by Yale Locks & Hardware.

The exit device chassis shall be cold forged steel, electroplated for corrosion resistance, and shall be architecturally finished brass, bronze or stainless steel. The pushpad mechanism shall be constructed of extruded aluminum and shall be scalped with architecturally finished brass, bronze or stainless steel. The maximum projection shall be 3-1/4" when the pushpad is active and 2-3/4" when the pushpad is dogged down. Nylon bearings and stainless steel springs shall be used for long life and durability; only torsion springs are acceptable. Rear and active case covers shall be wrought brass or bronze and shall be plated to match the exit bar. Plastic or painted covers are not acceptable. Latchbolts shall be steel and shall incorporate a deadlocking latch for increased security. Devices without deadlocking latches are not acceptable. Mounting screws shall be concealed to deter tampering. Devices shall be closed on all sides with no pinch points. Exit devices shall be easily field sized to accommodate various door widths.

Panic-listed exit devices shall have single point, one quarter turn hex key dogging standard. Optional cylinder dogging shall be available on panic listed devices. Devices with hex key dogging shall be easily field converted to cylinder dogging. Panic listed devices shall be available less dogging.

Trims shall be throughbolted with concealed fasteners. Escutcheon and pull-type trims shall be constructed of brass or bronze. All lever trims shall use cast or forged levers. On rim, SquareBolt® and vertical rod trims with cylinders, the mechanism that locks and unlocks the trim shall be housed in the trim and not in the active case of the exit device. Lever trims (except mortise) shall be Free-Wheeling with clutch mechanism allowing lever to rotate 60° when locked for ideal protection. Lever trims shall match those on Yale® mortise and cylindrical locksets.

Exit devices and trims shall be furnished in ANSI/BHMA standard architectural finishes.

Exit devices shall be listed by Underwriters Laboratories (UL) for safety as panic hardware. Fire-rated devices shall be listed for A label and lesser class doors.

Certification:

ANSI/BHMA A156.3, Grade 1

Devices, trims and cylinders shall be from one manufacturer.

Devices and 400F, 500F, and 600F trims shall carry a ten-year limited warranty.

690F/691F trims shall carry a two-year limited warranty.

Electric options and components shall carry a two-year limited warranty.





Trusted every day

Phone

1-855-557-5078

Customer Service Email

customerservice.yale@assaabloy.com

Technical Product Support Email

techsupport.yale@assaabloy.com

Order Entry Email

orders.yaleus@assaabloy.com

Fax

1-800-338-0965

Website

www.yalecommercial.com

Contact Us

U.S.A.

Yale Locks & Hardware

Address: 225 Episcopal Road

Berlin, CT 06037-4004

Tel: 1-800-438-1951

Fax: 1-800-338-0965

yalecommercial.com

Canada:

ASSA ABLOY Door Security Solutions Canada

Address: 160 Four Valley Drive

Vaughan, Ontario L4K 4T9

Tel: 1-800-461-3007

Fax: 1-800-461-8989

assaabloydss.ca

International:

ASSA ABLOY Americas International

Tel: 1-905-821-7775

Fax: 1-905-821-1429

assaabloyai.com

MicroShield®

ASSA ABLOY Group companies offer MicroShield®, an anti-microbial coating for door hardware. MicroShield uses proven silver ion-based technology from Agion®, a leading provider of antimicrobial solutions, to stem the spread of bacteria and other microbes.

MicroShield® is a registered trademark of ASSA ABLOY Access and Egress Hardware Group, Inc.



The Agion antimicrobial is not intended as a substitute for good hygiene. Coated products must still be cleaned to ensure the surfaces will be free of destructive microbes. ASSA ABLOY makes no representations or warranties, express or implied, as to the efficacy of the Agion antimicrobial. A copy of the Agion warranty is available upon request. Agion is a registered trademark of Agion Technologies, Inc., Wakefield, MA, USA.

THE YALE BRAND, with its unparalleled global reach and range of products, reassures more people in more countries than any other consumer locking solution.

THE ASSA ABLOY GROUP is the world's leading manufacturer and supplier of locking solutions, dedicated to satisfying end-user needs for security, safety and convenience.

Yale Commercial is a business associated with ASSA ABLOY Access and Egress Hardware Group, Inc., an ASSA ABLOY Group company. Copyright © 2002-2020, ASSA ABLOY Access and Egress Hardware Group, Inc. All rights reserved. Reproduction in whole or in part without the express written permission of ASSA ABLOY Access and Egress Hardware Group, Inc. is prohibited. Patent pending and/or patent www.assaabloydss.com/patents.



2100 Series Economy Exit Devices





Table of Contents

Contents

Introduction.....	3
Benefits & Features.....	4
Finishes.....	5
How to Order.....	6
2100(F) Rim.....	7
2150(F) SquareBolt®.....	8
2110(F) Surface Vertical Rod.....	9
2170(F) Surface Vertical Rod.....	10
2120(F) Concealed Vertical Rod.....	11
2160(F) Concealed Vertical Rod.....	12
Trim Designs.....	13-20
Functions.....	21
Applications.....	22-23
Electrified Options.....	24
Cylinders.....	25-28
Collars & Tailpieces.....	28
Strikes.....	29
Accessories & Options.....	30
Mullions.....	31-32
Dimensions.....	33
Sample Specification.....	34
Technical Specifications & Listings.....	35

2100 Economy Exit Devices

With a combination of sturdy construction and innovative security features, it's easy to see why building owners and architects alike prefer the 2100 Series Exit Device for all their economy applications. The quality and certified ANSI/BHMA Grade 1 performance ensures strength and reliability wherever this device is installed. Available in a wide range of both standard and architectural finishes, the 2100 Series is a perfect fit for both back of house and prominent openings in office buildings, retail and a long list of other facilities that require both performance and style.





Balancing function with aesthetics in every application, Yale Works for YouSM.

Introduction

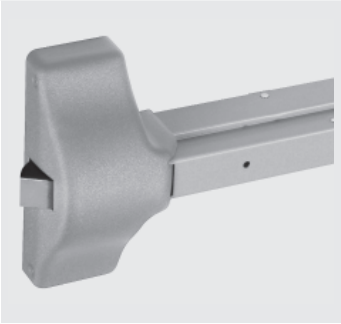

Yale® Commercial Solutions offers innovative and reliable products to solve the challenges of commercial, retail, hospitality, assisted living, mixed-use, and multi-family properties. With over 150 years of door hardware experience, Yale's expertise extends beyond products to people - and provides the service and support you expect.

Featuring durable products to meet all your facilities' requirements - and the quality you expect from a leader in the hardware industry. Yale Works for YouSM.

Yale Exit Devices			
7000 Series	6000 Series	1800 Series	1500 Series
			
<ul style="list-style-type: none"> • Ideal for facilities that require durability and innovation to meet their security needs • Wide & Narrow Stile Applications • Rim, SquareBolt, Mortise, SVR & CVR • Mechanical & Electro-Mechanical Functions • Available with Motorized Electric Latch Retraction • Constructed with high quality steel and heavy-duty components • 16 Standard finishes including BSP (Black Suede Powder Coat) • UL Rated for Panic & Fire • ANSI/BHMA Certified Grade 1 • 5 Year Warranty and Two-Year Limited Warranty on Electronic Components • UL Rated for Panic & Fire, Windstorm Rated Options (refer to local codes) 	<ul style="list-style-type: none"> • Ideal for facilities that require modern form and full functionality to meet their life safety needs • Wide & Narrow Stile Applications • Rim, Squarebolt, CVR, SVR & Mortise • Mechanical & Electro-Mechanical Functions • Aluminum rail assembly with Architectural Metals • Solid Cast Flush End Cap • ANSI/BHMA Certified Grade 1 • UL Rated for Panic & Fire • 10 Year Warranty 	<ul style="list-style-type: none"> • Ideal for back of the house where function and code compliance are the requirement • Wide Stile Applications • Rim & SVR • Mechanical Functions • ANSI/BHMA Certified Grade 1 • UL Rated for Panic & Fire • Powder-coat Painted Finishes • 1 Year Warranty 	<ul style="list-style-type: none"> • Ideal for renovation projects where historical preservation is the desired look • Wide Stile Applications • Rim, CVR, SVR & Mortise • ANSI/BHMA Certified Grade 1 • UL Rated for Panic & Fire • Architectural & Painted Finishes • 1 Year Warranty

Benefits & Features



Benefits

- **Tough:** Sturdy construction is ideal for meeting the rigors of demanding industry environments
- **Versatile:** Available in standard painted as well as architectural finishes for both front and back of house applications
- **Economical:** Works for many building projects, regardless of budget
- **Strong & Durable:** ANSI/BHMA Grade 1 Certification ensures long life and reliability









Features

- High-grade steel components offer superior protection against wear & tear
- Available in a variety of functions and finishes for any application
- Offered in Yale's innovative SquareBolt® latchbolt
- ANSI/BHMA Grade 1 certified 
- UL/cUL listed for panic and fire rated doors
- Windstorm certified devices available
- Three year warranty

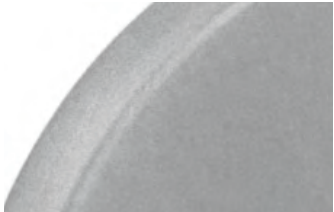

Finishes



ANSI/BHMA Code Finish Description			
613E Dark Oxidized Satin Bronze - equivalent	630* Satin Stainless Steel	689 Aluminum Painted	691 Light Bronze Painted
			
693 Black Painted	695 Dark Bronze Painted	BSP Black Suede Powder Coat	WSP White Suede Powder Coat
			

*Finish available with MicroShield® antimicrobial coating, additional finishes by special application. Consult factory for availability.

MicroShield coating may vary finish color from architectural standards. MicroShield is not intended as a substitute for traditional infection control programs such as hand hygiene or use of disinfectants. Coated products must still be cleaned to ensure the surfaces will be free of destructive microbes. Yale makes no representations or warranties, express or implied, as to the efficacy of MicroShield.

How to Order



2	1	X	0	Suffix	-XX	Outside Trim	Finish	Other Info
		Third Digit: "0" - Rim Device, Pullman Latch "1" - SVR Device "2" - CVR Device "5" - SquareBolt® Rim Security "6" - CVR Device "7" - SVR Device	Fourth Digit: "0" - Standard	No Suffix - Panic label "F" - Fire exit device "WS" - Windstorm Certified Products (see notes 4, 5, 6)	Size: (DOW=Door Opening Width) "36" - 30" - 36" (0.76m to 0.91m) DOW "42" - 36" to 42" (0.91m to 1.07m) DOW "48" - 42" to 48" (1.07m to 1.22m) DOW	Trim Model Number See pages 13-20	613E 630 689 691 693 695 BSP WSP	Door Hand - RHR or LHR (vertical rod devices or lever escutcheon trim only). Rim devices are field reversible. SN-134, 1/4-20 Sex Nuts (pack of 4). SN-104, 10-24 Sex Nuts (pack of 4). Door thickness: over 1-3/4" (45mm). Rod Extensions: (quantity) 2010-2 (quantity) 2010-6 (quantity) 2010-12 (quantity) 2010-24 Shim Kits: (quantity) 223 (quantity) 224 Optional Strike Bottom Pullman Latch Removable Mullion: M200, Panic Exit M200F, Fire Exit KRM200, Panic Exit KRM200F, Fire Exit Custom Cylinder & Cylinder Collar Factory Keying

Notes:

1. It is recommended that exit devices and trim for the same opening be ordered together.
2. Standard product is for 1-3/4" (44mm) reinforced metal doors.
3. Accessories detached from the device and trim should be specified separately.
4. "WS" applies only to 2100(F) devices.
5. Maximum opening size 3'0" x 7'0".
6. Contact Ceco, Curries® or Fleming for detailed frame/door requirements and limitations.

Ordering Examples

Exit Device Only

6150D-36 x 626 x RHR x SNB

Exit Device with Trim and Cylinder*

6170F90-9-48 x AU626F x 605 x LHR x 1109 GA 0-bit

Trim Only

MO656F x 630 x RHR x LC

Double Cylinder Exit Device with Trim

6150F-2-36 x AU626F x 630

2100(F) Rim



The 2100(F) is a rim exit device to be used with single doors or pairs of doors constructed of metal, wood or composite materials. The 2100(F) can be paired with a wide variety of trims to meet many applications.

Certification/Compliance

UL/cUL Listed: FVSR/FVSR7 - Panic hardware
GXHX/GXHX7 - Fire exit hardware (F)
(4' x 8' single, 8' x 8' pairs, 3 hr.)
ZHEM - Latching hardware
ZHLA - Windstorm rated assemblies



Features

- Designed for wide stile doors
- Non-handed for easy installation
- Steel interlock "E" bracket maintains door-to-mullion relationship in fire-labeled devices
- Deadlocking pullman latchbolt positively engages roller strike
- Available certified hurricane resistant (refer to local codes). Specify 2100(F)WS.  Hurricane

Applications

- Single swing doors
- Pairs of doors (mullion required)
- Metal, wood or composite door materials

Specifications

Door Opening Width	-36 for 30" - 36" (76cm - 91cm) doors -42 for 36" - 42" (91cm - 107cm) doors -48 for 42" - 48" (107cm - 122cm) doors
Door Thickness	1-3/4" (44mm) standard. Optional door thicknesses available to 4-1/2"; specify door thickness when ordering.
Minimum Stile Width	4-1/2" (114mm)
Projection	2-1/2" (64mm) active, 1-3/4" (44mm) depressed
Latchbolt	3/4" (19mm) deadlocking stainless steel pullman-type
Strike	757F, 793 optional (double door application, panic only)
Fasteners	Machine screws and wood door fasteners standard for panic hardware. Sex nuts and bolts supplied standard for fire exit hardware.
Trims	121NL cylinder only, 210F series utility trim, 440F series rose trim, 580F series rose trim with escutcheon plate, 620F series escutcheon trim, 630F series pull/thumbpiece trim. See pages 13-20.
ANSI/BHMA	Certified: A156.3 Type 1, Grade 1
Dogging	Hex key dogging supplied standard on panic devices
Finishes	613E, 630, 689, 691, 693, 695, BSP
Options	Shim kit #223, sex nuts and bolts, MicroShield®
Warranty	3-year limited



2150(F) SquareBolt®



Just as easy to open as traditional latchbolts, the SquareBolt® exit device's unique construction offers innovative protection. The SquareBolt's design presents an improved physical barrier over standard rim latchbolts. The SquareBolt exit device locks into place and stays there. Credit cards, crowbars, door rattling and shaking are resisted, significantly reducing the threat of unauthorized entry.



Certification/Compliance

UL/cUL Listed: FVSR/FVSR7 - Panic hardware
 GXHX/GXHX7 - Fire exit hardware (F)
 (4' x 8' single, 8' x 8' pairs, 3 hr.)

U.S. Patent #: 5,605,362

Features

- SquareBolt security deadbolt designed for maximum holding power
- Designed for wide stile doors
- Non-handed for easy installation
- Steel interlock "E" bracket maintains door-to-mullion relationship in fire-labeled devices

Applications

- Single swing doors
- Pairs of doors (mullion required)
- Metal, wood or composite door materials

Specifications

Door Opening Width	-36 for 30" - 36" (76cm - 91cm) doors -42 for 36" - 42" (91cm - 107cm) doors -48 for 42" - 48" (107cm - 122cm) doors
Door Thickness	1-3/4" (44mm) standard. Optional door thicknesses available to 4-1/2"; specify door thickness when ordering.
Minimum Stile Width	4-1/2" (114mm)
Projection	2-1/2" (64mm) active, 1-3/4" (44mm) depressed
Deadbolt	1" (25mm) slide projection bolt with full 3/4" (19mm) projection
Strike	757F, 793 optional (double door application, panic only)
Fasteners	Machine screws and wood door fasteners standard for panic hardware. Sex nuts and bolts supplied standard for fire exit hardware.
Trims	121NL cylinder only, 210F series utility trim, 440F series rose trim, 580F series rose trim with escutcheon plate, 620F series escutcheon trim, 630F series pull/thumbpiece trim. See pages 13-20.
ANSI/BHMA	Certified: A156.3 Type 1 or 28, Grade 1
Dogging	Hex key dogging supplied standard on panic devices
Finishes	613E, 630, 689, 691, 693, 695, BSP
Options	Shim kit #223, sex nuts and bolts, MicroShield®
Warranty	3-year limited

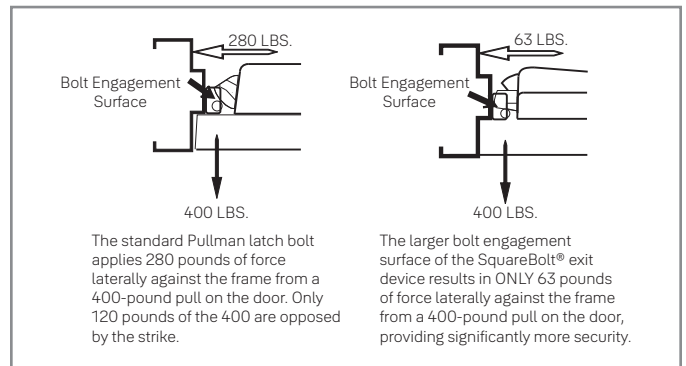



2110(F) Surface Vertical Rod

The 2110(F) is a surface vertical rod exit device to be used on metal, wood or composite pairs of doors up to 8' (fire) and 10' (panic) where two-point latching is desired.

Certification/Compliance

UL/cUL Listed: FVSR/FVSR7 - Panic hardware
GXHX/GXHX7 - Fire exit hardware (F)
(8' x 8' pairs, 3 hr.)

Features

- Designed for wide stile doors
- Handed, specify hand (field reversible)
- Positive action linkage on a deadlocking top pullman bolt
- Simultaneous direct pull bottom deadbolt
- When unlatched, device keeps both bolts retracted until door is shut

Applications

- Pairs of doors
- Double egress
- Metal, wood or composite door materials



Specifications

Door Opening Width	-36 for 30" - 36" (76cm - 91cm) doors -42 for 36" - 42" (91cm - 107cm) doors -48 for 42" - 48" (107cm - 122cm) doors
Door Opening Height	Standard door height 7' (213cm), with the device centerline at 39-15/16" (101cm) from floor. Optional heights up to 8' (fire) and 10' (panic) available by using rod extensions. For fire rated openings over 8', see 2170F SVR.
Door Thickness	1-3/4" (44mm) standard. Optional door thicknesses available to 4-1/2"; specify door thickness when ordering.
Minimum Stile Width	4-1/2" (114mm)
Projection	2-1/2" (64mm) active, 1-3/4" (44mm) depressed
Latchbolt	Top: 3/4" (19mm) throw, pullman-type with automatic deadlatching. Bottom: 5/8" (16mm) throw deadbolt, held retracted during door swing.
Vertical Rods	1/2" (13mm) O.D. tubular brass, bronze or stainless steel with rod guides
Strike	Top: Roller type 791. Bottom: Flush mounted 790. 794 floor strike optional (threshold openings).
Fasteners	Machine screws and wood door fasteners standard for panic hardware. Sex nuts and bolts supplied standard for fire exit hardware.
Trims	210F series utility trim, 440F series rose trim, 580F series rose trim with escutcheon plate, 620F series escutcheon trim, 630F series pull/thumbpiece trim. See pages 13-20.
ANSI/BHMA	Certified A156.3 Type 2, Grade 1
Dogging	Hex key dogging supplied standard on panic devices
Finishes	613E, 630, 689, 691, 693, 695, BSP
Options	Shim kit #224, sex nuts and bolts, bottom pullman latch (panic only), MicroShield®
Warranty	3-year limited



2170(F) Surface Vertical Rod



The 2170(F) is a surface vertical rod exit device to be used on wide stile and flush doors up to 10' where one or two-point latching is desired. A Less Bottom Rod (LBR) option is available.

Certification/Compliance

UL/cUL Listed: FVSR/FVSR7 - Panic hardware
 GXHX/GXHX7 - Fire exit hardware (F) (8' x 10' pairs, 1-1/2 hr.) (8' x 8' pairs, 3 hr.)

Features

- Designed for wide stile and flush doors
- Mechanisms made of heavily electroplated high-grade steel and non-ferrous materials provide sturdy construction and superior protection against corrosion
- Interlocking top strike and latch mounting plate for added stability
- Handed, specify hand (field reversible)
- Available less bottom rod (LBR option)

Applications

- Pairs of doors
- Double egress
- Metal, wood, or composite door materials

Specifications

Door Opening Width	-36 for 30" - 36" (76cm - 91cm) doors -42 for 36" - 42" (91cm - 107cm) doors -48 for 42" - 48" (107cm - 122cm) doors
Door Opening Height	Standard door height 7' (213cm), with the device centerline at 39-15/16" (101cm) from floor. Optional heights specify suffix -8, -9, -10.
Door Thickness	1-3/4" (44mm) standard. Optional door thicknesses available to 4-1/2"; specify door thickness when ordering.
Minimum Stile Width	4-1/2" (114mm)
Projection	2-1/2" (64mm) active, 1-3/4" (44mm) depressed
Latchbolt	Top: 3/4" (19mm) throw, pullman-type with automatic deadlatching. Bottom: 5/8" (16mm) throw deadbolt, held retracted during door swing.
Vertical Rods	1/2" (13mm) O.D. tubular brass, bronze or stainless steel with rod guides
Strike	Top: 726. Bottom: Flush-mounted 790. 794 floor strike optional (threshold openings).
Fasteners	Machine screws and wood door fasteners standard for panic hardware. Sex nuts and bolts supplied standard for fire exit hardware.
Trims	210F series utility trim, 440F series rose trim, 580F series rose trim with escutcheon plate, 620F series escutcheon trim, 630F series pull/thumbpiece trim. See pages 13-20.
ANSI/BHMA	Certified A156.3 Type 2, Grade 1
Dogging	Hex key dogging supplied standard on panic devices
Finishes	613E, 630, 689, 691, 693, 695, BSP
Options	Shim kit #223, sex nuts and bolts, bottom pullman latch (panic only), less bottom rod (LBR), -8, -9, -10 opening height, rod extensions, MicroShield®
Warranty	3-year limited





2120(F) Concealed Vertical Rod

The 2120(F) is a concealed vertical rod exit device to be used on metal doors only up to 8' (fire) and 10' (panic) where two-point latching is desired.

Certification/Compliance

UL/cUL Listed: FVSR/FVSR7 - Panic hardware
GXHX/GXHX7 - Fire exit hardware (F)
(8' x 8' pairs, 3 hr.)

Features

- Designed for wide stile doors
- Handed, specify hand (field reversible)
- Positive action linkage on a deadlocking top pullman bolt
- Simultaneous direct pull bottom deadbolt
- When unlatched, device keeps both bolts retracted until door is shut

Applications

- Pairs of doors
- Double egress
- Metal doors only



Specifications

Door Opening Width	-36 for 30" - 36" (76cm - 91cm) doors -42 for 36" - 42" (91cm - 107cm) doors -48 for 42" - 48" (107cm - 122cm) doors
Door Opening Height	Standard door height adjustable to 8' (244cm), with the device centerline at 39-15/16" (101cm) from floor. Optional heights up to 10' (panic) available by using rod extensions. For fire rated openings over 8', see 2160F CVR.
Door Thickness	1-3/4" (44mm) standard. 2" and 2-1/4" (51mm and 57mm) optional; specify when ordering.
Minimum Stile Width	4-1/2" (114mm)
Projection	2-1/2" (64mm) active, 1-3/4" (44mm) depressed
Latchbolt	Top: 3/4" (19mm) throw, pullman-type with automatic deadlatching Bottom: 5/8" (16mm) throw deadbolt, held retracted during door swing
Vertical Rods	1/2" (13mm) O.D. telescoping tubular rods
Strike	Top: Roller type 791. Bottom: Flush mounted 790. 794 floor strike optional (threshold openings).
Fasteners	Machine screws standard for panic hardware. Sex nuts and bolts supplied standard for fire exit hardware.
Trims	210F series utility trim, 440F series rose trim, 580F series rose trim with escutcheon plate, 620F series escutcheon trim, 630F series pull/thumbpiece trim. See pages 13-20.
ANSI/BHMA	Certified A156.3 Grade 1, Type 8, Grade 1
Dogging	Hex key dogging supplied standard on panic devices
Finishes	613E, 630, 689, 691, 693, 695, BSP
Options	Shim kit #223, sex nuts and bolts, bottom pullman latch (panic only), MicroShield®
Warranty	3-year limited



2160(F) Concealed Vertical Rod

The 2160(F) is a concealed vertical rod exit device to be used on wood and metal doors up to 10' where one or two-point latching is desired. A Less Bottom Rod (LBR) option is available.

Certification/Compliance

UL/cUL Listed: FVSR/FVSR7 - Panic hardware
 GXHX/GXHX7 - Fire exit hardware (F) (8' x 10' pairs, 1-1/2 hr.) (8' x 8' pairs, 3 hr.)

Features

- Designed for wide stile and flush doors
- Mechanisms made of heavily electroplated high-grade steel and non-ferrous materials provide sturdy construction and superior protection against corrosion
- Handed, specify hand (field reversible)
- Available less bottom rod (LBR option)

Applications

- Pairs of doors
- Double egress
- Metal, wood, or composite door materials

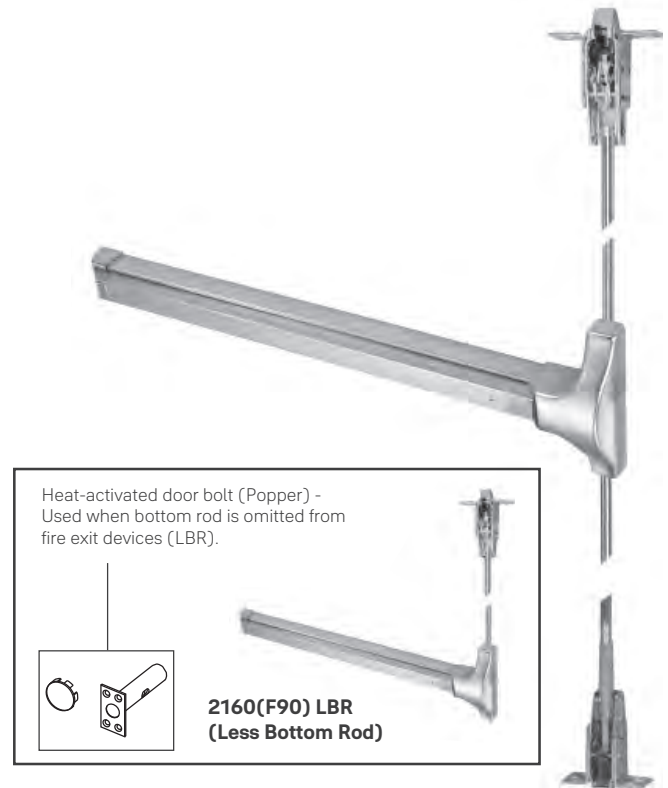





Specifications

Door Opening Width	-36 for 30" - 36" (76cm - 91cm) doors -42 for 36" - 42" (91cm - 107cm) doors -48 for 42" - 48" (107cm - 122cm) doors
Door Opening Height	Standard door height adjustable to 8' (244cm), with the device centerline at 39-15/16" (101cm) from floor. Optional heights specify suffix -9, -10.
Door Thickness	1-3/4" (44mm) standard. 2" and 2-1/4" (51mm and 57mm) optional; specify when ordering.
Minimum Stile Width	4-1/2" (114mm)
Projection	2-1/2" (64mm) active, 1-3/4" (44mm) depressed
Latchbolt	Top: 3/4" (19mm) throw, pullman-type with automatic deadlatching Bottom: 5/8" (16mm) throw deadbolt, held retracted during door swing
Vertical Rods	1/2" (13mm) O.D. telescoping tubular rods
Strike	Top: Mortised 761. Bottom: Flush-mounted 790. 794 floor strike optional (threshold openings).
Fasteners	Machine screws and wood door fasteners standard for panic hardware. Sex nuts and bolts supplied standard for fire exit hardware.
Trims	210F series utility trim, 440F series rose trim, 580F series rose trim with escutcheon plate, 620F series escutcheon trim, 630F series pull/thumbpiece trim. See pages13-20.
ANSI/BHMA	Certified A156.3 Type 7 and 8, Grade 1
Dogging	Hex key dogging supplied standard on panic devices
Finishes	613E, 630, 689, 691, 693, 695, BSP
Options	Shim kit #223, sex nuts and bolts, bottom pullman latch (panic only), less bottom rod (LBR), -9, -10 opening height, rod extensions, MicroShield®
Warranty	3-year limited



Trim Designs



















Escutcheons

480F Series	580F Series	620F Series	630F/660F/670F Series
			
Projection: 2-13/32" (61mm)	Projection: see levers	Projection: see levers	Projection: 2-1/8" (54mm)

Roses

440F Series	540F Series
	
Projection: 3-1/2" (89mm)	Projection: 3-1/2" (89mm)

Standard Escutcheon Trim

Arcadia AR 	Augusta AU 	Carmel CR 	Jefferson JN 
			
Projection: 3-1/4" (82mm)	Projection: 2-5/8" (61mm)	Projection: 3-1/8" (79mm)	Projection: 2-9/16" (65mm)
Monroe MO 	Pacific Beach PB 	Pinehurst PN 	Virginia VI 
			
Projection: 3" (76mm)	Projection: 3-5/16" (84mm)	Projection: 3-1/16" (78mm)	Projection: 3-1/8" (79mm)

















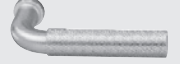















Note: Projection dimensions are provided using the 620F series escutcheon plates.

Trim Designs



Reflections® Levers



Hudson	TB  Projection 3-1/16" (78mm)	UB  Projection 3-1/4" (83mm)	TC  Projection 3" (76mm)	TD  Projection 3-7/16" (87mm)	UC  Projection 3-7/16" (87mm)	
Spree	RS  Projection 3-1/8" (79mm)	RT  Projection 3-1/8" (79mm)	RU  Projection 3-13/32" (87mm)	RV  Projection 3" (76mm)		
Seine	TE  Projection 3" (76mm)	TG  Projection 2-13/16" (61mm)	TI  Projection 3-3/8" (85mm)	TO  Projection 3-1/2" (89mm)	TJ  Projection 3-1/16" (78mm)	TK  Projection 3-1/4" (83mm)
Thames	TM  Projection 3-1/16" (78mm)	TN  Projection 3-1/16" (78mm)	TP  Projection 3-5/16" (84mm)	TR  Projection 3-1/16" (78mm)	TS  Projection 3-1/8" (80mm)	TQ  Projection 3-1/16" (78mm)
Victoria	TT  Projection 2-11/16" (68mm)	TU  Projection 3-1/4" (83mm)	TV  Projection 3-1/2" (89mm)	TW  Projection 3" (76mm)	UW  Projection 3-7/16" (87mm)	TX  Projection 3-5/8" (92mm)
Victoria, continued	UX  Projection 3-7/16" (87mm)	TY  Projection 3-5/16" (84mm)	TZ  Projection 3-7/16" (87mm)			
Niagara	MA  Projection 2-13/16" (71mm)	RA  Projection 3-11/16" (94mm)	RB  Projection 2-13/16" (71mm)	RC  Projection 2-13/16" (71mm)		

Note: Projection dimensions are provided using the 620F Series escutcheon plates.

Note: The following Reflections levers are not available in 629 or 630 finish: Victoria TT, TU, TV, TW, TX, TY, UW, UX, TZ; Seine TG, TJ, TK, TO, TE, TI. Please consider the 618 or 619 finish as an alternative. Reflections levers are not available with knurling option.

Trim Designs



620F Series Wide Escutcheon Trim



- Certified ANSI/BHMA A156.3, Grade 1.
- Trim through-bolts to exit device for strength.
- Beveled sides improve attack resistance.
- Solid forged/cast escutcheon and free-wheeling trim for ideal protection.
- Flush cylinder in 6-pin applications for additional security.
- 1-3/4" (44mm) door standard. For doors through 2-1/4" (57mm) or shim-mounted devices, specify on order.
- Dimensions: 3" x 10-1/4" x 13/16" (76mm x 260mm x 19mm).
- Cylinders not included. See page 25-27 for cylinder options.
- Available with AR, AU, CR, JN, MO, PB, PN, VI, HA lever designs. See page 13.
 - Finishes: 613E, 626, 630, 693, BSP
- Available with Reflections® lever designs. See page 14.
 - Finishes: 613E, 626, 630, BSP
- Trim ordering example: AU626F x 626 x RHR.
- 5-year limited warranty.

Application	Cylinder	Classroom/ Storeroom Cylinder Controls Thumbturn	Exit Only Blank Plate	Nightlatch Access by Key	Classroom Cylinder Controls Lever	Storeroom Cylinder Controls Lever	Nightlatch Cylinder by Lever	Passage	Dummy Trim Free- Wheeling	Dummy Rigid Lever
2100(F) 2150(F) 2110(F) 2120(F) 2160(F) 2170(F)	Rim	603F ¹	620F	621F ²	626F	626F ¹	627F ²	628F	628F ¹	629F
ANSI		11/12	01	03	08	09	03	14	02	02

¹ 09, 12 and Free Wheeling 02 achieved with single trim modification at installation.

² Not recommended for use with vertical rod exit devices.

For 626 & 630 finishes the escutcheon and standard levers are plated to simulate stainless steel.

Optional door thickness available up to 4-1/2", specify on order.

Trim Designs



630F Series Wide Pull/Thumbpiece Trim



- Certified ANSI/BHMA A156.3, Grade 1.
- Trim through-bolts to exit device for strength.
- Beveled sides improve attack resistance.
- Flush cylinder in 6-pin applications for additional security.
- 1-3/4" (44mm) door standard. For doors through 2-1/4" (57mm) or shim-mounted devices, specify on order.
- Plate Dimensions: 2-3/4" x 15-1/2" x 5/8" (70mm x 394mm x 16mm).
- Pull Dimensions: 6-7/16" (164mm) on centers x 2-1/8" (54mm) projection.
- Cylinders not included. See pages 25-27 for cylinder options.
- Finishes: 613E, 626, 630, 693, BSP
- Trim ordering example: 630F x 630
- 5-year limited warranty.

Applications	Cylinder	Exit Only Blank Plate	Nightlatch Access by Key	Nightlatch Cylinder by Pull	Classroom Cylinder Controls T-Piece	Storeroom Cylinder Controls T-Piece	Dummy Trim Pull Plate	Passage Active T-Piece
2100(F) 2150(F) 2110(F) 2120(F) 2160(F) 2170(F)	Rim	630F	631F ²	632F ²	633F	633F ¹	634F	635F
ANSI		01	03	03	05	06	02	15

¹ 06 achieved with single trim modification at installation.
² Not recommended for use with vertical rod exit devices.
 For 626 & 630 finishes the escutcheon is plated to simulate stainless steel.
 Optional door thickness available up to 4-1/2", specify on order.

Trim Designs



440F Series Rose Trim



- Certified ANSI/BHMA A156.3, Grade 1.
- 440F rose trim for stock doors.
- 1-3/4" (44mm) door standard. For doors through 2-1/4" (57mm) or shim-mounted devices, specify on order.
- AU, PB and MO trim designs. See below.
- Cylinders included, accepts 6-pin cylindrical type cylinders. If 7-pin cylinders are required, reference 540F trim from 7000 series catalog. See pages 25-27 for cylinder options.
- Finishes: 613E, 626, 689, 691, 693, 695, BSP
- "B" trim prefix - Lever trim accepting all small format interchangeable cores. 6- or 7-pin. (Example: B-AU446F)
- "M" trim prefix - Lever trim accepting Medeco® (32 series) and ASSA® large format interchangeable cores. Available in AU lever only. 6-pin only. (Example: M-AU446F)
- "S" trim prefix - Lever trim accepting Schlage® standard cylinders. 6-pin only. (Example: S-AU446F)
- "SI" trim prefix - Lever trim accepting Schlage® large format interchangeable cores. Available in AU and PB levers only. 6-pin only. (Example: SI-AU446F)
- Please specify when ordering 1210 LFIC prep.
- 2-year limited warranty.

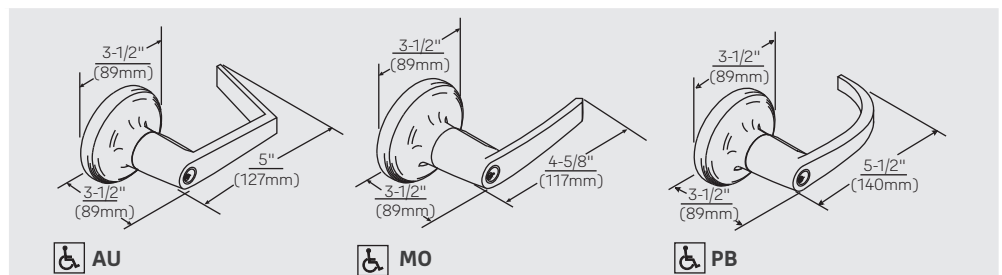

Applications	Nightlatch Access by Key	Classroom Cylinder Controls Lever	Dummy Trim Free Wheeling Lever	Passage Lever	Dummy Trim Rigid Lever
2100(F), 2150(F), 2110(F), 2120(F), 2160(F), 2170(F)	441F*	446F	448F	448F	449F
ANSI	03	08	02	14	02

* Not recommended for use with vertical rod exit devices.



Trim Designs

540F Series Rose Trim



- Certified ANSI/BHMA A156.3, Grade 1.
- 540F rose trim for stock doors.
- Trim through-bolts to exit device for strength.
- 1-3/4" (44mm) door standard. For doors through 2-1/4" (57mm) or shim-mounted devices, specify on order.
- AU, PB and MO trim designs.
- Accepts cylindrical type cylinders. Cylinders included, see pages 25-27 for cylinder options.
- Please specify when ordering 1210 LFIC prep.
- Finishes: 605, 606, 613E, 625, 626, BSP.
- 3-year limited warranty.

"B" trim prefix	Lever trim accepting all small format interchangeable cores. 6- or 7-pin (Example: B-AU546F)
"M" trim prefix	Lever trim accepting Medeco® (32 Series) and ASSA® large format interchangeable cores. Available in AU lever only. 6-pin only. (Example: M-AU546F)
"S" trim prefix	Lever trim accepting Schlage® standard cylinders. 6-pin only. (Example: S-AU546F)
"SI" trim prefix	Lever trim accepting Schlage® large format interchangeable cores. 6-pin only. (Example: SI-AU546F)

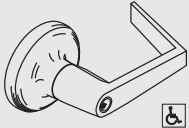
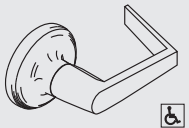
Applications					
	Nightlatch Access by Key	Classroom Cylinder Controls Lever	Passage Lever	Dummy Trim Free-Wheeling Lever	Dummy Trim Rigid Lever
6100ED(F), 6150ED(F), 6160ED(F), 6170ED(F)	541F*	546F	548F	548F	549F
ANSI	03	08	14	02	02

* Not recommended for use with vertical rod exit devices.

Trim Designs



580F Series Rose Trim With Escutcheon Plate



- 580F rose trim with escutcheon plate for stock doors.
- 1-3/4" (44mm) door standard. For doors thru 2-1/4" (57mm) or shim-mounted devices, specify on order.
- AU, PB and MO trim designs. See below.
- Plate Dimensions: 4" (102mm) x 8" (204mm) x 1/8" (3mm)
- Cylinders included, accepts cylindrical type cylinders. See pages 25-27.
- Finishes - lever and rose only: 613E, 626, 689, BSP.
- Finishes - escutcheon only: 689.
- "B" trim prefix - Lever trim accepting all small format interchangeable cores. 6- or 7-pin (Example: B-AU586F)
- "M" trim prefix - Lever trim accepting Medeco® (32 series) and ASSA® large format interchangeable cores. Available in AU lever only. 6-pin only. (Example: M-AU586F)
- "S" trim prefix - Lever trim accepting Schlage® standard cylinders. 6-pin only. (Example: S-AU586F)
- "SI" trim prefix - Lever trim accepting Schlage® large format interchangeable cores. 6-pin only. (Example: SI-AU586F)
- 3-year limited warranty.

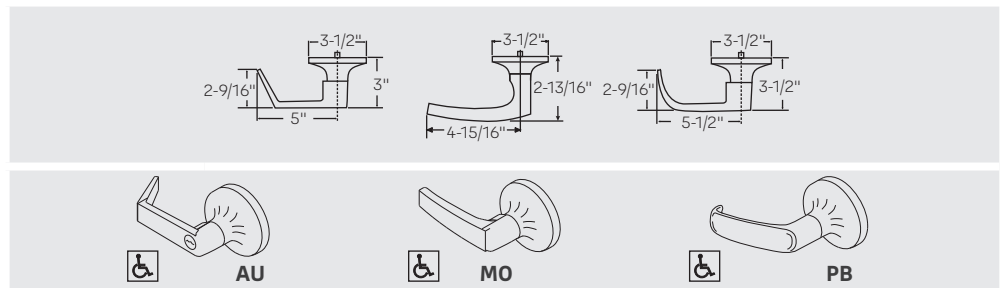

Applications	Nightlatch Access by Key	Classroom Cylinder Controls Lever	Dummy Trim Free Wheeling Lever	Passage Lever	Dummy Trim Rigid Lever
2100(F), 2150(F), 2110(F), 2120(F), 2160(F), 2170(F)	581F*	586F	588F	588F	589F
ANSI	03	08	02	14	02

* Not recommended for use with vertical rod exit devices.

Trim Designs



210F Series Trim



- 1-3/4" (44mm) door standard. For doors through 2-1/4" (54mm) or shim-mounted devices, specify on order.
- Cylinders not included. For rim cylinder options, see pages 25-27.
- Plate Dimensions: 3-1/2" x 3-3/4" x 3/32" (89mm x 95mm x 3mm)
- Finger Pull Dimensions: 3-1/2" x 6-3/4" x 1/8" (89mm x 171mm x 3mm)
- Finishes: 689, 691, 695

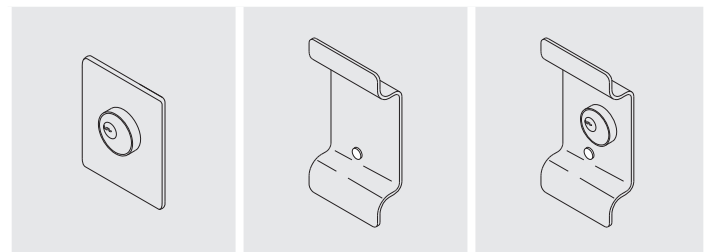

Applications	Cylinder	Nightlatch Access by Key	Dummy Trim Pull Plate	Nightlatch Cylinder by Pull
2100(F), 2150(F)	Rim	213F	214F	217F
ANSI		03	02	03

Not recommended for surface or concealed vertical rod devices.

Functions



SquareBolt® (Type 1 or 28) 2150(F)	Rim (Type 1) 2100(F)	Surface Vertical Rod (Type 2) 2110(F) 2170(F90)	Concealed Vertical Rod (Type 7 & 8) 2120(F) 2160(F90)	Function Description	ANSI Function No.	Trim Model Number
				Exit Only, No Trim/Exit Only, Blank Plate	01	620F 630F
				Pull to Open (Dummy Trim)	02	214F 589F ^{1,2} 448F ^{1,2} 624F 629F ² 449F ^{1,2} 625F 634F ² 588F ^{1,2} 628F ^{1,2}
				Key Retracts Latchbolts (NL)	03	121NL 581F ² 213F 621F 631F 217F 623F 632F ² 441F ² 627F ²
				Entrance by Thumbpiece (Key Locks/ Unlocks Thumbpiece)	05	633F
				Key Unlocks Thumbpiece (Key Removable When Locked)	06	633F ¹
				Entrance by Lever (Key Locks/ Unlocks Lever)	08	446F ² 586F ² 626F ²
				Key Unlocks Lever (Key Removable When Locked)	09	626F ^{1,2}
				Cylinder Controls Thumbturn	11	603F
				Key & Thumbturn (Key Removable When Locked)	12	
				Lever Always Active (Passage)	14	448F ² 588F ² 628F ²
				Thumbpiece Always Active (Passage)	15	635F

Sectional dummy trim (02) features levers that will turn, but will not operate the devices. For rigid lever use AU629F, or AU449F. Illustrations show typical function features, rather than pictorial renderings of the trims listed. Specific trim details are shown on pages 13-20.

¹ Trims require an easy field change to adapt them for the charted function. ² ADA compliant trim. ³ Application not recommended

Applications



Single Door	UL Listing	Maximum Opening	Application
SquareBolt®			
2150	Panic	4' x *	Surface applied; single-point latching.
2150F	3 Hr.	4' x 8'	
Rim			
2100	Panic	4' x *	Surface applied; single-point latching.
2100F	3 Hr.	4' x 8'	
2100WS	Panic	3' x 7'	Surface applied; single-point latching. Used as components in swinging door windstorm-rated assemblies (refer to local codes).
2100FWS	3 Hr.	3' x 7'	
Surface Vertical Rod			
2110	Panic	4' x 10'	Surface applied; two-point latching.
2170	Panic	4' x 10'	
2170 x LBR	Panic	4' x 10'	Surface applied; one-point latching.
Concealed Vertical Rod			
2120	Panic	4' x 10'	Rods concealed in door; two-point latching
2160	Panic	4' x 10'	
2160 x LBR	Panic	4' x 10'	Rods concealed in door; one-point latching

*UL does not set a door height limitation on panic applications.

Pair of Doors with Removable Mullion	UL Listing	Maximum Opening	Application
SquareBolt® x SquareBolt®			
2150 x 2150 x M200	Panic	8' x 10'	Two independent active doors with removable mullion.
2150F x 2150F x M200F	3 Hr.	8' x 8'	
Rim x Rim			
2100 x 2100 x M200	Panic	8' x 10'	Two independent active doors with removable mullion.
2100F x 2100F x M200F	3 Hr.	8' x 8'	

Pair of Doors with Keyed Removable Mullion	UL Listing	Maximum Opening	Application
SquareBolt® x SquareBolt®			
2150 x 2150 x KRM200	Panic	8' x 10'	Two independent active doors with removable mullion.
2150F x 2150F x KRM200F	3 Hr.	8' x 8'	
Rim x Rim			
2100 x 2100 x KRM200	Panic	8' x 10'	Two independent active doors with removable mullion.
2100F x 2100F x KRM200F	3 Hr.	8' x 8'	

Applications



Pair of Doors	UL Listing	Maximum Opening	Application
SquareBolt® x Surface Vertical Rod			
2150 x 2110	Panic	8' x 10'	Two independent doors with two-point latching, swinging in the same direction.
2150 x 2170	Panic	8' x 10'	Two independent doors with one- or two-point latching, swinging in the same direction.
Rim x Surface Vertical Rod			
2100 x 2110	Panic	8' x 10'	Two independent doors with two-point latching, swinging in the same direction.
2100 x 2170	Panic	8' x 10'	Two independent doors with one- or two-point latching, swinging in the same direction.
Surface Vertical Rod			
2110 x 2110	Panic	8' x 10'	Two independent doors with two-point latching, swinging in the same direction.
2110F x 2110F	3 Hr.	8' x 8'	
2170 x 2170	Panic	8' x 10'	Two independent doors with one- or two-point latching, swinging in the same direction.
2170F90 x 2170F90	1-1/2 Hr.	8' x 10'	
2170F x 2170F	3 Hr.	8' x 8'	
Surface Vertical Rod (Double Egress)			
2110 x 2110	Panic	8' x 10'	Two independent doors with two-point latching, swinging in opposite directions. Overlapping astragal required for 3-hour openings.
2110F x 2110F	3 Hr.	8' x 8'	
2170 x 2170	Panic	8' x 10'	Two independent doors with one- or two-point latching, swinging in opposite directions. Overlapping astragal not required.
2170F90 x 2170F90	1-1/2 Hr.	8' x 10'	
2170F x 2170F	3 Hr.	8' x 8'	
Concealed Vertical Rod			
2120 x 2120	Panic	8' x 10'	Two independent metal doors with two-point latching, swinging in the same direction.
2120F x 2120F	3 Hr.	8' x 8'	
2160 x 2160	Panic	8' x 10'	Two independent metal or wood doors with one- or two-point latching, swinging in the same direction.
2160F90 x 2160F90	1-1/2 Hr.	8' x 10'	
2160F x 2160F	3 Hr.	8' x 8'	
Concealed Vertical Rod (Double Egress)			
2120 x 2120	Panic	8' x 10'	Two independent metal doors with two-point latching, swinging in opposite directions. Overlapping astragal required for 3-hour openings.
2120F x 2120F	3 Hr.	8' x 8'	
2160 x 2160	Panic	8' x 10'	Two independent metal or wood doors with one- or two-point latching, swinging in opposite directions. Overlapping astragal not required.
2160F90 x 2160F90	1-1/2 Hr.	8' x 10'	
2160F x 2160F	3 Hr.	8' x 8'	

Electrified Options



Standalone Door Alarm

The SDA16 stand-alone battery operated door alarm is designed to continually monitor the status of a door. When the door is opened without authorization, an alarm is triggered to alert the security violation. This alarm features a Peizo horn which blasts a deafening 105+ decibels to alert the violation.

This unit is ideal for emergency doors as well as stairwell doors and rear exit doors in retail environments. The unit, which can also be hardwired, easily complements existing hardware, making any opening alarmed. The SDA16 door alarm is typically mounted on the interior of the door frame or door and is paired with a magnet mounted on the opposing side of the door gap.

Remote Mounting

The SDA16 can be installed remotely from the door by attaching the contacts to the door and frame. The unit can be installed up to 6 feet from the door. This provides the ideal solution for circumstances where exposure to weather may be an issue. To order specify "SDA16XL".

Cylinders And Accessories

- 784 Power supply (9VDC) — includes plug-in wall transformer
- Plug-in wall transformer with 12' cable assembly (part no. 00-0000-3425)
- Gel-cell battery — optional for use with 784 power supply (part no. 00-0000-3426)
- WH-11 Wire harness for remote power and remote unlock
- Mortise cylinder for unit
- Rim cylinder for outside control
- See pages 25-27 for cylinder information.

Features

- Dimensions: 8.3"L x 3.1"W x 2.0"D (210mm L x 79mm W x 52mm D)
- Non-handed unit (field reversible)
- Unit powered by 9V battery
- Unit can be hardwired by using WH-11 wire harness and 784 power supply
- No battery is required in unit with hard-wire option – if power is lost, optional gel-cell battery in power supply will give approximately 10,000 operations
- Reverse battery protection safeguards the unit if the battery is incorrectly installed
- A low-voltage battery is indicated by an audible signal every 30 seconds
- Piezo horn blasts at 105+ decibels if the door is used without proper authorization
- The LED will flash every 30 seconds, indicating either the unit is armed or, if under auto reset, that the door has been violated
- Various field-adjustable features by dip switch including automatic alarm reset, REX and passage time delay, and LED color preference
- A tamper switch provides instantaneous signal to sound horn in the event the cover is removed. Horn will sound until the unit is reset by the key or remote reset/arm switch
- Conformally coated electronics for weather resistance
- Cover is held in place by cam lock which protects mounting screws, electrical system and internal sensors
- Accepts external cylinder (not included, must be specified)
- Accepts standard mortise cylinders (not included, must be specified)

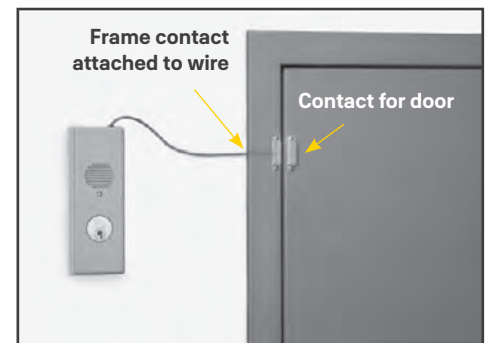

Note: Actual wire length is 6 feet.

Cylinders



Rim

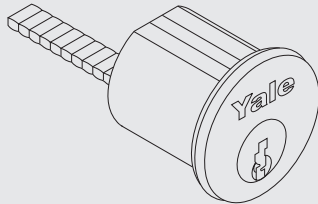

Collar Requirements*

Model #	Description	Pins	Length	620F	630F	210F	121NL	SDA16 Outside	
1109	Standard Fixed Core	6	1-1/4"	No Collar	No Collar	1765.250	1765.250	1765.250	
1109	Standard Fixed Core	7	1-7/16"	KP4	KP4				
1709	CMK	6	1-15/16"	1765.250	1765.250	1765.500			
1709	CMK	7	1-5/8"		1765.406				
1193	LFIC Complete	6	1-7/16"		1765.250	1765.469			
1193	LFIC Complete	7	1-5/8"	1765.344	1765.406	1765.656			
5109	Security Fixed Core	6	1-9/16"	No Collar	1765.250	1765.250			
5109	Security Fixed Core	7	1-7/16"		No Collar	No Collar			No Collar
U5109	High Security Fixed Core	6	1"			No Collar			No Collar
U5109	High Security Fixed Core	7	1"						No Collar
5193	Security LFIC Complete	6	1-7/16"	1765.250	1765.250	1765.469	1765.250	1765.250	
5193	Security LFIC Complete	7	1-5/8"	1765.344	1765.406	1765.656			
K300	Yale® KeyMark® Standard Fixed Core	6	1-1/8"	KP4	1765.250	1765.406			
K300	Yale KeyMark Standard Fixed Core	7							
K840/ K880	Yale KeyMark LFIC Complete / Housing Only	6	1-7/16"	1765.406	1765.500	1765.719			
K840/ K880	Yale KeyMark LFIC Complete / Housing Only	7	1-5/8"	1765.563	1765.719	1765.937			
K640/ K680	Yale KeyMark SFIC Complete / Housing Only	6	1-1/4"	KP4	1765.250	1765.406			
K640/ K680	Yale KeyMark SFIC Complete / Housing Only	6 or 7	1-3/8"	1765.187	1765.406	1765.563			
A640/ K680	Best® Keyway SFIC Complete / Housing Only	6	1-1/4"	KP4	1765.250	1765.406			
A640/ K680	Best® Keyway SFIC Complete / Housing Only	6 or 7	1-3/8"	1765.187	1765.406	1765.563			
2109	Schlage® "C" Keyway Fixed Core Available 0-bitted or keyed random.	6	1-1/8"	No Collar	No Collar	1765.250			

*Based on 1-3/4" door thickness. Collar length required must be specified for cylinders and/or housings ordered separately.

LFIC = Large Format Interchangeable Core

SFIC = Small Format Interchangeable Core

Cylinders



Component

The following chart details component cylinders for use with 440F and 540F series trim.

Model #	Description	Pins
1802	Standard Lever Fixed Core	6
1802A*	Standard Lever Fixed Core	7
5802	Security Lever Fixed Core	6
5802A*	Security Lever Fixed Core	7
1210	LFIC Only	6
1220*	LFIC Only	7
5210	Security LFIC Only	6
5220*	Security LFIC Only	7
K402*	Yale® KeyMark® Lever Fixed Core	6 or 7
K800*	Yale KeyMark LFIC Only	6 or 7
K600	Yale KeyMark SFIC Only	6 or 7
A600	Best® Keyway SFIC Only	6 or 7
2802	Schlage® "C" Keyway Fixed Core. Available 0-bitted or keyed random.	6
3804 ¹	Corbin Russwin "L4", Corbin "60", Russwin "D1", Sargent® "LA" or Schlage® "E" Keyway Fixed Core. Specify keyway. Available keyed random	6

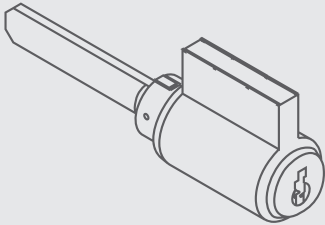

*7-pin not available for 440F series trim. If 7-pin required, refer to 540F series located in 7000 series exit device catalog.

¹440 series trim requires the 108S kit. These cylinders are not ANSI/BHMA certified.

121NL Cylinder Only

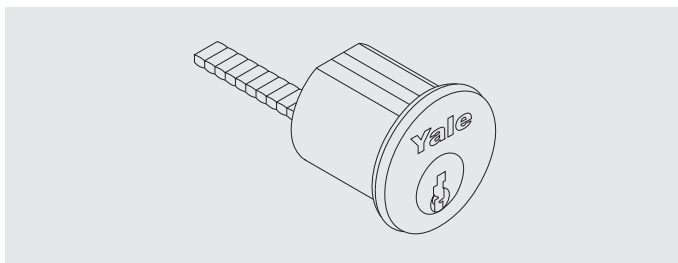

Function Description	Nightlatch Access by Key
Model No.	121NL
ANSI	03

- Application: 2100(F) and 2150(F) rim and SquareBolt® exit devices. Not recommended for surface or concealed vertical rod devices.
- Must specify rim cylinder when ordering. See pages 25-27 for cylinder options.
- Cylinder collar 1765.250 furnished standard for 1-3/4" thick doors.
- For 1109, 5109, K300, K640, A640 and 2109 cylinders:
 - Screw part number 34-2311-8738-048
 - Backplate part number 34-0010-1015-059
- For 1193, 5193 and K840 cylinders:
 - Screw part number 10-1193-1018-048
 - Backplate part number 34-0010-1015-059

Cylinders



Mortise

The following chart details mortise cylinders for use with cylinder dogging, 2116 alarms, inside of SDA16 and KRM200 mullions:

				Cylinder Dogging**		2116 Alarm*		SDA16 Inside		KRM200				
				Cam	Collar	Cam	Collar	Cam	Collar	Cam	Collar			
Model #	Description	Pins	Length	Cam	Collar	Cam	Collar	Cam	Collar	Cam	Collar			
2153	Standard Fixed Core	6	1-1/8"	1161E	NA	2160	No Collar	2160	No Collar	2160	1765.312			
2153	Standard Fixed Core	7	1-1/4"								1765.500			
2196	LFIC Complete	6	1-1/2"		599.925		1765.250		1765.750					
2197	LFIC Complete	7	1-11/16"		599.1.04		1765.500		1765.844					
5153	Security Fixed Core	6	1-1/8"		NA		No Collar		2160		No Collar	2160	2160	1765.312
5153	Security Fixed Core	7	1-1/4"											1765.500
U5153	High Security Fixed Core	6	1-1/8"		NA		NA		NA		NA	NA	NA	NA
U5153	High Security Fixed Core	7	1-1/4"											NA
5196	Security LFIC Complete	6	1-1/2"		599.925		1765.250		1765.750					
5197	Security LFIC Complete	7	1-11/16"		599.1.04		1765.500		1765.844					
K100	Yale® KeyMark® Standard Fixed Core	6 or 7	1-1/8"	Special	NA	KC1	No Collar	KC1	No Collar	KC1	1765.312			
K820/ K860	Yale KeyMark LFIC Complete / Housing Only	6	1-1/2"		599.925		1765.250		1765.750					
K820/ K860	Yale KeyMark LFIC Complete / Housing Only	7	1-11/16"		599.1.04		1765.500		1765.000					
K620/ K660	Yale KeyMark SFIC Complete / Housing Only	6	1-1/4"		599.700		No Collar		1765.500					
K620/ K660	Yale KeyMark SFIC Complete / Housing Only	6 or 7	1-3/8"		599.850		1765.250		1765.563					
A620/ K660	Best® Keyway SFIC Complete / Housing Only	6	1-1/4"		599.700		No Collar		No Collar		1765.500			
A620/ K660	Best® Keyway SFIC Complete / Housing Only	6 or 7	1-3/8"		599.850						1765.563			
2553	Schlage® "C" Keyway Fixed Core. Available 0-bitted or keyed random.	6	1-1/8"		1161E		NA		2160			2160		2160

Based on 1-3/4" door thickness. Collar length required must be specified for cylinders and/or housings ordered separately.

LFIC = Large Format Interchangeable Core. SFIC = Small Format Interchangeable Core

NA = Application Not Available

*2116 door alarm kit discontinued September 1, 2012.

**Cylinder dogging discontinued August, 2013

Cams

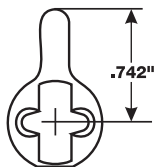

2160

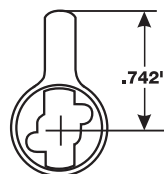

KC1

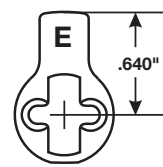

1161E



Collars & Tailpieces

Cylinder Collars

If required, cylinder collar size must be specified.

<p>1765 Recessed Cylinder Collar "A" Dimension: Thicknesses from 1/16" (2mm) to 1-15/32" (37mm) as required. Material: Brass, Bronze</p>	<p>KP3 Wave Washer (Furnished standard with 1765 collar for Yale® KeyMark® cylinders and 630F series trim).</p>	<p>599 Recessed Cylinder Collar with Radius "A" Dimension: Thicknesses from 1/16" (2mm) to 1-15/32" (37mm) as required. Material: Brass, Bronze</p>	<p>KP4 Flush Mount Cylinder Collar Material: Brass, Bronze</p>

Long Tailpiece Kit

Long tailpiece kit for use with escutcheon series trim, up to 4-1/2" thick doors. Specify part number to order.

Door Thickness	Trim Type	Part Number
2" - 2-1/2"	620F and 630F Series Trim	81-9500-1665-000
2-1/2" - 3-1/2"	620F and 630F Series Trim	81-9500-1635-000
3-1/2" - 4-1/2"	620F and 630F Series Trim	81-9500-1636-000

Von Duprin® Tailpiece

This tailpiece is available for the Yale® 1109 rim cylinder to operate the night latch function for Von Duprin® exit devices. To order, specify part number: 34-1145-1005-048.



Strikes



Rim Devices

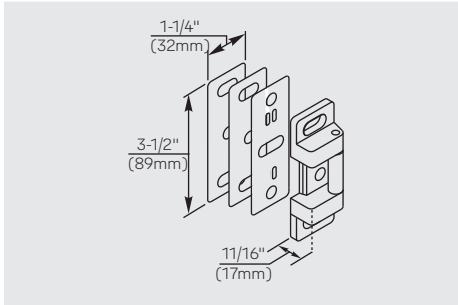

757F
Standard strike for 2100(F) and 2150(F) devices. Supplied with #10-24 x 3/4" machine screws, two shims (each 1/16" thick), and one locking plate.

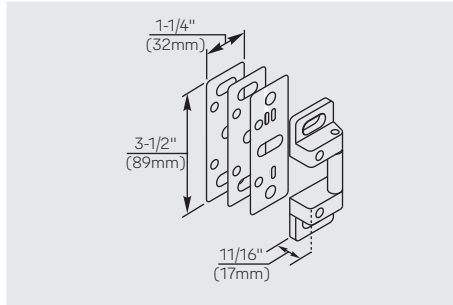

757FWS
Standard strike for 2150(F)WS and 2250M(F)WS devices. Supplied with 2 each #10-24 x 1-1/4" and 2 each #10-24 x 3/4" machine screws, two shims (each 1/16" thick), one locking plate and one interlocking bracket (not shown) with 4 each #10-24 x 3/4" machine screws.

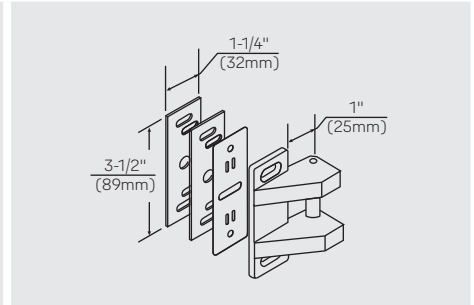

793
Optional strike for double door applications without a mullion. Supplied with #10-24 x 3/4" machine screws, two shims (each 1/16" thick), and one locking plate. Panic only.

Vertical Rod Devices - Top Strikes

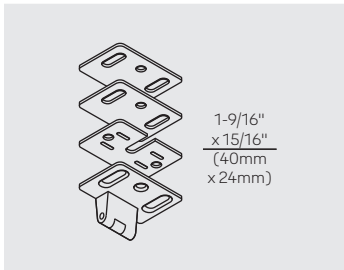

791
Standard top strike for 7110(F), 7120(F), 7210, 7220, 7210M(F), 7220M(F) series devices. Supplied with #10-24 x 3/4" machine screws, two shims (each 1/16" thick), and one locking plate.

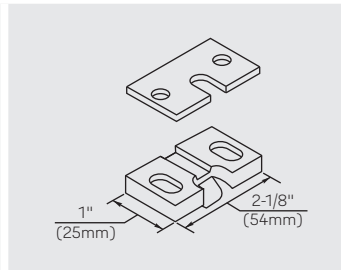

726
Standard top strike for 7170(F) series devices. Supplied with #12-24 x 11/16" machine screws and #12 x 1-1/4" sheet metal screws, and one shim (1/16" thick).

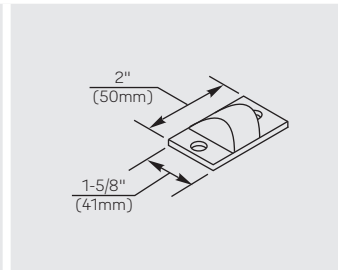

761
Standard top strike for 7160(F) series devices. Supplied with #10-32 x 3/8" machine screws and #10 x 1" sheet metal screws.

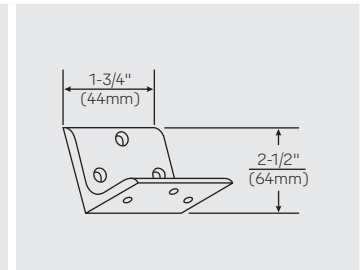

797
Optional bracket for mounting 791 top strike in flush transom opening. Supplied with 1/4-20 machine screws; SN-134 sex nuts, optional.

Vertical Rod Devices - Bottom Strikes

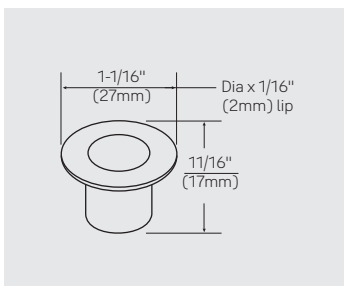

790
Standard bottom strike for 7110(F), 7120(F), 7160(F), 7170(F), 7210, 7220, 7210M(F), 7220M(F) series devices. Press in place.

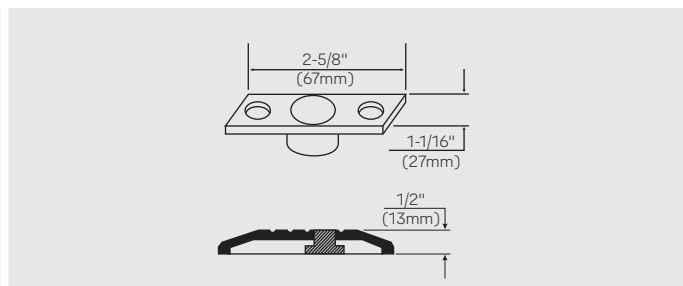

794
Optional bottom strike for fire openings using saddle thresholds or for flush floor mount. Must use for fire openings with 1/2" thresholds. Supplied with #10-24 x 1/2" machine screws and floor anchors.

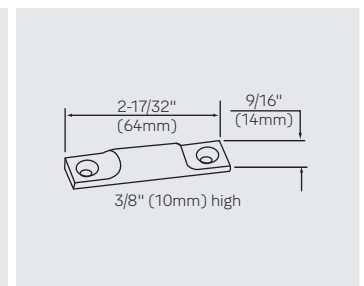

702
Optional bottom strike for bottom pullman latch option. Supplied with #8 x 8/32" combination screws.



Accessories & Options

Shim Kits

Shim kits are available for devices on doors with interfering molding. Each shim kit contains:

- 2 sets of 1/8" shims (shim up to 1/4")
- Longer fasteners
- Longer tailpiece for the trim
- Installation instructions
- 693 (Black) finish

223 - Shim kit for 2100(F) rim, 2150(F) SquareBolt® and 2120(F) and 2160(F) series* concealed vertical rod exit devices

224 - Shim kit for 2110(F) and 2170(F) series surface vertical rod exit devices.

*Special concealed vertical rod components needed for openings requiring more than (2) shim kits. Details on application.

Extension Rods

2110 surface vertical rod devices are supplied standard for 7' (2.13m) standard. Rods may be field cut or used with extension rods for other heights. To order, specify:

Model Number	Length
2010-2	2" (51mm)
2010-6	6" (153mm)
2010-12	12" (305mm)
2010-24*	24" (610mm)

*Used for 10' door applications with 2170(F90)

Specialty Fasteners

Sex Nuts:

Required for wood, composite or unreinforced metal doors.

To order specify:

- **SN-104** – pack of (4) 10-24 sex nuts for all fire rim exits
- **SN-134** – pack of (4) 1/4-20 sex nuts for all devices

Wood Door Fasteners:

For solid core wood doors, permitted if pilot holes are used to install screws. Consult the factory for availability.

Torx® Security Screws available for factory product orders.

Bottom Pullman Latch

Optional bottom Pullman latch available for panic-listed vertical rod exit devices. To order with devices, specify "BPL." 702 bottom strike required, see page 29.

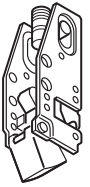

Wide Stile Cover

2100 series devices are available with an optional wide stile cover. To order with device, specify option: "WIDE".



To order cover separately, specify part number:

60-2000-1241 x Finish = for use with 2100

60-2150-1244 x Finish = for use with 2150

60-2110-1243 x Finish = for use with 2110 & 2170

60-2000-1240 x Finish = for use with 2120 & 2160

Plastic Installation Template

Provided as a standard with all 2100 series exit device, the plastic installation template facilitates door markings over traditional paper templates. This provides a more accurate door prep which reduces installation mistakes and overall installation time. Template dimensions: 8-1/4"x 3-1/4"(210mm x 83mm). To order separately, specify part number: 60-7000-9100-999.

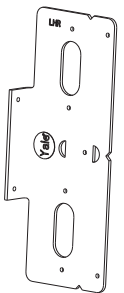

Schlage® Cam Assembly

This cam and housing assembly includes a cam engineered to accept Schlage® rim cylinders. No modifications are required to existing 500 and 600 series exit device trims thus maintaining the trim's classroom and storeroom functions. To order, specify part number: 60-7000-0815.

Mullions

M200(F) Removable Mullion

M200(F) steel mullions are for use with 2100(F) series exit devices. Mullions may be field cut to fit opening. Red primer finish.

- M200 panic rated.
Tubular steel, 2" x 3" (51mm x 76mm). Specify 7', 8', or 10'.
- M200F 3 hour fire rated.
Tubular steel, 2" x 3" (51mm x 76mm). Specify 7' or 8'.

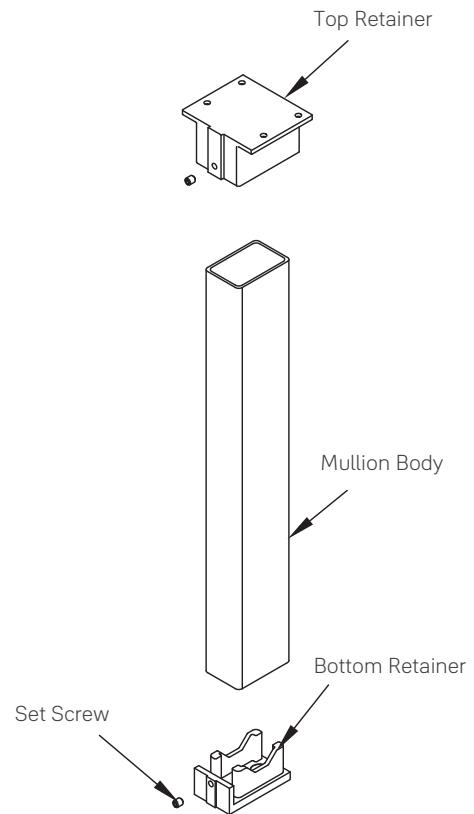

M200(F) Options

- **M203 Spacer Block**
Recommended for double rabbeted frames where the stop face width is less than the mounting hole spacing or for applications with 5-3/4" (146mm) or less door frames.

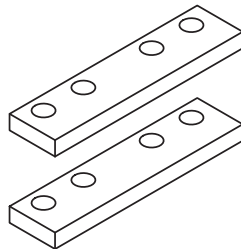

- **M204 Angle Bracket**
Recommended for any header configuration with less than 3" (76mm) of mounting surface.

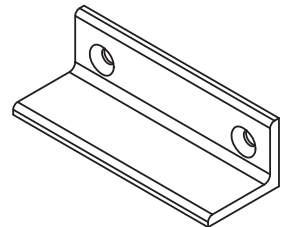

Mullions



KRM200(F) Keyed Removable Mullion (KRM)

Keyed removable mullions are for use with 2100(F) series exit devices. They are designed for simple removing when an unobstructed large opening is required and easy replacement and locking to maintain the integrity of the opening.

- KRM200 panic rated. Specify 7', 8', or 10'.
- KRM200F 1-1/2 hour fire rated. Specify 7' or 8'.
- Easy cylinder installation.
- Mullion automatically relocks when reinstalled without the use of the cylinder key.
- When ordering, add KR prefix to mullion, example: KRM200 and KRM200F.

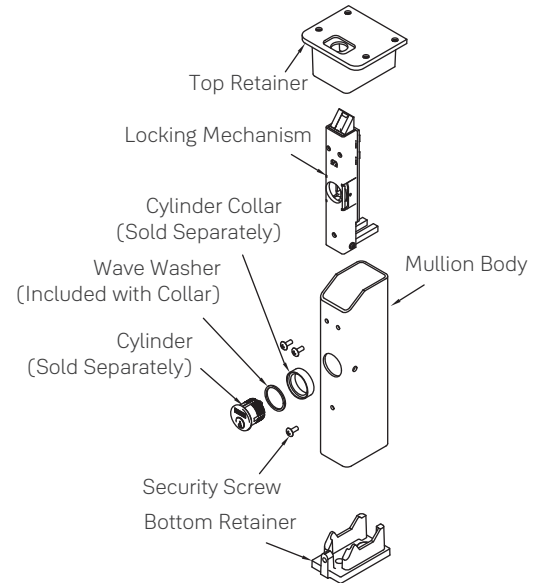

KRM Options

• M203 Spacer Block

Recommended for double rabbeted frames where the stop face width is less than the mounting hole spacing or for applications with 5-3/4" (146mm) or less door frames.

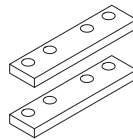

• M204 Angle Bracket

Recommended for any header configuration with less than 3" (76mm) of mounting surface.

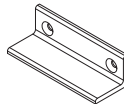

KRM Cylinders

As with any exit device trim, you must order a cylinder and collar if one is required. The Yale® keyed removable mullion accepts a mortise cylinder. Refer to page 27 for details.



Dimensions

Device

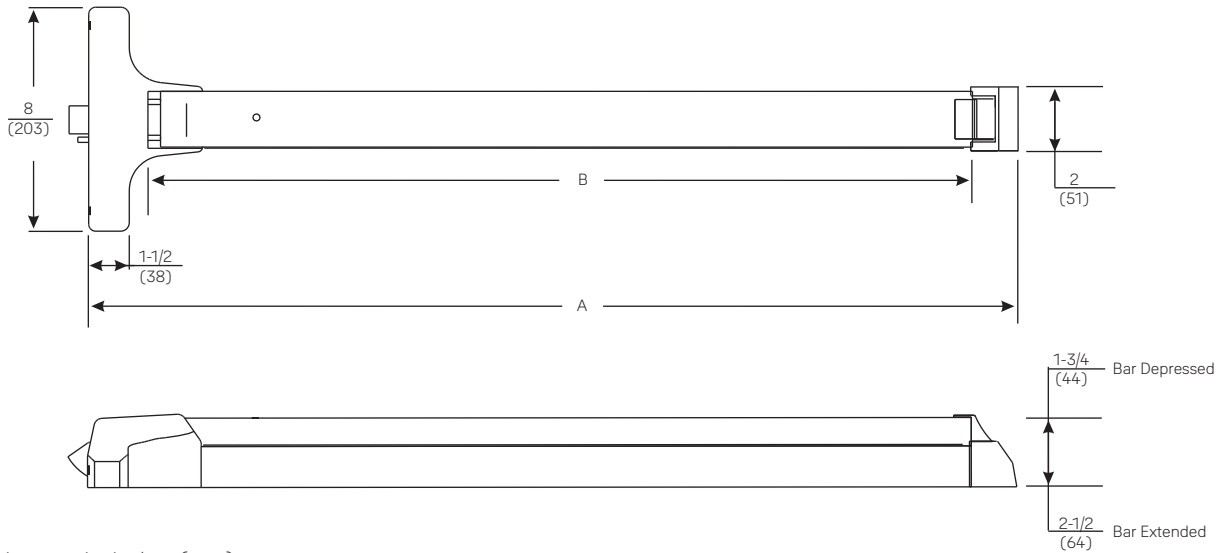

Dimensions are in: inches (mm)

Device Size	"A"	"B"
36"	32-3/8" (82cm)	27" (69cm)
42"	38-3/8" (98cm)	33" (84cm)
48"	44-3/8" (113cm)	39" (99cm)

Trim Dimensions

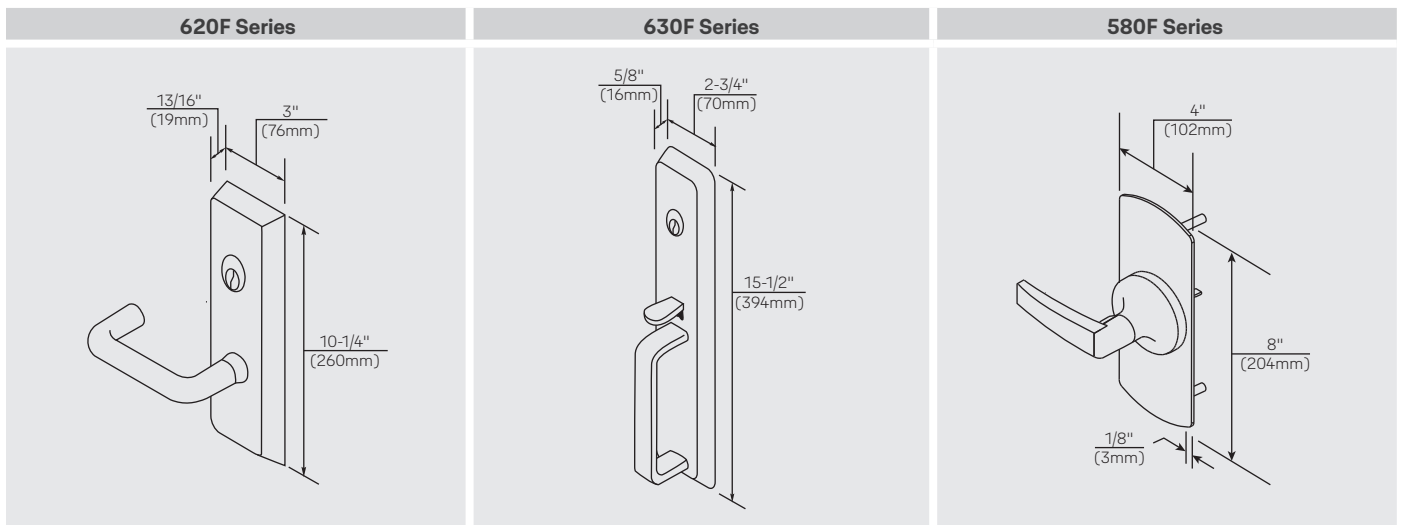

Sample Specification



Exit devices shall be 2100 Series Pushpad Exit Devices as manufactured by Yale Locks & Hardware.

The exit device chassis and push pad assembly shall be of high-grade non-ferrous steel material, electroplated for protection against rust, and shall have a baked powder coating. The maximum projection shall be 2-1/2" when the push pad is active and 1-3/4" when the push pad is dogged down. Nylon bearings and stainless steel springs shall be used for long life and durability; only torsion springs are acceptable. Rear and active case covers shall be steel and shall have a baked powder coating to match the exit bar. Plastic covers are not acceptable. Latchbolts shall be steel and shall incorporate a deadlocking latch for increased security. Devices without deadlocking latches are not acceptable. Mounting screws shall be concealed to deter tampering. Devices shall be closed on all sides with no pinch points. Exit devices shall be easily field sized to accommodate various door widths.

Panic-listed exit devices shall have single point, one quarter turn hex key dogging standard. Panic-listed devices shall be available less dogging.

Trims shall be through-bolted with concealed fasteners. Escutcheon and pull-type trims shall be constructed of brass, bronze or zinc. All lever trims shall use cast or forged levers. On rim and vertical rod trims with cylinders, the mechanism that locks and unlocks the trim shall be housed in the trim and not in the active case of the exit device. Lever trims shall be Free Wheeling with clutch mechanism allowing lever to rotate 60° when locked for ideal protection. Lever trims shall match those on Yale® mortise and cylindrical locksets.

Exit devices and trims shall be furnished in ANSI/BHMA standard architectural finishes. Exit devices shall be listed by Underwriters Laboratories (UL, cUL) for safety as panic hardware. Fire-rated devices shall be listed for "A" label and lesser class doors. Devices shall also be UL listed for ZHEM - latching hardware and ZHLA - windstorm rated assemblies.

Certification:

ANSI/BHMA A156.3, Grade 1

Devices, trims and cylinders shall be from one manufacturer. Devices shall carry a three-year warranty and escutcheon trims shall carry a five-year warranty.



Technical Specifications & Listings

ANSI/BHMA

Certified ANSI/BHMA A156.3, Grade 1.



ISO 9001

Designed and manufactured under a certified ISO 9001 quality system.

Fire Listings

2100F series exit devices are UL-cUL Listed for use on fire doors having a rating up to and including 3-hours unless otherwise noted.

Note: Any retrofit or other field modification to a fire rated opening can potentially impact the fire rating of the opening, and Yale Locks & Hardware makes no representations or warranties concerning what such impact may be in any specific situation. When retrofitting any portion of an existing fire rated opening, or specifying and installing a new fire-rated opening, please consult with a code specialist or local code official (Authority Having Jurisdiction) to ensure compliance with all applicable codes and ratings.

Warranty

The 2100 series exit devices carry a three-year warranty. Rose trims carry a two-year warranty and escutcheon trims carry a five-year warranty.

Free Wheeling Lever Trim

2100 exit device lever trims feature the unique Free Wheeling lever mechanism. This Free Wheeling trim features a clutch mechanism which allows the lever to float down 60° when operated in the locked condition, greatly improving vandal resistance.

Microshield®

2100 series exit devices and trims are available with MicroShield antimicrobial coating. MicroShield is a revolutionary hardware finish coating which inhibits the growth of bacteria, algae, yeast fungus, mold and mildew. MicroShield is non-toxic and lasts for the lifetime of the finish to which it is applied. To order, suffix option code "YMS".

Note: MicroShield coating may vary finish color from architectural standards. MicroShield is not intended as a substitute for traditional infection control programs such as hand hygiene or use of disinfectants. Coated products must still be cleaned to insure the surfaces will be free of destructive microbes. Yale makes no representations or warranties, express or implied, as to the efficacy of the MicroShield antimicrobial. A copy of the MicroShield warranty is available upon request.

Windstorm



Certified (refer to local codes). Specify suffix "WS" to 2100(F) device.



Trusted every day

Phone

1-855-557-5078

Customer Service Email

customerservice.yale@assaabloy.com

Technical Product Support Email

techsupport.yale@assaabloy.com

Order Entry Email

orders.yaleus@assaabloy.com

Fax

1-800-338-0965

Website

www.yalecommercial.com

Contact Us

U.S.A.

Yale Locks & Hardware

Address: 225 Episcopal Road

Berlin, CT 06037-4004

Tel: 1-800-438-1951

Fax: 1-800-338-0965

us.yalehome.com

yalecommercial.com

Canada:

ASSA ABLOY Door Security Solutions Canada

Address: 160 Four Valley Drive

Vaughan, Ontario L4K 4T9

Tel: 1-800-461-3007

Fax: 1-800-461-8989

assaabloydss.ca

International:

ASSA ABLOY Americas International

Tel: 1-905-821-7775

Fax: 1-905-821-1429

assaabloyai.com

MicroShield®

ASSA ABLOY Group companies offer MicroShield®, an anti-microbial coating for door hardware. MicroShield uses proven silver ion-based technology from Agion®, a leading provider of antimicrobial solutions, to stem the spread of bacteria and other microbes.

MicroShield® is a registered trademark of ASSA ABLOY Access and Egress Hardware Group, Inc.



The Agion antimicrobial is not intended as a substitute for good hygiene. Coated products must still be cleaned to ensure the surfaces will be free of destructive microbes. ASSA ABLOY makes no representations or warranties, express or implied, as to the efficacy of the Agion antimicrobial. A copy of the Agion warranty is available upon request. Agion is a registered trademark of Agion Technologies, Inc., Wakefield, MA, USA.

THE YALE BRAND, with its unparalleled global reach and range of products, reassures more people in more countries than any other consumer locking solution.

THE ASSA ABLOY GROUP is the world's leading manufacturer and supplier of locking solutions, dedicated to satisfying end-user needs for security, safety and convenience.

Yale Commercial is a business associated with ASSA ABLOY Access and Egress Hardware Group, Inc., an ASSA ABLOY Group company. Copyright © 2002-2021, ASSA ABLOY Access and Egress Hardware Group, Inc. All rights reserved. Reproduction in whole or in part without the express written permission of ASSA ABLOY Access and Egress Hardware Group, Inc. is prohibited. Patent pending and/or patent www.assaabloydss.com/patents.



1800 Series Flatbar Exit Devices





Table of Contents

Contents

- Introduction 3
- Benefits & Features..... 4
- Finishes 5
- How to Order 6
- 1800(F) Rim..... 7
- 1810(F) Surface Vertical Rod..... 8
- Trim Designs..... 9-12
- Functions..... 13
- Applications 14
- Cylinders 15-16
- Strikes..... 17
- Accessories..... 18
- Mullions 19-20
- Dimensions..... 21
- Technical Specifications & Listings 22

1800 Flatbar Exit Devices

Yale 1800 Series Exit Devices are the ideal choice for economy commercial applications where you need consistent quality, dependability and ease of use and installation. The 1800 Series is ANSI/BHMA certified Grade 1, with durable construction and versatile mounting applications, making it ideal for a variety of facilities.





Offering strength and durability in one reliable product after another, Yale Works for YouSM.

Introduction



Yale® Commercial Solutions offers innovative and reliable products to solve the challenges of commercial, retail, hospitality, assisted living, mixed-use, and multi-family properties. With over 150 years of door hardware experience, Yale's expertise extends beyond products to people - and provides the service and support you expect.

Featuring durable products to meet all your facilities' requirements - and the quality you expect from a leader in the hardware industry. Yale works for youSM.

Yale Exit Devices			
7000 Series	6000 Series	2100 Series	1500 Series
			
<ul style="list-style-type: none"> • Ideal for facilities that require durability and innovation to meet their security needs • Wide & Narrow Stile Applications • Rim, SquareBolt, Mortise, SVR & CVR • Mechanical & Electro-Mechanical Functions • Available with Motorized Electric Latch Retraction • Constructed with high quality steel and heavy-duty components • 16 Standard finishes including BSP (Black Suede Powder Coat) • UL Rated for Panic & Fire • ANSI/BHMA Certified Grade 1 • 5 Year Warranty and Two-Year Limited Warranty on Electronic Components • UL Rated for Panic & Fire, Windstorm Rated Options (refer to local codes) 	<ul style="list-style-type: none"> • Ideal for facilities that require modern form and full functionality to meet their life safety needs • Wide & Narrow Stile Applications • Rim, Squarebolt, CVR, SVR & Mortise • Mechanical & Electro-Mechanical Functions • Aluminum rail assembly with Architectural Metals • Solid Cast Flush End Cap • ANSI/BHMA Certified Grade 1 • UL Rated for Panic & Fire • 10 Year Warranty 	<ul style="list-style-type: none"> • Ideal for commercial applications and budget conscious end users • Narrow & Wide Stile Applications • Rim, Squarebolt, CVR & SVR • Mechanical Functions • ANSI/BHMA Grade 1 Certified • UL Rated for Panic & Fire • Architectural & Painted Finishes • 3 Year Warranty 	<ul style="list-style-type: none"> • Ideal for renovation projects where historical preservation is the desired look • Wide Stile Applications • Rim, CVR, SVR & Mortise • ANSI/BHMA Certified Grade 1 • UL Rated for Panic & Fire • Architectural & Painted Finishes • 1 Year Warranty

Benefits & Features



Benefits

- **Tough:** Sturdy construction is ideal for meeting the rigors of demanding industry environments
- **Versatile:** Available in standard painted as well as architectural finishes for both front and back of house applications
- **Economical:** Works for a variety building projects, regardless of budget
- **Strong & Durable:** ANSI/BHMA Grade 1 Certification ensures long life and reliability







Features

- High-grade steel components offer superior protection against wear & tear
- Available in a variety of functions and finishes for any application
- ANSI/BHMA Grade 1 certified 
- UL/cUL listed for fire rated doors
- One year warranty

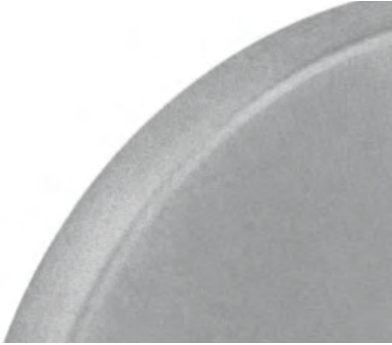

Finishes



ANSI/BHMA Code Finish Description		
626* Satin Chrome Plated (Trim Only)	630* Satin Stainless Steel (Trim Only)	689 Aluminum Painted
		
691 Light Bronze Painted	693 Black Painted	695 Dark Bronze Painted
		
WSP White Suede Powder Coat		
		

*Finish available with MicroShield® antimicrobial coating, additional finishes by special application. Consult factory for availability.

MicroShield coating may vary finish color from architectural standards. MicroShield is not intended as a substitute for traditional infection control programs such as hand hygiene or use of disinfectants. Coated products must still be cleaned to ensure the surfaces will be free of destructive microbes. Yale makes no representations or warranties, express or implied, as to the efficacy of MicroShield.

How to Order



18	1	X	0	Suffix	-XX	Outside Trim	Finish	Other Info
		Third Digit: "0" - Rim Device "1" - SVR Device		Trim Suffix: No Suffix - Panic label "F" - Fire label	Size: (DOW=Door Opening Width) "36" - 30" to 36" (76cm to 91cm) "42" - 36" to 42" (91cm to 107cm) "48" - 42" to 48" (107cm to 122cm)	Trim Model Number See pages 9-12	626 689 691 693 695 WSP	Other Information: Door Hand - RHR or LHR (SVR or Lever Escutcheon Trim only). Devices are field reversible. SN-134, 1/4-20 Sex Nuts (pack of 4). SN-104, 10-24 Sex Nuts (pack of 4). Door Thickness: over 1-3/4" (45mm). Rod Extensions: (quantity) 2010-2 (quantity) 2010-6 (quantity) 2010-12 Shim Kits: (quantity) 223 (quantity) 224 Optional Strike (page 17) Removable Mullion: M200 (Panic) M200F (Fire) KRM200 (Panic) KRM200F (Fire) Factory Keying Bottom Pullman Latch (SVR Devices)

Notes:

- It is recommended that exit devices and trim for the same opening be ordered together.
- Standard product is for 1-3/4" (44mm) reinforced metal doors.
- Accessories detached from the device and trim should be specified separately.
- 626 finish offered for 440F series trim only.

1800(F) Rim



The 1800(F) is a rim exit device to be used with single doors or pairs of doors constructed of metal, wood or composite materials. The 1800(F) can be paired with a wide variety of trims to meet many applications.



Certification/Compliance

UL/cUL Listed: FVSR/FVSR7 - Panic hardware
GXHX/GXHX7 - Fire exit hardware (F)
(up to 4' x 8' single, 8' x 8' pairs, 3 hr.)

ANSI/BHMA Certified: A156.3 Type 1, Grade 1



Features

- Designed for wide stile doors
- Non-handed for easy installation
- Steel interlock "E" bracket maintains door-to-mullion relationship in fire-labeled devices

Applications

- Single swing doors
- Pairs of doors (mullion required)
- Metal, wood or composite door materials

Specifications

Door Opening Width	-36 for 30" - 36" (76cm - 91cm) doors -42 for 36" - 42" (91cm - 107cm) doors -48 for 42" - 48" (107cm - 122cm) doors
Door Thickness	1-3/4" (44mm) standard. Refer to page 18 for other door thicknesses
Minimum Stile Width	4-1/2" (114mm)
Projection	2-1/2" (64mm) active, 1-3/4" (44mm) depressed
Strike	757F, 793 optional (double door application)
Trims	210F series utility trim, 420F series escutcheon trim, 440F series rose trim
Dogging	Hex key dogging supplied standard on panic devices
Finishes	689, 691, 693, 695
Options	Shim Kit #223, Sex Nuts and Bolts
Warranty	1-year limited



1810(F) Surface Vertical Rod

The 1810(F) is a surface vertical rod exit device to be used on metal, wood or composite pairs of doors up to 8' where two-point latching is desired.

Certification/Compliance

UL/cUL Listed: FVSR/FVSR7 - Panic hardware
GXHX/GXHX7 - Fire exit hardware (F)
(up to 4' x 8' single, 8' x 8' pairs, 3 hr.)

ANSI/BHMA

Certified: A156.3 Type 2, Grade 1



Features

- Designed for wide stile and flush doors
- Handed, specify hand (field reversible)
- Positive action linkage on a deadlocking top Pullman bolt
- Simultaneous direct pull bottom deadbolt
- When unlatched, device keeps both bolts retracted until door is shut.

Applications

- Pairs of doors
- Double egress
- Metal, wood or composite door materials

Specifications

Door Opening Width	-36 for 30" - 36" (76cm - 91cm) doors -42 for 36" - 42" (91cm - 107cm) doors -48 for 42" - 48" (107cm - 122cm) doors
Door Opening Height	Standard door height 7' (213cm), with the device centerline at 39-15/16" (101cm) from floor Optional heights up to 8' (244cm) by using rod extensions
Door Thickness	1-3/4" (44mm) standard. Refer to page 18 for other door thicknesses
Minimum Stile Width	4-1/2" (114mm)
Projection	2-1/2" (64mm) active, 1-3/4" (44mm) depressed
Strike	Top: Roller type 791. Bottom: Flush mounted 790. 794 floor strike optional (threshold openings), 702 optional (Bottom Pullman Latch)
Trims	210F series utility trim, 420F series escutcheon trim, 440F series rose trim
Dogging	Hex key dogging supplied standard on panic devices
Finishes	626, 689, 691, 693, 695
Options	Shim Kit #224, Sex Nuts and Bolts, Bottom Pullman Latch (panic only)
Warranty	1-year limited



Trim Designs

Escutcheons

420F Series



Projection: 2-13/32" (61mm)

Roses

440F Series



Projection: 3-1/2" (89mm)

Plate Trim

210F Series



Standard Levers

AU Augusta 	MO Monroe 	PB Pacific Beach 
 <p>Projection: 2-5/16" (59mm)</p>	 <p>Projection: 2-3/16" (71mm)</p>	 <p>Projection: 2-3/4" (70mm)</p>

Trim Designs



420F Series Wide Escutcheon Trim



- Certified ANSI/BHMA A156.3, Grade 1. **BHMA CERTIFIED**
- Through-bolted. 1-3/4" (44mm) door standard. For doors thru 2-1/4" (57mm) or shim-mounted devices, specify on order.
- Dimensions: 2-1/2" x 9-1/2" x 1/4" (64mm x 241mm x 6mm).
- Cylinders not included. For rim cylinders, see pages 15-16.
- Lever styles: AU, MO, PB
- Finishes: 630, 689, 691, 693, 695.
- 1-year warranty.
- Ordering Example: PB428F x LHR x 689.

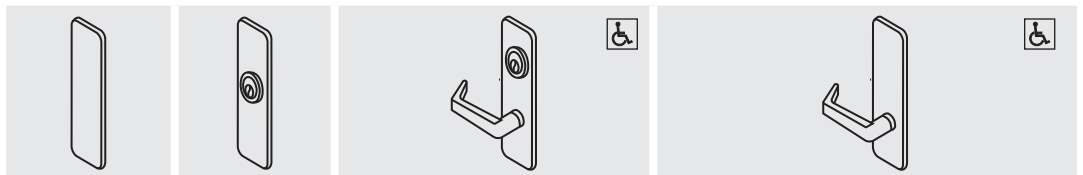

Application	Cylinder	Exit Only Blank Plate	Nightlatch	Classroom/Storeroom	Nightlatch	Dummy Free Wheeling	Passage	Dummy Rigid Lever
1800(F) 1810(F)	Rim	420F	421F*	426F	427F*	428F	428F	429F
ANSI		01	03	08/09	03	02	14	02

***Not recommended for use with 1810(F) surface vertical rod exit devices.**
Note: 09 and Free Wheeling 02 achieved with single trim modification at installation.

Trim Designs



440F Series Rose Trim



- Certified ANSI/BHMA A156.3, Grade 1. **BHMA CERTIFIED**
- 440F rose trim for stock doors (161 Prep).
- 1-3/4" (44mm) door standard. For doors thru 2-1/4" (57mm) or shim-mounted devices, specify on order.
- Cylinders included, accepts component cylinders. See pages 15-16.
- Finishes: 626, 689, 691, 693, 695.
- "B" trim prefix – Lever trim accepting small format interchangeable cores (SFIC). Specify 6- or 7-pin. (Example: B-AU446F)
- 2-year warranty.
- Ordering example: AU446F x RHR x 693.

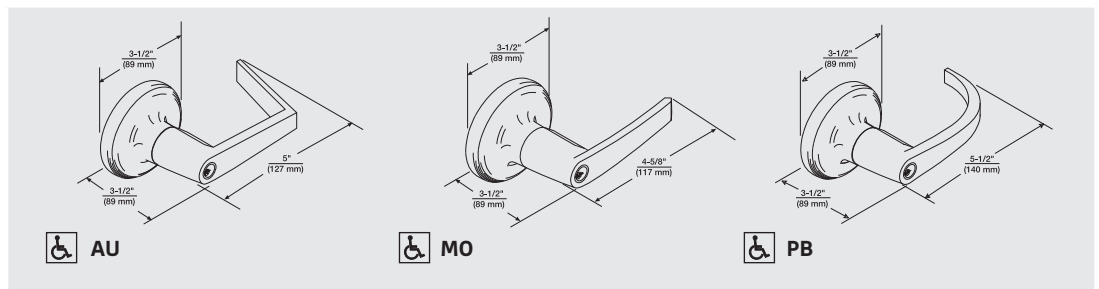

Application	Nightlatch Access by Key	Classroom	Dummy Trim Free Wheeling Lever	Passage Lever	Dummy Trim Rigid Lever
1800(F) 1810(F)	441F*	446F	448F	448F	449F
ANSI	03	08	02	14	02

*Not recommended for use with vertical rod exit devices.

Trim Designs



210F Series Trim



- Thrubolted. 1-3/4" (44mm) door standard. For doors thru 2-1/4" (57mm) or shim-mounted devices, specify on order.
- Plate Dimensions: 3-1/2" x 3-3/4" x 3/32" (89mm x 95mm x 2mm).
- Finger Pull Dimensions: 3-1/2" x 6-3/4" x 1/8" (89mm x 171mm x 3mm).
- Cylinders not included. For rim cylinder options, see pages 15-16.
- Finishes: 689, 691, 693, 695.
- 1-year warranty.

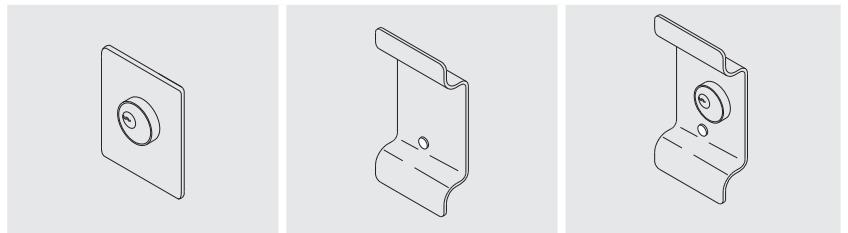













Application	Cylinder	Nightlatch Access by Key	Dummy Trim Pull Plate	Nightlatch Cylinder x Pull
1800(F) 1810(F)	Rim	213F*	214F	217F*
ANSI		03	02	03

***Not recommended for use with 1810(F) surface vertical rod exit devices.**

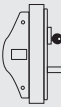
Functions







ANSI types 1 (Rim) and 2 (Surface Vertical Rod) exit device requirements are met (or exceeded) by 1800(F) and 1810(F) respectively. Any of these exit devices may be used with any of the trim on the following chart. Trims are charted according to ANSI trim function and illustrations show typical function features, rather than pictorial renderings of the trims listed. Specific trim details are shown on pages 9-12.

Trim	Device (ANSI)	Rim (Type 1)		SVR (Type 2)	
	Options	1800(F) (Page 7)		1810(F) (Page 8)	
ANSI	Function				
01	Exit Only, No Trim/Exit Only, Blank Plate		420F		420F
02	Pull to Open (Dummy Trim)		214F 448F* 428F* 449F* 429F		214F 448F* 428F* 449F* 429F
03	Key Retracts Latchbolts (NL)		213F 427F 217F 441F 421F		213F 427F 217F 441F 421F
08	Entrance by Lever (Key Locks/Unlocks Lever)		426F 446F		426F 446F
09	Key Unlocks Lever (Key Removable When Locked)		426F*		426F*
14	Lever Always Active (Passage)		428F 448F		428F 448F



***Trims marked with an asterisk on the Application Chart require an easy field change to adapt them for the charted function.**



Single Door	Pairs of Doors
 <p>Rim Exit Device</p> <ul style="list-style-type: none"> • ANSI/BHMA A156.3 Type 1 • Easy installation • Flush or wide stile metal, wood or composite doors • Non-handed • Exit only or with entry trim 	 <p>One Rim - One Vertical Rod Exit Device</p> <ul style="list-style-type: none"> • An economic solution for light traffic openings • Flush or wide stile metal, wood or composite doors • Non-handed • Emergency exit only
Pairs of Doors with Center Mullion	Pairs of Doors or Double Egress Opening
 <p>Two Rim Exit Devices - One Removable Mullion</p> <ul style="list-style-type: none"> • ANSI/BHMA A156.3 Type 1 and Type 22 • Easy installation • Flush or wide stile metal, wood or composite doors • Non-handed • Exit only or with entry trim 	 <p>Two Surface Vertical Rod Exit Devices</p> <ul style="list-style-type: none"> • ANSI/BHMA A156.3 Type 2 • Two-point latch security • Flush or wide stile metal, wood or composite doors • Smoke control or fire exits • Two-way traffic control

Cylinders

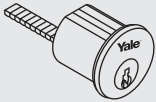
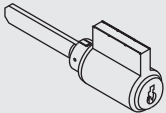

Illustration	Type	Model Number	Number of Pins
	Cylinder used for trim series 210F and 420F	1109	6
	Cylinder used for trim series 440F	1802	6
	Cylinder used for KRM200(F)	2153	6

Keying

All cylinders furnished standard 6-pin, keyed random in Yale® PARA keyway, pinned to Yale .019" specification. Each cylinder furnished with two nickel silver keys.

Options

Cylinders available 0-bitted, keyed alike, master keyed or construction master keyed upon request.



Small Format Interchangeable Core (SFIC)

Model/Prefix	Description	Length	Number of Pins (Specify)		Ordering Example
			6-Pin	7-Pin	
B-	Prefix for cylindrical lever with SFIC prep. Less core. For use with 440F series trim.	—	—	—	B-AU446F x 693
K680	Rim SFIC housing only. For use with 210F and 420F series trim.	1-1/4"	X	—	AU426F x K680 x 1-1/4" x 693
		1-3/8"	X	X	
K660	Mortise SFIC housing only. For use with Key Removable Mullion.	1-1/4"	X	—	KRM200F x K660 x 1-1/4"
		1-3/8"	X	X	

Cylinders

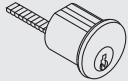
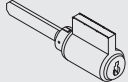
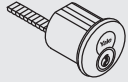

Competitor Keyway Cylinders/Cores

Illustration	Type	Model Number	Number of Pins
	Best® Keyway Core. Available keyed random, master keyed or uncombined. Specify keyway A, B, C, D, E, F, G, H, J, K, L or M.	A600	6 or 7
	Schlage® "C" Keyway Cylinder. For use with 210F and 420F series trim. Available 0-bitted or keyed random.	2109	6
	Schlage® "C" Keyway Cylinder. For use with 440F series trim. Available 0-bitted or keyed random.	2802	6
	Rim SFIC Cylinder. Includes Best Keyway Core. For use with 210F and 420F series trim. Available keyed random, master keyed or uncombined. Specify keyway A, B, C, D, E, F, G, H, J, K, L or M.	A640	6 or 7 Specify Length: 1-1/4" (6-pin only) 1-3/8" (6- or 7-pin)
	Mortise SFIC Cylinder. Includes Best® Keyway Core. For use with Key Removable Mullion. Available keyed random, master keyed or uncombined. Specify keyway A, B, C, D, E, F, G, H, J, K, L or M.	A620	6 or 7 Specify Length: 1-1/4" (6-pin only) 1-3/8" (6- or 7-pin)
	Schlage® "C" Keyway Cylinder. For use with Key Removable Mullion. Available 0-bitted or keyed random.	2553	6

Strikes



Rim Devices

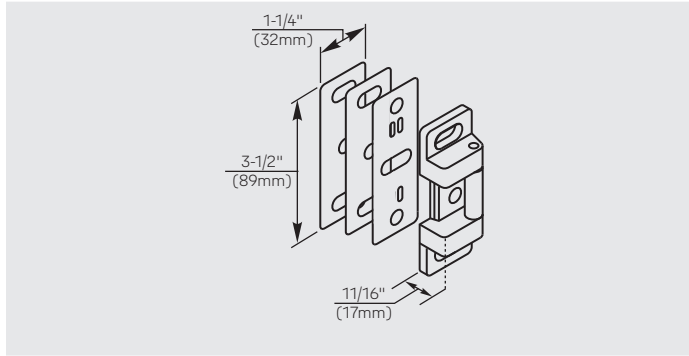

757F
Standard strike for 1800(F) devices. Supplied with #10-24 x 3/4" machine screws, two shims (each 1/16" thick), and one locking plate.

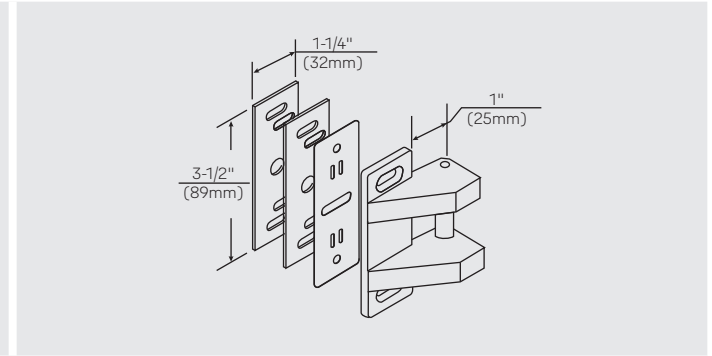

793
Optional strike for double door applications without a mullion. Supplied with #10-24 x 3/4" machine screws, two shims (each 1/16" thick), and one locking plate.

Vertical Rod Devices - Top Strikes

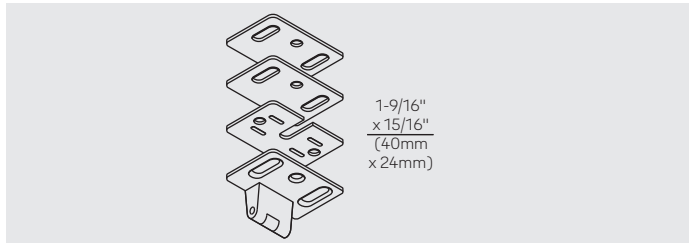

791
Standard top strike for 1810(F) devices. Supplied with #10-24 x 3/4" machine screws, two shims (each 1/16" thick), and one locking plate.

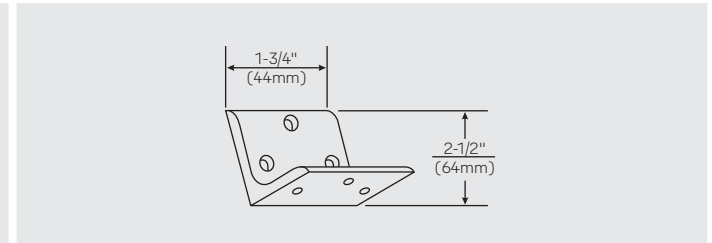

797
Optional bracket for mounting 791 top strike in flush transom opening. Supplied with 1/4-20 machine screws; SN-134 sex nuts, optional.

Vertical Rod Devices - Bottom Strikes

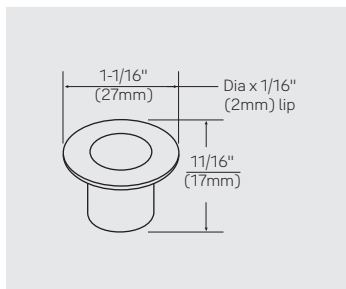

790
Standard bottom strike for 7110(F), 7120(F), 7160(F), 7170(F), 7210, 7220, 7210M(F), 7220M(F) series devices. Press in place.

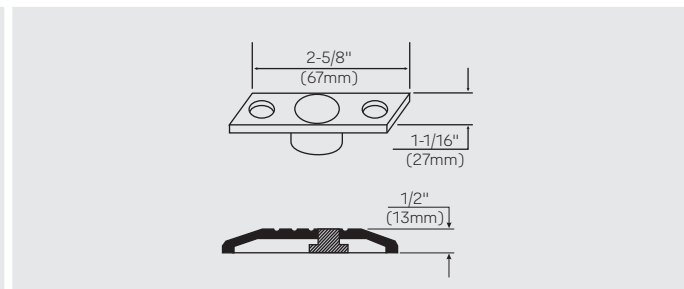

794
Optional bottom strike for fire openings using saddle thresholds or for flush floor mount. Must use for fire openings with 1/2" thresholds. Supplied with #10-24 x 1/2" machine screws and floor anchors.

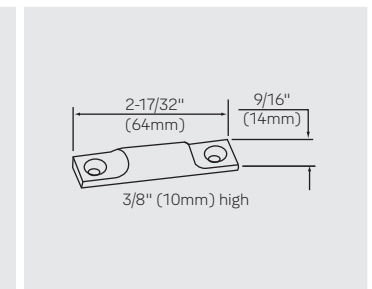

702
Optional bottom strike for bottom pullman latch option. Supplied with #8 x 8/32" combination screws.



Accessories

Shim Kits

Shim kits are available for devices on doors with interfacing – molding. Each shim kit contains:

- 2 sets of 1/8" shims (shim up to 1/4")
- Longer fasteners
- Longer connecting bar for the trim
- Installation instructions

223 – Shim Kit for 1800(F) Series rim exit devices

224 – Shim Kit for 1810(F) Series surface vertical rod exit devices

Extension Rods

1810(F) surface vertical rod devices are supplied standard for 7' (213cm) standard. Rods may be field cut or used with extension rods for other heights. To order, specify:

Model Number	Length
2010-2	2" (51mm)
2010-6	6" (153mm)
2010-12	12" (305mm)

Specialty Fasteners

Sex Nuts:

Required for wood, composite or unreinforced metal doors. To order specify:

- SN-104 – pack of (4) 10-24 sex nuts for all fire rim exits
- SN-134 – pack of (4) 1/4"-20 sex nuts for all devices

Wood Door Fasteners:

For solid core wood doors, permitted if pilot holes are used to install screws. Consult the factory for availability.

Torx® Security Screws available for factory product orders.

Long Tailpiece Kit

Long tailpiece kit for use with escutcheon series trim, up to 4-1/2" thick doors. Specify part number to order.

Door Thickness	Trim Type	Part Number
2" - 2-1/2"	420F Series Trim	81-9500-1665-000
2-1/2" - 3-1/2"	420F Series Trim	81-9500-1635-000
3-1/2" - 4-1/2"	420F Series Trim	81-9500-1636-000

Bottom Pullman Latch

Optional bottom Pullman latch available for panic-listed vertical rod exit devices. To order with devices, specify "BPL." 702 bottom strike required, see page 17.

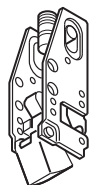

Mullions

M200(F) Removable Mullion

M200(F) steel mullions are for use with 1800(F) Series exit devices. Mullions may be field cut to fit opening. Red primer finish.

- M200 panic rated.
Tubular steel, 2" x 3" (51mm x 76mm). Specify 7', 8', or 10'.
- M200F 3 hour fire rated.
Tubular steel, 2" x 3" (51mm x 76mm). Specify 7' or 8'.

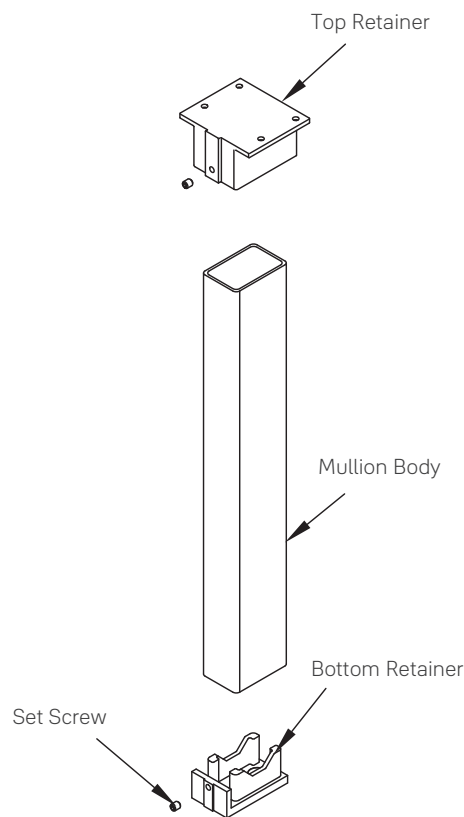

M200(F) Options

- **M203 Spacer Block**
Recommended for double rabbeted frames where the stop face width is less than the mounting hole spacing or for applications with 5-3/4" (146mm) or less door frames.

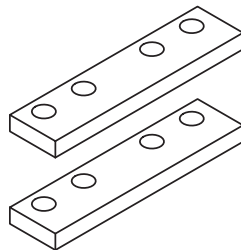

- **M204 Angle Bracket**
Recommended for any header configuration with less than 3" (76mm) of mounting surface.

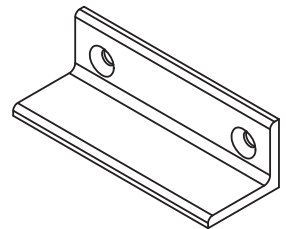



Mullions

Keyed Removable Mullion (KRM)

Keyed removable mullions are for use with 1800(F) series exit devices. They are designed for simple removing when an unobstructed large opening is required and easy replacement and locking to maintain the integrity of the opening.

- KRM200 panic rated. Specify 7', 8', or 10'.
- KRM200F 1-1/2 hour fire rated. Specify 7' or 8'.

KRM Features

- Easy cylinder installation.
- Mullion automatically relocks when reinstalled without the use of the cylinder key.
- When ordering, add KR prefix to mullion, example: KRM200 and KRM200F.

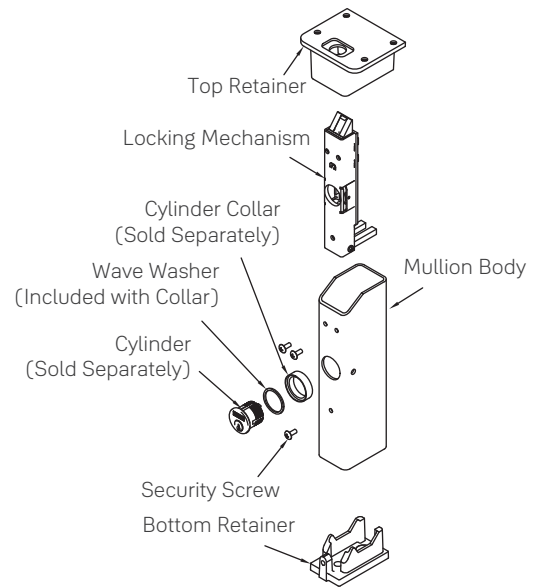

KRM Options

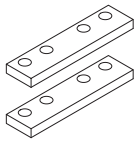

- **M203 Spacer Block**
Recommended for double rabbeted frames where the stop face width is less than the mounting hole spacing or for applications with 5-3/4" (146mm) or less door frames.

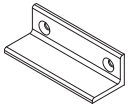

- **M204 Angle Bracket**
Recommended for any header configuration with less than 3" (76mm) of mounting surface.

KRM Cylinders

As with any exit device trim, you must order a cylinder and collar if one is required. The Yale® keyed removable mullion accepts a mortise cylinder. Refer below and to pages 15-16 for details.

KRM Collars

Cylinder Model #	Length	Collar Requirement
2153 or 2553	1-1/4"	1765.312
A620 or K660	1-1/4"	1765.406
	1-3/8"	1765.563



Dimensions

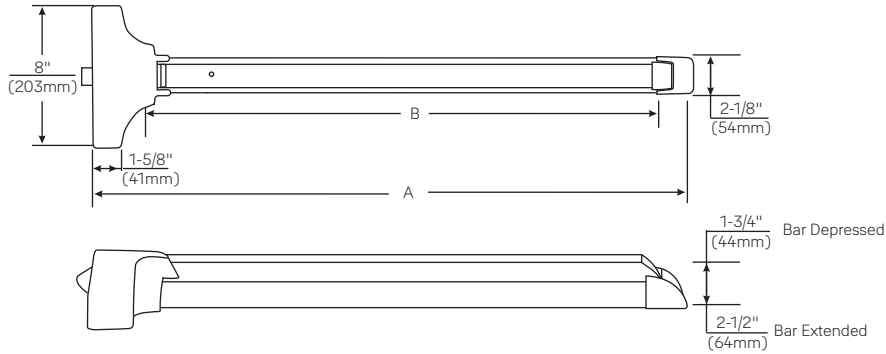

Device Size	"A"	"B"
36"	33" (84cm)	27" (69cm)
42"	39" (99cm)	33" (84cm)
48"	45" (114cm)	39" (99cm)

Technical Specifications & Listings



ANSI/BHMA

Certified ANSI/BHMA A156.3, Grade 1.



Fire Listings

1800 series exit devices are UL-cUL Listed for use on fire doors having a rating up to and including 3-hours.

Note: Any retrofit or other field modification to a fire rated opening can potentially impact the fire rating of the opening, and Yale Locks & Hardware makes no representations or warranties concerning what such impact may be in any specific situation. When retrofitting any portion of an existing fire rated opening, or specifying and installing a new fire-rated opening, please consult with a code specialist or local code official (Authority Having Jurisdiction) to ensure compliance with all applicable codes and ratings.

Free Wheeling Lever Trim

1800 series exit device lever trims feature the unique Free Wheeling lever mechanism. This Free Wheeling trim features a clutch mechanism which allows the lever to float down 60° when operated in the locked condition, greatly improving vandal resistance.

ISO 9001

Designed and manufactured under a certified ISO 9001 quality system.

Warranty

The 1800 series exit devices and escutcheon trim carry a three-year warranty. Cylindrical trims carry a two-year warranty.

Notes





Trusted every day

Phone

1-855-557-5078

Customer Service Email

customerservice.yale@assaabloy.com

Technical Product Support Email

techsupport.yale@assaabloy.com

Order Entry Email

orders.yaleus@assaabloy.com

Fax

1-800-338-0965

Website

www.yalecommercial.com

Contact Us

U.S.A.

Yale Locks & Hardware

Address: 225 Episcopal Road

Berlin, CT 06037-4004

Tel: 1-800-438-1951

Fax: 1-800-338-0965

yalecommercial.com

Canada:

ASSA ABLOY Door Security Solutions Canada

Address: 160 Four Valley Drive

Vaughan, Ontario L4K 4T9

Tel: 1-800-461-3007

Fax: 1-800-461-8989

assaabloydss.ca

International:

ASSA ABLOY Americas International

Tel: 1-905-821-7775

Fax: 1-905-821-1429

assaabloyai.com

MicroShield®

ASSA ABLOY Group companies offer MicroShield®, an anti-microbial coating for door hardware. MicroShield uses proven silver ion-based technology from Agion®, a leading provider of antimicrobial solutions, to stem the spread of bacteria and other microbes.

MicroShield® is a registered trademark of ASSA ABLOY Access and Egress Hardware Group, Inc.



Nature's antimicrobial

The Agion antimicrobial is not intended as a substitute for good hygiene. Coated products must still be cleaned to ensure the surfaces will be free of destructive microbes. ASSA ABLOY makes no representations or warranties, express or implied, as to the efficacy of the Agion antimicrobial. A copy of the Agion warranty is available upon request. Agion is a registered trademark of Agion Technologies, Inc., Wakefield, MA, USA.

THE YALE BRAND, with its unparalleled global reach and range of products, reassures more people in more countries than any other consumer locking solution.

THE ASSA ABLOY GROUP is the world's leading manufacturer and supplier of locking solutions, dedicated to satisfying end-user needs for security, safety and convenience.

Yale Commercial is a business associated with ASSA ABLOY Access and Egress Hardware Group, Inc., an ASSA ABLOY Group company. Copyright © 2010-2021, ASSA ABLOY Access and Egress Hardware Group, Inc. All rights reserved. Reproduction in whole or in part without the express written permission of ASSA ABLOY Access and Egress Hardware Group, Inc. is prohibited. Patent pending and/or patent www.assaabloydss.com/patents.



1500 Series Traditional Exit Devices



Table of Contents



Contents

Introduction.....	3
Benefits & Features.....	4
Finishes.....	5
How to Order.....	6
1500(F) Rim.....	7
1510(F) Surface Vertical Rod.....	8
1520(F) Concealed Vertical Rod.....	9
1530(F) Mortise.....	10
Trim Designs.....	11-12
Exit Device Trims.....	13-14
Applications Chart.....	15
Applications.....	16-17
Cylinders.....	18-20
Strikes.....	21
Accessories.....	22
Mullions.....	23-24
Technical Specifications & Listings.....	25

1500 Traditional Exit Devices

1500 Series Traditional Exit Devices are the perfect solution for modern retrofit applications that require maintaining the look and integrity of historic architectural motifs. Available with a variety of trims and options, the 1500 Series is able to suit a range of decor and application requirements.



Recapturing vintage aesthetics with security for a modern world, Yale Works for YouSM.

Introduction



Yale® Commercial Solutions offers innovative and reliable products to solve the challenges of commercial, retail, hospitality, assisted living, mixed-use, and multi-family properties. With over 150 years of door hardware experience, Yale's expertise extends beyond products to people - and provides the service and support you expect.

Featuring durable products to meet all your facilities' requirements - and the quality you expect from a leader in the hardware industry. Yale Works for YouSM.

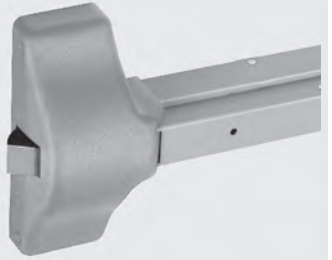
Yale Exit Devices			
7000 Series	6000 Series	2100 Series	1800 Series
			
<ul style="list-style-type: none"> • Ideal for facilities that require durability and innovation to meet their security needs • Wide & Narrow Stile Applications • Rim, SquareBolt, Mortise, SVR & CVR • Mechanical & Electro-Mechanical Functions • Available with Motorized Electric Latch Retraction • Constructed with high quality steel and heavy-duty components • 16 Standard finishes including BSP (Black Suede Powder Coat) • UL Rated for Panic & Fire • ANSI/BHMA Certified Grade 1 • 5 Year Warranty and Two-Year Limited Warranty on Electronic Components • UL Rated for Panic & Fire, Windstorm Rated Options (refer to local codes) 	<ul style="list-style-type: none"> • Ideal for facilities that require modern form and full functionality to meet their life safety needs • Wide & Narrow Stile Applications • Rim, Squarebolt, CVR, SVR & Mortise • Mechanical & Electro-Mechanical Functions • Aluminum rail assembly with Architectural Metals • Solid Cast Flush End Cap • ANSI/BHMA Certified Grade 1 • UL Rated for Panic & Fire • 10 Year Warranty 	<ul style="list-style-type: none"> • Ideal for commercial applications and budget conscious end users • Narrow & Wide Stile Applications • Rim, Squarebolt, CVR & SVR • Mechanical Functions • ANSI/BHMA Grade 1 Certified • UL Rated for Panic & Fire • Architectural & Painted Finishes • 3 Year Warranty 	<ul style="list-style-type: none"> • Ideal for back of the house where function and code compliance are the requirement • Wide Stile Applications • Rim & SVR • Mechanical Functions • ANSI/BHMA Certified Grade 1 • UL Rated for Panic & Fire • Powder-coat Painted Finishes • 1 Year Warranty



Benefits

- **Great for retrofit applications:** Classic design allows for upgrade in historic buildings, on single or pairs of doors
- **Easy installation:**
- **Strong & reliable:** ANSI/BHMA Grade 1 certified for long life and durability

Features

- Available in rim, mortise, surface vertical rod and concealed vertical rod
- Lever, handle and pull trim designs available for design continuity throughout a building
- 2-point hex-key dogging for standard devices enables quiet push-pull door operation during peak traffic hours
- Standard outside trim available with a choice of Yale 6 and 7-pin, interchangeable core, patented and security rim cylinders, keyed as needed



Finishes



ANSI/BHMA Code Finish Description			
605 Bright Brass, Clear Coated	606 Satin Brass, Clear Coated	609¹ Satin Brass, Blackened, Satin Relieved, Clear Coated	611 Bright Bronze, Clear Coated
612 Satin Bronze, Clear Coated	613E Dark Oxidized Satin Bronze - equivalent	616 Satin Bronze, Blackened, and Satin Relieved, Clear Coated	619* Satin Nickel Plated, Clear Coated
620 Satin Nickel Plated, Blackened, Satin Relieved, Clear Coated	626* Satin Chrome Plated	629 Bright Stainless Steel	630* Satin Stainless Steel
693 Black Painted	695 Dark Bronze Painted	BSP Black Suede Powder Coat	WSP White Suede Powder Coat

1. These finishes will be provided per factory standard. To assure color match, please provide a sample.

*Finish available with MicroShield® antimicrobial coating, additional finishes by special application. Consult factory for availability.

MicroShield coating may vary finish color from architectural standards. MicroShield is not intended as a substitute for traditional infection control programs such as hand hygiene or use of disinfectants. Coated products must still be cleaned to ensure the surfaces will be free of destructive microbes. Yale makes no representations or warranties, express or implied, as to the efficacy of MicroShield.

How to Order



The following selection guide indicates the correct cylinder for each locking segment.

Quantity	X	0	Suffix	Size	Design	Trim	Finish	Other Info
15	Third Position: 0 - Rim Device 1 - SVR Device 2 - CVR Device 3 - Mortise Device		Suffix - Mechanical Feature: "F" - Fire Exit Device "L5" - Mortise Device, Entry by Key with/without Rigid Lever. Mortise Device E0 or entry by key. "L8" - Mortise Device, Entry by Lever. "T5" - Mortise Device with Thumbpiece Trim "T8" - Mortise Device, Active Thumbpiece Trim.	Size: (DOW = Door Opening Width) "36" - Thru 36" (90cm) "48" - Thru 48" (120cm)	Trim Design: (Lever only.)	Trim Model Number	Finish Code: See Page 5	Other Information: Door Hand - All devices and lever handle trim. Door Thickness - over 1-3/4" (45mm). Fastener Options - Torx® Security Screws, SNB (wood, composite, or unreinforced metal doors). Specialty Cylinders & Components

Packaging

It is recommended that exit devices and trim for the same opening be ordered together. Standard product are for 1-3/4" (44mm) reinforced metal doors. Accessories detached from the device and trim should be specified separately. Materials by others are required to be fit for the purpose as detailed in this catalog and the product installation literature.

1500(F) Rim



The 1500(F) is a traditional exit device for single swing doors or pairs of doors with mullions of metal, wood or composite construction.



Certification/Compliance

UL/cUL Listed: FVSR/FVSR7 - Panic hardware
GXHX/GXHX7 - Fire exit hardware (F)
(4' x 8' single, 8' x 8' pairs, 3 hr.)

ANSI/BHMA Certified: A156.3 Type 1, Grade 1 

Features

- Designed for wide stile doors
- Handed, specify hand (field reversible)

Applications

- Single swing doors
- Pairs of doors with removable mullions
- Metal, wood or composite door materials

Specifications

Door Opening Width	-36 for 30" - 36" (76cm - 91cm) doors -48 for 36" - 48" (91cm - 122cm) doors
Door Thickness	1-3/4" (44mm) standard
Minimum Stile Width	4-1/2" (114mm)
Projection	5-5/8" (143mm) active, 4-1/2" (114mm) depressed.
Latchbolt	3/4" (19mm) deadlocking stainless steel pullman-type
Strike	799 (panic & fire), 793 optional (double door application)
Fasteners	Machine screws and wood door fasteners standard for panic hardware. Sex nuts and bolts supplied standard for fire exit hardware.
Trims	620F series escutcheon trim, 630F series pull/thumbpiece trim. See pages 13-14.
Dogging	Hex key dogging supplied standard on panic devices
Options	Sex nuts and bolts
Warranty	1-year limited

1510(F) Surface Vertical Rod



The 1510(F) is a traditional surface vertical rod exit device for any door where two-point latching is desired (inactive doors of pairs in particular).

Packed for 7'0" high (2.13m) openings with recommended template. Field cut rods or use rod extensions for other applications.

Certification/Compliance

UL/cUL Listed: FVSR/FVSR7 - Panic hardware
GXHX/GXHX7 - Fire exit hardware (F)
(8' x 8' pairs, 3 hr.)

ANSI/BHMA
Certified: A156.3 Type 2, Grade 1



Features

- Designed for wide stile doors
- Handed, specify hand (field reversible)
- Positive action linkage on a deadlocking top pullman bolt
- Simultaneous direct pull bottom deadbolt
- When unlatched, device keeps both bolts retracted until door is shut

Applications

- Pairs of doors
- Double egress
- Metal, wood or composite door materials

Specifications

Door Opening Width	-36 for 30" - 36" (76cm - 91cm) doors -48 for 36" - 48" (91cm - 122cm) doors
Door Opening Height	Standard door height 7' (213cm), with the device centerline at 39-5/16" (100cm) from floor. Optional heights up to 8' (fire) and 10' (panic) available by using rod extensions.
Door Thickness	1-3/4" (44mm) standard
Minimum Stile Width	4-1/2" (114mm)
Projection	5-5/8" (143mm) active, 4-1/2" (114mm) depressed.
Latchbolt	Top: 3/4" (19mm) throw, pullman-type with automatic deadlatching Bottom: 5/8" (16mm) throw deadbolt, held retracted during door swing
Vertical Rods	1/2" (13mm) O.D. tubular brass, bronze or stainless steel with rod guides
Strike	Top: Roller type 791. Bottom: Flush mounted 790. 794 floor strike optional (threshold openings), 702 floor strike optional (BPL devices).
Fasteners	Machine screws and wood door fasteners standard for panic hardware. Sex nuts and bolts supplied standard for fire exit hardware.
Trims	620F series escutcheon trim, 630F series pull/thumbpiece trim. See pages 13-14.
Dogging	Hex key dogging supplied standard on panic devices
Options	Sex nuts and bolts, bottom pullman latch (panic only), rod extensions
Warranty	1-year limited

1520(F) Concealed Vertical Rod



The 1520(F) is a traditional concealed vertical rod exit device for metal doors where two-point latching is desired (inactive doors of pairs in particular.)

Certification/Compliance

UL/cUL Listed: FVSR/FVSR7 - Panic hardware
GXHX/GXHX7 - Fire exit hardware (F)
(8' x 8' pairs, 3 hr.)

ANSI/BHMA
Certified: A156.3 Grade 1, Type 8, Grade 1



Features

- Designed for wide stile doors
- Handed, specify hand (field reversible)
- Positive action linkage on a deadlocking top pullman bolt
- Simultaneous direct pull bottom deadbolt
- When unlatched, device keeps both bolts retracted until door is shut

Applications

- Pairs of doors
- Double egress
- Metal doors only

Specifications

Door Opening Width	-36 for 30" - 36" (76cm - 91cm) doors -48 for 36" - 48" (91cm - 122cm) doors
Door Opening Height	Standard door height adjustable to 8' (244cm). Optional heights up to 10' (panic) available by using rod extensions.
Door Thickness	1-3/4" (44mm) standard
Minimum Stile Width	4-1/2" (114mm)
Projection	5-5/8" (143mm) active, 4-1/2" (114mm) depressed.
Latchbolt	Top: 3/4" (19mm) throw, pullman-type with automatic deadlatching Bottom: 5/8" (16mm) throw deadbolt, held retracted during door swing
Vertical Rods	1/2" (13mm) O.D. telescoping tubular rods
Strike	Top: Roller type 791. Bottom: Flush mounted 790. 794 floor strike optional (threshold openings)
Fasteners	Machine screws and wood door fasteners standard for panic hardware. Sex nuts and bolts supplied standard for fire exit hardware.
Trims	620F series escutcheon trim, 630F series pull/thumbpiece trim. See pages 13-14.
Dogging	Hex key dogging supplied standard on panic devices
Options	Sex nuts and bolts, rod extensions
Warranty	1-year limited

1530(F) Mortise



The 1530(F) is a traditional exit device integrated with Yale 8700 series mortise lock for the active leaf of pairs and single doors where both exit device and security are required. Can be installed on metal, wood or composite doors. The 8700 series mortise lock used is modified for use with exit devices only.

Certification/Compliance

UL/cUL Listed: FVSR/FVSR7 - Panic hardware
 GXHX/GXHX7 - Fire exit hardware (F)
 (4' x 8' single, 8' x 8' pairs, 3 hr.)
 (4' x 9' single, 8' x 9' pairs, 1-1/2 hr.)

ANSI/BHMA
 Certified:

A156.3 Type 3, Grade 1



Features

- Designed for wide stile and flush doors
- Handed; specify hand
- Two-piece mechanical 3/4" throw deadlocking stainless steel latchbolt

Applications

- Single swing doors
- Pairs of doors with vertical rod devices or automatic flush bolts
- Metal, wood or compatible door materials

Order as follows, according to function.















1530-K5(F)	(01) Exit only. (02) Entry by pull when dogged. (03) Key retracts latchbolt.
1530-L5(F)	(02) Entry by rigid lever when dogged. (03) Key retracts latchbolt.
1530-T5(F)	(02) Entry by pull when dogged. (03) Key retracts latchbolt.
1530-L8(F)	(08) Entry by lever lock/unlocked by key or lever only (passage).
1530-T8(F)	(05) Entry by thumbpiece lock/unlocked by key or thumbpiece only (passage).

Specifications

Door Opening Width	-36 for 30" - 36" (76cm - 91cm) doors -48 for 36" - 48" (91cm - 122cm) doors
Door Thickness	1-3/4" (44mm) standard. 2" and 2-1/4" (51mm and 57mm) optional; specify when ordering.
Minimum Stile Width	4-1/2" (114mm)
Projection	5-5/8" (143mm) active, 4-1/2" (114mm) depressed.
Latchbolt	Two piece mechanical 3/4" (19mm) deadlocking stainless steel with anti-friction insert and auxiliary deadlocking latch
Strike	798 curved lip, non-handed standard. 712 optional for door pairs with astragals. 718 optional open back strike.
Fasteners	Machine screws and wood door fasteners standard for panic hardware. Sex nuts and bolts supplied standard for fire exit hardware.
Trims	350F/620F/650F series escutcheon trim, 630F/660F/670F series pull/thumbpiece trim. See pages 13-14.
Dogging	Hex key dogging supplied standard on panic devices
Options	Sex nuts and bolts
Warranty	1-year limited



Standard



































<p>Arcadia AR</p>  <p>Projection: 3-1/4" (82mm)</p>	<p>Augusta AU</p>  <p>Projection: 2-5/8" (61mm)</p>	<p>Carmel CR</p>  <p>Projection: 3-1/8" (79mm)</p>
<p>Jefferson JN </p>  <p>Projection: 2-9/16" (65mm)</p>	<p>Monroe MO </p>  <p>Projection: 3" (76mm)</p>	<p>Pacific Beach PB </p>  <p>Projection: 3-5/16" (84mm)</p>
<p>Pinehurst PN </p>  <p>Projection: 3-1/16" (78mm)</p>	<p>Virginia VI </p>  <p>Projection: 3-1/8" (79mm)</p>	<p>Hampton HA </p>  <p>Projection: 3-3/8" (86mm)</p>

Note: Projection dimensions are provided using the 620F series escutcheon plates.



Reflections® Levers



Hudson	TB  Projection 3-1/16" (78mm)	UB  Projection 3-1/4" (83mm)	TC  Projection 3" (76mm)	TD  Projection 3-7/16" (87mm)	UC  Projection 3-7/16" (87mm)	
Spree	RS  Projection 3-1/8" (79mm)	RT  Projection 3-1/8" (79mm)	RU  Projection 3-13/32" (87mm)	RV  Projection 3" (76mm)		
Seine	TE  Projection 3" (76mm)	TG  Projection 2-13/16" (61mm)	TI  Projection 3-3/8" (85mm)	TO  Projection 3-1/2" (89mm)	TJ  Projection 3-1/16" (78mm)	TK  Projection 3-1/4" (83mm)
Thames	TM  Projection 3-1/16" (78mm)	TN  Projection 3-1/16" (78mm)	TP  Projection 3-5/16" (84mm)	TR  Projection 3-1/16" (78mm)	TS  Projection 3-1/8" (80mm)	TQ  Projection 3-1/16" (78mm)
Victoria	TT  Projection 2-11/16" (68mm)	TU  Projection 3-1/4" (83mm)	TV  Projection 3-1/2" (89mm)	TW  Projection 3" (76mm)	UW  Projection 3-7/16" (87mm)	TX  Projection 3-5/8" (92mm)
Victoria, continued	UX  Projection 3-7/16" (87mm)	TY  Projection 3-5/16" (84mm)	TZ  Projection 3-7/16" (87mm)			
Niagara	MA  Projection 2-13/16" (71mm)	RA  Projection 3-11/16" (94mm)	RB  Projection 2-13/16" (71mm)	RC  Projection 2-13/16" (71mm)		

Note: Projection dimensions are provided using the 620F Series escutcheon plates.

Note: The following Reflections levers are not available in 629 or 630 finish: Victoria TT, TU, TV, TW, TX, TY, UW, UX, TZ; Seine TG, TJ, TK, TO, TE, TI; Hudson TD. Please consider the 618 or 619 finish as an alternative. Reflections levers are not available with knurling option.



Exit Device Trims

Rim and vertical rod devices use Universal Lifter Assembly #60-1500-0671-000, to connect to any 620 or 630 Series active trim. Mortise devices are supplied according to trim type and function desired. There is a 1530(F) Series device adequate for each 350, 650, 660 or 670 Series Trim charted.

350F, 620F and 650F Series Escutcheon Trim

- Certified ANSI/BHMA A156.3, Grade 1.
- Trim through-bolts to exit device for strength.
- Beveled sides improve attack resistance.
- Solid forged/cast escutcheon and free-wheeling trim for ideal protection.
- Flush cylinder in 6-pin applications for additional security.
- 1-3/4" (44mm) door standard. For doors through 2-1/4" (57mm) or shim-mounted devices, specify on order.
- Dimensions: 3" x 10-1/4" x 13/16" (76mm x 260mm x 19mm).
- Cylinders not included. See page 18-20 for cylinder options.
- Available with AR, AU, CR, JN, MO, PB, PN, VI, HA lever designs. See page 11.
 - Finishes: 605, 606, 609, 611, 612, 613, 613E, 616, 619, 620, 626, 629, 630, 693, 722, BSP
- Available with Reflections® lever designs. See page 12.
 - Finishes: 605, 606, 611, 612, 613, 613E, 619, 626, 629, 630, 722, BSP
- Trim ordering example: AU626F x 626 x RHR.
- 5-year limited warranty.

Application	Cylinder	Classroom/ Storeroom Cylinder Controls Thumbturn	Exit Only Blank Plate	Nightlatch Access by Key	Classroom Cylinder Controls Lever	Storeroom Cylinder Controls Lever	Nightlatch Cylinder by Lever	Passage	Dummy Trim Free- Wheeling	Dummy Rigid Lever
1500(F) 1510(F) 1520(F)	Rim	603F*	620F	621F^	626F	626F*	627F^	628F	628F*	629F
1530(F)	Mortise	--	620F	651F	356F	--	--	358F	--	358F
ANSI		11/12	01	03	08	09	03	14	02	02

***09,12 and Free Wheeling 02 achieved with single trim modification at installation.**

^Not recommended for use with vertical rod exit devices.

For 626, 629 & 630 finishes the escutcheon is plated to simulate stainless steel.

For 629 & 630 finishes the standard levers are plated to simulate stainless steel.

Exit Device Trims



630F, 660F and 670F Series Pull/Thumbpiece Trim

- Certified ANSI/BHMA A156.3, Grade 1.
- Trim through-bolts to exit device for strength.
- Beveled sides improve attack resistance.
- Flush cylinder in 6-pin applications for additional security.
- 1-3/4" (44mm) door standard. For doors through 2-1/4" (57mm) or shim-mounted devices, specify on order.
- Plate Dimensions: 2-3/4" x 15-1/2" x 5/8" (70mm x 394mm x 16mm).
- Pull Dimensions: 6-7/16" (164mm) on centers x 2-1/8" (54mm) projection.
- Cylinders not included. See page 18-20 for cylinder options.
- Finishes: 605, 606, 609, 612, 613, 613E, 616, 619, 620, 626, 629, 630, 693, 722, BSP
- Trim ordering example: 630F x 630
- 5-year limited warranty.





































Applications	Cylinder	Exit Only Blank Plate	Nightlatch Access by Key	Nightlatch Cylinder by Pull	Classroom Cylinder Controls T-Piece	Storeroom Cylinder Controls T-Piece	Dummy Trim Pull Plate	Passage Active T-Piece
1500(F) 1510(F) 1520(F)	Rim	630F	631F^	632F^	633F	633F*	634F	635F
1530(F)	Mortise	630F	661F	662F	673F	--	634F	675F
ANSI		01	03	03	05	06	02	15

*06 achieved with single trim modification at installation.
 ^Not recommended for use with vertical rod exit devices.
 For 626, 629 & 630 finishes the escutcheon is plated to simulate stainless steel.



Applications Chart



Trim	Device (ANSI)	Rim (Type 1)	SVR (Type 2)	CVR (Type 8)	Mortise (Type 3)
	Options	1500(F) See page 7	1510(F) See page 8	1520(F) See page 9	1530(F) See page 10
ANSI	Function	Trim Options	Trim Options	Trim Options	Trim Options
01	Exit Only (Blank Plate)	 620F 630F	 620F 630F	 620F 630F	 620F 630F
02	Pull to Open (Dummy Trim)	 625F, 629F ² 634F ²	 625F, 629F ² 634F ²	 625F, 629F ² 634F ²	 358F ² , 634F ² 654F
03	Entrance by Key & Pull (NL)	 621F, 623F 627F ² , 631F 632F ²	 621F, 623F 627F ² , 631F 632F ²	 621F, 623F 627F ² , 631F 632F ²	 356F ² , 651F 661F, 662F ²
05	Cylinder Controls Thumbpiece	 633F	 633F	 633F	 673F
—	Thumbpiece Always Active (Passage)	 635F	 635F	 635F	 675F
06	Key & Thumbpiece (Key Removable When Locked)	 633F ¹	 633F ¹	 633F ¹	
08L	Cylinder Controls Lever	 626F ²	 626F ²	 626F ²	 356F ²
—	Lever Always Active (Passage)	 628F ²	 628F ²	 628F ²	 358F ²
09L	Key & Lever (Key Removable When Locked)	 626F ^{1,2}	 626F ^{1,2}	 626F ^{1,2}	
11	Cylinder Controls Thumbturn				
12	Key & Thumbturn (Key Removable When Locked)				

1 Field conversion required.

2 ADA compliant trim.



Single Door



Rim Exit Device - Standard Opening

- ANSI/BHMA A156.3 Type 1
- Easy installation
- Flush or wide stile metal, wood or composite doors
- Field reversible
- Exit only or with entry trim

Exit Device	Panic Exit: 1500
	Fire Exit: 1500F
Operating Trim	620F or 630F Series
Ordering Example	1500-36" x AU626F x RHR x 626

Mortise Exit Device - Mortise Lock Retrofit

- ANSI/BHMA A156.115, (ASA86) prep door
- Flush or wide stile metal, wood, or composite doors
- Mortise lock security with an exit device

Exit Device	Panic Exit: 1530
	Fire Exit: 1530F
Operating Trim	350F, 650F, 660F, 670F Series
Ordering Example	1530-L8-36" x AU356F x RHR x 612

Double Egress Opening

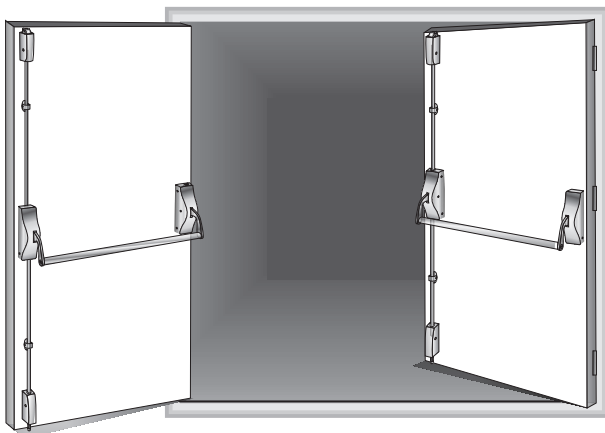

Two Surface Vertical Rod Exit Devices

- ANSI/BHMA A156.3, Type 2
- Two-point latch security
- Flush or wide stile metal, wood or composite doors
- Field reversible
- Smoke control or fire exit
- Two-way traffic control

Exit Device	Panic Exit: (2) 1510
	Fire Exit: (2) 1510F
Operating Trim	620F or 630F Series
Ordering Example	2 each: 1510F-48" x LHR x 626

Two Concealed Vertical Rod Exit Devices

- ANSI/BHMA A156.3, Type 8
- No exposed rods or latchbolts
- ADA compliant
- Flush or wide stile metal doors
- Field reversible
- Smoke control or fire exit
- Two-way traffic control

Exit Device	Panic Exit: (2) 1520
	Fire Exit: (2) 1520F
Operating Trim	620F or 630F Series
Ordering Example	2 each: 1520F x 633F x LHR x 630



Pair Of Doors With Center Mullion



Two Rim Exit Devices - One Removable Mullion

- ANSI/BHMA A156.3
- Type 1
- Easy installation
- Flush or wide stile metal, wood or composite doors
- Exit only or with entry trim
- Recommended for easier traffic flow.

Exit Device	Panic Exit: (2) 1500 x M200
	Fire Exit: (2) 1500F x M200F
Operating Trim	620F or 630F Series
Ordering Example	2 each: 1500-36" x AU626F x 1/2RHR x M200-7'0" x 626

Pair Of Doors Without Mullion

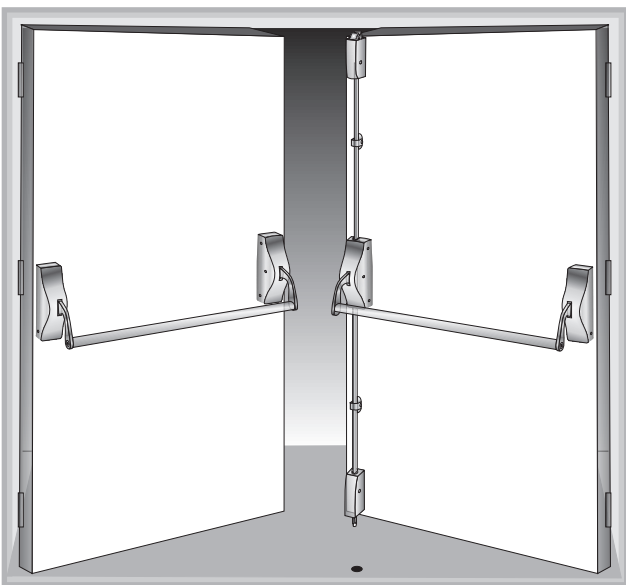

One Mortise - One Vertical Rod Exit Device

- The architectural choice for pairs of doors without mullions
- Flush or wide stile metal, wood or composite doors
- Panic or fire label openings

Exit Device	Panic Exit: 1530 Mortise x 1520 (CVR) or 1510 (SVR)
	Fire Exit: 1530F Mortise x 1520F (CVR) or 1510F (SVR)
Operating Trim	630F, 650F, 660F or 670F Series (Active) x 620F or 630F Series (Dummy or Active)
Ordering Example	1 each: 1530-L8F x AU356F x RHR x 605, plus 1 each 1510F x AU629F x LHR x 605

One Rim - One Vertical Rod Exit Device

- An economic solution for light traffic openings
- Flush or wide stile metal, wood or composite doors

Exit Device	Panic Exit: 1500 Rim x 1510 SVR
Operating Trim	620F or 630F Series
Ordering Example	1 each: 1500-48" x RHR x 632F x 793 x 1510-48" x LHR x 634F x 626

Cylinders



Rim

The following chart details rim cylinders for use with 620F and 630F trims:

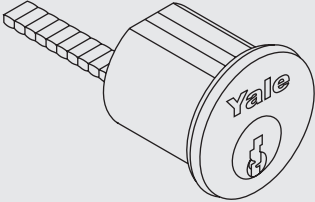
				Collar Requirements*	
				620F	630F
Model #	Description	Pins	Length	620F	630F
1109	Standard Fixed Core	6	1-1/4"	No Collar	No Collar
1109	Standard Fixed Core	7	1-7/16"		KP4
1709	CMK	6	1-15/16"	1765.250	1765.250
1709	CMK	7	1-5/8"		1765.406
1193	LFIC Complete	6	1-7/16"		1765.250
1193	LFIC Complete	7	1-5/8"	1765.344	1765.406
5109	Security Fixed Core	6	1-9/16"	No Collar	1765.250
5109	Security Fixed Core	7	1-7/16"		No Collar
U5109	High Security Fixed Core	6	1"		No Collar
U5109	High Security Fixed Core	7	1"		No Collar
5193	Security LFIC Complete	6	1-7/16"	1765.250	1765.250
5193	Security LFIC Complete	7	1-5/8"	1765.344	1765.406
K300	Yale® KeyMark® Standard Fixed Core	6	1-1/8"	KP4	1765.250
K300	Yale KeyMark Standard Fixed Core	7			
K840/ K880	Yale KeyMark LFIC Complete / Housing Only	6	1-7/16"	1765.406	1765.500
K840/ K880	Yale KeyMark LFIC Complete / Housing Only	7	1-5/8"	1765.563	1765.719
K640/ K680	Yale KeyMark SFIC Complete / Housing Only	6	1-1/4"	KP4	1765.250
K640/ K680	Yale KeyMark SFIC Complete / Housing Only	6 or 7	1-3/8"	1765.187	1765.406
A640/ K680	Best® Keyway SFIC Complete / Housing Only	6	1-1/4"	KP4	1765.250
A640/ K680	Best® Keyway SFIC Complete / Housing Only	6 or 7	1-3/8"	1765.187	1765.406
2109	Schlage® "C" Keyway Fixed Core. Available 0-bitted or keyed random.	6	1-1/8"	No Collar	No Collar

*Based on 1-3/4" door thickness. Collar length required must be specified for cylinders and/or housings ordered separately.

LFIC = Large Format Interchangeable Core

SFIC = Small Format Interchangeable Core

Cylinders



Mortise

The following chart details mortise cylinders for use with 350F/650F, 660F/670F, and KRM200 mullions:

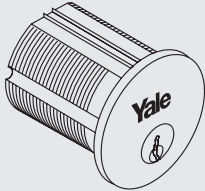
				350F/650F		660F/670F		KRM 200							
				Cam	Collar	Cam	Collar	Length	Cam	Collar					
Model #	Description	Pins	Length	Cam	Collar	Cam	Collar	Length	Cam	Collar					
2153	Standard Fixed Core	6	1-1/2"	2160	No Collar	2160	KP4	1-1/8"	2160	1765.312					
2153	Standard Fixed Core	7	1-1/2"					1-1/4"		1765.500					
2196	LFIC Complete	6	1-1/2"					1-1/2"		1765.750					
2197	LFIC Complete	7	1-11/16"					1765.250		1-11/16"	1765.844				
5153	Security Fixed Core	6	1-1/2"					1-1/8"		1765.312					
5153	Security Fixed Core	7	1-1/2"					1-1/4"		1765.500					
U5153	High Security Fixed Core	6	1-1/8"					NA		NA	NA	NA			
U5153	High Security Fixed Core	7	1-1/4"					NA		NA	NA	NA			
5196	Security LFIC Complete	6	1-1/2"					No Collar		KP4	1-1/2"	1765.750			
5197	Security LFIC Complete	7	1-11/16"					KP4		1765.250	1-11/16"	1765.844			
K100	Yale® KeyMark® Standard Fixed Core	6 or 7	1-1/2"					KC1		No Collar	KC1	KP4	1-1/8"	KC1	1765.312
K100	Yale KeyMark Standard Fixed Core	6 or 7	1-3/4"					Riveted		KP4	Riveted	1765.375
K820/ K860	Yale KeyMark LFIC Complete / Housing Only	6	1-1/2"	KC1	No Collar	KC1	KP4	1-1/2"	KC1	1765.750					
K820/ K860	Yale KeyMark LFIC Complete / Housing Only	7	1-11/16"		KP4		1765.375	1-11/16"		1765.000					
K620/ K660	Yale KeyMark SFIC Complete / Housing Only	6	1-1/4"		NA		NA	1-1/4"		1765.500					
K620/ K660	Yale KeyMark SFIC Complete / Housing Only	6 or 7	1-3/8"		No Collar		1-3/8"	1765.563							
K620/ K660	Yale KeyMark SFIC Complete / Housing Only	6 or 7	1-3/4"	Riveted	KP4	Riveted	1765.375					
A620/ K660	Best® Keyway SFIC Complete / Housing Only	6	1-1/4"	KC1	NA	KC1	NA	1-1/4"	KC1	1765.500					
A620/ K660	Best® Keyway SFIC Complete / Housing Only	6 or 7	1-3/8"				No Collar	1-3/8"		1765.563					
A620/ K660	Best® Keyway SFIC Complete / Housing Only	6 or 7	1-3/4"	Riveted	KP4	Riveted	1765.375					
2553	Schlage® "C" Keyway Fixed Core. Available 0-bitted or keyed random.	6	1-1/8"	2160	NA	2160	NA	1-1/8"	2160	1765.312					

Based on 1-3/4" door thickness. Collar length required must be specified for cylinders and/or housings ordered separately.

LFIC = Large Format Interchangeable Core

SFIC = Small Format Interchangeable Core

Cylinders



Cylinder Collars

If required, cylinder collar size must be specified.

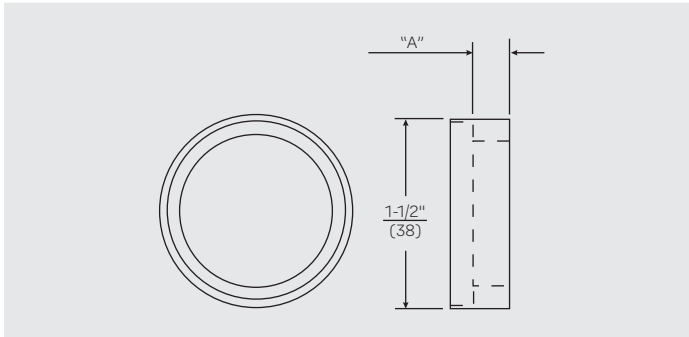

1765 Recessed Cylinder Collar

"A" Dimension: Thicknesses from 1/16" (2mm) to 1-15/32" (37mm) as required.

Material: Brass, Bronze

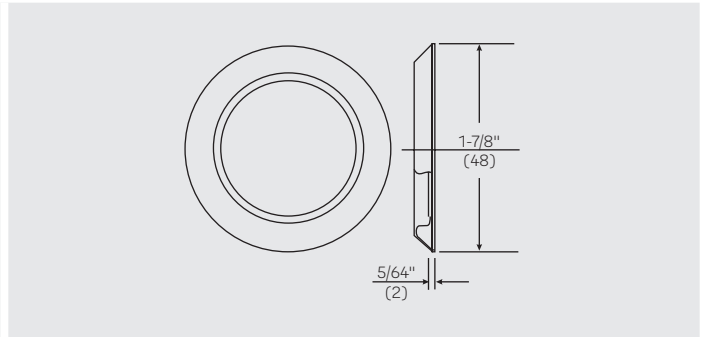

KP4 Flush Mount Cylinder Collar

Material: Brass, Bronze

Cams

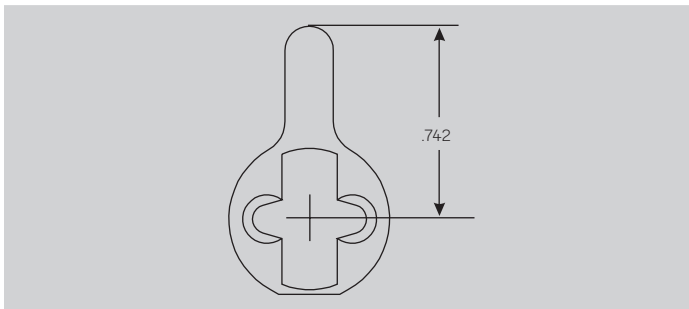

2160

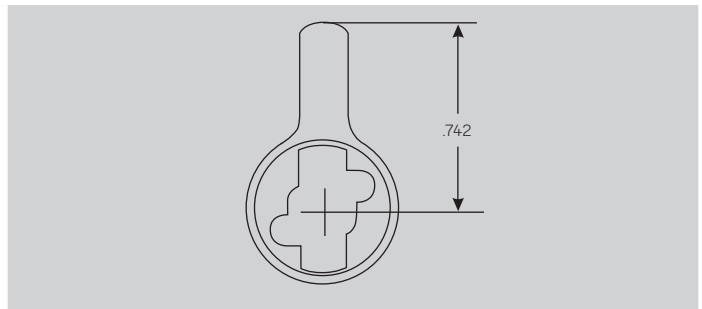

KC1

Strikes



Rim Devices

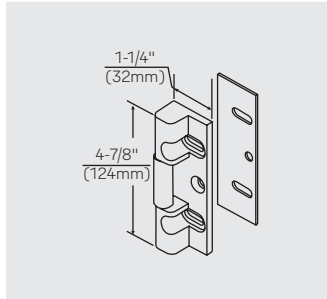

799
Standard strike for 1500(F) devices. Supplied with three shims, #12-24 machine screws, and #12 wood screws.

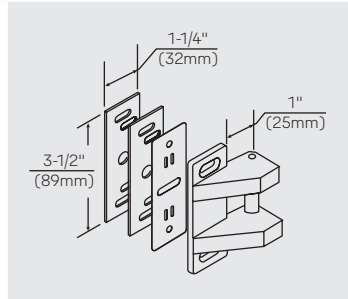

793
Optional strike for double door applications without a mullion. Supplied with #10-24 x 3/4" machine screws, two shims (each 1/16" thick), and one locking plate. Panic only.

Vertical Rod Devices - Top Strikes

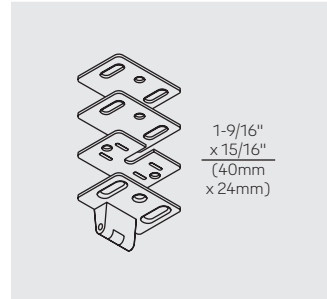

791
Standard top strike for 7110(F), 7120(F), 7210, 7220, 7210M(F), 7220M(F) series devices. Supplied with #10-24 x 3/4" machine screws, two shims (each 1/16" thick), and one locking plate.

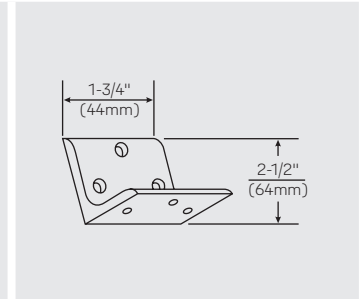

797
Optional bracket for mounting 791 top strike in flush transom opening. Supplied with 1/4-20 machine screws; SN-134 sex nuts, optional.

Vertical Rod Devices - Bottom Strikes

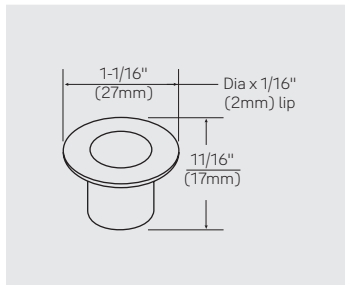

790
Standard bottom strike for 7110(F), 7120(F), 7160(F), 7170(F), 7210, 7220, 7210M(F), 7220M(F) series devices. Press in place.

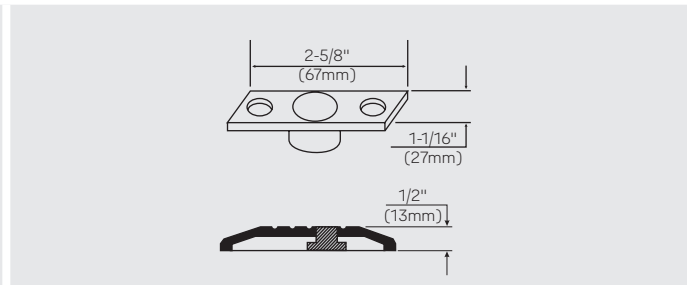

794
Optional bottom strike for fire openings using saddle thresholds or for flush floor mount. Must use for fire openings with 1/2" thresholds. Supplied with #10-24 x 1/2" machine screws and floor anchors.

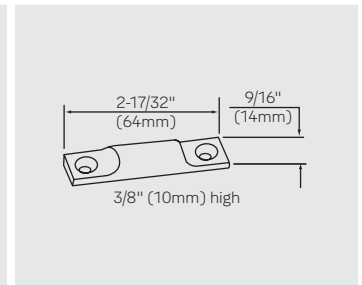

702
Optional bottom strike for bottom pullman latch option. Supplied with #8 x 8/32" combination screws.

Mortise Devices

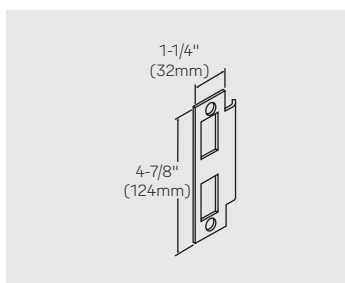

798
Standard curved lip ANSI strike used with 7130(F) devices. (1-1/4" lip)

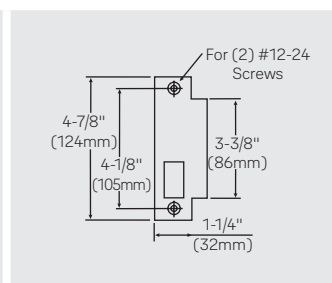

712
Optional flat lip ANSI strike used with 7130 devices for pairs of doors with astragals. (7/8" lip)

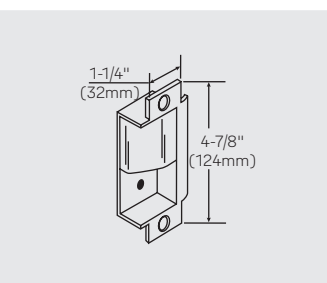

718
Optional open back strike. Permits opening of the inactive door for pairs of doors where approved by door manufacturer.

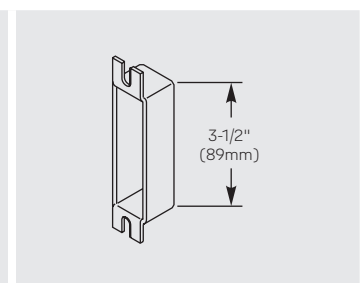

702
Optional strike box for ANSI strikes. 7/8" (22mm) deep.



Specialty Fasteners

SNB, 3/8" (10mm) diameter sex nuts for screws packed with exit devices. Supplied in exact number required on factory orders, or use packs as follows. Specify finish.

SN134 - Pack of (4) 1/4-20 sex nuts.

Torx® Security Screws - to deter tampering, supplied only with product order.

Bottom Pullman Latch

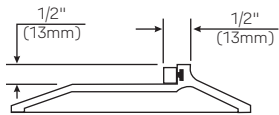
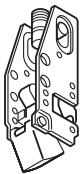

(P/No. 60-7010-0051-999), for use only with 1510 SVR devices in openings with pullman latch threshold as shown, threshold by others, or 702 floor strike.

To order with devices, specify "BPL."

Extension Rods

Model #	Length
7010-2	2" (51mm)
7010-6	6" (152mm)
7010-12	12" (305mm)
7010-24	24" (610mm)

Specify finish

Mullions

M200(F) Removable Mullion

M200(F) steel mullions are for use with 1500(F) series exit devices. Mullions may be field cut to fit opening. Red primer finish.

- M200 panic rated. Tubular steel, 2" x 3" (51mm x 76mm). Specify 7', 8', or 10'.
- M200F 3 hour fire rated. Tubular steel, 2" x 3" (51mm x 76mm). Specify 7' or 8'.

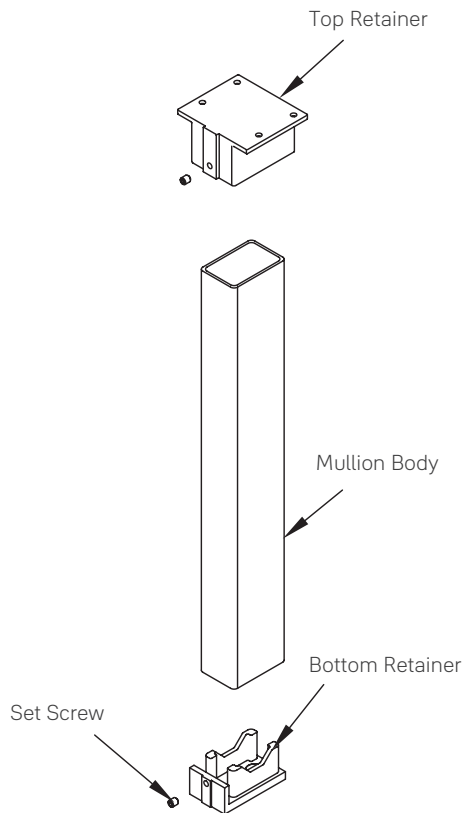

M200(F) Options

M203 Spacer Block Recommended for double rabbeted frames where the stop face width is less than the mounting hole spacing or for applications with 5-3/4" (146mm) or less door frames.

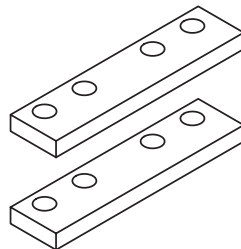

M204 Angle Bracket Recommended for any header configuration with less than 3" (76mm) of mounting surface.

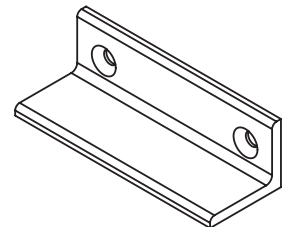

Mullions



KRM200(F) Keyed Removable Mullion (Krm)

Keyed removable mullions are for use with 1500(F) series exit devices. They are designed for simple removing when an unobstructed large opening is required and easy replacement and locking to maintain the integrity of the opening.

- KRM200 panic rated. Specify 7', 8', or 10'.
- KRM200F 1-1/2 hour fire rated. Specify 7' or 8'.

KRM Options

M203 Spacer Block

Recommended for double rabbeted frames where the stop face width is less than the mounting hole spacing or for applications with 5-3/4" (146mm) or less door frames.

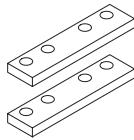

M204 Angle Bracket

Recommended for any header configuration with less than 3" (76mm) of mounting surface.

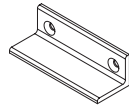

KRM Features

- Easy cylinder installation.
- Mullion automatically relocks when reinstalled without the use of the cylinder key.
- When ordering, add KR prefix to mullion, example: KRM200 and KRM200F.

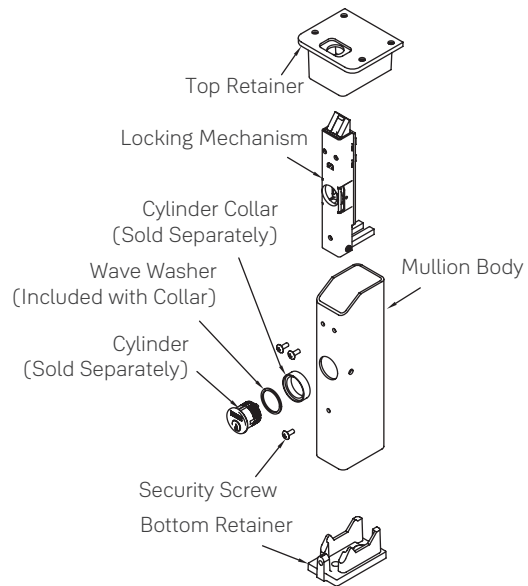

KRM Cylinders

As with any exit device trim, you must order a cylinder and collar if one is required. The Yale® keyed removable mullion accepts a mortise cylinder. Refer to page 19 for details.

Technical Specifications & Listings



ANSI/BHMA

Certified ANSI/BHMA A156.3, Grade 1.



Fire Listings

1500F series exit devices are UL-cUL Listed for use on fire doors having a rating up to and including 3-hours unless otherwise noted.

Note: Any retrofit or other field modification to a fire rated opening can potentially impact the fire rating of the opening, and Yale Locks & Hardware makes no representations or warranties concerning what such impact may be in any specific situation. When retrofitting any portion of an existing fire rated opening, or specifying and installing a new fire-rated opening, please consult with a code specialist or local code official (Authority Having Jurisdiction) to ensure compliance with all applicable codes and ratings.

ISO 9001

Designed and manufactured under a certified ISO 9001 quality system.

Warranty

The 1500 series exit devices carry a one-year warranty. Trims carry a five-year warranty.







Trusted every day

Phone

1-855-557-5078

Customer Service Email

customerservice.yale@assaabloy.com

Technical Product Support Email

techsupport.yale@assaabloy.com

Order Entry Email

orders.yaleus@assaabloy.com

Fax

1-800-338-0965

Website

www.yalecommercial.com

Contact Us

U.S.A.

Yale Locks & Hardware

Address: 225 Episcopal Road

Berlin, CT 06037-4004

Tel: 1-800-438-1951

Fax: 1-800-338-0965

us.yalehome.com

yalecommercial.com

Canada:

ASSA ABLOY Door Security Solutions Canada

Address: 160 Four Valley Drive

Vaughan, Ontario L4K 4T9

Tel: 1-800-461-3007

Fax: 1-800-461-8989

assaabloydss.ca

International:

ASSA ABLOY Americas International

Tel: 1-905-821-7775

Fax: 1-905-821-1429

assaabloyai.com

MicroShield®

ASSA ABLOY Group companies offer MicroShield®, an anti-microbial coating for door hardware. MicroShield uses proven silver ion-based technology from Agion®, a leading provider of antimicrobial solutions, to stem the spread of bacteria and other microbes.

MicroShield® is a registered trademark of ASSA ABLOY Access and Egress Hardware Group, Inc.



The Agion antimicrobial is not intended as a substitute for good hygiene. Coated products must still be cleaned to ensure the surfaces will be free of destructive microbes. ASSA ABLOY makes no representations or warranties, express or implied, as to the efficacy of the Agion antimicrobial. A copy of the Agion warranty is available upon request. Agion is a registered trademark of Agion Technologies, Inc., Wakefield, MA, USA.

THE YALE BRAND, with its unparalleled global reach and range of products, reassures more people in more countries than any other consumer locking solution.

THE ASSA ABLOY GROUP is the world's leading manufacturer and supplier of locking solutions, dedicated to satisfying end-user needs for security, safety and convenience.

Yale Commercial is a business associated with ASSA ABLOY Access and Egress Hardware Group, Inc., an ASSA ABLOY Group company. Copyright © 2006-2021, ASSA ABLOY Access and Egress Hardware Group, Inc. All rights reserved. Reproduction in whole or in part without the express written permission of ASSA ABLOY Access and Egress Hardware Group, Inc. is prohibited. Patent pending and/or patent www.assaabloydss.com/patents.



YDC200 Series

Economy Door Closer



Table of Contents



Contents

Features & Benefits.....	3
How to Order	4
Dimensions and Applications.....	5

YDC200 Economy Door Closer

Yale® YDC200 Series Economy Door Closer is a no-fuss, affordable option for aluminum storefront settings and other high volume applications. Certified to meet ANSI/ BHMA A156.4, Grade 1, YDC200 Series Door Closers provide a trusty and reliable solution to your commercial space, including retail, office buildings, and more.

Bringing you a dependable door closer at an attractive price point, Yale Works for YouSM.



Features & Benefits



Features

- Adjustable spring size 1-4 (YDC201) or fixed spring size 4 (YDC204)
- Tri-packed: regular, top jamb, or parallel mounting options
- Non-handed
- Cast aluminium body and threaded adjustable arm
- Rack & pinion design
- Independent latch, sweep, and backcheck intensity valves
- Available in two finishes
- 5 year limited warranty

Benefits

- **Ideal for a variety of facilities:** Well-suited to commercial, aluminum storefront, and hospitality applications
- **Ease of product selection:** Economical, affordable, no-fuss product offering
- **Great for retrofit applications:** 3/4" by 9-1/16" closer dimensions easily retrofit to a common footprint
- **Reliable:** UL/cUL listed and designed to meet ANSI/BHMA Grade 1 certification standards

How to Order



Please select model number and finish.

Model	Description	Finish
YDC201	Multi-sized Closer – Non-Hold Open	689 or 690
YDC204	Fixed Size 4 Closer – Non-Hold Open	

Notes:

- Door closer warranty becomes void if the closer is installed on the exterior side of a door in the exterior wall of a building.
- It is strongly recommended, and may be required on fire door assemblies, that doors having a door closer be hung on ball-bearing or anti-friction hinges or pivots. Consult local authority having jurisdiction.
- Failure to use fasteners supplied with closer may void factory warranty.
- Fasteners for fire/smoke door assemblies must conform to NFPA 80. In some applications additional fasteners may be mandated by NFPA 80 that are not shipped with standard Yale® product, such as sleeve-nuts/sex-nuts or thru bolts and grommet nuts.
- Information provided is based on 1-3/4" (44mm) x 7' (2.13m) standard weight doors swinging to 110°. Other conditions (such as door height or weight; or wind/draft conditions) may require adjustment of spring setting, selection of a larger size closer or different closer.

Finishes

ANSI/BHMA Code Finish Description	
689 Aluminum Painted	690 Dark Bronze Painted
	

Parts List

Description	Part Number*
Sleeve Nuts (1-3/4" door only)	SN-134
Cover (order by part number)	YDC200COV

*Specify finish when ordering.



Optional cover
(YDC200COV)



Dimensions and Applications

Dimensions

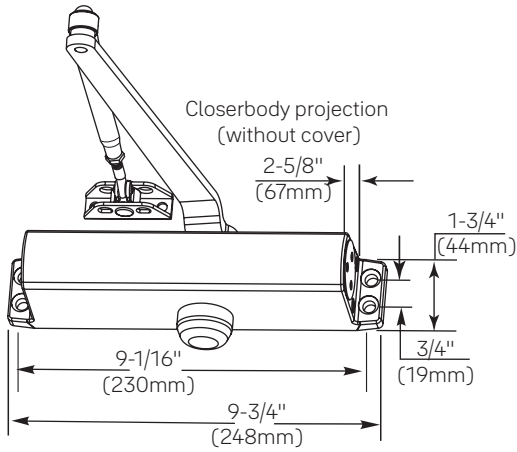

Door Closing Latching Cycle

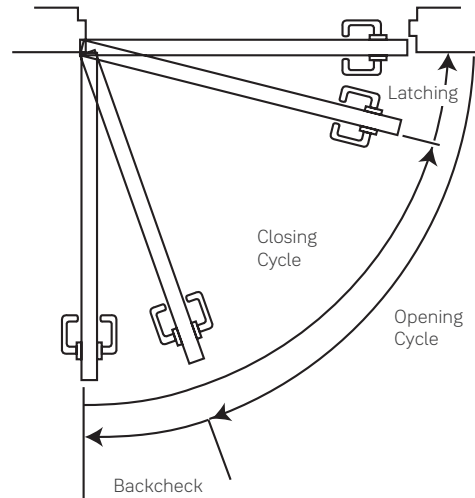

Applications



Regular Arm



Top Jamb



Parallel Arm

Consult factory if door weight exceeds 150 lbs.







Trusted every day

Customer Service Phone:

1-800-438-1951

Customer Service Fax:

1-800-338-0965

24/7 Support Phone:

1-855-213-5841

24/7 Support Email:

Support@YaleLock.com

Website:

yalecommercial.com

Email for orders:

orders.yaleus@assaabloy.com

Contact Us

U.S.A.

Yale Locks & Hardware

Address: 225 Episcopal Road

Berlin, CT 06037-4004

Tel: 1-800-438-1951

Fax: 1-800-338-0965

yalelocks.com

Canada:

ASSA ABLOY Door Security Solutions Canada

Address: 160 Four Valley Drive

Vaughan, Ontario L4K 4T9

Tel: 1-800-461-3007

Fax: 1-800-461-8989

assaabloydss.ca

International:

ASSA ABLOY Americas International

Tel: 1-905-821-7775

Fax: 1-905-821-1429

assaabloyai.com

THE YALE BRAND, with its unparalleled global reach and range of products, reassures more people in more countries than any other consumer locking solution.

THE ASSA ABLOY GROUP is the world's leading manufacturer and supplier of locking solutions, dedicated to satisfying end-user needs for security, safety and convenience.

Yale Commercial is a business associated with ASSA ABLOY Access and Egress Hardware Group, Inc., an ASSA ABLOY Group company. Copyright © 2017-2020, ASSA ABLOY Access and Egress Hardware Group, Inc. All rights reserved. Reproduction in whole or in part without the express written permission of ASSA ABLOY Access and Egress Hardware Group, Inc. is prohibited. Patent pending and/or patent www.assaabloydss.com/patents.



5800 Series

Cast Iron Door Closers



An ASSA ABLOY Group brand

ASSA ABLOY



Introduction

CONTENTS

Introduction	2
Features & Benefits	3
Finishes	4
How to Order	5
Functions & Arm Options	5
Arm Option.....	6
Model/Part Numbers	7
Accessories	8

5800 SERIES CAST IRON DOOR CLOSERS

With its modern design and adjustable operation, Yale 5800 Series Cast Iron Door Closers provide an attractive solution for retail, office, government and other commercial facilities. Heavy-duty and hold open arms, along with adjustable spring size, backcheck, closing and latch speed, provide a flexible and economical closer that you can trust for dependable service. The 5800 Series is certified to ANSI/BHMA Grade 1 requirements for long life and reliability, and offers a 10 year warranty. With a full feature set and stylish design, Yale Works for YouSM.







Features & Benefits



FEATURES

- ANSI/BHMA A156.4 Grade 1 certified
- Adjustable spring sizes 1 - 6
- Cast iron closer body
- Standard and heavy-duty arms available as hold open or non-hold open
- Adjustments for backcheck, closing and latch speed
- Tri-packed for parallel, regular or top jamb installation
- Sleeve nuts and bolts provided with each closer
- Retrofit for LCN 4040XP
- Non-handed
- Plastic cover
- 10 year warranty

COMPLIANCE STANDARDS

- Certified for ANSI/BHMA A156.4 Grade 1 
- 90 minute positive pressure fire rating per UL10c and CAN / ULC S104 
- Meets requirements for Americans with Disabilities Act (ADA) and ANSI/BHMA A117.1 

BENEFITS

- **Reliable:** Adjustable spring power, latch and closing speeds ensure positive latching
- **Flexible:** Choice of standard or heavy-duty arms and adjustable spring power meets needs of any application
- **Hassle-Free Retrofits:** Easily replaces competitive closers
- **Strong and Durable:** ANSI/BHMA Grade 1 certified for long life

CAUTION: Door Closers for Low Opening Force Applications:

Door closers installed in openings required to meet the requirements of the Americans With Disabilities Act or ANSI/BHMA Standard A117.1, when adjusted to meet those requirements, may not provide adequate closing power to dependably close and latch the door based on opening or site conditions.



Finishes

ANSI/BHMA Code Finish Description		
689 Aluminim Painted	690 Dark Bronze Painted	BSP Black Suede Powder Coat
		



How To Order

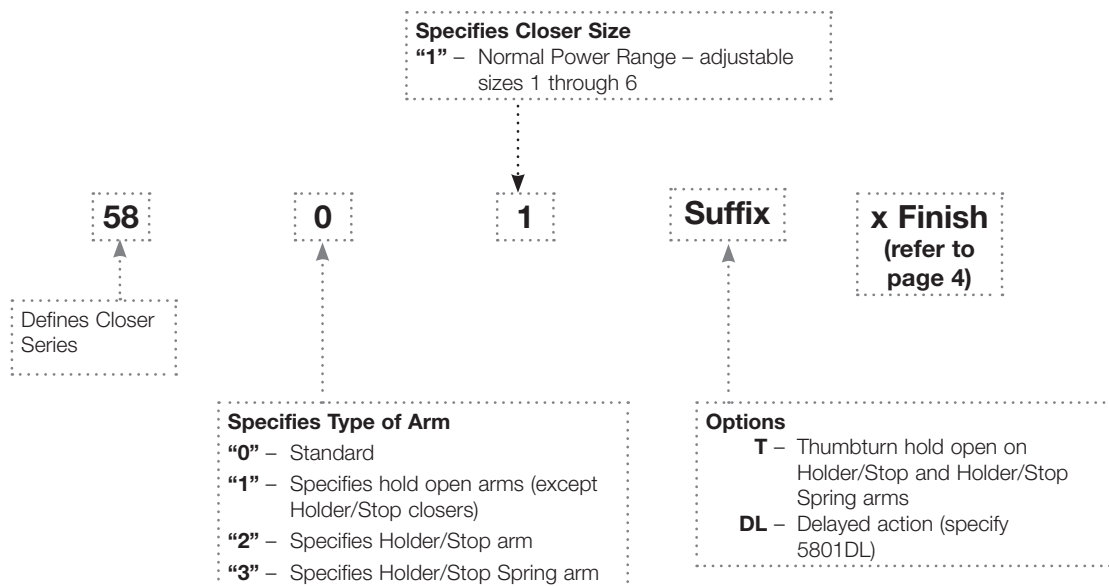

FUNCTIONS

- Backcheck
- Closing speed
- Latching speed
- Delayed action; specify 5801DL

ARMS

Non-Hold Open

Self-closes door every time door is opened. Auxiliary stop (by others) required except when using the Holder/Stop arm.

Hold Open

Achieved by means of friction or ball and detent/roller. Friction hold open has a range of 90° to 180° using template location and mechanical adjustment. Ball and detent or roller hold open is effective in a range of 85° to 110°.

Hold open arm door closers are not permitted to be used on fire door assemblies.

Notes:

- For heavy-duty parallel rigid arm applications, specify 5821 or 5821T, stop is removable.
- Door closer warranty becomes void if the closer is installed on the exterior side of a door in the exterior wall of a building.
- It is strongly recommended, and may be required on fire door assemblies, that doors having a door closer be hung on ball-bearing or anti-friction hinges or pivots. Consult local authority having jurisdiction.
- Failure to use fasteners supplied with closer may void factory warranty.
- Fasteners for fire/smoke door assemblies must conform to NFPA 80. In some applications additional fasteners may be mandated by NFPA 80 that are not shipped with standard Yale product, such as sleeve-nuts/sex-nuts or thru bolts and grommet nuts.
- Information provided is based on 1-3/4" (44mm) x 7' (2.13m) standard weight doors swinging to 110°. Other conditions (such as door height or weight; or wind/draft conditions) may require adjustment of spring setting, selection of a larger size closer or different closer.

DOOR CLOSING LATCHING CYCLE

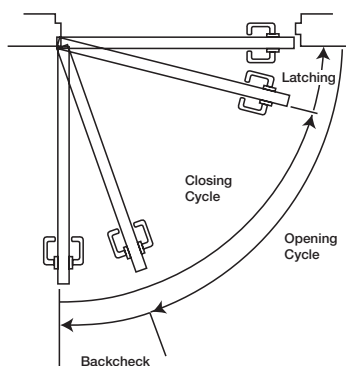



Arm Options

Regular Arm

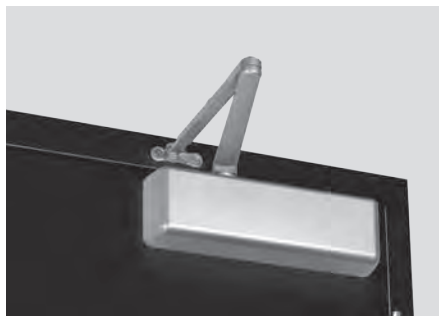

Non-hold open arm shown, hold open application available.

- Pull side application, double lever arm
- Sufficient frame, door and/or ceiling clearance must be considered
- Due to arm projection, application may present an aesthetics issue or be prone to vandalism

Top Jamb



Non-hold open arm shown, hold open application available.

- Push side application
- Sufficient frame face and/or ceiling clearance must be considered
- 2-1/4" (57mm) top rail on door is required
- Best door control for doors in exterior walls that swing out of building
- Consideration must be given to depth of reveal

Parallel Arm

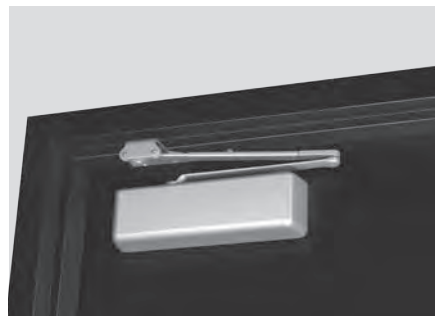

Non-hold open arm shown, hold open application available.

- Push side application
- In the closed position, there is little or no hardware projection beyond the frame face
- Due to arm geometry, approximately 25% less power-efficient than regular arm application
- Closer and arm mounted below the frame stop

HOLDER/STOP ARM



5821T (hold open) shown

- Holder/Stop arms incorporate a stop at the arm's soffit plate to dead stop the door at a predetermined degree of door swing between 85° and 110°, in 5° increments
- Prior to dead stop, backcheck slows the door speed to reduce the stop action

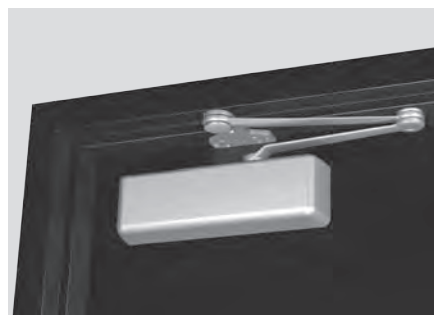

5821 (non-hold open, without stop) shown

- Holder/Stop arm is intended for use where an auxiliary door stop cannot be used and low to moderate abuse is anticipated
- Stop is removable to allow for additional applications where auxiliary door stops are installed

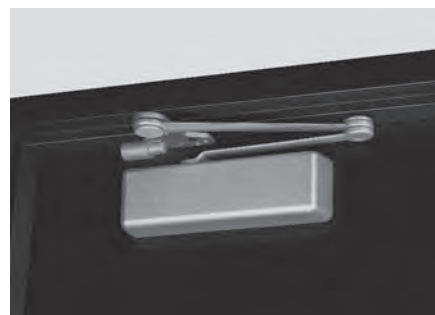

5831 (non-hold open, with spring) shown

- Holder/Stop Spring arms incorporate a buffer spring that provides greater protection at the end of the door opening cycle
- Spring is removable

Consult factory if door weight exceeds 250 lbs.



Model/Part Numbers

Model Number	Description
5801	Non-Hold Open Tri-Packed
5801DL	Non-Hold Open Tri-Packed, Delayed Action
5811	Hold Open Tri-Packed
5821	Heavy-Duty Non-Hold Open Parallel Arm with Removable Stop
5821T	Heavy-Duty Hold Open Parallel Arm with Thumbturn and Removable Stop
5831	Heavy-Duty Non-Hold Open Parallel Arm with Spring and Removable Stop
5831T	Heavy-Duty Hold Open Parallel Arm with Thumbturn, Spring and Removable Stop

Note: for heavy-duty parallel rigid arm applications, specify 5821 or 5821T, stop is removable.

See page 5 for more how to order info.



Miscellaneous Parts*	
Part Number	Description
5800COV	Full Plastic Cover
5800SP	Screw Pack
2730Kit	Door Saver Spring Stop

*Specify finish when ordering.

Cover Dimensions		
Width	Length	Projection
3-1/2" (89mm)	12-1/4" (311mm)	2-1/4" (57mm)

Optional Fasteners	
Part Number	Description
SN-134	Sleeve Nuts
TBGN134-47	Through-Bolts & Grommet Nuts

Note: Sleeve nuts furnished standard with all models.



2730Kit



Accessories

CLOSER MOUNTING PLATES

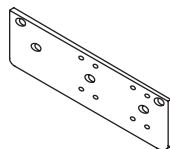

5800RDP Narrow Frame Drop Plate (regular arm):

Required for hinge side mount where top rail is less than 3-3/4" (95mm). Plate requires 2" (51mm) minimum top rail.

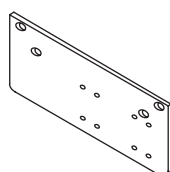

5800PDP Narrow Top Rail Drop Plate (parallel arm):

Required for parallel arm mounting where top rail is less than 5-1/2" (140mm), measured from the stop. Plate requires 2" (51mm) minimum top rail.

Note: All measurements are Inches/mm.



Notes



Notes



Notes

Contact Us

The world's favorite lock



U.S.A.

Yale Locks & Hardware

Address: 225 Episcopal Road
Berlin, CT 06037-4004
Tel: 1-800-438-1951
Fax: 1-800-338-0965
yalelocks.com

Canada:

ASSA ABLOY Door Security Solutions Canada

Address: 160 Four Valley Drive
Vaughan, Ontario L4K 4T9
Tel: 1-800-461-3007
Fax: 1-800-461-8989
assaabloydss.ca

International:

ASSA ABLOY Americas International

Tel: 1-905-821-7775
Fax: 1-905-821-1429
assaabloyai.com

Yale Commercial is a business associated with ASSA ABLOY Access and Egress Hardware Group, Inc., an ASSA ABLOY Group company. Copyright © 2012-2020, ASSA ABLOY Access and Egress Hardware Group, Inc. All rights reserved. Reproduction in whole or in part without the express written permission of ASSA ABLOY Access and Egress Hardware Group, Inc. is prohibited. Patent pending and or patent www.assaabloydss.com/patents.

YALE, with its unique global reach and range of products, is the world's favorite lock.

ASSA ABLOY is the global leader in door opening solutions, dedicated to satisfying end-user needs for security, safety and convenience.

42835-6/20



4400 Series Institutional Door Closer



The Engineer's Choice



Contents

Overview	3
Fasteners and Features.....	4
Optional Features.....	5-6
Finishes.....	7
How To Order.....	8-9
Applications	10-14
Technical Details	15-25
Accessories	16-34
Parts List	35-47
Suggested Specifications.....	48

Yale's 4400 Series Institutional Door Closers offer customers the ideal combination of superior performance, quality and strength. With upgraded pinion and piston materials, improved valve design, and staked valves, the closers are the most efficient, dependable closers in the industry. The size 1-6 spring also simplifies the process of specifying and ordering product.

This U.L. listed, ANSI/BHMA Grade 1 certified closer has a proven history. It is an ideal choice for interior or exterior doors in facilities that demand reliability such as schools, office buildings, hospitals, department stores and airports. Yale Works for YouSM.

Overview



Cutaway View

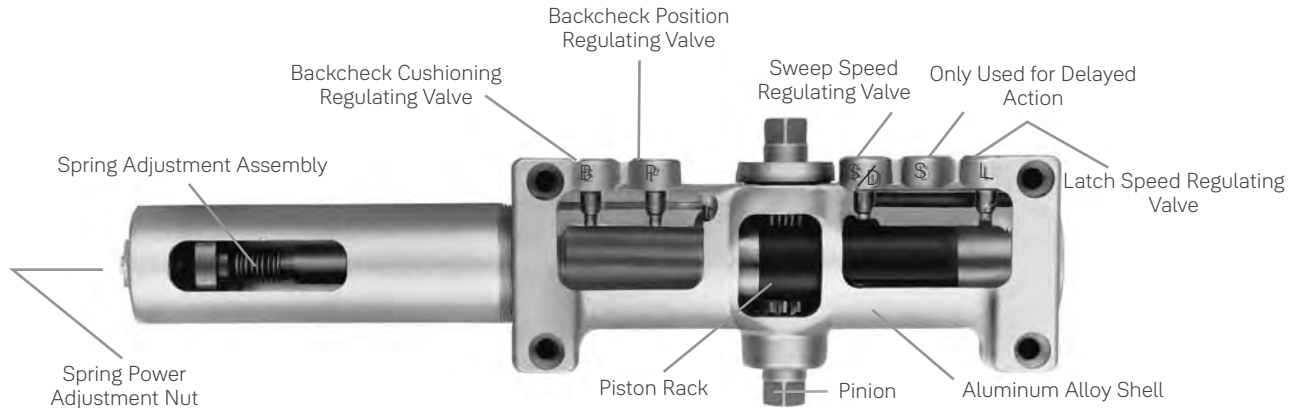

Compliance Standards

- ANSI/BHMA A156.4, Grade 1 certified
- UL / cUL listed for use on fire rated doors
- UL10C listed for positive pressure fire test
- 4400 door closers are designed to comply with requirements for the Americans with Disabilities Act (ADA) and ANSI standard A117.1
- Manufactured in an ISO 9001, ISO 14001 facility



An Environmental Product Declaration (EPD) documents the cradle-to-grave life cycle of a product and how it affects the environment. An important aspect of EPD® is to provide the basis of a fair comparison of products and services by its environmental performance. EPDs can reflect the continuous environmental improvement of products and services over time and are able to communicate and add up relevant environmental information along a product's supply chain.

CAUTION: Door Closers for Low Opening Force Applications:

Door closers installed in openings required to meet the requirements of the Americans With Disabilities Act or ANSI/BHMA Standard A117.1, when adjusted to meet those requirements, may not provide adequate closing power to dependably close and latch the door based on opening or site conditions.

Features

- Exceeds 25 million cycles
- Cast aluminum body
- Adjustable spring sizes 1 through 6 (ADA Compliant)
- Tri-packed (regular arm, top jamb, and parallel arm mounting)
- Rack and pinion design
- Staked valves
- Separate and independent, latch, sweep and backcheck intensity valves
- Non-handed
- 1-1/2" (38mm) diameter piston
- 5/8" (16mm) diameter pinion journals
- 2-1/8" (54mm) projection (standard covers)
- All standard arm applications allow doors to swing 180°, conditions permitting
- 30-year limited warranty
- Self-drilling screws
- Molded plastic cover
- Backcheck positioning valve
- Full-size template

Optional Features

- Corrosion-resistant model (Non-Hold Open only) (4400S only)
- Metal cover
- Enhanced backcheck (specify EBC suffix)
- Delayed action with pressure relief valve
- Heavy-duty arms: Regular Rigid, Parallel Rigid, Holder/Stop, Holder/Stop Spring, UNI Stop™
- Slide Tracks: push or pull side mounting
- Lead-lined metal cover (specify MLL suffix)

Fasteners and Features



Fasteners

Type	Description	Arm								
		RA	PA	TJ	Low Profile	PR	Holder/Stop, Holder/Stop Spring	UNI	UNI-J	Slide Track
DOOR										
SDST	Self Drilling Self Tapping	S	S	S	S	S	S	S	0	0
MS	Machine Screw	S	S	S	S	S	S	S	S	S
SN	Sleeve Nut	0	0	0	0	S	S	S	S	S
TBGN	Thru Bolts & Grommet Nuts	0	0	0	0	0	0	0	0	0
SMS	Sheet Metal Screws	0	0	0	0	0	0	0	0	0
TORX	TORX Drive Security Screw	0	0	0	0	0	0	0	0	0
FRAME										
SDST	Self Drilling Self Tapping	S	S	S	S	S	S	S	S	S
MS	Machine Screw	S	S	S	S	S	S	S	S	S
SMS	Sheet Metal Screws	0	0	0	0	0	0	0	0	0
TORX	TORX Drive Security Screw	0	0	0	0	0	0	0	0	0

S = standard; 0 = optional

SN are for use on unreinforced hollow metal doors or to prevent any hollow metal door from collapse/dimpling. They can also be used for thru bolting on wood doors. SN are supplied for 1-3/4" (44mm) thick doors unless specified for 2-1/4" (57mm) thick doors.

TBGN are an alternative to SN for wood doors. TBGN are supplied standard for 1-3/4" (44mm) thick doors. They can be specified for 1-3/8" (35mm) thick doors.

SMS - when specified, closer will be packed with sheet metal screws for the door **AND** sheet metal screws plus machine screws for the frame.

TORX are only available with machine screw threads. Sheet metal screw threads are not available.

Features

Aluminum Alloy Housing

Closer bodies are constructed of a special aluminum alloy, carefully selected to accommodate interactive steel components and operating conditions.

Rack & Pinion Operation

Provides a smooth constant control of the door through its full opening and closing cycle. 180° door swing can be achieved when door, frame, hardware and arm function do not interfere.

Non-handed

With few exceptions all 4400 series door closers are non-handed and can be installed on either right or left-hand swing doors. Pinion shaft extends vertically through the closer body in both directions. Some options, as noted on page 5, will require that the hand of the closer be specified.

Sweep Speed Control Valve

Allows adjustment of door speed from the door's full open position down to approximately 10° from the closed position.

Latch Speed Control Valve

Allows adjustment of door speed from approximately 10° down to the door's fully closed position.

Closer Fluid

All door closers are supplied with a temperature stable, multi-viscosity fluid. This fluid will permit the door closer to perform within a wide temperature range: from very high to as low as -40°F.

Tri-Packed

4400 series come with screws, brackets and soffit plates to allow for regular, top jamb, and parallel arm installations.

Adjustable Backcheck Cushion Valve

Provides control of the door in the opening cycle, beginning at approximately 75° of door opening. It slows/cushions the door opening when the door is forcibly opened beyond its pre-adjusted limits.

Adjustable Backcheck Position Valve

Allows the door opening position, where backcheck cushioning begins to be adjusted to a greater door angle up to a maximum of 20° farther (approximately 95°).

Standard Molded Covers

Molded of high-impact U.L. listed material. This cover is non-handed for all applications. See page 5 for optional metal cover.

Warranty

Limited 30-year warranty for defects and life of the building on the aluminum housing.

Optional Features



Door Closer Power Options

Series 4400 Multi-Sized Door Closer

Adjustable through the power range of sizes 1 through 6; as outlined in ANSI/BHMA standard A156.4.

The series 4400 also conforms to the minimum opening force requirements for The American with Disabilities Act (ADA) and ANSI/BHMA standard A117.1 for interior doors.

Optional Covers



Optional Metal Cover

This steel cover is non-handed for regular and parallel arm applications, but is handed for top jamb applications. Cover is available in sprayed or plated finishes.

Optional ABS Cover

Contact factory for details.

Optional Features

Corrosion-Resistant Door Closer

The series 4400S door closers with molded plastic cover are available for use where brass conditions exist. This series is provided with brass adjustment valves adjustment valves, a 440 grade stainless steel pinion shaft, an all-aluminum body and bronze closer arm bushing; all other components and fasteners are of 302/303 grade stainless steel. Fasteners are 8-18 stainless steel. This product is available for standard regular arm, top jamb and parallel arm, non-hold open applications only.

Optional Features



Delayed Action

Adjustable Delayed Action Closing

An optional hydraulic feature that adds a third speed range to the closing cycle. This feature becomes effective when the door is opened and released at any point beyond 70°. The amount of time delay depends upon the combination of the angle of door release and valve adjustment. The valve can be adjusted with a 1/8" (3mm) hex key from no delay time up to maximum delay times of:

Door Opened and Released at	Approximate Time of Delay Cycle
180°	4-5 minutes
120°	2-3 minutes
90°	25-30 seconds

Pressure Relief Safety Valve

The delayed action hydraulic system contains a pressure relief valve. Any time the door is forced toward the closed direction while it is in the closing cycle, the valve will open and permit the door to close. This prevents damage to door, frame and closer.

Suggested Applications

Delayed Action closing allows slow-moving traffic to clear the opening before the door closer's normal closing cycle begins. This feature can be helpful in health care facilities such as hospitals and nursing homes. It provides sufficient time for persons on crutches or in wheelchairs to pass through a door without concern of it closing. At the same time, it can accommodate the facility's staff with movement of food service carts, beds, and other wheeled traffic.

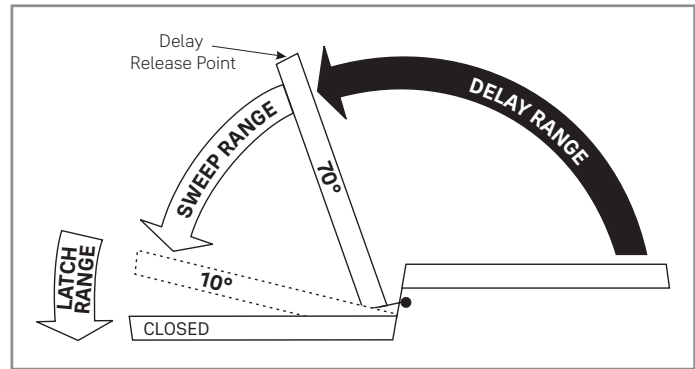

Use of delayed action closers on many doors throughout industrial and commercial buildings can also assist the flow of traffic. Locations where additional time to clear the opening is advantageous are doors between office and factory/warehouse facilities, doors to workshops or laboratories, to kitchen and food processing areas, etc.

Enhanced Backcheck

This feature provides adjustable backcheck intensity beginning at approximately 15° of the door opening cycle. It is intended for use in situations where the standard backcheck beginning at approximately 75° of door opening allows too much unrestricted door travel to obtain control of the door without the fear of peripheral damage to the door closer, door, frame, hinges or pivots; or adjacent walls or structures. This feature is most frequently used in schools and detention facilities. Specify suffix EBC.

Arms

Non-Hold Open

Self-closes door every time door is opened. Auxiliary stop (by others) required except when using the Holder/Stop, Holder/Stop Spring or UNI Stop™ arms.

Hold Open

Achieved by means of friction or ball and detent/roller. Friction hold open has a range of 90° to 180° using template location and mechanical adjustment.

Ball and detent or roller hold open is effective in a range of 85° to 110°.

Hold open arm door closers are not permitted to be used on fire door assemblies.

Door Opening Degrees

Arm Function	Regular Arm, Top Jamb, Parallel Arm	Parallel Rigid Arm	Holder/Stop Parallel Arm	Holder/Stop Spring Parallel Arm	UNI Stop Parallel Arm	UNI Stop Top Jamb	Low Profile	Slide Track
Non-Hold Open	✓	✓	85° to 110°	85° to 110°	85° to 110°	85° to 110°	✓	85° to 110°/180°
Hold Open	90° to 180°	85° to 180°	85° to 110°	85° to 110°	85° to 110°	85° to 110°	N/A	85° to 110°

✓=180° trim and template permitting

Finishes



Product will be painted with a combination of waterborne acrylic and polyester powder coat. Closers will withstand 100 hours of salt spray. (The ANSI requirement is 25 hours.)

ANSI/BHMA Code Finish Description			
600* Primed for Painting	605 Bright Brass, Clear Coated	606 Satin Brass, Clear Coated	611 Bright Bronze, Clear Coated
			
612 Satin Bronze, Clear Coated	613E Dark Oxidized Satin Bronze - equivalent	625 Bright Chrome Plated	626 Satin Chrome Plated
			
689 Aluminum Painted	690 Dark Bronze Painted	691 Light Bronze Painted	693 Black Painted
			
694 Medium Bronze Painted	696 Satin Brass Painted	BSP Black Suede Powder Coat	WSP White Suede Powder Coat
			

*600 is a special rust-inhibiting prime coat. Closers can be ordered prime coat only (specify closer x 600). An additional charge applies if finish coat is required over prime coat (ex: 4400 x 600 x 689).

Plated Finishes	Specify Designation (ANSI/BHMA)	Metal Covers Only
Bright Brass	605	Yes
Satin Brass	606	Yes
Bright Bronze	611	Yes
Satin Bronze	612	Yes
Bright Chrome	625	Yes
Satin Chrome	626	Yes

When a plated finish is ordered, arm and cover will be plated unless "cover only" is specified.

How To Order 4400 Series

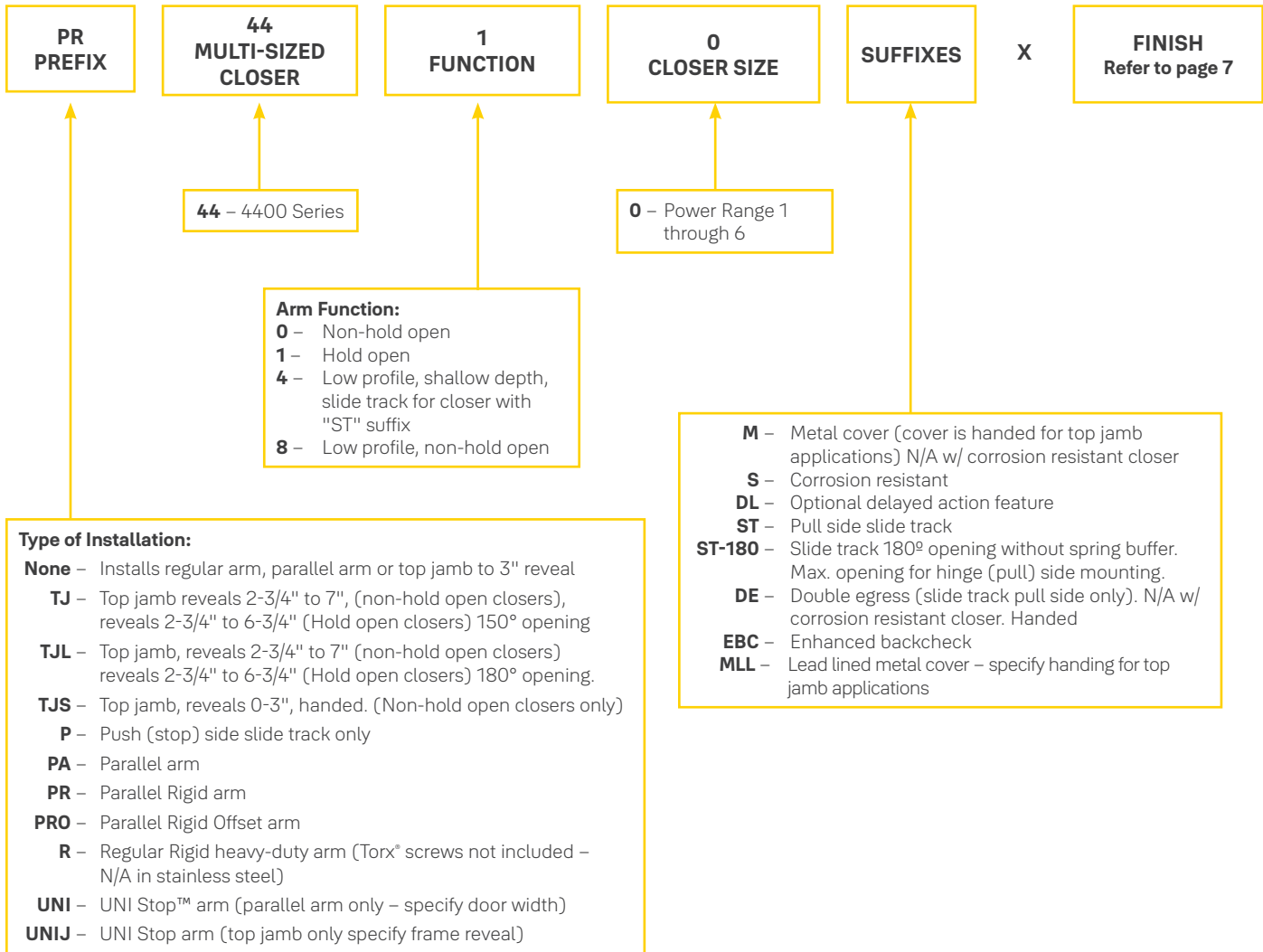

Notes:

- Door closer warranty becomes void if the closer is installed on the exterior side of a door in the exterior wall of a building.
- It is strongly recommended, and may be required on fire door assemblies, that doors having a door closer be hung on ball-bearing or anti-friction hinges or pivots. Consult local authority having jurisdiction.
- Failure to use fasteners supplied with closer may void factory warranty.
- Fasteners for fire/smoke door assemblies must conform to NFPA 80. In some applications additional fasteners may be mandated by NFPA 80 that are not shipped with standard product, such as sleeve-nuts/sex-nuts or thru bolts and grommet nuts.
- Information provided is based on 1-3/4" (44mm) x 7' (2.13m) standard weight doors swinging to 110°. Other conditions (such as door height or weight; or wind/draft conditions) may require adjustment of spring setting, selection of a larger size closer or different closer.

How To Order Holder/Stop & Holder Stop Spring Assemblies

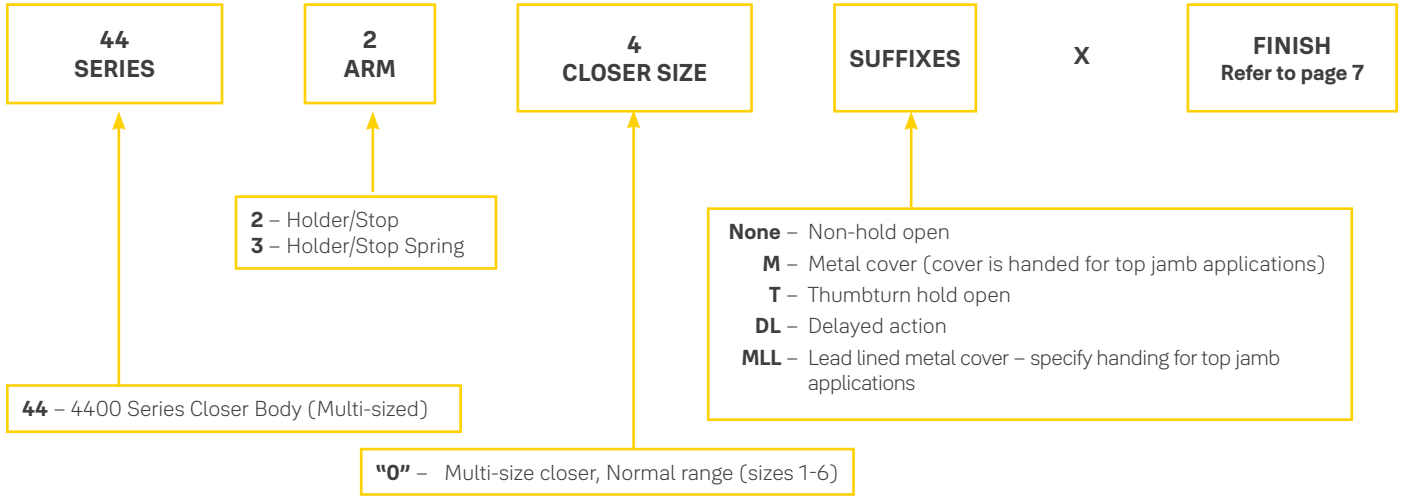

Notes:

- Door closer warranty becomes void if the closer is installed on the exterior side of a door in the exterior wall of a building.
- It is strongly recommended, and may be required on fire door assemblies, that doors having a door closer be hung on ball-bearing or anti-friction hinges or pivots. Consult local authority having jurisdiction.
- Failure to use fasteners supplied with closer may void factory warranty.
- Fasteners for fire/smoke door assemblies must conform to NFPA 80. In some applications additional fasteners may be mandated by NFPA 80 that are not shipped with standard product, such as sleeve-nuts/sex-nuts or thru bolts and grommet nuts.
- Information provided is based on 1-3/4" (44mm) x 7' (2.13m) standard weight doors swinging to 110°. Other conditions (such as door height or weight; or wind/draft conditions) may require adjustment of spring setting, selection of a larger size closer or different closer.



Non-hold open arm shown

Regular Arm

This is the only pull-side application where a double lever arm is used. It is the most power-efficient application for a door closer. Sufficient frame, door and/or ceiling clearance must be considered.

Since the arm assembly projects directly out from the frame, this application may present an aesthetics issue or be prone to vandalism.



Non-hold open arm shown

Parallel Arm

This application provides the most appealing design appearance for a surface-mounted door closer having a double lever arm. This also makes it beneficial in vandalism-prone areas. It is on the push side of the door and the arm assembly extends almost parallel to the door. In the closed position, there is very little or no hardware projecting beyond the frame face in most situations.

Due to the geometry of the arm it is approximately 25% less power efficient than a regular arm application.

The entire closer and arm assembly are mounted below the frame stop, requiring a top rail clearance on the door of between 6-5/8" (168mm), when using a low profile arm, to 7-1/4" (184mm), when using the hold open arm.



Non-hold open arm shown

Top Jamb

For efficiency reasons this application provides the best alternative to the regular arm application. There must be sufficient frame face and/or ceiling clearance for this application. It requires a top rail on the door of just 2-1/8" (54mm). This application provides the best door control for doors in exterior walls that swing out of a building.

The entire door closer and arm assembly project from the frame, similar to the regular arm application, where the matters of appearance and malicious abuse can be of concern. Consideration must be given to depth of reveal.



Parallel Rigid Arm

An enhanced variation of the standard parallel arm assembly that is intended for use in heavy traffic areas where auxiliary door stops are installed. Hold open available – specify hand when ordering.



Parallel Rigid Offset Arm

This heavy-duty parallel rigid arm provides additional vertical clearance. It is well suited for applications where weather-stripping or other hardware prevents the use of the standard Parallel Rigid (PR) soffit plate. The non-hold open and hold arms allow 1-1/4" clearance. When used in conjunction with a #6891 spacer block, the PRO arm provides 1-7/8" clearance to accommodate the use of a surface overhead stop/holder.



Holder/Stop Arm

Similar to the Parallel Rigid arm, this arm incorporates a stop at the arm's soffit plate to dead stop the door at a predetermined degree of door swing between 85° and 110°, in 5° increments. Prior to dead stop the door closer's backcheck feature slows the door speed to reduce the impact of the stop action.

The Holder/Stop Arm is intended for use where an auxiliary door stop cannot be utilized and no more than moderate abuse is anticipated. Where more extreme conditions are expected, use of a UNI Stop™ arm is recommended.

Thumbturn hold open available. (Hold open strength is adjustable.)

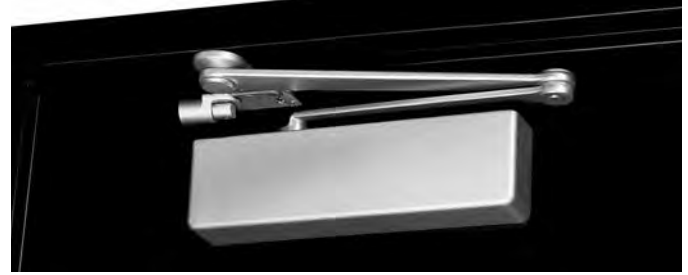

Holder/Stop Spring Arm

This heavy-duty stop arm includes all of the features of the Holder/Stop arm, plus an additional steel buffer spring that provides greater protection at the end of the door opening cycle. For extreme conditions, use of a UNI Stop™ is recommended. Available with or without hold open.



Regular Rigid Heavy-Duty Arm

This double lever arm features a non-adjustable secondary arm. Orbitally riveted joints prevent tampering or disassembly. Prefix "R" to model number. Available non-hold open only.

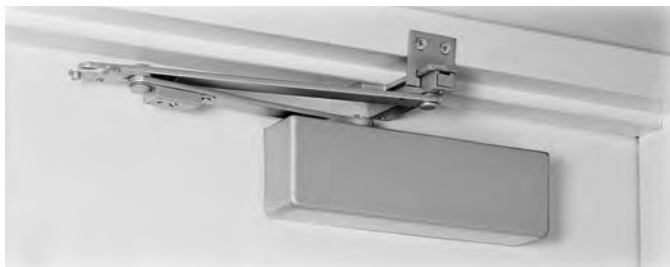

Parallel arm



Top jamb

UNI Stop™ Arm

Can be used for either parallel arm or top jamb applications. UNI Stop arms combine the features of a double lever arm overhead door stop/holder with the backcheck feature of the door closer to reduce door stopping shock loads to a minimum. The UNI Stop uses a compression spring buffer at the soffit plate/arm shoe that will absorb 30 lbf. of force, 5° prior to the door's dead stop. Coupled with the door closer's backcheck feature, this arm provides the most controlled stop available with a surface door closer.

Only available in painted finishes.

For parallel arm applications there are three different length arm assemblies. Each length is designed for a specific range of door widths to provide precise door control. This further lessens the dead stop impact on the door's hinges/pivots.



Corner Bracket

This application can be used where top jamb and parallel arm application will not accommodate the door and frame conditions. Requires minimal top rail on the door; however, vertical clearance to the floor within the door opening should be checked to ensure code compliance.

The close proximity, for this application, of the door closer to the door's pivot point reduces the door closer's power efficiency by approximately 25% when compared to a regular arm. The projection of the arm from the door face might pose questions regarding design parameters.



Pull Side



Low Profile Pull Side



Push Side



Low Profile Push Side

Slide Track

Whether pull or push side mounted, this provides the designer with the smoothest lines available in a surface mounted door closer. The single lever arm allows components to be located in a stack configuration to minimize projection and eliminate obtrusive arm angles.

The arm geometry reduces door closer power efficiency by approximately 25% from that of a regular arm.



Regular arm

4480



Parallel arm

PA4480

Low Profile Arm

Supplied with 2400/4480 series door closers for non-hold open installations only. These arms have a reduced height elbow joint and a straight main arm. This enables the door closer to be installed in less vertical space:

Regular Arm Allows closer to be installed where there is as little as 1" (25mm) of frame face or ceiling clearance.

Parallel Arm Allows closer to be installed 1/2" (13mm) higher up on door than standard parallel arm application.

Regular Arm

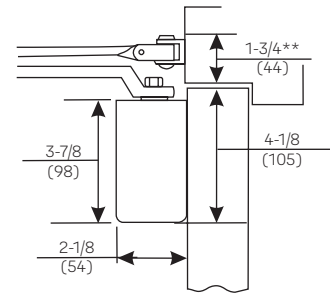
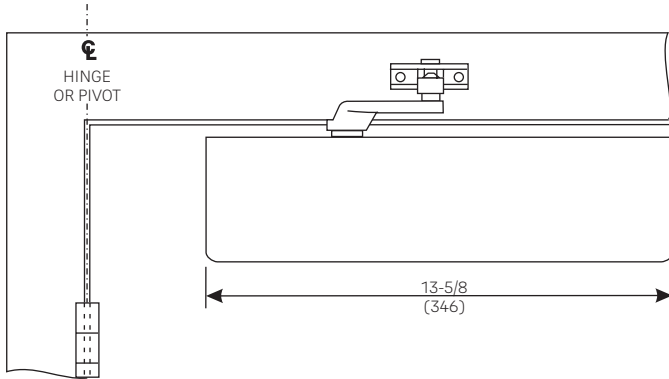

Mounting holes for closer body are spaced 2-3/8" (60mm) vertically x 6-3/4" (171mm) horizontally.

** This dimension will vary. Standard non-hold open arm illustrated.

Model Number	
Non-Hold Open	Hold Open
4400	4410

Standard Door Widths	
Interior	32" - 54" (81-137 cm)
Exterior	30" - 48" (76-122 cm)

Consult factory if door weight exceeds 250 lbs.

Top Jamb

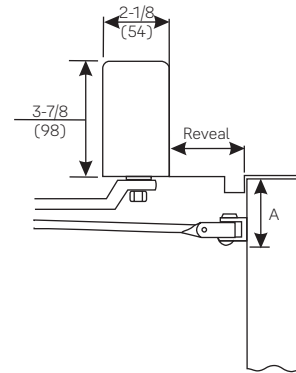
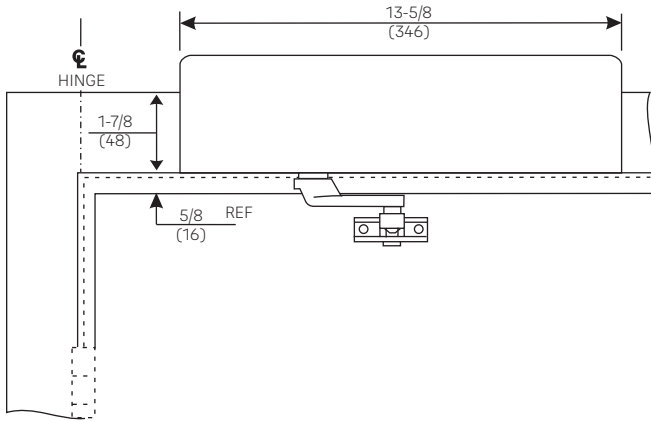

Mounting holes for closer body are spaced 2-3/8" (86mm) vertically x 6-3/4" (171mm) horizontally.
 ** Minimum frame face with 486 back plate. 3-1/4" (83mm) required when drop plate is not used.

Model Number	Reveal Range Inches (mm)	Maximum Door Opening
Non-Hold Open Arm		
4400/4400M	0" to 3" (0 to 76)	180°
TJ4400	2-3/4" to 7" (70 to 178)	150°
TJL4400	2-3/4" to 7" (70 to 178)	180°
TJL4480 x 487	0" to 2-3/4" (0 to 70)	180°
Hold Open Arm		
4410 4410M	0" to 3" (0 to 76)	180°
TJ4410	2-3/4" to 6-3/4" (70 to 171)	150°
TJL4410	2-3/4" to 6-3/4" (70 to 171)	180°

A Minimum top rail of door Inches (mm)					
Without drop plate or with 486 back plate			With 487 drop plate		
(TJ)4400	(TJ)4410	(TJ)4480	(TJ)4400	(TJ)4410	(TJ)4480
2" (51)	2-1/2" (64)	N/A	4-1/8" (105)	4-5/8" (117)	3-5/8" (92)

Model Number	
Non-Hold Open	Hold Open
(TJ)4400	(TJ)4410

Standard Door Widths	
Interior	32" - 54" (81-137 cm)
Exterior	30" - 48" (76-122 cm)

Consult factory if door weight exceeds 250 lbs.



Parallel Arm

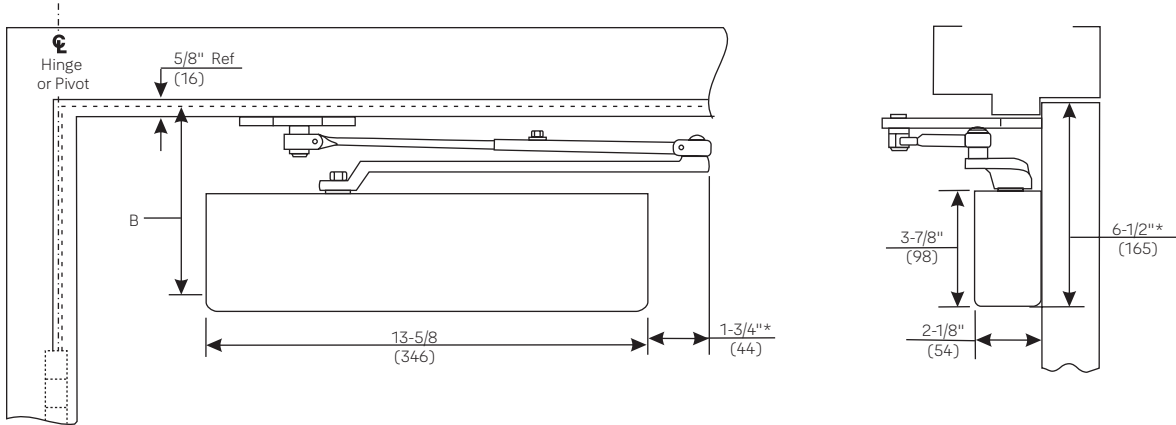

Mounting holes for closer body are spaced 2-3/8" (86mm) vertically x 6-3/4" (171mm) horizontally.
 ** This dimension will vary. Standard non-hold open arm illustrated.

B				
Minimum top rail of door with 5/8" (16mm) frame stop				
Inches (mm)				
4400	4410	PA4480	4410	PA4480
5-7/8" (149)	6-1/4" (159)	5-3/8" (137)	2-3/4" (70)	1-7/8" (48)

Model Number	
Non-Hold Open	Hold Open*
(PA)4400	(PA)4410

* Specify hand.

Standard Door Widths	
Interior	30" - 54" (76-137 cm)
Exterior	30" - 48" (76-122 cm)

Consult factory if door weight exceeds 250 lbs.

Parallel Rigid Arm

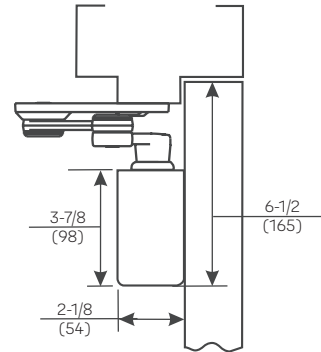
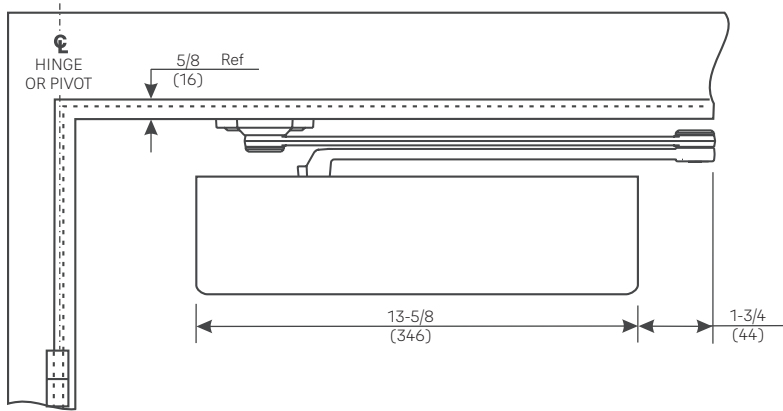

Mounting holes for closer body are spaced 2-3/8" (60mm) vertically x 6-3/4" (171mm) horizontally.

Model Number	
Non-Hold Open	Hold Open*
PR4400	PR4410

*Specify handing.

Standard Door Widths	
Interior	30" - 48" (76-122cm)
Exterior	32" - 48" (81-122cm)

Consult factory if door weight exceeds 250 lbs.



Holder/Stop Arm

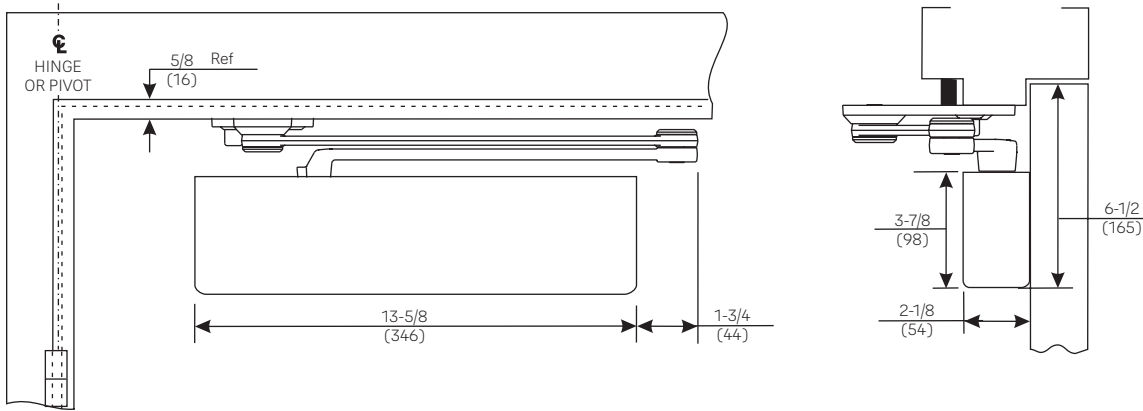

Mounting holes for closer body are spaced 2-3/8" (60mm) vertically x 6-3/4" (171mm) horizontally.

Model Number	
Non-Hold Open	Thumbturn Hold Open
4420	4420T

Standard Door Widths	
Interior	30" - 48" (76-122cm)
Exterior	32" - 48" (81-122cm)

Consult factory if door weight exceeds 250 lbs.

Holder/Stop Spring Arm

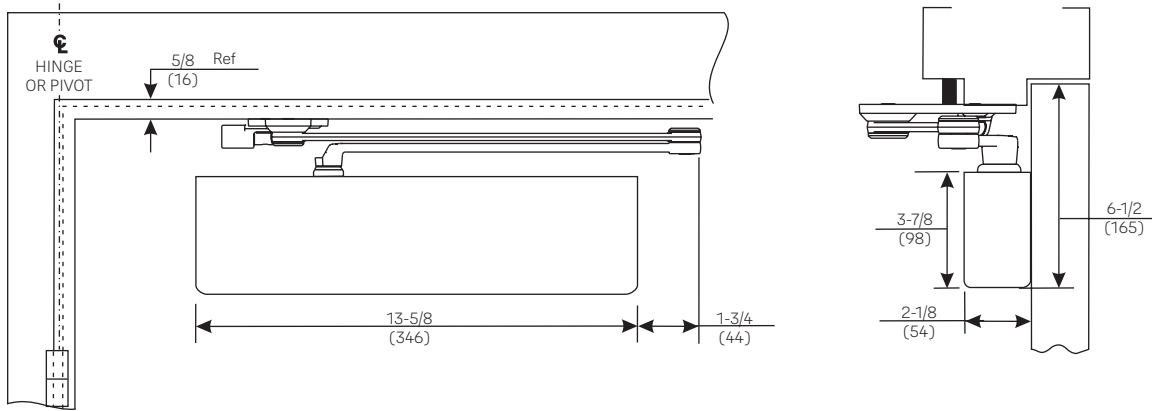

Mounting holes for closer body are spaced 2-3/8" (60mm) vertically x 6-3/4" (171mm) horizontally.

Model Number	
Non-Hold Open	Thumbturn Hold Open
4430	4430T

Standard Door Widths	
Interior	30" - 48" (76-122cm)
Exterior	32" - 48" (81-122cm)

Consult factory if door weight exceeds 250 lbs.



Regular Rigid Heavy-Duty Arm

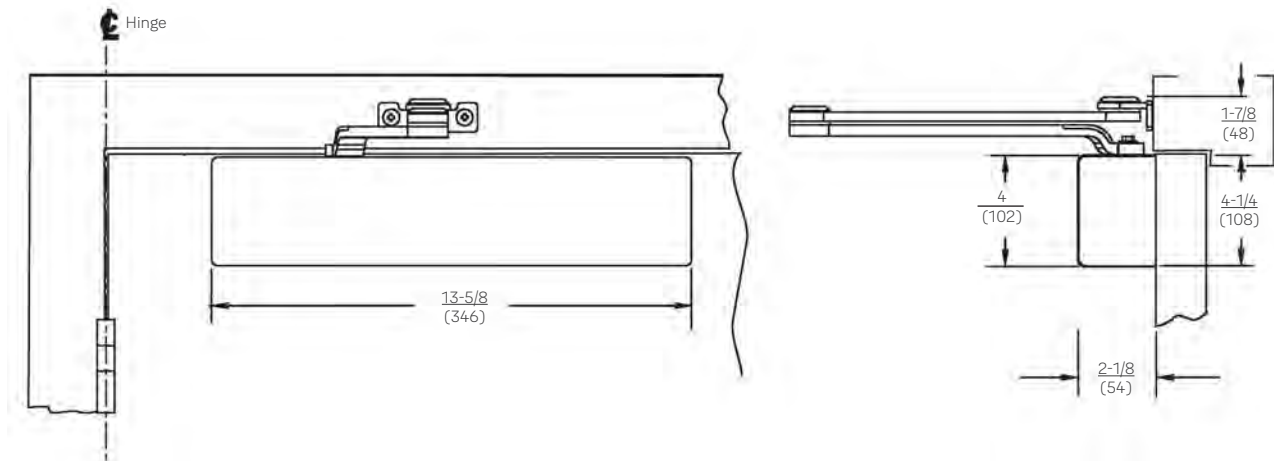

Mounting holes for closer body are spaced $2\frac{3}{8}$ " (60mm) vertically x $6\frac{3}{4}$ " (171mm) horizontally.

Model Number
Non-Hold Open
R4400

Standard Door Widths	
Interior	36" - 54" (91-137 cm)
Exterior	30" - 52" (76-132cm)

Consult factory if door weight exceeds 250 lbs.

UNI Stop™ Parallel Arm

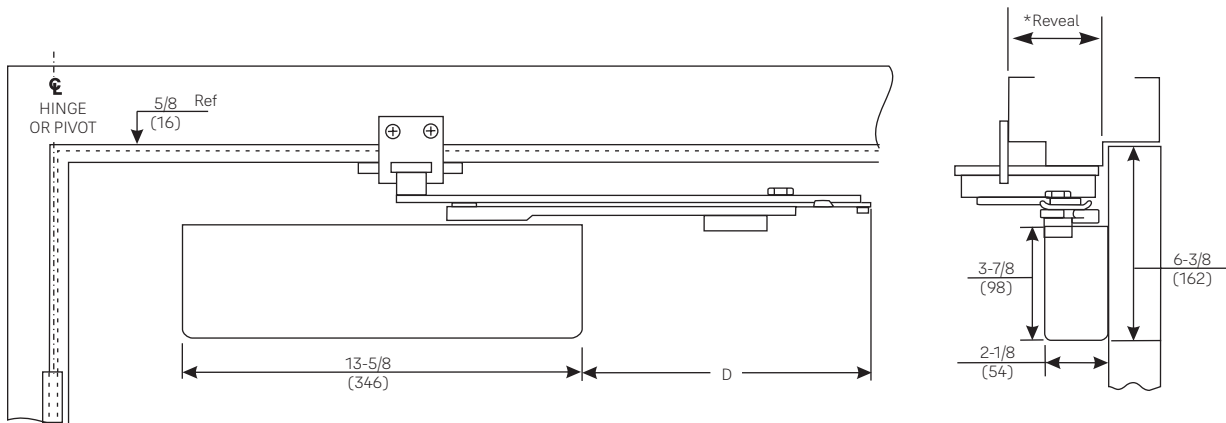

Mounting holes for closer body are spaced 2-3/8" (86mm) vertically x 6-3/4" (171mm) horizontally.

Door width must be specified when ordering.

* Reveals 1-7/8" to 4-5/8" (48mm to 117mm) standard, uses 6190 bracket.

Reveals in excess of 4-5/8" (117mm) requires use of 6191 reinforcing kit.

Reveals to 1/8" (3mm) requires use of 589L angle bracket.

Door Width Inches (cm)	D Arm Extension Beyond Closer
28-32" (71-81)	8-5/8" (219)
33-41" (84-104)	10-1/8" (257)
42-48" (107-122)	11-1/2" (292)

Model Number	
Non-Hold Open	Hold Open
UNI4400	UNI4410

x Specify Door Width

Standard Door Widths

30" - 48" (76-122cm)

Consult factory if door weight exceeds 250 lbs.

UNI Stop™ Top Jamb Arm

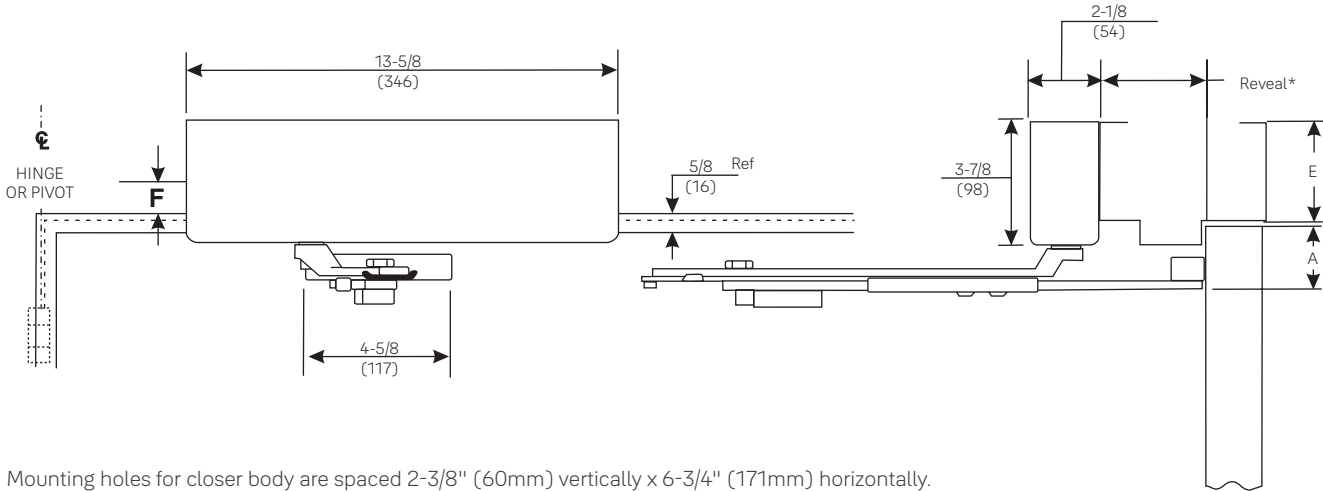

Mounting holes for closer body are spaced 2-3/8" (60mm) vertically x 6-3/4" (171mm) horizontally.

* Reveals up to a maximum of 7-3/8" (187mm).

Reveal must be specified when ordering

Backplates	F Minimum Frame Face	E Minimum Ceiling Clearance	A Minimum Top Rail Clearance
486 ¹	1-5/8" (41)	3-1/8" (79)	2-1/4" (57)
487		1-7/8" (48)	3-1/2" (89)

1. 486 backplate supplied standard with closer

Model Number	
Non-Hold Open	Hold Open
UNIJ4400	UNIJ4410
x Specify Frame Reveal	

Standard Door Widths

34" - 54" (86-137 cm)

Consult factory if door weight exceeds 250 lbs.

Push Side Slide Track

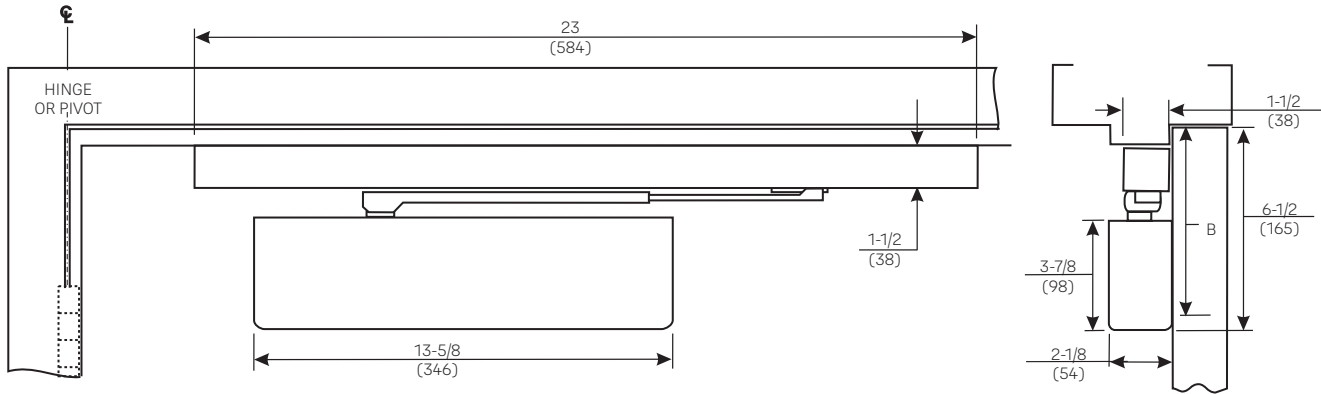

B Minimum top rail of door with frame stop Inches (mm)	
Without drop plate	With 488 drop plate
6" (152)	2-5/8" (67)

Model Number	
Non-Hold Open 85°-100°	Hold Open 85°-100°
P4400ST	P4410ST

Standard Door Widths	
Interior	32" - 48" (81-122cm)
Exterior	32" - 38" (81-97cm)

Consult factory if door weight exceeds 250 lbs.



Pull Side Slide Track

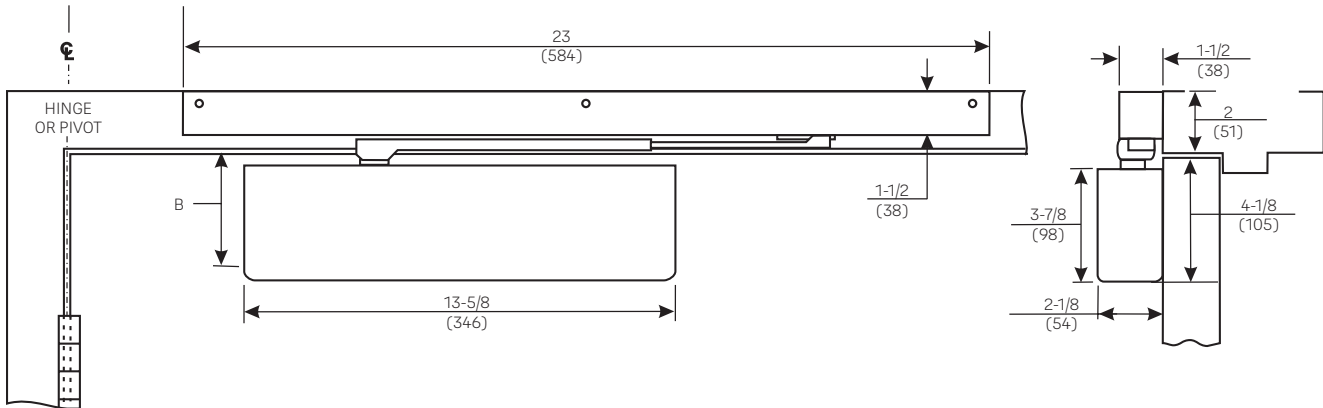

Mounting holes for closer body are spaced 2-3/8" (86mm) vertically x 6-3/4" (171mm) horizontally.

B Minimum top rail of door with frame stop Inches (mm)	
Without drop plate	With 488 drop plate
3-1/2" (111)	2-5/8" (67)

Model Number ^{1,2}		
Non-Hold Open		Hold Open
85°-100°	85°-180°	85°-100°
4400ST	4400ST-180	4410ST

Standard Door Widths	
Interior	32" - 48" (81-122cm)
Exterior	32" - 38" (81-97cm)

1-Units can be mounted with the closer body on the jamb. Prefix the model number with a "TJ". Where the frame face is less than 3-3/8" (86mm) a number 486JP backplate will be required.

2 - Units can also be installed on double egress doors using a handed arm that will accommodate the frame profile. Suffix the model number with "DE". For reveal ranges 1/4" to 3" (6 to 76mm).

Consult factory if door weight exceeds 250 lbs.

Regular Arm



Closer Mounting Plate

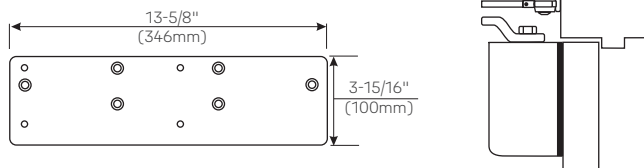

Narrow Frame (Top Rail) - 486 Drop Plate: For use where the narrow top rail of the door prevents the closer from being mounted directly to the door surface. This drop plate must be used for closer mounted on a top rail between 1-7/8" and 3-3/8" (48 and 86mm) in height.

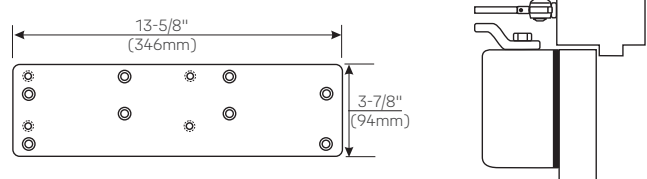

Overhead Door Holder - 486OH Drop Plate: For use when the presence of a surface or concealed overhead door holder prevents normal mounting of closer body due to interference between closer's mounting screws and door holder track. This drop plate's mounting screws are located on the door surface 2-3/8" down from the frame rabbet allowing room for placement of the surface mounted or overhead concealed door stop/holder.

Brackets For Non-Hold Open Arms

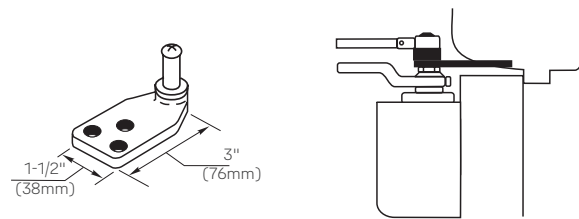

Molded/Bull Nose Trim - 291: For use where the door frame has molded or bull nose trim which will not accept a standard non-hold open shoe. The bracket is mortised into the frame rabbet, and projects beyond the face of the frame. It will accommodate a frame rabbet up to 2" (51mm) deep.

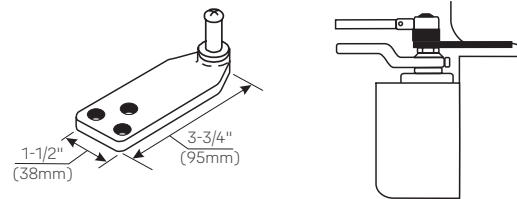

Molded/Bull Nose Trim - 291A Bracket: This bracket is similar to – but longer than – the 291 bracket. It is designed to accommodate frame rabbets from 2" to 2-7/8" (51 to 73mm) deep.

Brackets For Hold Open Arms

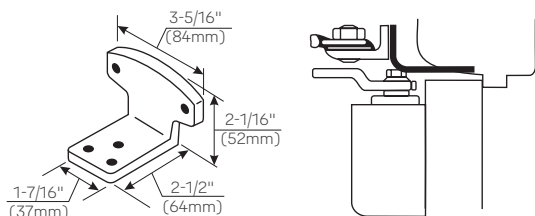

Molded/Bull Nose Trim - 292 Bracket: For use where the door frame has molded or bull nose trim which will not accept a standard hold open shoe. It is mortised into the frame rabbet, and projects beyond the face of the frame. It will accommodate a rabbet up to 2" (51mm) deep. This bracket is used in combination with the standard hold open mounting shoe.



Regular Arm

Corner Brackets For Closer Mounting

For closer sizing information use the Parallel Arm Sizing Chart on page 17. The use of a corner bracket requires a door closer of the opposite hand from that of the door when ordering handed closers.

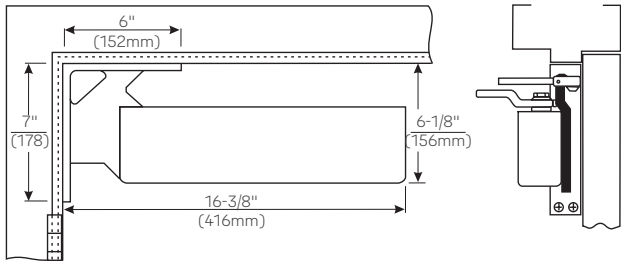

Mounting Opposite Hinge Side - 498 Standard Drop Corner Bracket: For use where it is desired to mount a regular arm non-hold open closer.

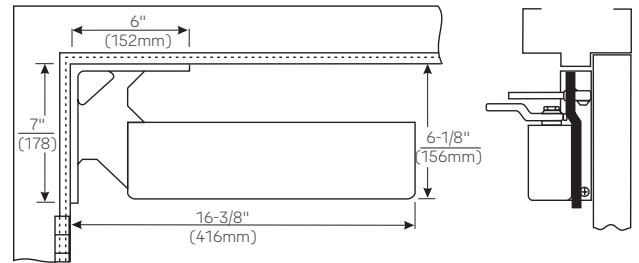

Extra-Drop Mounting Opposite Hinge Side - 2498 Corner Bracket: For use where it is desired to mount a regular arm hold open closer, or where it is necessary for a regular arm non-hold open closer to clear a separate overhead door holder. This bracket drops the closer 1-1/8" (29mm) lower than the 498 Corner Bracket.

Top Jamb

Closer Mounting Plates

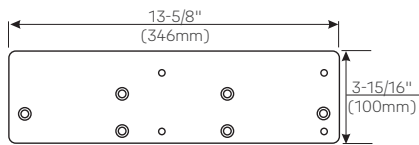

Narrow Frame - 486 Back Plate: For use where a narrow frame face prevents the closer from being mounted directly to the frame. This back plate must be used for closer mounted on a frame between 1-7/8" and 3-1/8" (48 and 79mm) in height.

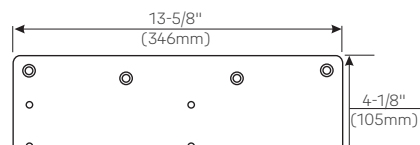

Low Ceiling Clearance - Overhead Door Holder - 487 Drop Plate: For use where the ceiling clearance is between 1-7/8" and 3-7/8" (48 and 98mm) or where a surface or concealed overhead door holder prevents normal top jamb mounting. This plate drops the closer and allows the arm mounting screws to clear the bottom of the door holder. This places the centerline of the arm mounting screws at 3-1/8" (79mm) from the top of the door.

Parallel Arm



Closer Mounting Plate

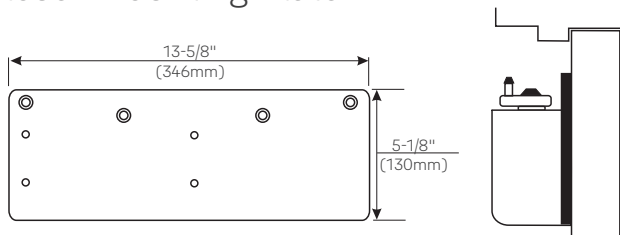

Narrow Top Rail - 488 Drop Plate: For use where a narrow top rail prevents the closer from being mounted directly to the door surface. This drop plate can be used to mount a closer on a top rail as narrow as 2-1/2" (64mm) in height.

Brackets For Non-Hold Open Arms

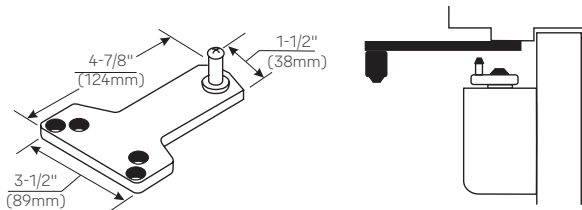

Standard Installation - 289 Soffit Plate: This soffit plate is supplied standard with parallel arm closers. It can be mounted where the frame soffit is as narrow as 1" (25 mm).
Specify 289A-SS for stainless steel soffit plate.

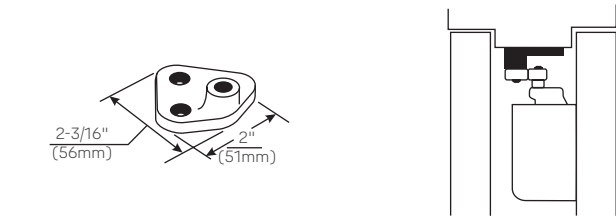

Mounting Between Doors - 413A Soffit Bracket: For use where insufficient space between companion doors does not permit use of other soffit plates. This bracket permits mounting of the closer between doors with as little as 3" (76mm) of header space. Permits closer arm to clear up to 5/8" (16mm) high stop.

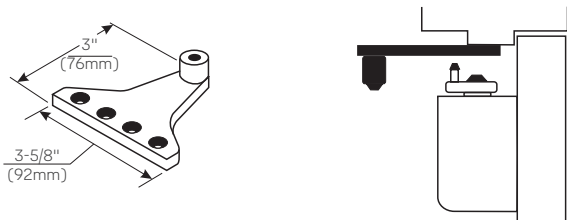

Narrow Frame/Removable Stop - 297 Soffit Plate: For use where a narrow frame or frame with removable stop does not permit use of the standard soffit plate. This soffit plate may be mounted on the frame soffit or the frame rabbet where the stop does not exceed 5/8" (16mm) in height. All of the screw holes are in a straight line, requiring as little as 1-1/4" (32mm) of frame reveal to mount bracket and maintain good closer arm geometry. Where the frame soffit is as wide as 2" (51mm), this soffit plate may be used to clear weather-stripping that is up to 1-3/8" (35mm) wide and 5/8" (16mm) in height.

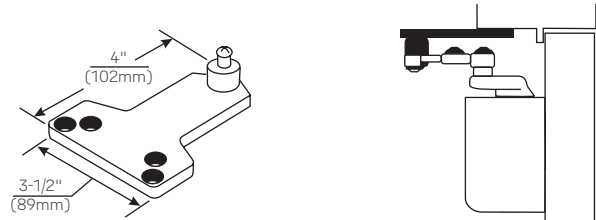

Blade/Applied Stop - 299 Soffit Plate: For use where a blade or applied stop does not permit installation of the standard soffit plate. Mounts to either the frame soffit or rabbet. Since this soffit plate projects 7/8" (22mm) less than a standard soffit plate, it requires a minimum frame reveal of 1-1/2" (38mm). Permits closer to clear up to a 5/8" (16mm) stop.



Parallel Arm

Brackets For Non-Hold Open Arms (Continued)

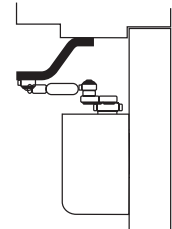
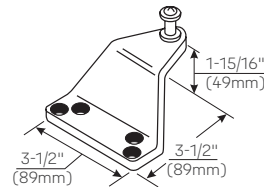
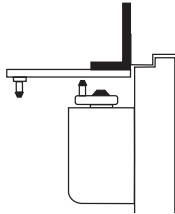
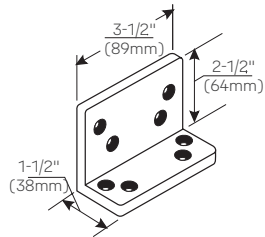

Flush Transom - 589L Angle Bracket: For use where rabbeted or flush transom conditions prevent installation of a soffit plate. Used in combination with the 289 soffit plate, or may be used in combination with the 290 soffit plate when it is necessary for the closer arm to clear a separate overhead door holder.

Extra-Clearance - 290 Offset Soffit Plate: For use where the need for additional clearance prevents use of the standard soffit plate. This plate mounts to the frame soffit to provide up to 2" (51mm) of clearance when a separate overhead door holder is used. Standard mounting requires a 2-5/8" (67mm) wide frame soffit. It may also be used where unusually high frame stops or weather-stripping prevent the use of other soffit plates.

Brackets For Hold Open Arms

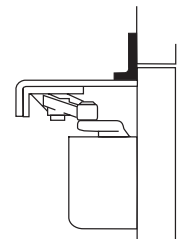
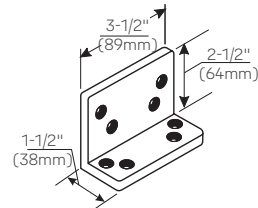
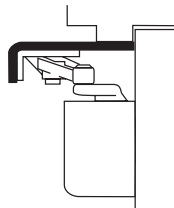
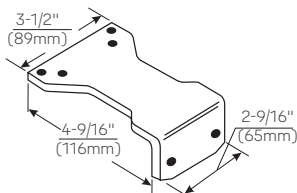

Parallel Hold Open - 588 Adapter Plate: This adapter plate is supplied standard with all parallel arm hold open closers. It can also be used to convert regular arm or top jamb hold open arms to parallel arm installation. It can be mounted where the frame soffit is as narrow as 1" (25mm).

Flush Transom Hold Open - 589L Angle Bracket: For use where rabbeted or flush transom conditions prevent installation of the standard 588 hold open adapter plate. It is used in combination with the 588 adapter plate.

Parallel Rigid Arm



Closer Mounting Plate

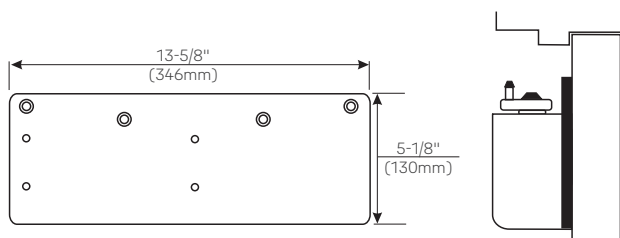

Narrow Top Rail - 488 Drop Plate: For use where a narrow top rail prevents the closer from being mounted directly to the door surface. This drop plate can be used to mount a closer on a top rail as narrow as 2-1/2" (64mm) in height.

Brackets For Non-Hold Open Arms & Hold Open Arms

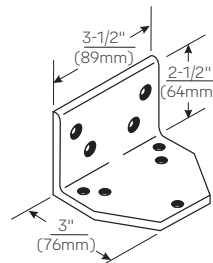
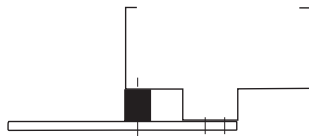
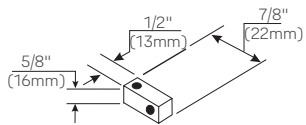

Standard - 293S Spacer Block: For use where a narrow frame soffit does not provide adequate support for the soffit plate. Supplied as standard with all parallel rigid arm closers.

Flush Rabbeted Transom - 293L Angle Bracket: For use where flush transom conditions prevent mounting of the standard soffit plate. This bracket is used in combination with the standard soffit plate.

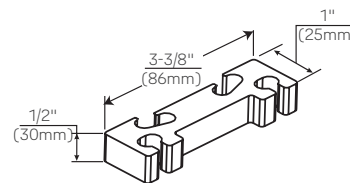
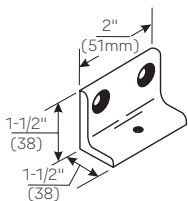

Narrow Frame - 890 Support Bracket: For use where the frame is narrow, and the soffit plate cannot be mounted directly to the frame soffit or rabbet. Used in combination with the #891 spacer block on blade stop frames to provide extra support and needed clearance of the blade stop.

Clearance/Support Blade Stop - 891 Spacer Block: For use where the door frame has a blade stop and the soffit plate must be mounted on the frame rabbet. This accessory is used in combination with the standard spacer block to provide clearance of the blade stop.



Parallel Rigid Arm

Closer Mounting Plate

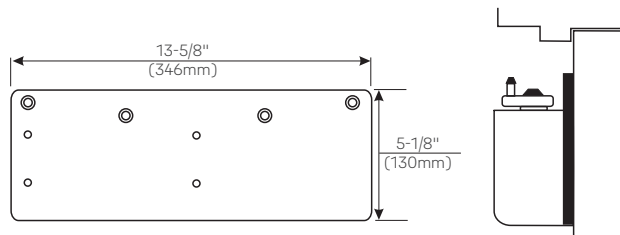

Narrow Top Rail - 488 Drop Plate: For use where a narrow top rail prevents the closer from being mounted directly to the door surface. This drop plate can be used to mount a closer on a top rail as narrow as 2-1/2" (64mm) in height.

Brackets For Non-Hold Open Arms & Hold Open Arms

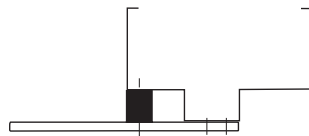
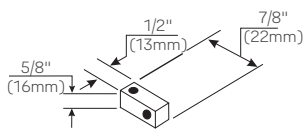

Standard - 293S Spacer Block: For use where a narrow frame soffit does not provide adequate support for the soffit plate.

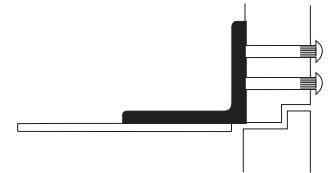
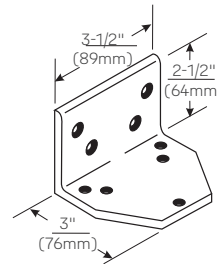

Flush Rabbeted Transom - 293L Angle Bracket: For use where flush transom conditions prevent mounting of the standard soffit plate. This bracket is used in combination with the standard soffit plate.

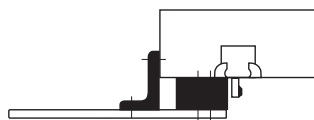
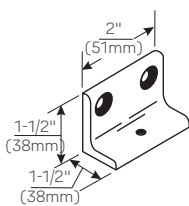

Narrow Frame - 890 Support Bracket: For use where the frame is narrow, and the soffit plate cannot be mounted directly to the frame soffit or rabbet. Used in combination with the #891 spacer block on blade stop frames to provide extra support and needed clearance of the blade stop.

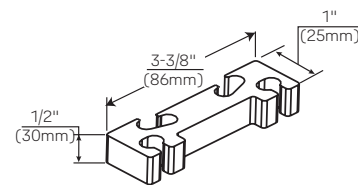

Clearance/Support Blade Stop - 891 Spacer Block: For use where the door frame has a blade stop and the soffit plate must be mounted on the frame rabbet. This accessory is used in combination with the standard spacer block to provide clearance of the blade stop.

UNI Stop™ Arm



Closer Mounting Plate (For Parallel Arm)

Narrow Top Rail - 488 Drop Plate: For use where a narrow top rail prevents the closer from being mounted directly to the door surface. This drop plate can be used to mount a closer on a top rail as narrow as 2-3/8" (60mm) in height.

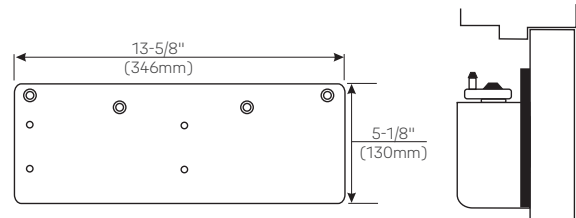

Soffit Plate Reinforcing Brackets (For Parallel Arm)

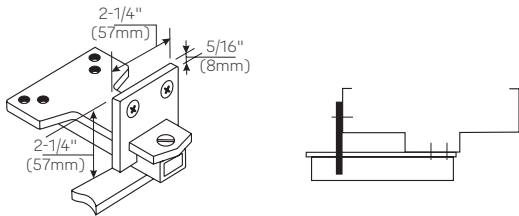

Additional Support - 6190 Reinforcing Bracket: Standard for use with all Parallel Arm UNI Stop Door Controls. Provides additional support to the soffit plate on installations with door frame reveals from 1-7/8" to 4-5/8" (48 to 117mm).

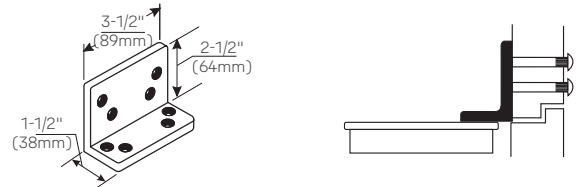

Flush Rabbeted Transom - 589L Angle Bracket: Optional for use with all Parallel Arm UNI Stop Door Controls. For use where rabbeted or flush transom conditions prevent installation of the soffit plate assembly. This bracket fastens to the overhead transom to provide a mounting surface for the soffit plate assembly.

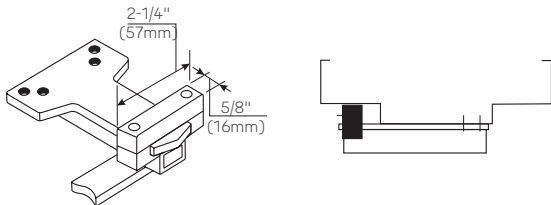

Wide Frame - 6191 Reinforcing Kit: Optional for use with all Parallel Arm UNI Stop Door Controls. Used to support the soffit plate on installations with wide frames. Clamps may be used with or without the spacer block, depending on frame conditions.

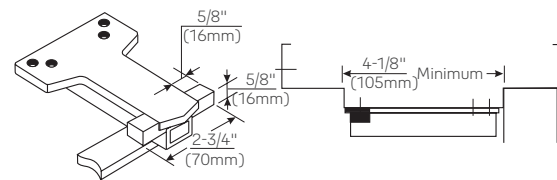

Closer Mounting Plates (For Top Jamb)

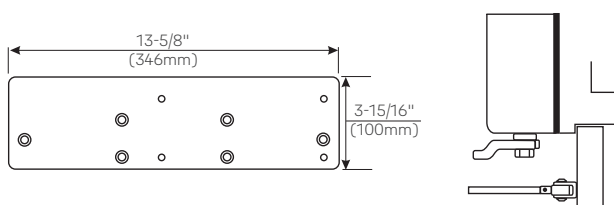

Standard Installation - 486 Back Plate: Can be mounted where a frame face is as narrow as 1-5/8" (41mm) in height.

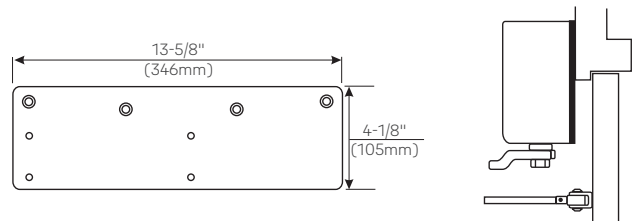

Minimum Ceiling Clearance - 487 Drop Plate: For use where the ceiling clearance is as little as 1-7/8" (48mm).



Slide Track

Closer Mounting Plate

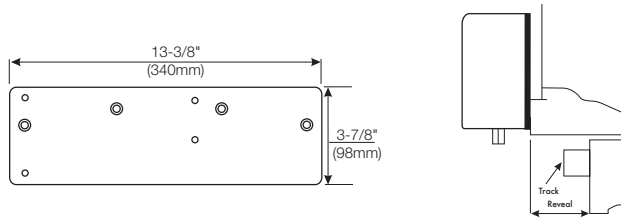

Slide Track - 486JP Back Plate: Required for frames with standard 2" (51mm) profile face. Without plate, minimum 4" (102mm) face frame required.

Retrofit Plates



Model Number	Replaces
RP44-4040	LCN-4040
RP44-4010	LCN-4010

The retrofit plates allow a 4400 Institutional Door Closer to replace 4040 or 4010 closer without modifying the existing hole pattern in the door. The plates will work with regular and parallel arm applications.

Note: The location of the arm shoe on the frame will change, therefore the frame must be patched.

Door Closer Body Assemblies

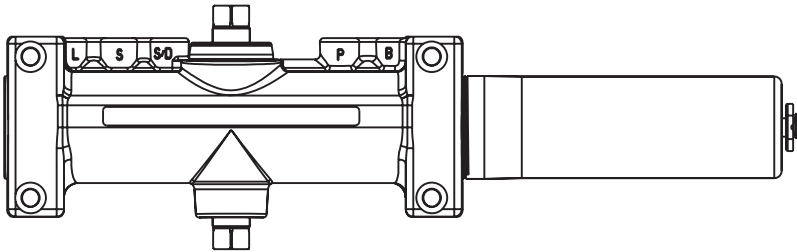

Closer Series	Closer Covers (Material)	Model Number	Dimensions Inches (mm)
4400 TJ4400	Plastic	400P	13-3/4" (349) x 4" (102) x 2-1/8" (54)
4400	Metal	400M	13-5/8" (346)
TJ4400	Metal	TJ400M x Hand	x 3-7/8" (98) x 2-3/16" (56)

Model Number	Description
4400LAP	Multi Size Closer Body
4400SLAP	Corrosion Resistant Body

LAP = Less All Parts

Specialty Fasteners

Steel Door Application

Sex Nut/Sleeve Nut & Screw:
"SNB" (4 per pack)

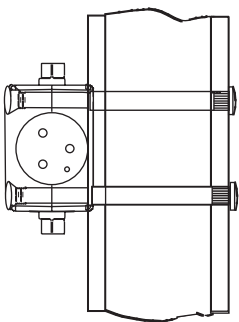

Door Thickness	SN's	SNB's
1-3/4"	SN-134	SNB134-47
2"	N/A	SNB200-47
2-1/4"	SN-214	SNB214-47
S.S. SNB'S 1-3/4" (Stainless Steel)	SN-134SS	SNB134SS-47

Aluminum and Wood Door Application (Aluminum Door Shown)

Sex Nut/Sleeve Nut: "SN"
(4 per pack)

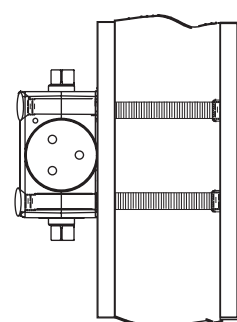

Thru-Bolt & Grommet Nut:
"TBGN" (4 per pack)

Door Thickness	TBGN's
1-3/8"	TBGN138-47
1-3/4"	TBGN134-47

Torx® Screw Packs

Arm Type	400/4400 Series
Regular, Parallel and Top Jamb	TX47
Parallel Rigid, Holder/Stop, Holder/Stop Spring	PRTX47
Regular Rigid Heavy-Duty Arm	RTX47
UNI Stop™ Arm	UNITX47

Non-Hold Open Arm Assemblies

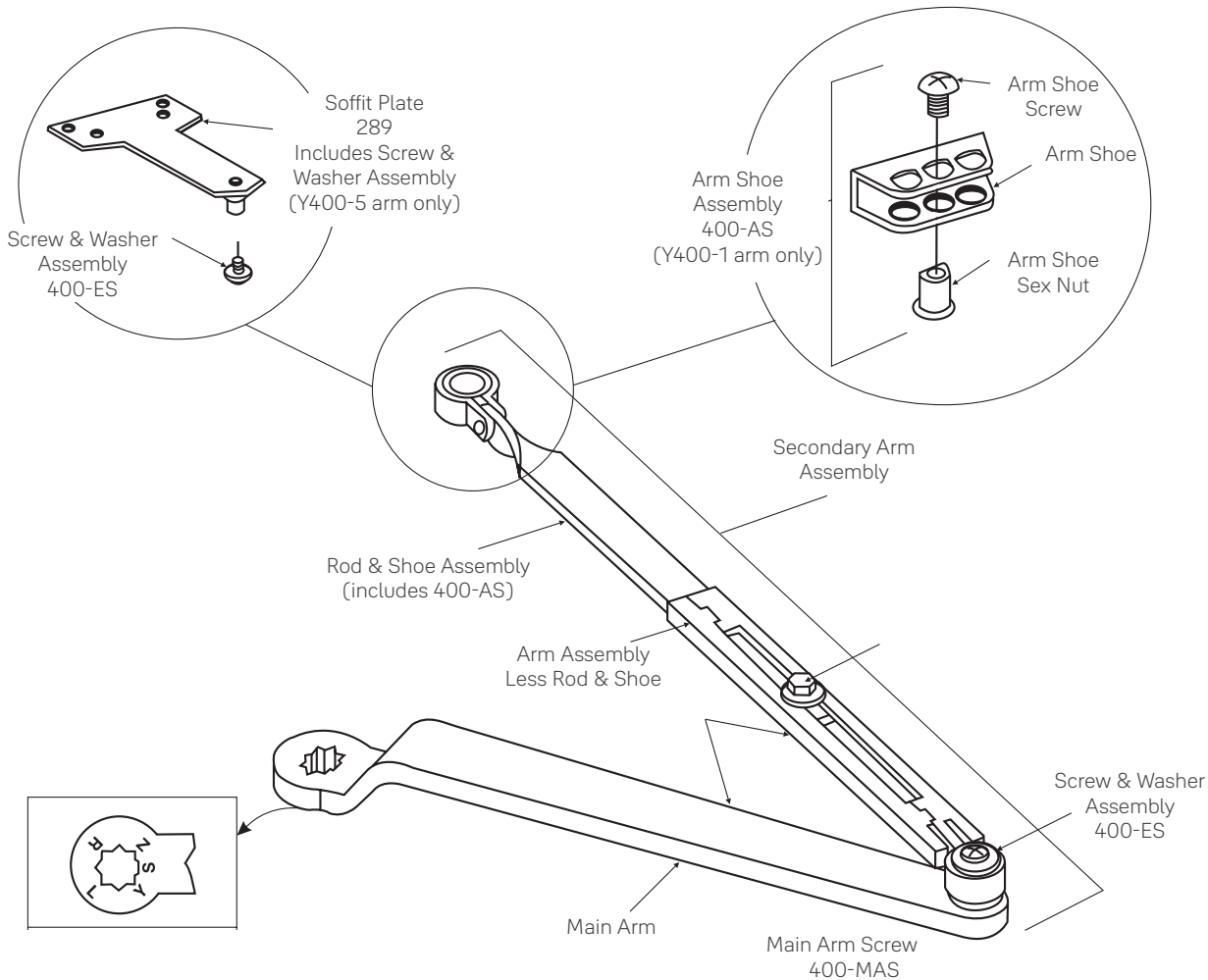

Closer Series	Complete Arm Assembly	Main Arm Assembly ¹ (includes 400-ES) Inches (mm)	Secondary Arm Assembly (includes 400-ES)	Arm Assembly Less Rod and Shoe	Rod & Shoe Assembly ² Inches (mm)
4400	Y400-1	400-1M (11)(279)	Y400-111	Y400-1W	Y400-11 (8-7/8)(225)
TJ4400	Y400-1A		Y400-121		Y400-11A (12-9/16)(319)
TJL4400	Y400-1B	400-2M (13-1/2)(343)	Y400-131	Y400-2W	Y400-11B (15-3/16)(386)
PA4400	Y400-5	400-1M (11)(279)	Y400-115	Y400-1W	Y400-15 (8-7/8)(225)
PA4400 ³	Y400-5A		Y400-115A		Y400-15A (12-9/16)(319)
4400	Y400-25 (tri pack includes Y400-1 plus 289 plate)	<ol style="list-style-type: none"> 1. C to C length shown in parentheses. 2. C of connecting link to end of rod shown in parentheses. 3. For 180° door swing when using a special template for doors hung on 6" to 8" (152mm to 203mm) wide throw hinges. 			

Note: Mounting hardware included with all parts orders.

Stainless Steel Arm Assemblies

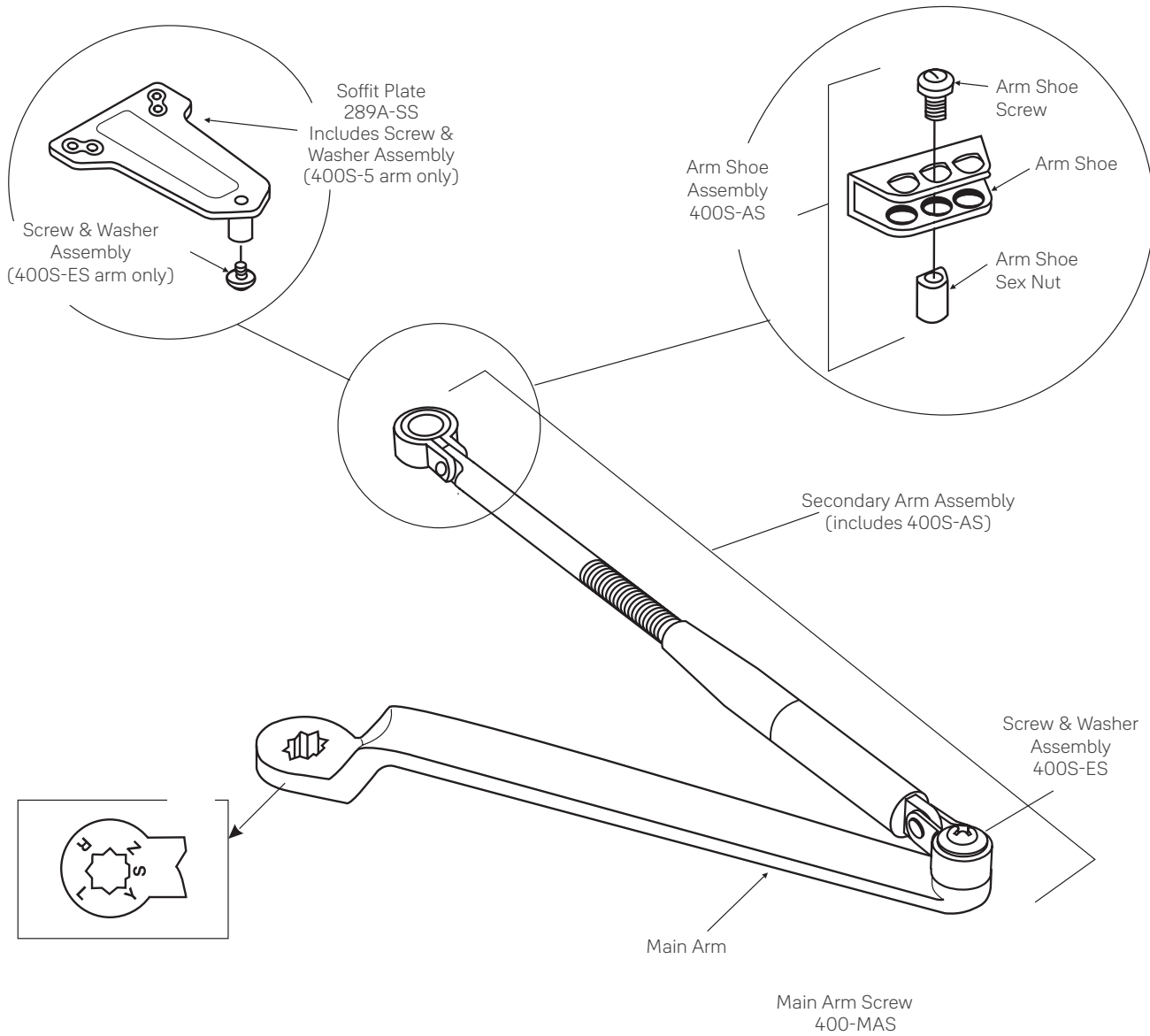

Closer Series	Complete Arm Assembly	Main Arm Assembly ¹ (length)(mm) (includes 400S-ES)	Secondary Arm Assembly (includes 400S-ES)
4400S	400S-1	400S-1M (11)(279)	400S-111
TJ4400S	400S-1A		400S-121
PA4400S	400S-5		400S-115

Note: Mounting hardware included with all parts orders.
1. C to C length shown in parentheses.

Hold Open Arm Assemblies

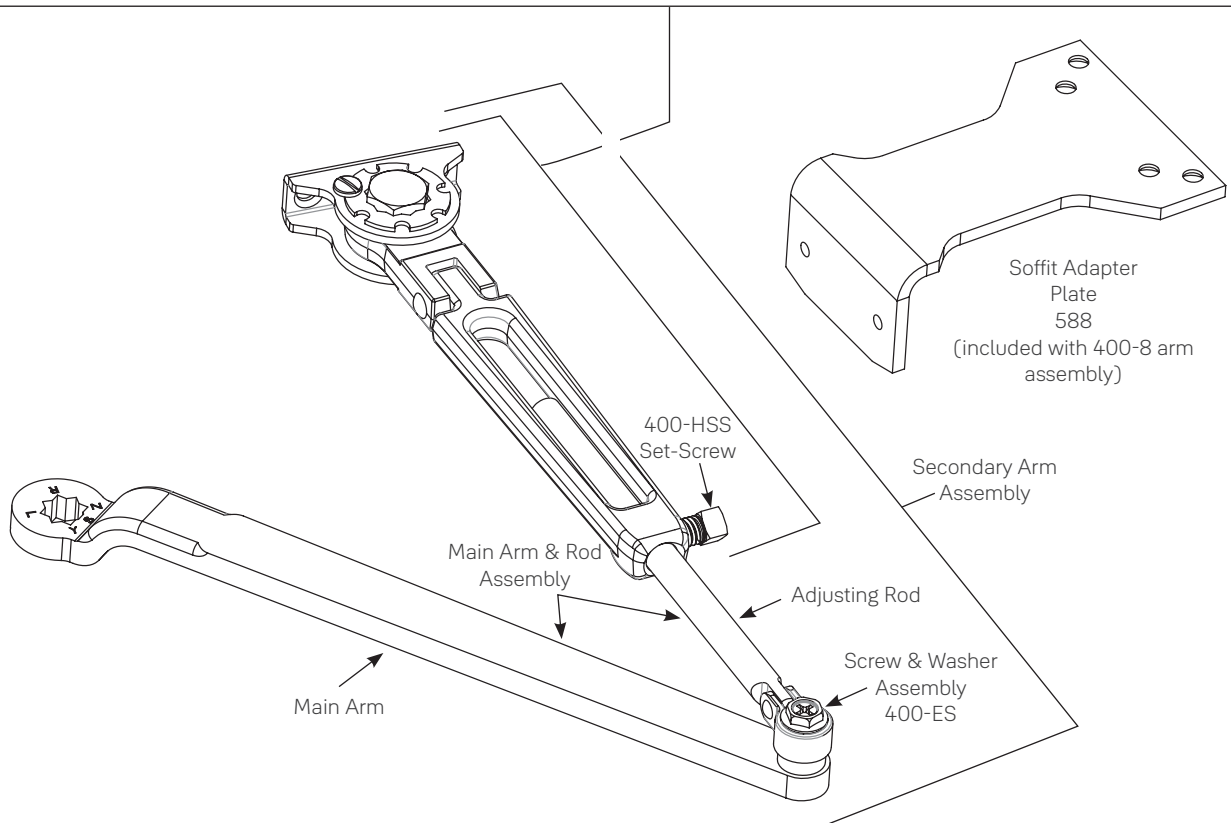
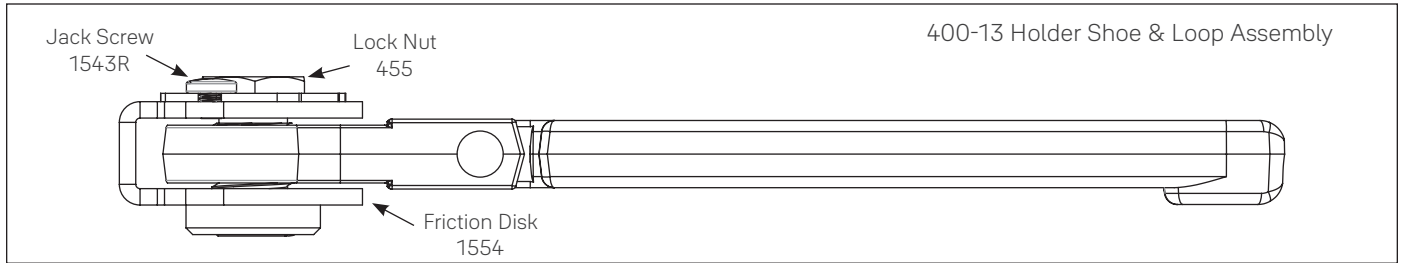

Closer Series	Complete Arm Assembly	Main Arm ¹ (Length)(mm) (includes 400-ES)	Secondary Arm (includes 400-ES)	Main Arm & Rod Assembly	Holder Shoe & Loop Assembly	Adjusting Rod ² (Length)(mm)
4410	400-3/400-8 ³	400-1M (11)(279)	400-113/400-118 (Reg.) / (Par.)	400-3W	400-13	400-31 (7-3/8)(187)
TJ4410	400-3A		400-123	400-3WA		400-31A (10-13/16)(275)
TJL4410	400-3B	400-2M (13-1/2)(343)	400-133	400-3WB		400-31B (12-7/8)(327)

Note: Mounting hardware included with all parts orders.

1. C to C length shown in parentheses.

2. C of connecting of connecting link to end of rod shown in parentheses.

3. Same as 400-3 but includes #588 soffit adapter plate.

Parallel Rigid Arm Assemblies



Non-Hold Open

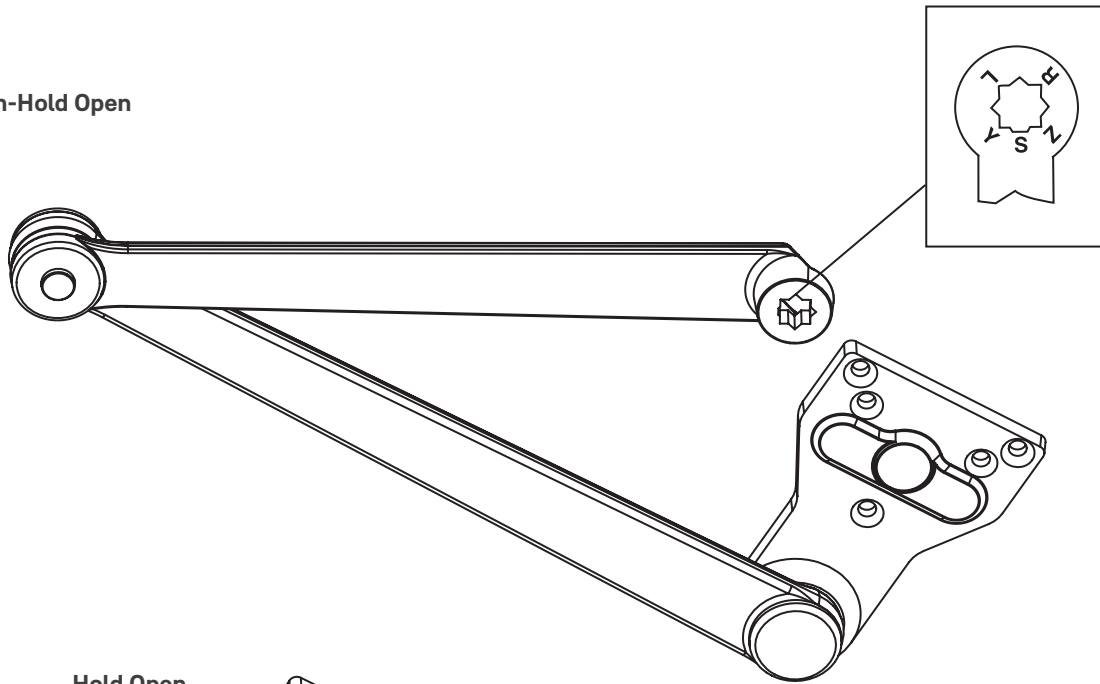

Hold Open

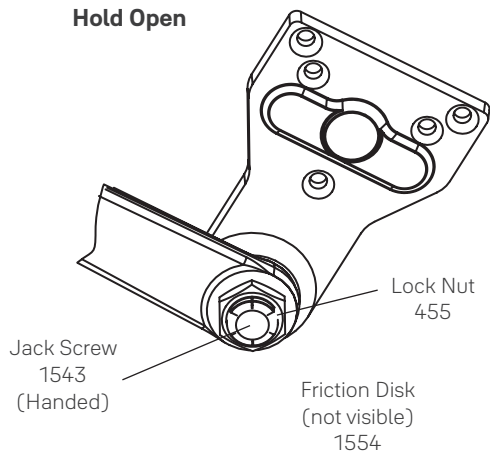

Arm Function	Complete Arm Assembly	Jack Screw
Non-Hold Open	PR400-5	N/A
Hold Open	PR400-8R (Right Hand)	1543R
	PR400-8L (Left Hand)	1543L

Note: Mounting hardware included with all parts orders.

Holder Stop Arm Assemblies

Hold Open Arm Shown

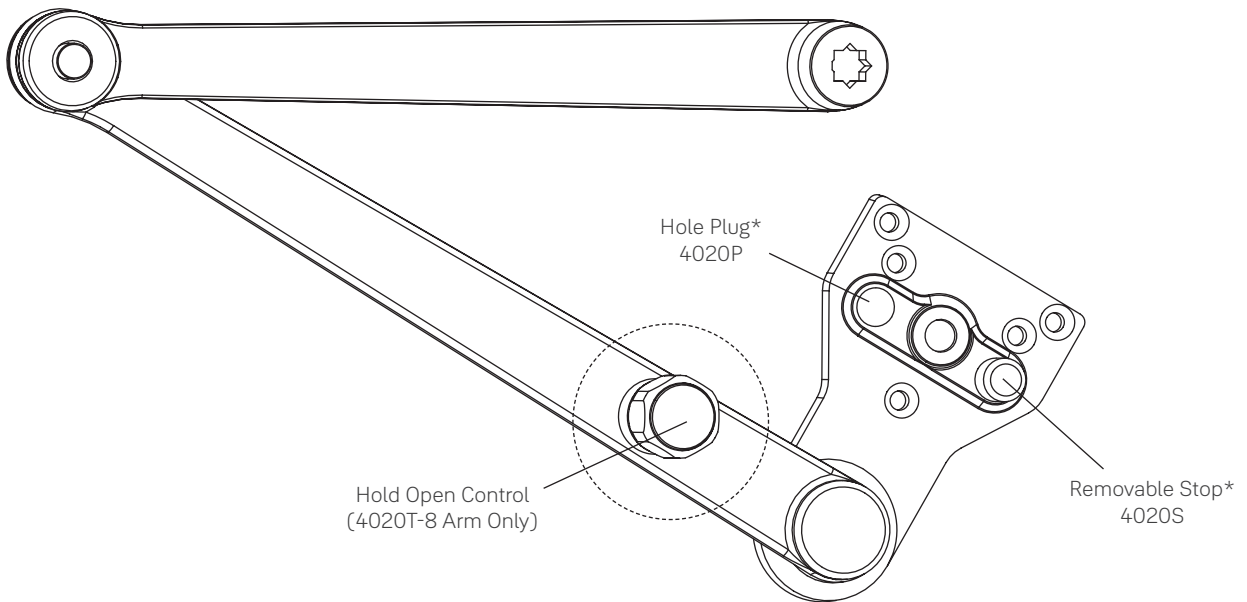

Arm Function	Complete Arm Package
Non-Hold Open	4020-5
Thumbturn Hold Open	4020T-8

Note: Mounting hardware included with all parts orders.

* These parts and screw pack are included with complete arm assemblies

Holder/Stop Arm Assemblies



Non-Hold Open Arm Shown

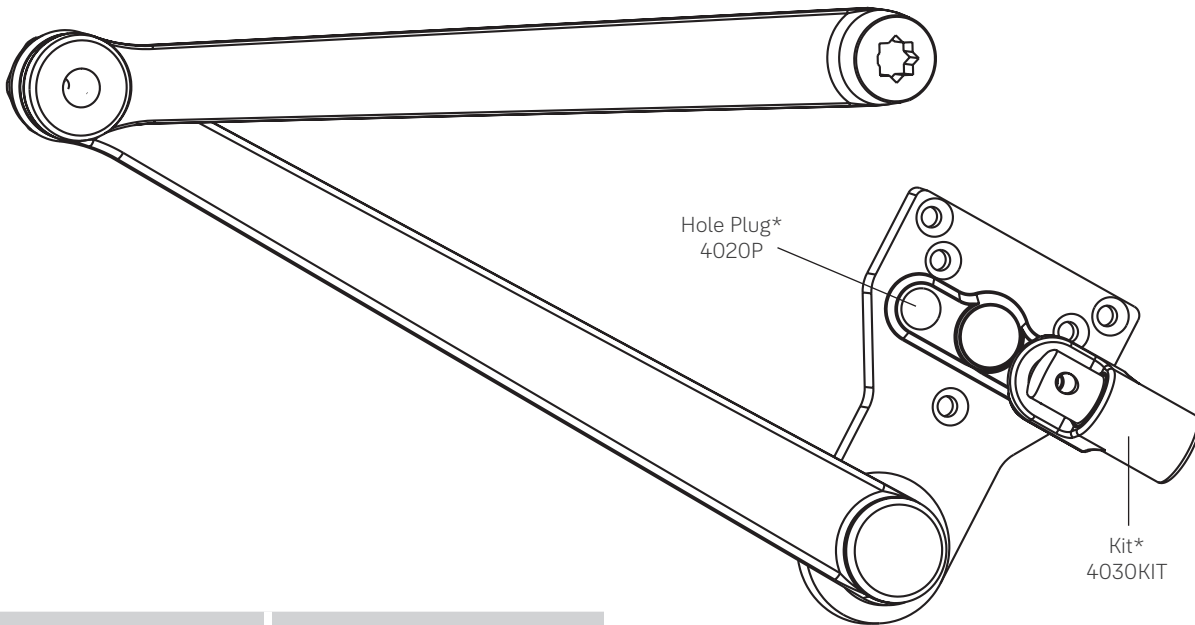

Arm Function	Complete Arm Package
Non-Hold Open	4030-5
Thumbturn Hold Open	4030T-8

Note: Mounting hardware included with all parts orders.

* These parts and screw pack are included with complete arm assemblies

Regular Rigid Heavy-Duty Arm Assemblies

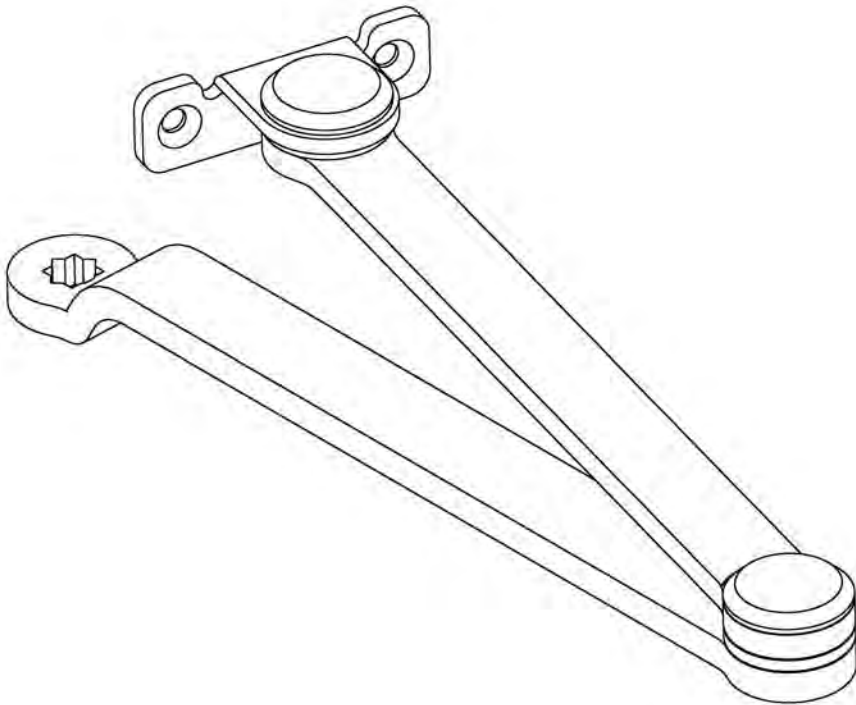

Closer Series	Arm Function	Complete Arm Package
R4400	Non-Hold Open	R400-1

Note: Mounting hardware included with all parts orders.

UNI Stop™ Arm Assemblies



Parallel Applications

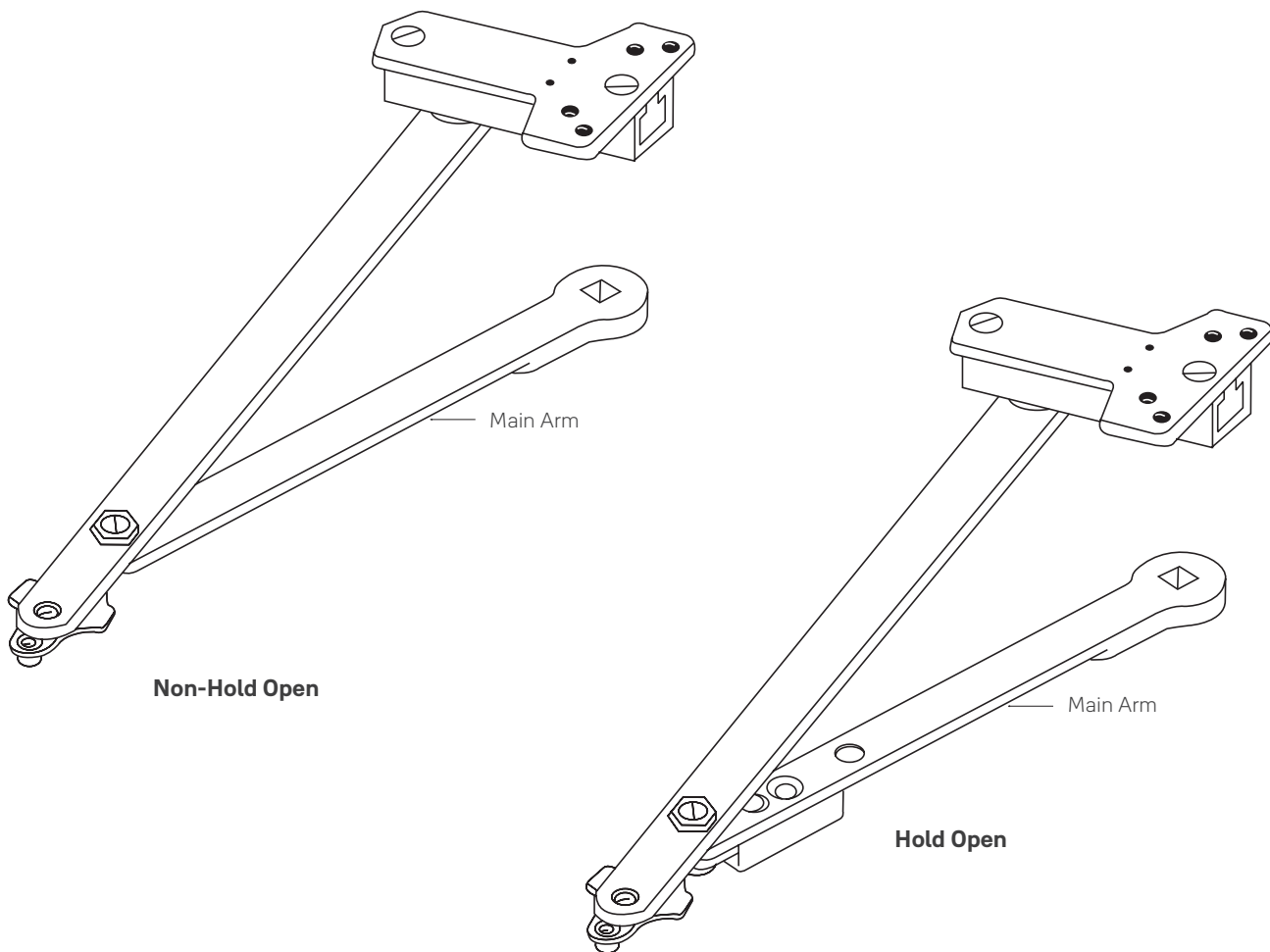

Complete Arm Assembly		Door Width (cm)	Main Arm Length* (mm)
Non-Hold Open	Hold Open		
6100-11	6100-1	28" - 32" (71- 81)	9-1/2" (241)
6100-13	6100-3	33" - 41" (84 - 104)	11" (279)
6100-14	6100-4	42" - 48" (107 - 122)	12-1/2" (318)

* Center to center length.

Notes:
Mounting hardware included with all parts orders.
Only available in painted finishes.



UNI Stop™ Arm Assemblies

Top Jamb Applications

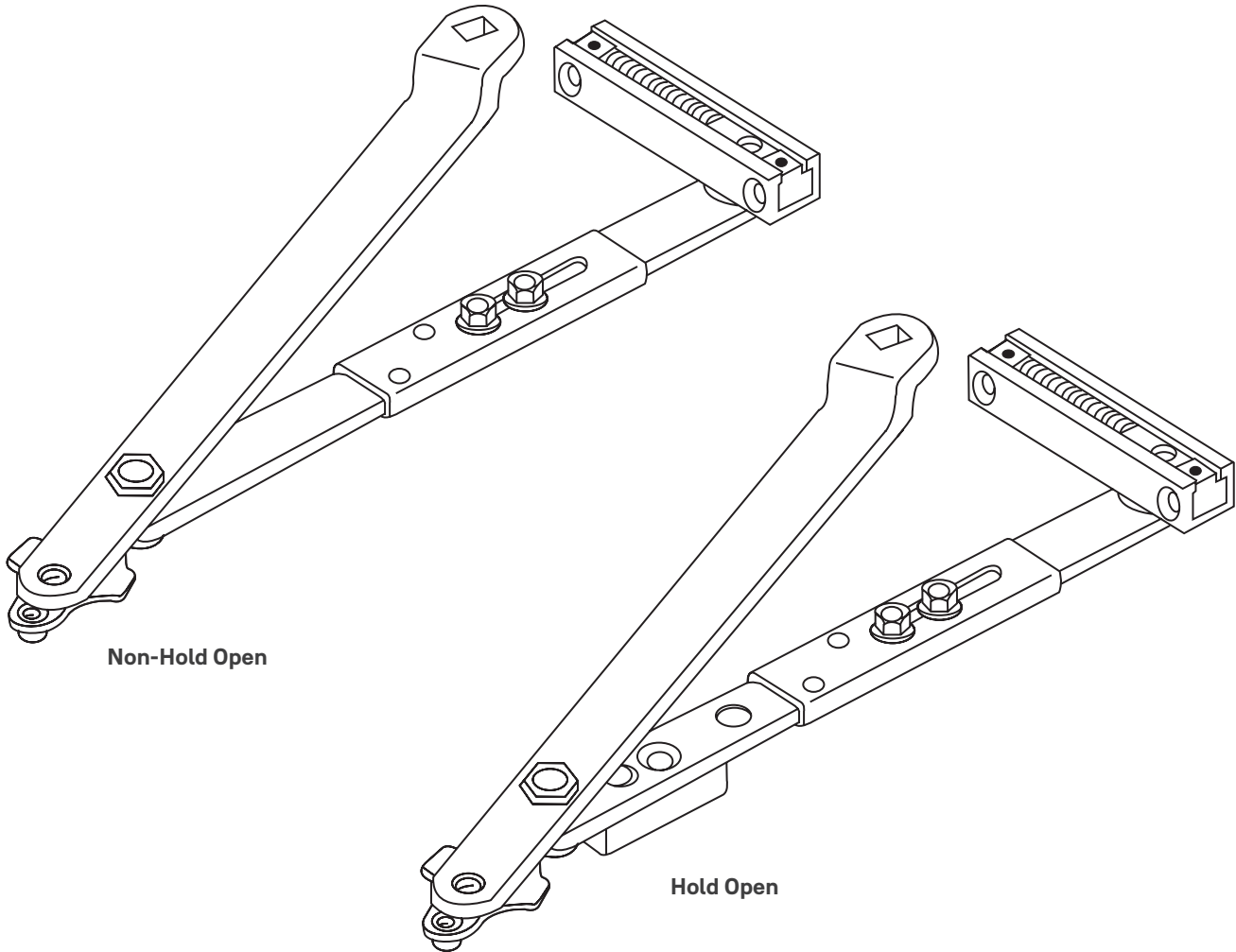

Complete Arm Assembly		For Frame Reveals (mm)
Non-Hold Open	Hold Open	
J6100-4	J6100-7	2-1/8" - 3-1/4" (54 - 83)
J6200-4	J6200-7	1/2" - 2" (13 - 51)
J6400-4	J6400-7	3-3/8" - 4-1/4" (86 - 108)
J6500-41	J6500-71	4-3/8" - 5-3/8" (111 - 137)
J6500-42	J6500-72	5-1/2" - 6-3/8" (140 - 162)
J6500-43	J6500-73	6-1/2" - 7-3/8" (165 - 187)
J6600-4	J6600-7	0" - 3/8" (0 - 10)

Notes:
 Mounting hardware included with all parts orders.
 Only available in painted finishes.

Low Profile Arm Assemblies

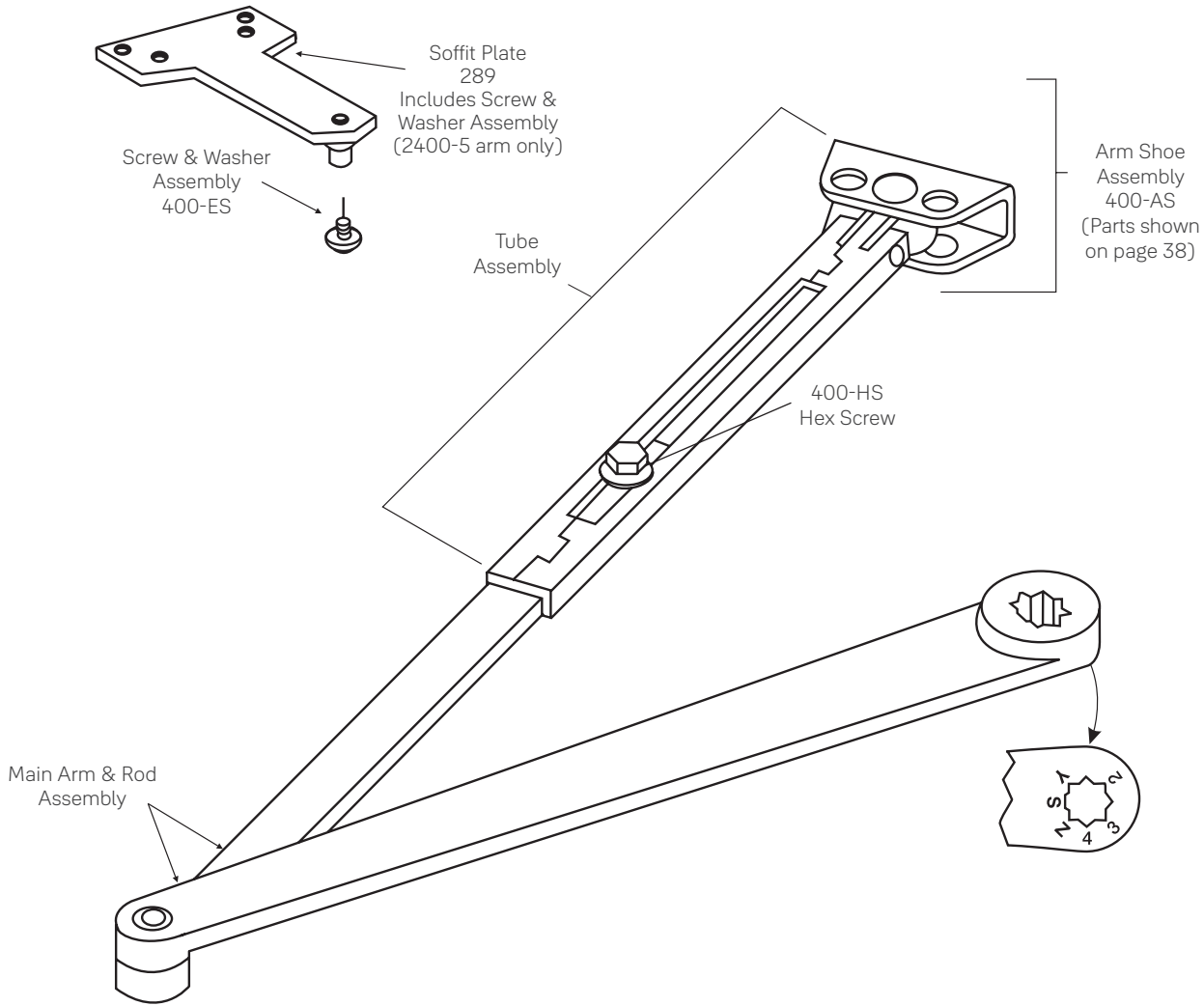

Arm Application	Complete Arm Assembly	Main Arm & Adjusting Rod Assembly	Tube & Shoe/Soffit Assembly
Regular Arm	2400-1	2400-1MR	2400-1TS (With 400-AS)
Parallel Arm	2400-5		2400-5TS (With 289)
Tri-pack	2400-25		

Note: Mounting hardware included with all parts orders.

Track Assemblies 4400ST & STP



Track Assemblies	Part Number	
	Non-Hold Open	Hold Open
Pull side mounted	400ST-1T	400ST-3T
Push side mounted	400ST-5T	400ST-8T
Pull side mounted (180°)	400ST-1T180	N/A

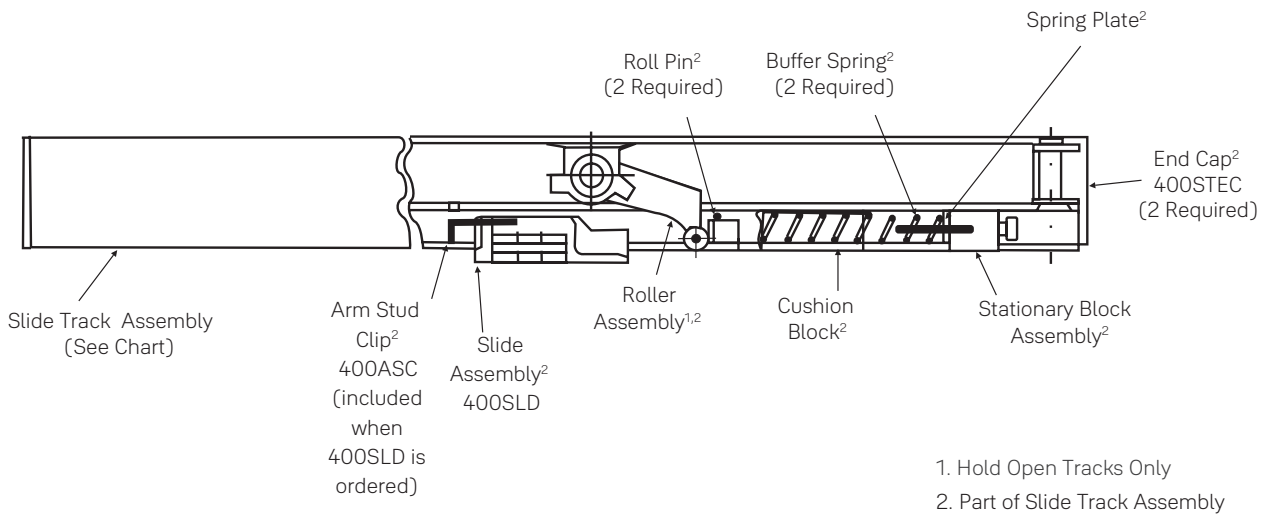

Note: Mounting hardware included with all parts orders.

Track Assemblies 4400ST & STP



Standard Arm Assembly

Arm tube assembly

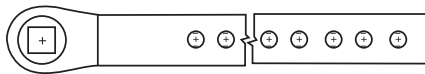

Arm Tube Assembly
400ST-1AT¹

400ST-1A^{1,2}

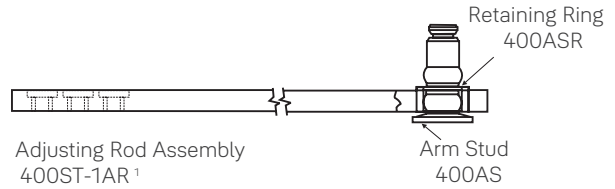

Adjusting Rod Assembly
400ST-1AR¹

Double Egress Arm Assembly

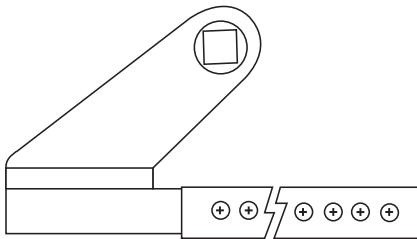

Arm Tube Assembly
400ST-1ATR¹ (right hand)
400ST-1ATL¹ (left hand)

400PT-DE-1R (Right Hand)^{1,2} 400PT-DE-1L (Left Hand)^{1,2}

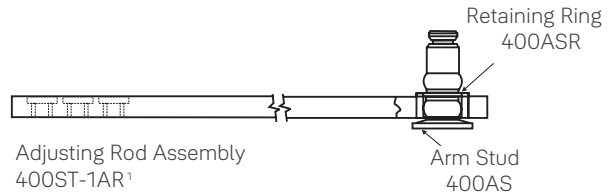

Adjusting Rod Assembly
400ST-1AR¹

Stp Arm Assembly

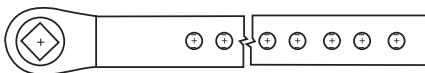

Arm Tube Assembly
400STP-1AT¹

400STP-1A^{1,2}

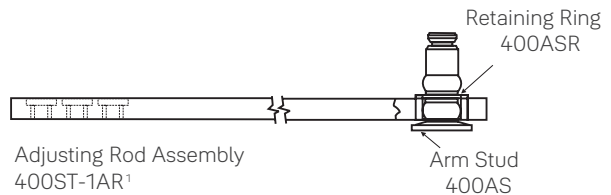

Adjusting Rod Assembly
400STP-1AR¹

1. Includes arm length adjusting screw #400-ALAS
2. Includes arm tube & adjusting rod assembly

Note: Mounting hardware included with all parts orders.



Track Assemblies 4400ST

Slide Track Assembly		
Description	Non-Hold Open	Hold Open
Pull side mounted	440ST-1T	440ST-3T
Push side mounted	440ST-5T	440ST-8T

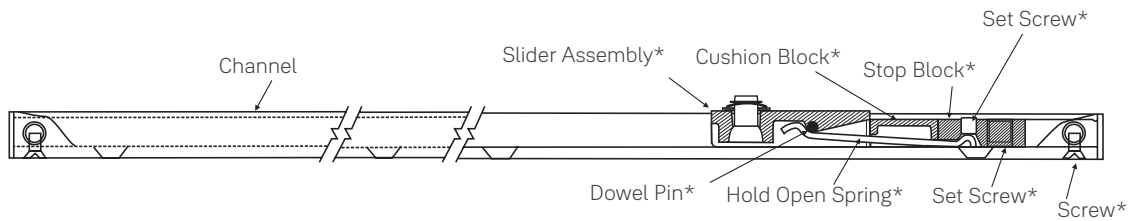

*Part of an Assembly Pack
 NHO= 440SLD
 HO= 440HSLD

Arm Assembly

440ST-1A^{1,2}

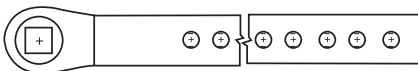

Arm Tube Assembly
 400ST-1AT²

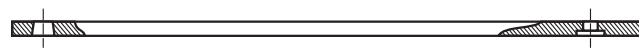

Adjusting Rod Assembly
 440ST-1AR²

1. Includes arm length adjusting screw
2. Includes arm tube & adjusting rod assembly

Note: Mounting hardware included with all parts orders.

Sample Specifications



4400 Series

Closers for interior and exterior doors shall be full rack-and-pinion type with cast aluminum alloy shell. Closers shall be surface mounted and shall project no more than 2-3/16" from the surface of the door. Closers shall be non-handed to permit installation on doors of either hand. Closer fluid shall contain lubricity and anti-oxidation agents. Closer fluid shall maintain stable viscosity to allow door closer to perform in temperatures ranging from extremely high to as low as -40°F. Closers shall have multi-size spring power adjustment to permit setting of spring from size 1 through 6. Closers shall have two non-critical valves, hex key adjusted, to independently regulate sweep and latch speed. Closers shall have backcheck cushioning controlled by a hex key adjusted valve. Closers shall have backcheck position controlled by a hex key adjusted valve.

[Closers shall have adjustable delayed-action closing controlled by a hex key adjustable valve.]

[Closers shall be highly corrosion resistant and shall have all external body components of aluminum, zinc alloy or stainless steel material and all fasteners of stainless steel.]

Regular arm and top jamb closers shall have a non-hold open shoe permitting 15% ($\pm 7-1/2\%$) power adjustment.**Closers shall be enclosed in a [molded resin cover], [plated or sprayed metal cover]. Closers to be Yale® [4400] [4400M] [4400S].

**For special arms insert the appropriate specification here (see below).

**UNI Stop™ Arm

Door closers shall have a fixed door stop feature effective at one point selected at installation, from 85-110° in five-degree increments. Door stop shall be cushioned by a shock-absorbing heavy-duty spring action effective at the [soffit plate] [arm shoe] pivot. [Closers shall be provided for parallel arm installation using rigid steel main arm and secondary arm lengths proportional to the door width.] [Closers shall be provided for top jamb installation using steel, rigid main arm and telescoping secondary arm adequate for the frame reveal of the openings.]

**Holder/Stop Arm

Door closers shall have a field reversible door stop. Hold open tension shall be adjustable effective at one point selected at installation, from 85° - 110° in five degree increments. Closers shall be provided for parallel arm installation using a forged rigid steel main arm and secondary arm.

**Holder/Stop Spring Arm

Door closers shall have built-in door stop [and holder] effective at one point selected at installation, from 85° - 110° in five-degree increments. Door stop mechanism shall be reversible and have a buffer spring that engages prior to the dead stop feature, reducing shock loads to the door and frame assembly. Door stop mechanism shall be attached to soffit plate. [Hold open mechanism shall have engage/disengage selection actuated by thumbturn]. Closers shall be provided for parallel installation using a forged rigid steel main arm and secondary arm.









Trusted every day

Customer Service Phone:

1-800-438-1951

Customer Service Fax:

1-800-338-0965

24/7 Support Phone:

1-855-213-5841

24/7 Support Email:

Support@YaleLock.com

Website:

yalecommercial.com

Email for orders:

orders.yaleus@assaabloy.com

Contact Us

U.S.A.

Yale Locks & Hardware

Address: 225 Episcopal Road

Berlin, CT 06037-4004

Tel: 1-800-438-1951

Fax: 1-800-338-0965

yalecommercial.com

Canada:

ASSA ABLOY Door Security Solutions Canada

Address: 160 Four Valley Drive

Vaughan, Ontario L4K 4T9

Tel: 1-800-461-3007

Fax: 1-800-461-8989

assaabloydss.ca

International:

ASSA ABLOY Americas International

Tel: 1-905-821-7775

Fax: 1-905-821-1429

assaabloyai.com

THE YALE BRAND, with its unparalleled global reach and range of products, reassures more people in more countries than any other consumer locking solution.

THE ASSA ABLOY GROUP is the world's leading manufacturer and supplier of locking solutions, dedicated to satisfying end-user needs for security, safety and convenience.

Yale Commercial is a business associated with ASSA ABLOY Access and Egress Hardware Group, Inc., an ASSA ABLOY Group company. Copyright © 2001-2021, ASSA ABLOY Access and Egress Hardware Group, Inc. All rights reserved. Reproduction in whole or in part without the express written permission of ASSA ABLOY Access and Egress Hardware Group, Inc. is prohibited. Patent pending and/or patent www.assaabloydss.com/patents.



3000 Series Architectural Door Closer

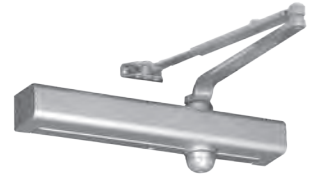



Contents

Introduction.....	2
Features & Benefits.....	3
Overview	4
Fasteners	5
Features.....	6
Optional Features.....	7
Finishes.....	8
How To Order.....	9
Applications	10-12
Technical Details	13-21
Accessories	22-33
Parts List	34-42
Suggested Specifications.....	43

3000 Series Door Closer

Yale 3000 Series Architectural Door Closers offer the perfect combination of reliability, aesthetics and durability in today's market. With features such as staked valves, self-drilling/self-tapping screws, rack and pinion design and precise valve adjustment, and a complete range of arm and cover options, the Yale 3000 Series can meet virtually any application challenge.

Offering sophisticated door control for any upscale commercial application, Yale Works for YouSM.

Features & Benefits

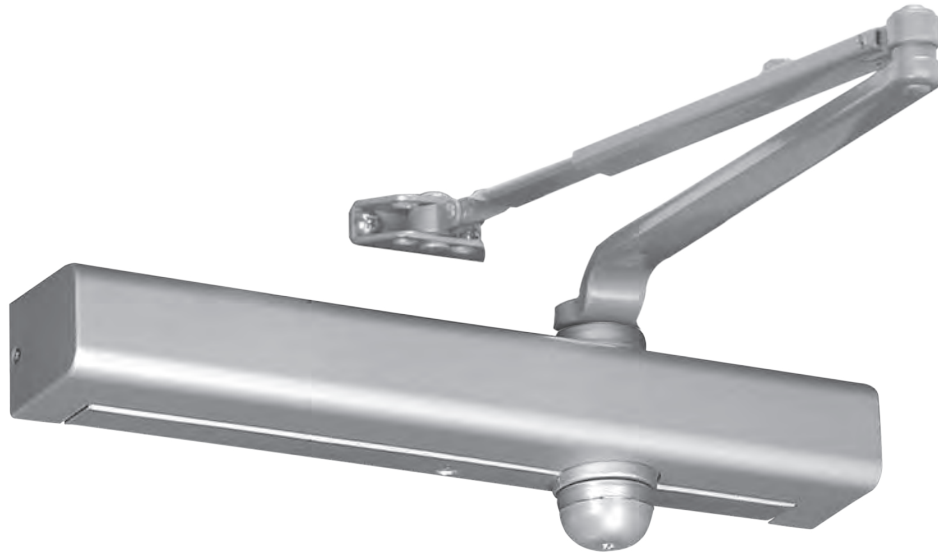

Features

- Exceeds 25 million cycles
- Cast aluminum body
- Adjustable spring sizes 1 through 6
- Tri-packed (regular arm, top jamb and parallel arm mounting)
- Non-handed
- Staked valves
- Rack & pinion design
- 1-1/4" (32mm) diameter piston
- 5/8" (16mm) diameter pinion journals
- Separate and independent, latch, sweep and backcheck intensity valves
- 2-1/8" (54mm) projection (standard covers)
- All standard arm applications (with slim, full or metal covers) allow doors to swing 180 degrees, conditions permitting

Benefits

- **Slim profile:** Seamless design blends into any building's aesthetic
- **Strong & durable:** ANSI/BHMA Grade 1 certified for long life and reliability

Optional Features

- Metal and architectural covers (3500 or 3501 only)
- Heavy-duty arms: Parallel Rigid, Holder/Stop, Holder/Stop Spring, UNI Stop™
- Delayed action
- Lead-lined metal cover (suffix MLL)

Overview



Cutaway View

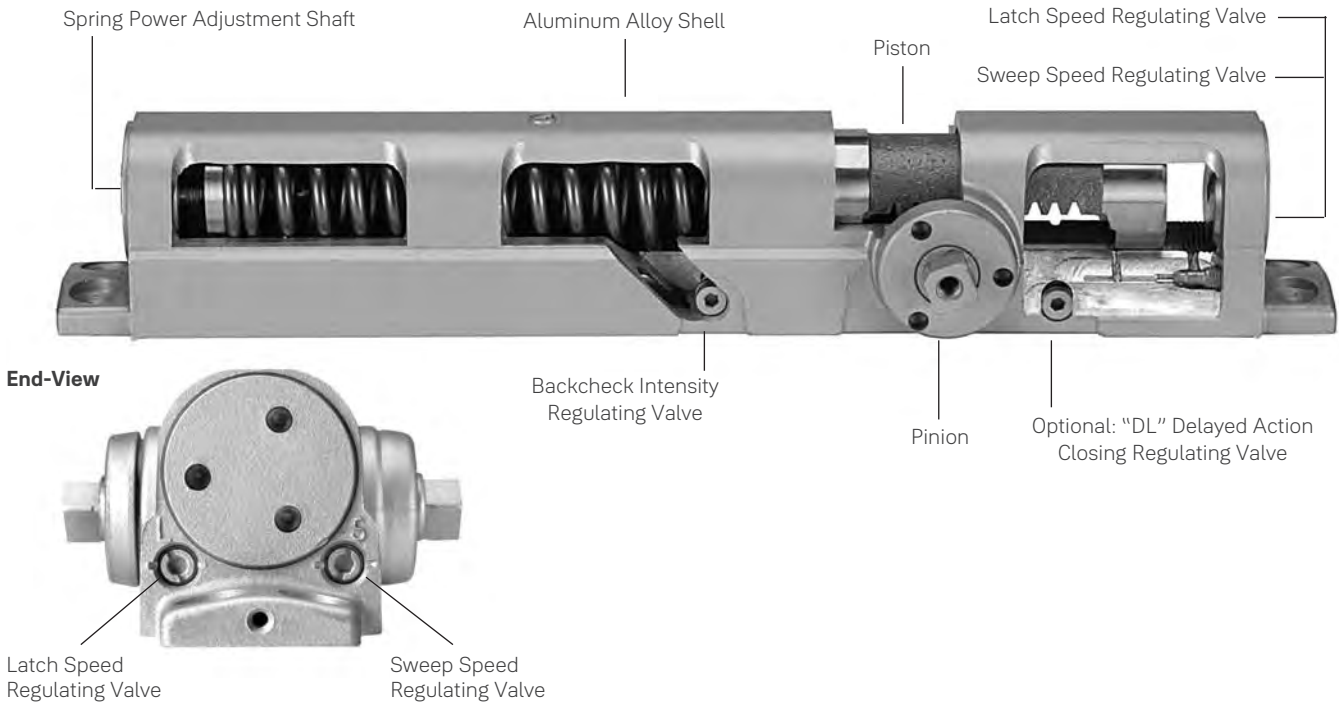

Compliance Standards

Series 3301 and 3501 door closers are designed to comply with requirements of the Americans with Disabilities Act (A.D.A.) and ANSI standard A117.1. All series 3301/3501 are ANSI/BHMA A156.4 Grade 1 certified. All Yale series 3301/3501 closers with non-hold open arms are listed by Underwriters Laboratories for labeled fire doors. This includes compliance to UL10C for 3-hour assemblies. The product is manufactured in an ISO 9001, ISO 14001 facility.

CAUTION: Door Closers for Low Opening Force Applications:

Door closers installed in openings required to meet the requirements of the Americans With Disabilities Act or ANSI/BHMA Standard A117.1, when adjusted to meet those requirements, may not provide adequate closing power to dependably close and latch the door based on opening or site conditions.

Fasteners



Type	Description	Arm							
		RA	PA	TJ	Low Profile	PR	Holder/Stop, Holder/Stop Spring	UNI	UNI-J
Door									
SDST	Self Drilling Self Tapping	S	S	S	S	S	S	S	S
MS	Machine Screw	S	S	S	S	S	S	S	S
SN	Sleeve Nut	0	0	0	0	S	S	S	S
TBGN	Through-Bolts & Grommet Nuts	0	0	0	0	0	0	0	0
SMS	Sheet Metal Screws	0	0	0	0	0	0	0	0
Torx*	Torx Drive Security Screw	0	0	0	0	0	0	0	0
Frame									
SDST	Self Drilling Self Tapping	S	S	S	S	S	S	S	S
MS	Machine Screw	S	S	S	S	S	S	S	S
SMS	Sheet Metal Screws	0	0	0	0	0	0	0	0
Torx	Torx Drive Security Screw	0	0	0	0	0	0	0	0

S = standard; 0 = optional

SN are for use on unreinforced hollow metal doors or to prevent any hollow metal door from collapse/dimpling. They can also be used for thru bolting on wood doors. SN are supplied for 1-3/4" (44mm) thick doors unless specified for 2-1/4" (57mm) thick doors.

TBGN are an alternative to SN for wood doors. TBGN are supplied standard for 1-3/4" (44mm) thick doors. They can be specified for 1-3/8" (35mm) thick doors.

SMS - when specified, closer will be packed with sheet metal screws for the door AND sheet metal screws plus machine screws for the frame.

TORX screws with security pin are standard with Security Door Closers. Torx may be specified for all other series applications. Torx are only available with machine screw threads. Sheet metal screw threads or wood screw threads are not available.

Note: To order special fasteners with closers, specify model number x fastener (Ex: 3501 x 689 x TBGN)

Features



Aluminum Alloy Housing

Closer bodies are constructed of a special aluminum alloy, carefully selected to accommodate interactive steel components and operating conditions.

Rack & Pinion Operation

Provides a smooth constant control of the door through its full opening and closing cycle. 180° door swing can be achieved when door, frame, hardware and arm function do not interfere.

Non-handed

With few exceptions all series and series 3301/3501 door closers are non-handed and can be installed on either right or left hand swing doors. Pinion shaft extends vertically through the closer body in both directions. Some options, as noted on page 5, will require that the hand of the closer be specified.

Sweep Speed Control Valve

Allows adjustment of door speed from the door's full open position down to approximately 10° from the closed position.

Latch Speed Control Valve

Allows adjustment of door speed from approximately 10° down to the door's fully closed position.

Closer Fluid

All door closers are supplied with a temperature stable, multi-viscosity fluid. This fluid will permit the door closer to perform within a wide temperature range: from very high to as low as -40°F.

Tri-Packed

3301/3501 come with screws, brackets and soffit plates to allow for regular, top jamb, and parallel arm installations.

Adjustable Backcheck Valve

Provides control of the door in the opening cycle, beginning at approximately 75° of door opening. It cushions the door opening when the door is forcibly opened beyond its pre-adjusted limits.

Standard Molded Covers

Molded of high-impact U.L. listed material. Standard covers are non-handed for all applications. See page 5 for optional covers.

Warranty

Limited 30-year warranty for defects and life of the building on the aluminum housing.

Door Closer Power Options

Series 3301/3501 Multi-Sized Door Closer

Adjustable through the power range of sizes 1 through 6, as outlined in ANSI/BHMA specification A156.4.

The series 3000 also conforms to the minimum opening force requirements of the Americans with Disabilities Act (A.D.A) and ANSI/BHMA standard A117.1 for interior doors.

Optional Covers

Optional Metal Cover

This steel cover is non-handed for regular and parallel arm applications, but is handed for top jamb applications. Cover is available in sprayed or plated finishes.



Optional Architectural Covers*

Plastic: Architectural plastic covers are molded of high impact U.L. listed material. They are non-handed and available in sprayed finishes.

Metal: The architectural metal covers are steel and non-handed for all applications. These covers are available in sprayed or plated finishes.

* For Parallel Arm Applications — Consult factory for doors swinging more than 120°

Optional ABS Cover

Consult factory for details.

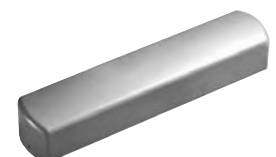



Optional Features

Delayed Action

Adjustable Delayed Action Closing

An optional hydraulic feature that adds a third speed range to the closing cycle. This feature becomes effective when the door is opened and released at any point beyond 70°. The amount of time delay depends upon the combination of the angle of door release and valve adjustment. The valve can be adjusted with a 1/8" (3mm) hex key from no delay time up to maximum delay times of:

Door Opened and Released at	Approximate Time of Delay Cycle
180°	4-5 minutes
120°	2-3 minutes
90°	25-30 seconds

Pressure Relief Safety Valve

The delayed action hydraulic system contains a pressure relief valve. Any time the door is forced toward the closed direction while it is in the closing cycle, the valve will open and permit the door to close. This prevents damage to door, frame and closer.

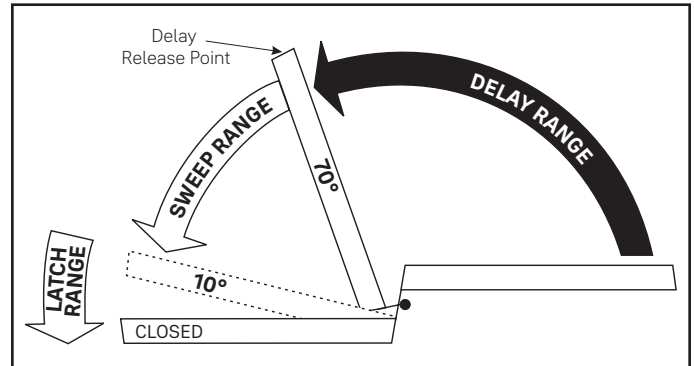

Suggested Applications

Delayed Action closing allows slow-moving traffic to clear the opening before the door closer's normal closing cycle begins. This feature can be helpful in health care facilities such as hospitals and nursing homes. It provides sufficient time for persons on crutches or in wheelchairs to pass through a door without concern of it closing. At the same time, it can accommodate the facility's staff with movement of food service carts, beds, and other wheeled traffic.

Use of delayed action closers on many doors throughout industrial and commercial buildings can also assist the flow of traffic. Locations where additional time to clear the opening is advantageous are doors between office and factory/warehouse facilities, doors to workshops or laboratories, kitchens and food processing areas.

Arms

Non-Hold Open

Self-closes door every time door is opened. Auxiliary stop (by others) required except when using the Holder/Stop, Holder/Stop Spring or UNI Stop™ arms.

Hold Open

Achieved by means of friction or ball and detent/roller. Friction hold open has a range of 90° to 180° using template location and mechanical adjustment. Ball and detent or roller hold open is effective in a range of 85° to 110°.

Hold open arm door closers are not permitted to be used on fire door assemblies.

Door Opening Degrees











Arm Function	Regular Arm, Top Jamb, Parallel Arm	Parallel Rigid Arm	Holder/Stop Parallel Arm	Holder/Stop Spring Parallel Arm	UNI Stop™ Parallel Arm	UNI Stop™ Top Jamb	Low Profile
Non-Hold Open	✓	✓	85° to 110°	85° to 110°	85° to 110°	85° to 110°	✓
Hold Open	90° to 180°	85° to 180°	85° to 110°	85° to 110°	85° to 110°	85° to 110°	N/A

✓=180° trim and template permitting

Finishes



Product will be painted with a combination of waterborne acrylic and polyester powder coat. Closers will withstand 100 hours of salt spray. (The ANSI requirement is 25 hours.)

ANSI/BHMA Code Finish Description			
600* Primed for Painting	605 Bright Brass, Clear Coated	606 Satin Brass, Clear Coated	611 Bright Bronze, Clear Coated
			
612 Satin Bronze, Clear Coated	613E Dark Oxidized Satin Bronze - equivalent	625 Bright Chrome Plated	626 Satin Chrome Plated
			
689 Aluminum Painted	690 Dark Bronze Painted	691 Light Bronze Painted	693 Black Painted
			
694 Medium Bronze Painted	696 Satin Brass Painted	BSP Black Suede Powder Coat	WSP White Suede Powder Coat

*600 is a special rust-inhibiting prime coat. Closers can be ordered prime coat only (specify closer x 600). An additional charge applies if finish coat is required over prime coat (ex: 3501 x 600 x 689).

Plated Finishes	Specify Designation (ANSI/BHMA)	Metal Covers Only
Bright Brass	605	Yes
Satin Brass	606	Yes
Bright Bronze	611	Yes
Satin Bronze	612	Yes
Bright Chrome	625	Yes
Satin Chrome	626	Yes

When a plated finish is ordered, arm and metal cover will be plated unless "cover only" is specified. 3101, 3301 - available with plated arm only.



How To Order

For optimum protection of door and frame assemblies, always use auxiliary wall, floor or overhead door stop.

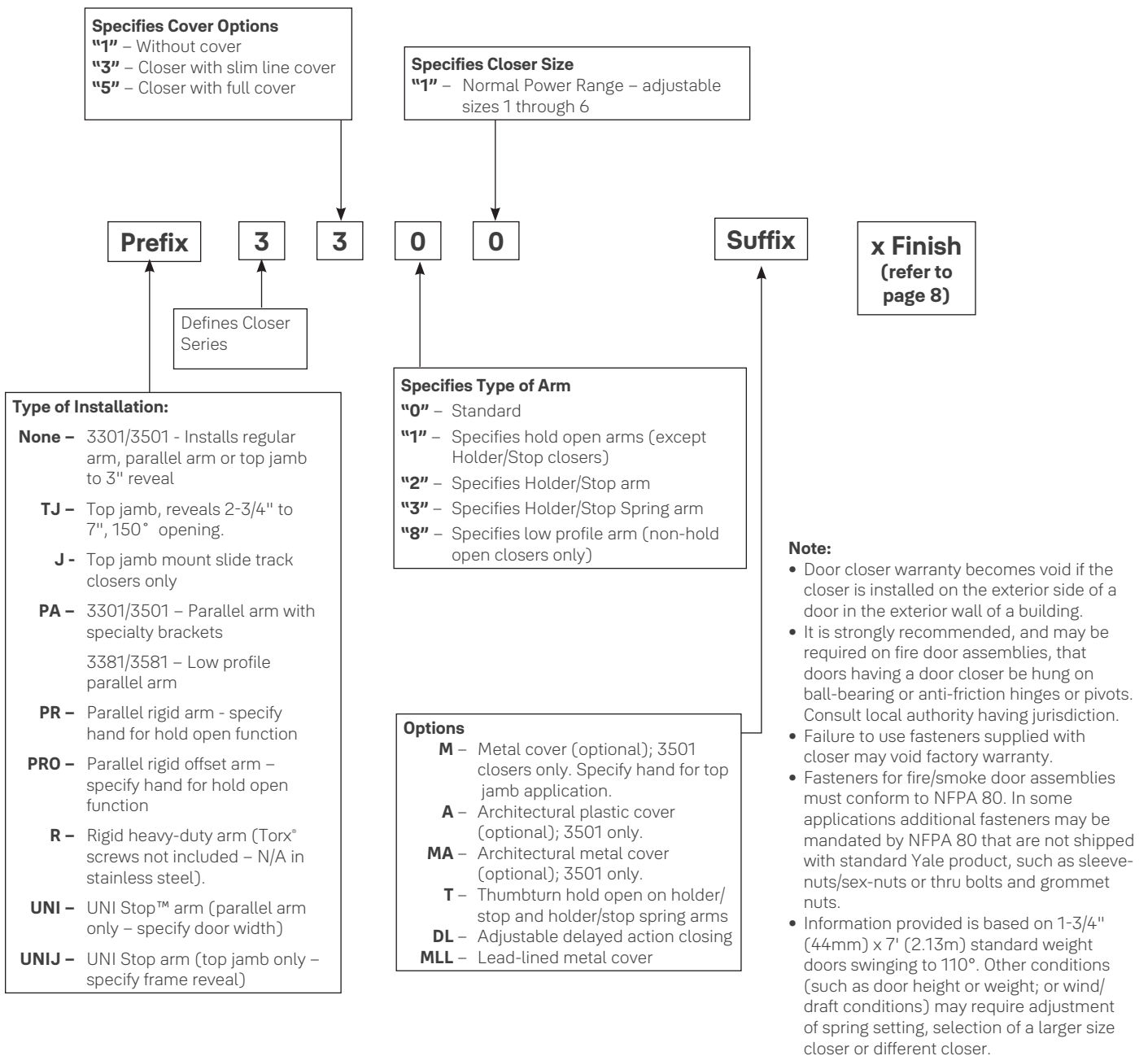



Regular Arm

3301

This is the only pull side application where a double lever arm is used. It is the most power-efficient application for a door closer. Sufficient frame, door and/or ceiling clearance must be considered.



3501

Since the arm assembly projects directly out from the frame, this application may present an aesthetics issue or be prone to vandalism.



Top Jamb

3301

For efficiency reasons this application provides the best alternative to the regular arm application. There must be sufficient frame face and/or ceiling clearance for this application. It requires a top rail on the door of just 2-1/4" (57mm). This application provides the best door control for doors in exterior walls that swing out of a building.



3501

The entire door closer and arm assembly project from the frame, similar to the regular arm application, where matters of appearance and malicious abuse can be of concern. Consideration must be given to depth of reveal.

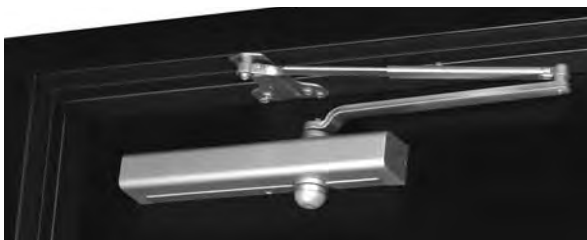

Parallel Arm

3301

This application provides the most appealing design appearance for a surface-mounted door closer having a double lever arm. This also makes it beneficial in vandalism-prone areas. It is on the push side of the door and the arm assembly extends almost parallel to the door. In the closed position, there is very little or no hardware projecting beyond the frame face in most situations.



3501

Due to the geometry of the arm it is approximately 25% less power-efficient than a regular arm application. The entire closer and arm assembly are mounted below the frame stop. Top rail clearance dimensions will vary based on the type of cover used. (See page 13.)



Parallel Rigid Arm

An enhanced variation of the standard parallel arm assembly that is intended for use in heavy traffic areas where auxiliary door stops are installed. Hold open available — specify hand when ordering.



Holder/Stop Arm

Similar to the Parallel Rigid arm, this arm incorporates a stop at the arm's soffit plate to dead stop the door at a predetermined degree of door swing between 85° and 110°, in 5° increments. Prior to dead stop the door closer's backcheck feature slows the door speed to reduce the impact of the stop action.

The Holder/Stop arm is intended for use where an auxiliary door stop cannot be utilized and no more than moderate abuse is anticipated. Where more extreme conditions are expected, use of a UNI Stop™ arm is recommended. Available with or without hold open. (Hold open strength is adjustable.)



Holder/Stop Spring Arm

This arm has all the characteristics of the Holder/Stop arm with an additional steel buffer spring that provides greater protection at the end of the door opening cycle. For extreme conditions, use of a UNI Stop arm is recommended. Available with or without hold open.



Regular Rigid Heavy-Duty Arm

This double lever arm features a non-adjustable secondary arm. Orbitally riveted joints prevent tampering or disassembly. Prefix "R" to model number. Available non-hold open only.



Parallel

UNI Stop™ Arm

Can be used for either parallel arm or top jamb applications. UNI Stop arms combine the features of a double lever arm overhead door stop/holder with the backcheck feature of the door closer to reduce door stopping shock loads to a minimum. This arm uses a compression spring buffer at the soffit plate/arm shoe that absorbs 30 lbf. of force, 5° prior to the door's dead stop. The UNI Stop arm, coupled with the door closer's



Top Jamb

backcheck feature, provides the most controlled stop available with a surface door closer.

For parallel arm applications there are three different length arm assemblies. Each length is designed for a specific range of door widths, to provide precise door control. This further lessens the dead stop impact on the door's hinges/pivots.

Only available in painted finishes.



Regular Arm

Allows closer to be installed where there is as little as 1" (25mm) of frame face ceiling clearance



Parallel Arm

Allows closer to be installed 1/2" (13mm) higher up on door than standard parallel arm application.

Low Profile Arm

Supplied with 3381/3581 series door closers for non-hold open installations only. Low profile arms have a reduced height elbow joint and a straight main arm. This enables the door closer to be installed in less vertical space.

Note: Low profile arm door closers are not supplied tri-packed.

Regular Arm

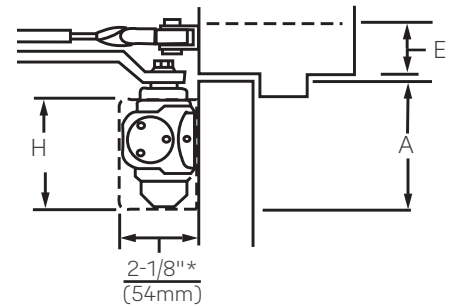
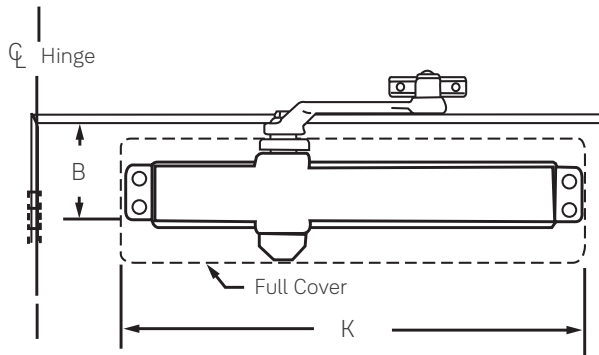

Mounting holes for closer body are spaced $\frac{3}{4}$ " (19mm) vertically x 12" (305mm) horizontally.
 Note: All measurements are Inches/mm.
 Maximum 180° door swing, conditions permitting

Closer Series	Covers	E Minimum Ceiling Clearance			B Minimum Top Rail				A Minimum Top Rail Clearance		K Closer Length	H Closer Height
					W/O Drop Plate		W/3146 Drop Plate					
		NHO	Low Profile	HO	NHO/HO	Low Profile	NHO/HO	Low Profile	NHO/HO	Low Profile		
3100	No Cover										$\frac{12-3}{4}$ " (324)	
3300	Slim Line Plastic								$\frac{3-1}{2}$ " (89)	$\frac{3-3}{8}$ " (86)	$\frac{13}{1}$ " (330)	$\frac{2-7}{8}$ " (73)
3500	Full Plastic	$\frac{1-1}{2}$ " (38)	1" (25)	$\frac{1-5}{8}$ " (41)	$\frac{2-1}{2}$ " (64)	$\frac{2-3}{8}$ " (60)	$\frac{1-5}{8}$ " (41)	$\frac{1-1}{2}$ " (38)				
3500M	Metal								$\frac{4-1}{4}$ " (108)	$\frac{4-1}{8}$ " (105)	$\frac{13-5}{8}$ " (346)	$\frac{3-3}{4}$ " (95)
3500A	Arch. Plastic								$\frac{3-5}{8}$ " (92)	$\frac{3-1}{2}$ " (89)	14" (356)	$\frac{3-1}{8}$ " (79)
3500MA	Arch. Metal								$\frac{3-1}{2}$ " (89)	$\frac{3-3}{8}$ " (86)		3" (76)

Model Numbers	
Non-Hold Open	Hold Open
3301 3501	3311 3511

Note:
 * Projection is for Slim Line or Full Covers. Projection for Metal Covers = $\frac{2-3}{16}$ " (56mm). Projection for Architectural Plastic & Architectural Metal Covers = $\frac{2-1}{4}$ " (57mm).
 Standard door widths 30"-48" (76 - 122cm)

Consult factory if door weight exceeds 250 lbs.



Top Jamb Arm

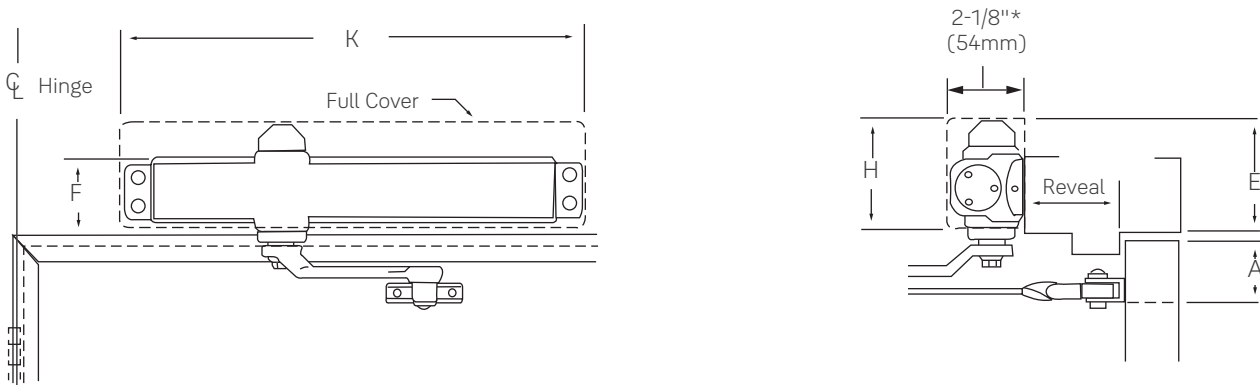

Mounting holes for closer body are spaced 3/4" (19mm) vertically x 12" (305mm) horizontally.
 Note: All measurements are Inches/mm.

Closer Series	Covers	F Minimum Frame Face		E Minimum Ceiling Clearance			A Minimum Top Rail Clearance									K Closer Length	H Closer Height	
		W/O Drop Plate	With 3146 Drop Plate	With 3148, 3158, 3547 & 3547A Drop Plates	W/O Drop Plate	With 3146 Drop Plate	With 3148, 3158, 3547 & 3547A Drop Plates	W/O Drop Plate			W/3146 Drop Plate			With 3148/3547 Drop Plate				
								NHO	Low Profile	HO	NHO	Low Profile	HO	NHO	Low Profile			HO
3100	No Cover																12-3/4" (324)	
3300	Slim Line Plastic		1-1/8" (29)	1-1/2" (38)	2-3/4" (70)	1-5/8" (41)	1-1/2" (38)										13" (330)	2-7/8" (73)
3500	Full Plastic																	
3500M	Metal	1-3/4" (44)		1-5/8" (41)	3-3/4" (95)		1-5/8" (41)	2-1/4" (57)	N/A	2-1/2" (64)	3-3/8" (86)	2-3/4" (70)	3-5/8" (92)	4-3/8" (111)	3-3/4" (95)	4-5/8" (117)	13-5/8" (346)	3-3/4" (95)
3500A	Arch. Plastic		N/A	1-1/2" (38)	3" (76)	N/A	1-1/2" (38)										14" (356)	3-1/8" (79)
3500MA	Arch. Metal				2-7/8" (73)													3" (76)

Note: Reveal range information is based upon 1-3/4" (44mm) doors hung on 4-1/2" wide hinges.

* Projection is for Slim Line or Full Covers. Projection for Metal Covers = 2-3/16" (56mm). Projection for Architectural Plastic & Architectural Metal Covers = 2-1/4" (57mm).

Consult factory if door weight exceeds 250 lbs.

Technical Details



Top Jamb Arm

Model Number	
Non-Hold Open	Hold Open
3301	3311
3501	3511

Note: Standard door widths 30" - 48" (76-122cm)

Reveal Information		
Reveal Range Inches (mm)	Maximum Door Opening	
	NHO	Hold Open
2-3/4" (70) to 4-1/4" (108)	180°	—
4-1/4" (108) to 7" (178)	150°	—
2-1/8" (54) to 4-1/4" (108)	—	180°
4-1/4" (108) to 6-3/4" (171)	—	150°

Reveal Information (regular arm installed top jamb)		
Reveal Range Inches (mm)	Maximum Door Opening	
	NHO	Hold Open
0 to 2-7/8" (73)	180°	—
0 to 2-3/4" (70)	180°	—
0 to 2-3/4" (70)	—	180°

** Drop Plate 3146, 3148, 3158, 3547 or 3547A

Note: Reveal range information is based upon 1-3/4" (44mm) doors hung on 4-1/2" wide hinges.



Parallel Arm

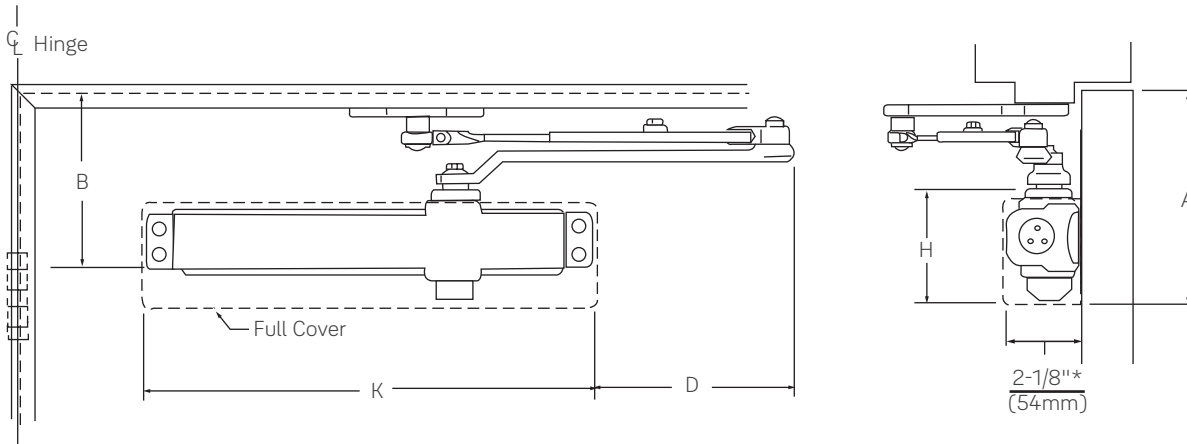

Mounting holes for closer body are spaced 3/4" (19mm) vertically x 12" (305mm) horizontally.
 Note: All measurements are Inches/mm.
 Maximum 180° door swing, conditions permitting.

Closer Series	Covers	B Minimum Top Rail 5/8" (16mm) Frame Stop						A Top Rail Clearance			K Closer Length	H Closer Height	D Arm Extension
		W/O Drop Plate			With 3148/3548 Drop Plate			NHO	Low Profile	HO			
		NHO	Low Profile	HO	NHO	Low Profile	HO						
3100	No Cover										12-3/4" (324)		8-1/8" (206)
3300	Slim Line Plastic							6-1/4" (159)	5-5/8" (143)	6-1/4" (159)	13" (330)	2-7/8" (73)	8" (203)
3500	Full Plastic	5-1/4" (133)	4-5/8" (117)	5-1/4" (133)	3" (76)	2-3/8" (60)	3" (76)						
3500M	Metal							6-7/8" (175)	6-1/4" (159)	6-7/8" (175)	13-5/8" (346)	3-3/4" (95)	
3500A	Arch. Plastic							6" (152)	5-3/8" (137)	6" (152)	14" (356)	3-1/8" (79)	7-5/8" (194)
3500MA	Arch. Metal							5-7/8" (149)	5-1/4" (133)	5-7/8" (149)		3" (76)	

Model Number	
Non-Hold Open	Hold Open
3301 3501	3311 3511

Note:
 * Projection is for Slim Line or Full Covers. Projection for Metal Covers = 2-3/16" (56mm). Projection for Architectural Plastic & Architectural Metal Covers = 2-1/4" (57mm).
 Standard door widths 30" - 48" (76-122cm)

Consult factory if door weight exceeds 250 lbs.

Parallel Rigid Arm

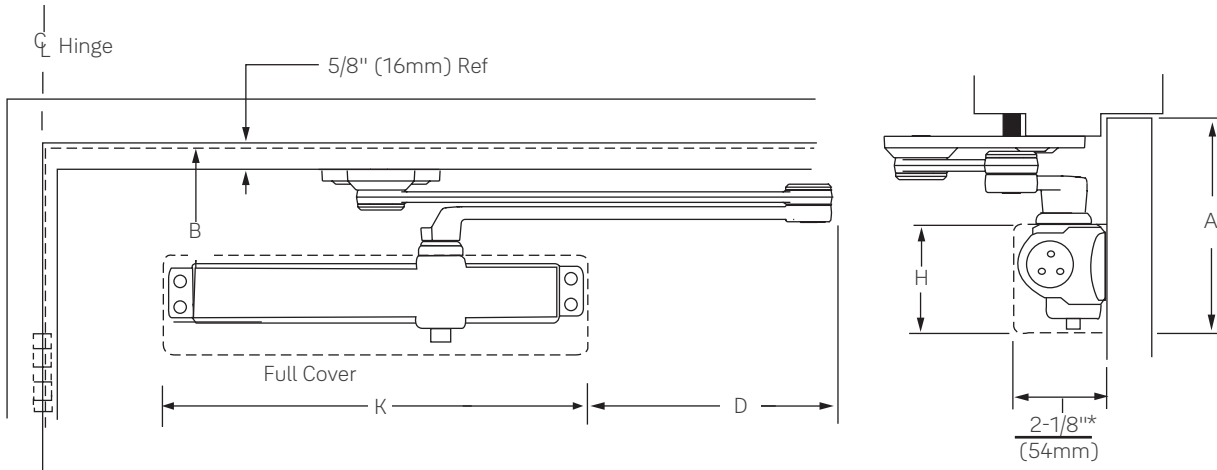

Mounting holes for closer body are spaced 3/4" (19mm) vertically x 12" (305mm) horizontally.
 Note: All measurements are Inches/mm.

Closer Series	Covers	B Minimum Top Rail		A Minimum Top Rail Clearance	K Closer Length	H Closer Height	D Arm Extensions
		W/O Drop Plate	With Drop Plate				
3100	No Cover	4-5/8" (117)	2-3/8" (60)	5-7/8" (149)	12-3/4" (324)	2-7/8" (73)	8" (203)
3300	Slim Line Plastic				13" (330)		
3500	Full Plastic						
3500M	Metal			6-1/2" (165)	13-5/8" (346)	3-7/8" (98)	7-5/8" (194)
3500A	Arch. Plastic			6" (152)	14" (356)	3-1/8" (79)	7-1/2" (191)
3500MA	Arch. Metal			5-7/8" (149)	3" (76)		

Model Number	
Stop Only	Hold Open
PR3301 PR3501	PR3311 PR3511

Note:

* Projection is for Slim Line or Full Covers. Projection for Metal Covers = 2-3/16" (56mm). Projection for Architectural Plastic & Architectural Metal Covers = 2-1/4" (57mm).
 Standard door widths 28" - 42" (71-122cm)

Consult factory if door weight exceeds 250 lbs.



Holder/Stop Arm

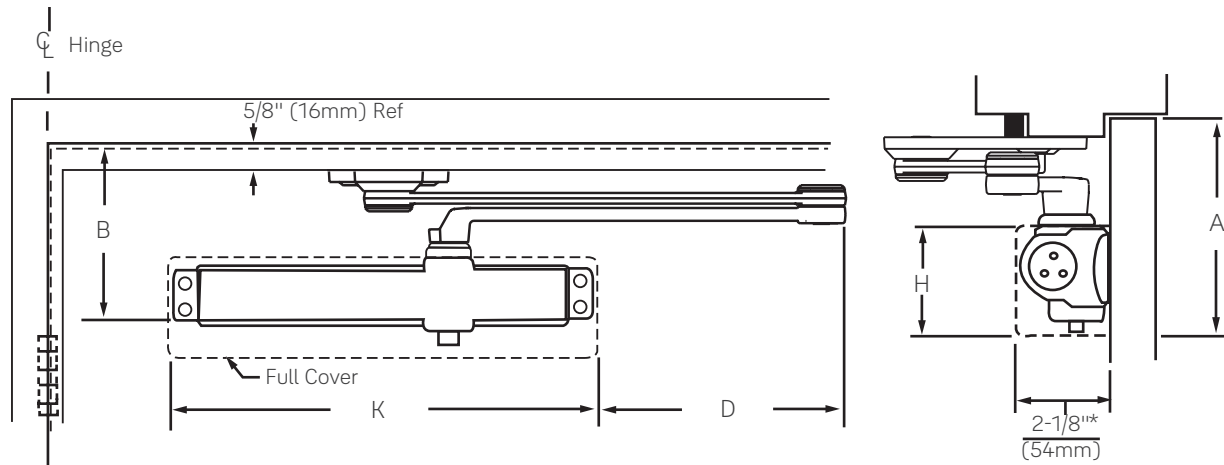

Mounting holes for closer body are spaced 3/4" (19mm) vertically x 12" (305mm) horizontally.
 Note: All measurements are Inches/mm.

Closer Series	Covers	B Minimum Top Rail		A Minimum Top Rail Clearance	K Closer Length	H Closer Height	D Arm Extensions
		W/O Drop Plate	With Drop Plate				
3100	No Cover	4-5/8" (117)	2-3/8" (60)	5-7/8" (149)	12-3/4" (324)	2-7/8" (73)	8" (203)
3300	Slim Line Plastic				13" (330)		
3500	Full Plastic			6-1/2" (165)	13-5/8" (346)	3-7/8" (98)	7-5/8" (194)
3500M	Metal			6" (152)	14" (356)	3-1/8" (79)	7-1/2" (191)
3500A	Arch. Plastic			5-7/8" (149)	3" (76)		
3500MA	Arch. Metal						

Model Number	
Stop Only	Hold Open
3321	3321T
3521	3521T

Note:

* Projection is for Slim Line or Full Covers. Projection for Metal Covers = 2-3/16" (56mm). Projection for Architectural Plastic & Architectural Metal Covers = 2-1/4" (57mm).

Standard door widths 28" - 42" (71-122cm)

Consult factory if door weight exceeds 250 lbs.



Holder/Stop Spring Arms

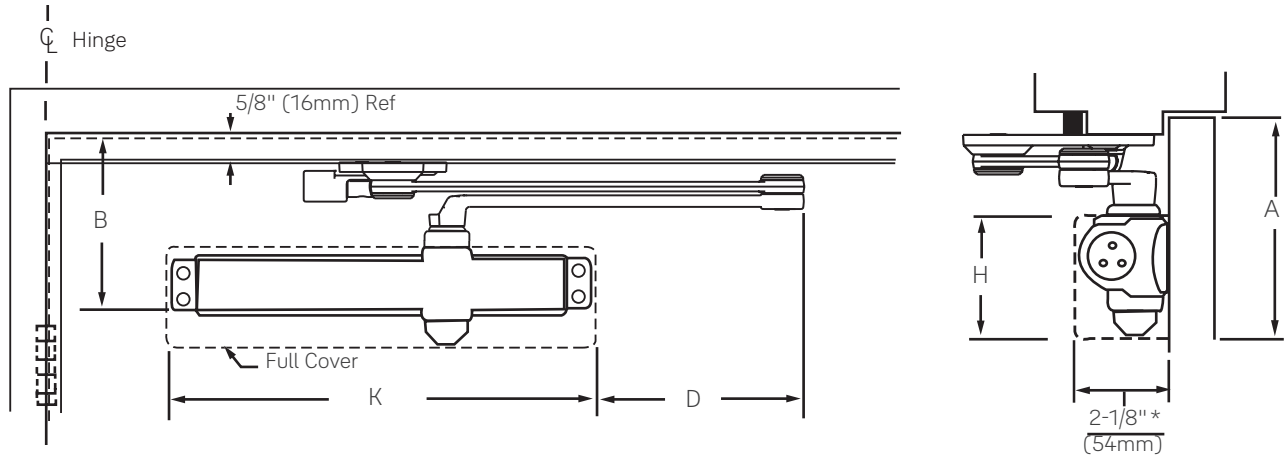

Mounting holes for closer body are spaced 3/4" (19mm) vertically x 12" (305mm) horizontally.
 Note: All measurements are Inches/mm.

Closer Series	Covers	B Minimum Top Rail		A Minimum Top Rail Clearance	K Closer Length	H Closer Height	D Arm Extensions
		W/O Drop Plate	With Drop Plate				
3100	No Cover	4-5/8" (117)	2-3/8" (60)	5-7/8" (149)	12-3/4" (324)	2-7/8" (73)	8" (203)
3300	Slim Line Plastic				13" (330)		
3500	Full Plastic			6-1/2" (165)	13-5/8" (346)	3-7/8" (98)	
3500M	Metal			6" (152)	14" (356)	3-1/8" (79)	
3500A	Arch. Plastic			5-7/8" (149)		3" (76)	
3500MA	Arch. Metal						

Model Number	
Stop Only	Hold Open
3331	3331T
3531	3531T

Note:
 * Projection is for Slim Line or Full Covers. Projection for Metal Covers = 2-3/16" (56mm). Projection for Architectural Plastic & Architectural Metal Covers = 2-1/4" (57mm).
 Standard door widths 28" - 42" (71-122cm)

Consult factory if door weight exceeds 250 lbs.



UNI Stop™ - Parallel Arm

Mounting holes for closer body are spaced 3/4" (19mm) vertically x 12" (305mm) horizontally.

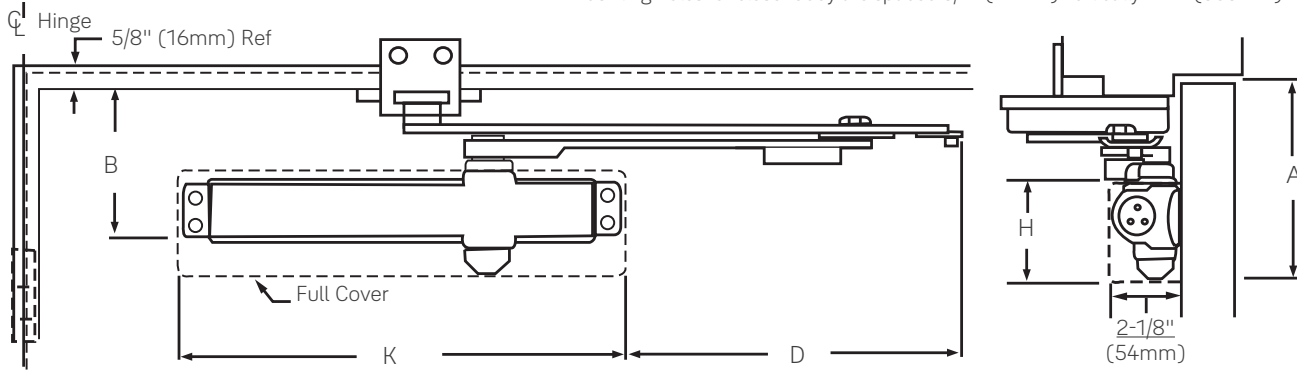

Closer Series	Door Width	Covers	B Minimum Top Rail		A Minimum Top Rail Clearance	K Closer Length	H Closer Height	D Arm Extensions											
			W/O Drop Plate	With Drop Plate															
3300	28-32	Slim Line Plastic	4-3/4" (121)	2-1/2" (64)	5-3/4" (146)	13" (330)	2-7/8" (73)	8-3/8" (213)											
	33-41							9-7/8" (251)											
	42-48							11-1/4" (286)											
3500	28-32	Full Plastic			4-3/4" (121)	2-1/2" (64)	5-3/4" (146)	13" (330)	2-7/8" (73)	8-3/8" (213)									
3500M		Metal								6-3/8" (162)	13-5/8" (346)	3-7/8" (98)	8" (203)						
3500A		Arch. Plastic								5-1/2" (140)	14" (356)	3-1/8" (79)	7-7/8" (200)						
3500MA		Arch. Metal								5-3/8" (137)	3" (76)	7-1/2" (191)							
3500		33-41								Full Plastic	4-3/4" (121)	2-1/2" (64)	5-3/4" (146)	13" (330)	2-7/8" (73)	9-7/8" (251)			
3500M										Metal						6-3/8" (162)	13-5/8" (346)	3-7/8" (98)	9-1/2" (241)
3500A										Arch. Plastic						5-1/2" (140)	14" (356)	3-1/8" (79)	9-3/8" (238)
3500MA										Arch. Metal						5-3/8" (137)	3" (76)	9" (229)	
3500		42-48								Full Plastic	4-3/4" (121)	2-1/2" (64)	5-3/4" (146)	13" (330)	2-7/8" (73)	11-1/4" (286)			
3500M										Metal						6-3/8" (162)	13-5/8" (346)	3-7/8" (98)	10-7/8" (276)
3500A										Arch. Plastic						5-1/2" (140)	14" (356)	3-1/8" (79)	10-3/4" (273)
3500MA										Arch. Metal						5-3/8" (137)	3" (76)	10-3/8" (264)	

Model Number		x Specify Door Width
Stop Only	Hold Open	
UNI3301 UNI3501	UNI3311 UNI3511	

Standard door widths 28" - 42" (71-122cm)

Consult factory if door weight exceeds 250 lbs.



UNI Stop™ - Top Jamb Arm

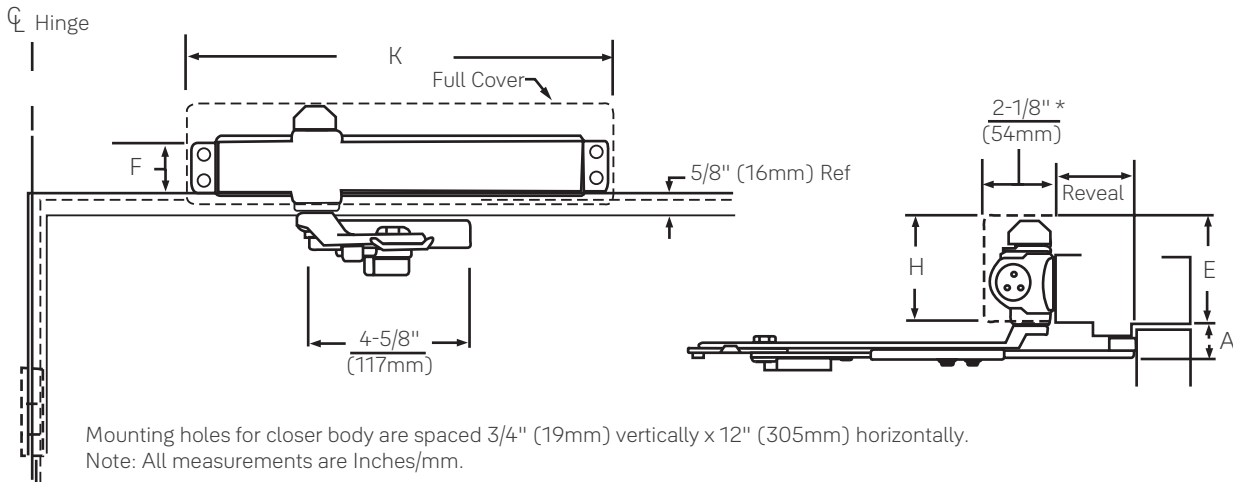

Closer Series	Covers	F Minimum Frame Face		E Minimum Ceiling Clearance		A Minimum Top Rail Clearance		K Closer Length	H Closer Height
		W/O Drop Plate	With 3148, 3158, 3547 & 3547A Drop Plates	W/O Drop Plate	With Drop Plate	W/O Drop Plate	With 3148, 3158, 3547 & 3547A Drop Plates		
3300	Slim Line Plastic	1-3/4" (44)	1-1/2" (38)	2-3/4" (70)	1-1/2" (38)	1-7/8" (48)	3-3/4" (95)	13" (330)	2-7/8" (73)
3500	Full Plastic		1-5/8" (41)	3-3/4" (95)	1-5/8" (41)			13-5/8" (346)	3-7/8" (98)
3500M	Metal		1-1/2" (38)	3" (76)	1-1/2" (38)			14" (356)	3-1/8" (79)
3500A	Arch. Plastic		2-7/8" (73)						
3500MA	Arch. Metal								

Model Number		x Specify Frame Reveal
Stop Only	Hold Open	
UNIJ3301 UNIJ3501	UNIJ3311 UNIJ3511	

Note:
 * Projection is for Slim Line or Full Covers. Projection for Metal Covers = 2-3/16" (56mm). Projection for Architectural Plastic & Architectural Metal Covers = 2-1/4" (57mm).
 Standard door widths 28" - 42" (71-122cm)

Consult factory if door weight exceeds 250 lbs.



Regular Arm

Closer Mounting Plates Slim Line Installations

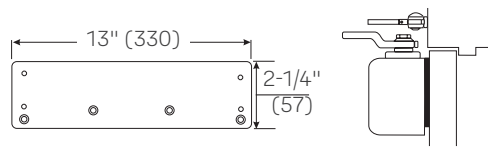
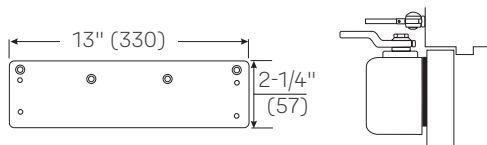

Narrow Top Rail - 3146 Drop Plate: For use where the narrow top rail of the door prevents the closer from being mounted directly on to the door surface. This drop plate must be used for any Series 3000 closer mounted on a top rail between 1-9/16" and 2-7/16" (40 and 62mm) in height, or any 3000 low profile closer mounted on a top rail between 1-7/16" and 2-5/16" (36 and 59mm) in height.

Concealed Door Holder - 3146 Drop Plate: For use where a concealed door holder prevents normal mounting of the closer to the door. This is the same plate used for narrow rail mounting, but is inverted for this application to permit the mounting screws to clear the bottom of the door-holder preparation in the top rail of the door. This places the centerline of the plate's upper mounting screws at 2-3/16" (56mm) from the top of the door.

Full Cover Installations

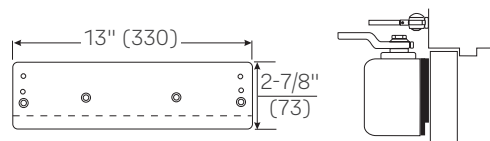
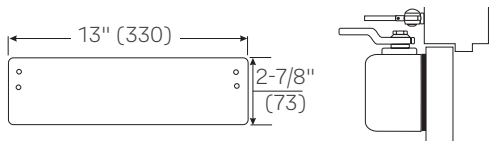

Exposed Back - 3445 Molded Full Cover Decorative Back Plate: For use on doors with glass lights where a closer with a molded full cover is installed and the closer back is exposed. This plate covers the back of the installation to give a pleasing appearance from the reverse side.

Exposed Back/Narrow Top Rail - Exposed Back Concealed Door Holder - 3446 Molded Full Cover Drop Plate Kit: For use with molded full cover installation when a 3146 Plate is needed as a drop plate on a narrow top rail, or as a clearance plate for a concealed door holder, and the closer back is exposed. Kit contains a 3146 Drop Plate and a 3445 Decorative Plate.

Metal Cover Installations

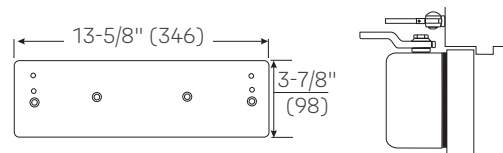
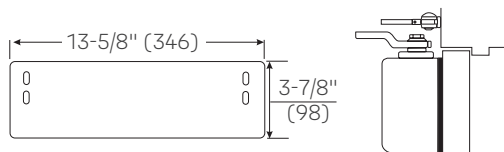

Exposed Back - 3545 Metal Cover Decorative Back Plate: For use on doors with glass lights where a closer with a metal full cover is installed and the closer back is exposed. This plate covers the back of the installation to give a pleasing appearance from the reverse side.

Concealed Door Holder - 3546 Metal Cover Drop Plate: For use where a concealed door holder prevents the normal mounting of the closer to the door. This plate permits the mounting screws to clear the bottom of the door-holder preparation in the top rail of the door. This places the centerline of the plate's upper mounting screws at 2-3/16" (56mm) from the top of the door.

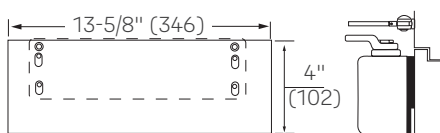

Exposed Back/Narrow Top Rail - 3549 Metal Cover Drop Plate Kit: For use with metal full cover installations, when a 3146 Plate is needed as a drop plate on a narrow top rail and the closer back is exposed. Kit contains a 3146 Drop Plate and a 3545 Decorative Plate.

Note: All measurements are Inches/mm.

Regular Arm

CLOSER MOUNTING PLATES ARCHITECTURAL PLASTIC OR METAL COVER INSTALLATIONS

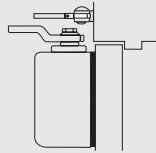
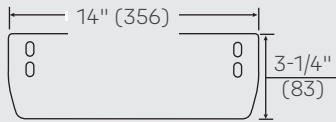

Exposed Back - 3545A Architectural Plastic or Architectural Metal Cover Decorative Back Plate: For use on doors with glass lights where a closer with an architectural plastic or metal cover is installed and the closer back is exposed. This plate covers the back of the installation to give a pleasing appearance from the reverse side.

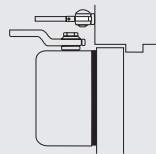
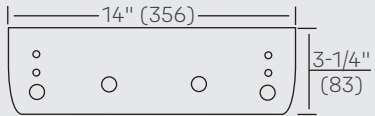

Concealed Door Holder - 3546A Architectural Plastic or Architectural Metal Cover Drop Plate: For use where a concealed door holder prevents the normal mounting of the closer to the door. This plate permits the mounting screws to clear the bottom of door-holder preparation in the top rail of the door. This places the centerline of the plate's upper mounting screws at 2-3/16" (56mm) from the top of the door.

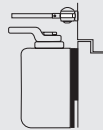
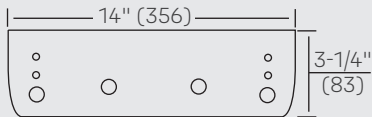

Exposed Back/Narrow Top Rail - 3549A Architectural Plastic or Architectural Metal Cover Drop Plate Kit: For use with architectural plastic or metal cover installations when a 3146 plate is needed as a drop plate on a narrow top rail and the closer back is exposed. Kit contains a 3146 Drop Plate and a 3545A Decorative Plate.

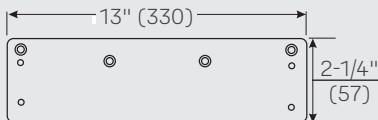

Note: All measurements are Inches/mm.



Regular Arm

BRACKETS FOR NON-HOLD OPEN ARMS

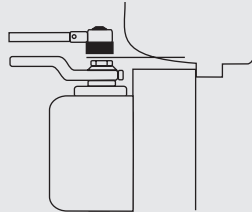
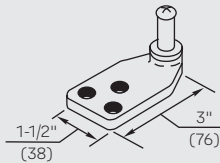

Molded / Bull Nose Trim - 291 Bracket: For use where the door frame has molded or bull nose trim which will not accept a standard non-hold open shoe. The bracket is mortised into the frame rabbet, and projects beyond the face of the frame. It will accommodate a frame rabbet up to 2" (51mm) deep.

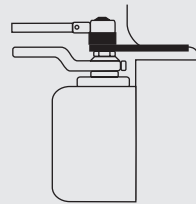
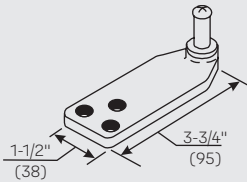

Molded / Bull Nose Trim - 291A Bracket: This bracket is similar to, but longer than, the 291 bracket. It is designed to accommodate frame rabbets from 2" to 2-7/8" (51 to 73mm) deep.

BRACKETS FOR HOLD OPEN ARMS

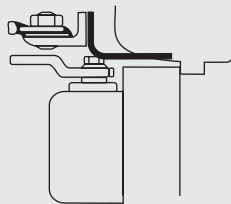
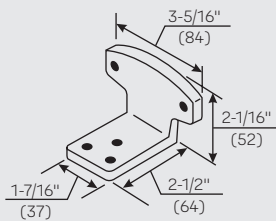

Molded / Bull Nose Trim - 292 Bracket: For use where the door frame has molded or bull nose trim which will not accept a standard hold open shoe. It is mortised into the frame rabbet, and projects beyond the face of the frame. It will accommodate a rabbet up to 2" (51mm) deep. This bracket is used in combination with the standard hold open mounting shoe.

Note: All measurements are Inches/mm.

Top Jamb Arm

CLOSER MOUNTING PLATES SLIM LINE INSTALLATIONS

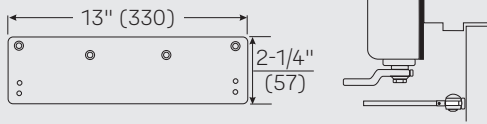

Low Ceiling Clearance - 3146 Drop Plate: For use where low ceiling clearance prevents normal top jamb mounting. This plate is used when clearance is from 1-7/8" to 2-7/8" (48mm to 73mm). Where ceiling clearance is less than 1-7/8" (48mm) see #3148 Drop Plate below.

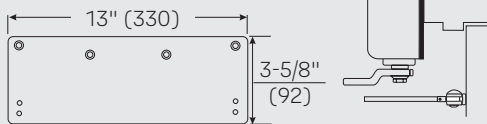

Overhead Door Holder - 3146 Drop Plate: For use where a surface or concealed overhead door holder prevents normal top jamb mounting. This plate drops the closer and allows arm mounting screws to clear the bottom of the door holder. This places the centerline of the arm mounting screws at 2-7/8" (73mm) from the top of the door.

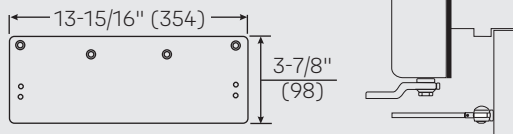

Low Ceiling Clearance - 3148 Drop Plate: For use where the ceiling clearance is between 1-1/2" and 1-3/4" (38 and 44mm).

METAL COVER INSTALLATIONS

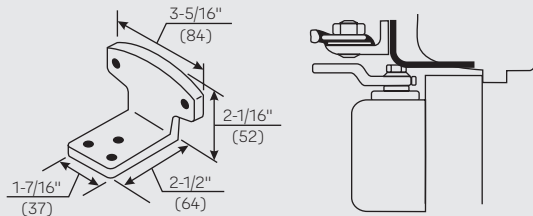

Low Ceiling Clearance - Overhead Door Holder - 3547 Metal Full Cover Drop Plate: For use where a low ceiling clearance prevents normal top jamb mounting. This plate is used when the clearance is between 1-5/8" and 3-7/8" (41mm and 98mm). Or for use where a surface or concealed overhead door holder prevents normal top jamb mounting of a closer with a metal full cover. This plate drops the closer and allows arm mounting screws to clear the bottom of the door holder. This places the centerline of the arm mounting screws at 3-7/8" (98mm) from the top of the door.

ARCHITECTURAL PLASTIC OR METAL COVER INSTALLATIONS

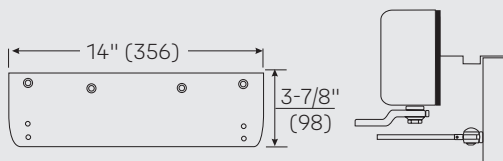

Low Ceiling Clearance - Overhead Door Holder - 3547A Architectural Plastic or Architectural Metal Cover Drop Plate: For use where low ceiling clearance prevents normal top jamb mounting. This plate is used when the clearance is between 1-5/8" and 3-7/8" (41mm and 98mm). Also for use where a surface or concealed overhead door holder prevents normal top jamb mounting of a closer with an architectural plastic or metal full cover. This plate drops the closer and allows arm mounting screws to clear the bottom of the door holder. This places the centerline of the arm mounting screws at 3-7/8" (98mm) from the top of the door.

Note: All measurements are Inches/mm.



Parallel Arm

CLOSER MOUNTING PLATES SLIM LINE INSTALLATIONS	
	<p>Narrow Top Rail - 3148 Drop Plate (3300 Series): For use where a narrow top rail prevents the closer from being mounted directly to the door surface. This drop plate can be used to mount a closer on a top rail as narrow as 2-7/8" (73mm) in height.</p>
FULL COVER INSTALLATIONS	
	<p>Exposed Back - 3445 Molded Full Cover Decorative Back Plate: For use on doors with glass lights where a closer with molded full cover is installed and the closer back is exposed. This plate covers the back of the installation to give a pleasing appearance from the reverse side.</p>
	<p>Exposed Back/Narrow Top Rail - 3158 Molded Full Cover Drop Plate: For use on doors with glass lights where a closer with molded full cover is installed and the back of the closer is exposed. This covers the back of the installation and gives a pleasing appearance from the reverse side.</p>
METAL COVER INSTALLATIONS	
	<p>Exposed Back - 3545 Metal Full Cover Decorative Back Plate: For use on doors with glass lights where a closer with full metal cover is installed and the back of the closer is exposed. This plate covers the back of the installation and gives a pleasing appearance from the reverse side.</p>
	<p>Exposed Back/Narrow Top Rail - 3548 Metal Full Cover Drop Plate: For use on doors with glass lights where a closer with metal full cover is installed on a narrow top rail, and the back of the cover is exposed. This drop plate can be used to mount a closer on a top rail as narrow as 2-7/8" (73mm) in height. This plate covers the back of the installation and gives a pleasing appearance from the reverse side.</p>
ARCHITECTURAL PLASTIC OR METAL COVER INSTALLATIONS	
	<p>Exposed Back - 3545A Architectural Plastic or Architectural Metal Cover Decorative Back Plate: For use on doors with glass lights where a closer with an architectural plastic or metal cover is installed and the closer back is exposed. This plate covers the back of the installation to give a pleasing appearance from the reverse side.</p>
	<p>Exposed Back/Narrow Top Rail - 3548A Architectural Plastic or Architectural Metal Cover Drop Plate: For use on doors with glass lights where a closer with an architectural plastic or metal cover is installed on a narrow top rail, and the back of the cover is exposed. This drop plate can be used to mount a closer on a top rail as narrow as 2-7/8" (73mm) in height. This plate covers the back of the installation to give a pleasing appearance from the reverse side.</p>

Note: All measurements are Inches/mm.

Parallel Arm - Brackets For Non-Hold Open Arms

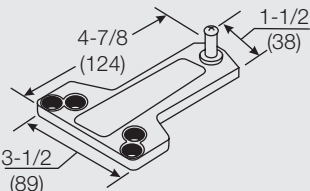
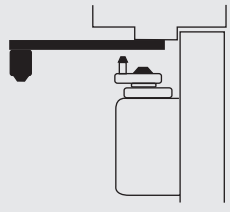
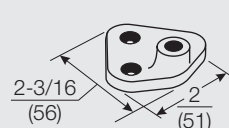
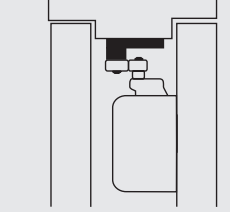
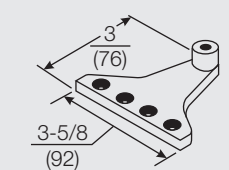
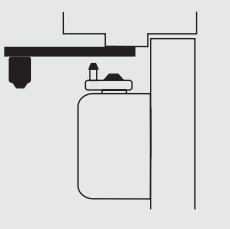
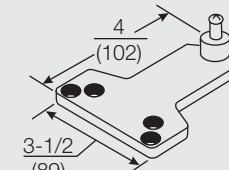
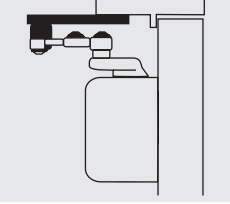
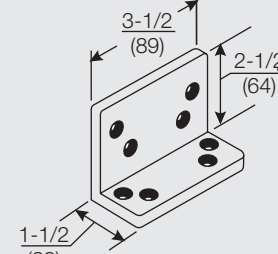
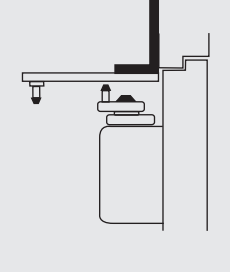
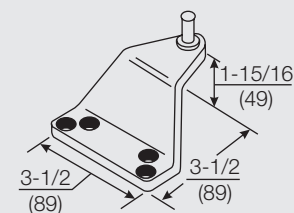
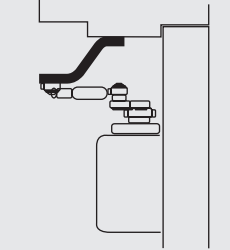
		<p>Standard Installation - 289A Soffit Plate: This soffit plate is supplied standard with parallel arm closers. It can be mounted where the frame soffit is as narrow as 1" (25 mm).</p>
		<p>Mounting between Doors - 413A Soffit Bracket: For use where insufficient space between companion doors does not permit use of other soffit plates. This bracket permits mounting of the closer between doors with as little as 3" (76mm) of header space. Permits closer arm to clear up to 5/8" (16mm) high stop.</p>
		<p>Narrow Frame/Removable Stop - 297 Soffit Plate: For use where a narrow frame or frame with removable stop does not permit use of the standard soffit plate. This soffit plate may be mounted on the frame soffit or the frame rabbet where the stop does not exceed 5/8" (16mm) in height. All of the screw holes are in a straight line, requiring as little as 1-1/4" (32mm) of frame reveal to mount bracket and maintain good closer arm geometry. Where the frame soffit is as wide as 2" (51mm), this soffit plate may be used to clear weather-stripping that is up to 1-3/8" (35mm) wide and 5/8" (16mm) in height.</p>
		<p>Blade/Applied Stop - 299 Soffit Plate: For use where a blade or applied stop does not permit installation of the standard soffit plate. Mounts to either the frame soffit or rabbet. Since this soffit plate projects 7/8" (22mm) less than a standard soffit plate, it requires a minimum frame reveal of 1-1/2" (38mm). Permits closer to clear up to a 5/8" (16mm) stop.</p>
		<p>Flush Transom - 589L Angle Bracket: For use where rabbeted or flush transom conditions prevent installation of a soffit plate. Used in combination with the 289 soffit plate, or may be used in combination with the 290 soffit plate when it is necessary for the closer arm to clear a separate overhead door holder.</p>
		<p>Extra-Clearance - 290 Offset Soffit Plate: For use where the need for additional clearance prevents use of the standard soffit plate. This plate mounts to the frame soffit to provide up to 2" (51mm) of clearance when a separate overhead door holder is used. Standard mounting requires a 2-5/8" (67mm) wide frame soffit. It may also be used where unusually high frame stops or weather-stripping prevent the use of other soffit plates.</p>

Note: All measurements are Inches/mm.



Parallel Arm - Brackets For Non-Hold Open And Hold Open Arms

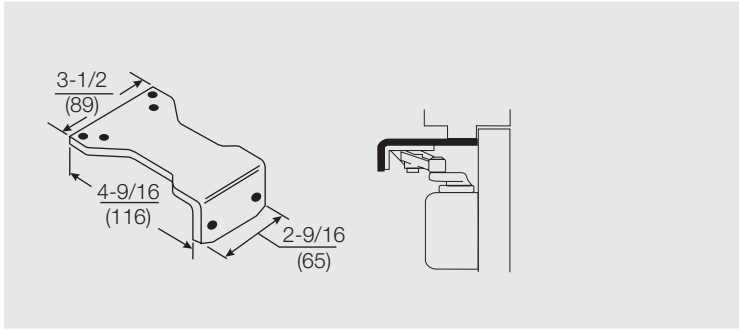

Parallel Hold Open - 588 Adapter Plate: Supplied standard with all parallel arm hold open closers. It can also be used to convert regular arm or top jamb hold open arms to parallel arm installation. It can be mounted where the frame soffit is as narrow as 1" (25mm).

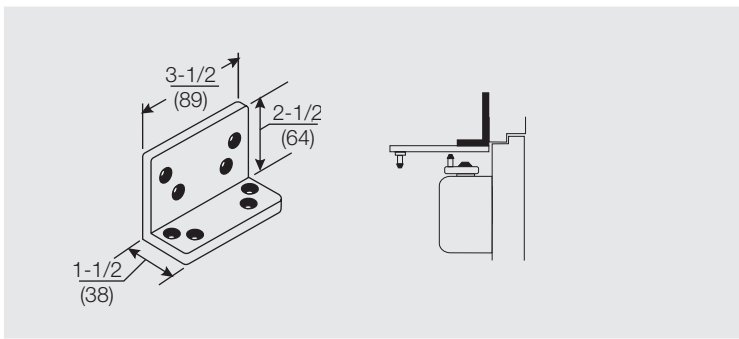

Flush Transom - 589L Angle Bracket: For use where rabbeted or flush transom conditions prevent installation of a soffit plate. Used in combination with the 588 adapter plate, this bracket fastens to the overhead transom to provide a mounting surface for the soffit plate assembly.

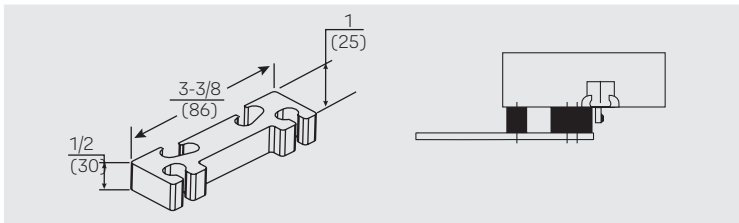

Clearance/Support Blade Stop - 891 Spacer Block: For use where the door frame has a blade stop and the soffit plate must be mounted on the frame rabbet. This accessory is used in combination with the standard spacer block to provide clearance of the blade stop. Also used with non-hold open arms.

Note: All measurements are Inches/mm.

Parallel Rigid, Holder/Stop, Holder/Stop Spring Arms

CLOSER MOUNTING PLATES SLIM LINE INSTALLATIONS

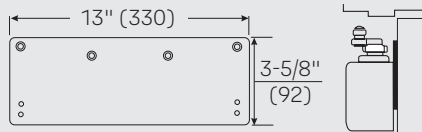

Narrow Top Rail - 3148 Drop Plate: For use where a narrow top rail prevents the closer from being mounted directly to the door surface. This drop plate can be used to mount a closer on a top rail as narrow as 2-9/16" (65mm) in height.

FULL COVER INSTALLATIONS

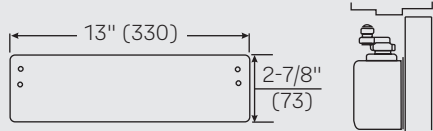

Exposed Back - 3445 Molded Full Cover Decorative Back Plate: For use on doors with glass lights where a closer with molded full cover is installed and the closer back is exposed. This plate covers the back of the installation to give a pleasing appearance from the reverse side.

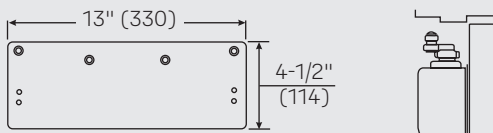

Exposed Back/Narrow Top Rail - 3158 Molded Full Cover Drop Plate: For use on doors with glass lights where a closer with molded full cover is installed and the back of the closer is exposed. This covers the back of the installation and gives a pleasing appearance from the reverse side.

METAL COVER INSTALLATIONS

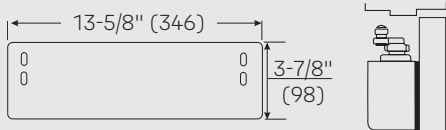

Exposed Back - 3545 Metal Full Cover Decorative Back Plate: For use on doors with glass lights where a closer with full metal cover is installed and the back of the closer is exposed. This plate covers the back of the installation and gives a pleasing appearance from the reverse side.

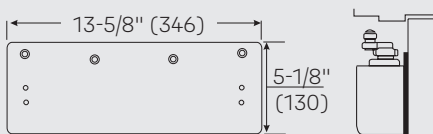

Exposed Back/Narrow Top Rail - 3548 Metal Full Cover Drop Plate: For use on doors with glass lights where a closer with metal full cover is installed on a narrow top rail, and the back of the cover is exposed. This drop plate can be used to mount a closer on a top rail as narrow as 2-9/16" (65mm) in height. This plate covers the back of the installation and gives a pleasing appearance from the reverse side.

ARCHITECTURAL PLASTIC OR METAL COVER INSTALLATIONS

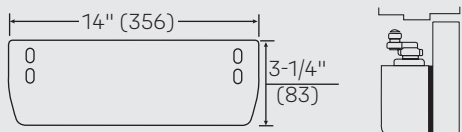

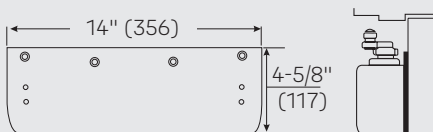

Exposed Back - 3545A Architectural Plastic or Architectural Metal Cover Decorative Back Plate: For use on doors with glass lights where a closer with an architectural plastic or metal cover is installed and the closer back is exposed. This plate covers the back of the installation to give a pleasing appearance from the reverse side.



Exposed Back/Narrow Top Rail - 3548A Architectural Plastic or Architectural Metal Cover Drop Plate: For use on doors with glass lights where a closer with an architectural plastic or metal cover is installed on a narrow top rail, and the back of the cover is exposed. This drop plate can be used to mount a closer on a top rail as narrow as 2-9/16" (65mm) in height. This plate covers the back of the installation to give a pleasing appearance from the reverse side.

Note: All measurements are Inches/mm.

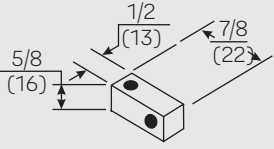
Parallel Rigid, Holder/Stop, Holder/Stop Spring Arms

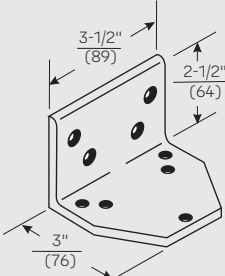
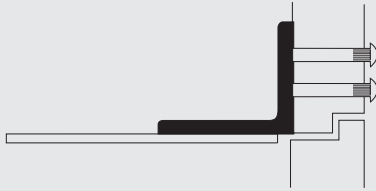
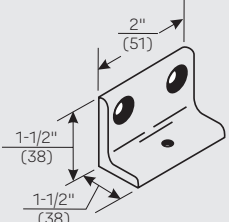
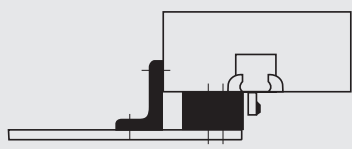
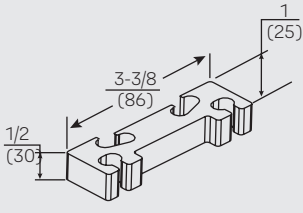
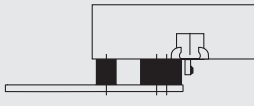
BRACKETS FOR NON-HOLD OPEN ARMS & HOLD OPEN ARMS	
 	<p>Standard - 293S Spacer Block: For use where a narrow frame soffit does not provide adequate support for the soffit plate. Supplied as standard with all parallel rigid arm closers.</p>
 	<p>Flush Rabbeted Transom - 293L Angle Bracket: For use where flush transom conditions prevent mounting of the standard soffit plate. This bracket is used in combination with the standard soffit plate.</p>
 	<p>Narrow Frame - 890 Support Bracket: For use where the frame is narrow and the soffit plate cannot be mounted directly to the frame soffit or rabbet. Used in combination with the #891 Spacer Block on blade stop frames to provide extra support and needed clearance of the blade stop. Used on frame where the frame doesn't exceed 5/8" (16mm) in height.</p>
 	<p>Clearance/Support Blade Stop - 891 Spacer Block: For use where the door frame has a blade stop and the soffit plate must be mounted on the frame rabbet. This accessory is used in combination with the standard spacer block to provide clearance of the blade stop. Also used with non-hold open arms.</p>

Note: All measurements are Inches/mm.

UNI Stop™ Arm

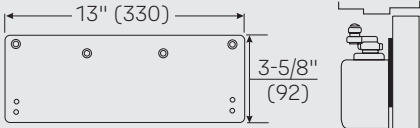
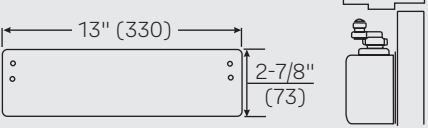
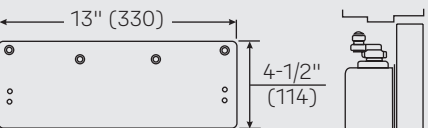
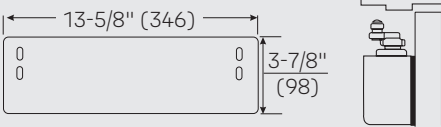
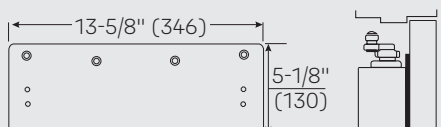
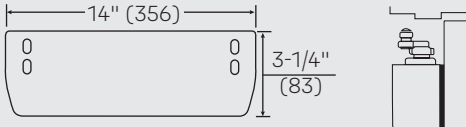
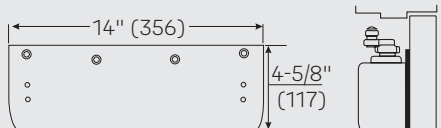
CLOSER MOUNTING PLATES PARALLEL ARM	
	<p>Narrow Top Rail - 3148 Drop Plate: For use where a narrow top rail prevents the closer from being mounted directly to the door surface. This drop plate can be used to mount a closer on a top rail as narrow as 2-7/16" (62mm) in height.</p>
FULL COVER INSTALLATIONS	
	<p>Exposed Back - 3445 Molded Full Cover Decorative Back Plate: For use on doors with glass lights where a closer with molded full cover is installed and the closer back is exposed. This plate covers the back of the installation to give a pleasing appearance from the reverse side.</p>
	<p>Exposed Back/Narrow Top Rail - 3158 Molded Full Cover Drop Plate: For use on doors with glass lights where a closer with molded full cover is installed and the back of the closer is exposed. This covers the back of the installation and gives a pleasing appearance from the reverse side.</p>
METAL COVER INSTALLATIONS	
	<p>Exposed Back - 3545 Metal Full Cover Decorative Back Plate: For use on doors with glass lights where a closer with full metal cover is installed and the back of the closer is exposed. This plate covers the back of the installation and gives a pleasing appearance from the reverse side.</p>
	<p>Exposed Back/Narrow Top Rail - 3548 Metal Full Cover Drop Plate: For use on doors with glass lights where a closer with metal full cover is installed on a narrow top rail, and the back of the cover is exposed. This drop plate can be used to mount a closer on a top rail as narrow as 2-9/16" (65mm) in height. This plate covers the back of the installation and gives a pleasing appearance from the reverse side.</p>
ARCHITECTURAL PLASTIC OR METAL COVER INSTALLATIONS	
	<p>Exposed Back - 3545A Architectural Plastic or Architectural Metal Cover Decorative Back Plate: For use on doors with glass lights where a closer with an architectural plastic or metal cover is installed and the closer back is exposed. This plate covers the back of the installation to give a pleasing appearance from the reverse side.</p>
	<p>Exposed Back/Narrow Top Rail - 3548A Architectural Plastic or Architectural Metal Cover Drop Plate: For use on doors with glass lights where a closer with an architectural plastic or metal cover is installed on a narrow top rail, and the back of the cover is exposed. This drop plate can be used to mount a closer on a top rail as narrow as 2-7/16" (62mm) in height. This plate covers the back of the installation to give a pleasing appearance from the reverse side.</p>

Note: All measurements are Inches/mm.



UNI Stop™ Arm

Closer Mounting Plate	
Soffit Plate Reinforcing Brackets (for Parallel Arm)	
	<p>Additional Support - 6190 Reinforcing Bracket: Standard for use with all parallel arm UNI Stop door controls. Provides additional support to the soffit plate on installations with door frame reveals from 1-7/8" to 4-5/8" (48 to 117mm).</p>
	<p>Flush Rabbeted Transom - 589L Angle Bracket: Optional for use with all parallel arm UNI Stop door controls. For use where rabbeted or flush transom conditions prevent installation of the soffit plate assembly. This bracket fastens to the overhead transom to provide a mounting surface for the soffit plate assembly.</p>
	<p>Wide Frame - 6191 Reinforcing Kit: Optional for use with all parallel arm UNI Stop door controls. Used to support the soffit plate on installations with wide frames. Clamps may be used with or without the spacer block, depending on frame conditions.</p>

Note: All measurements are Inches/mm.

UNI Stop™ Arm

CLOSER MOUNTING PLATES TOP JAMB

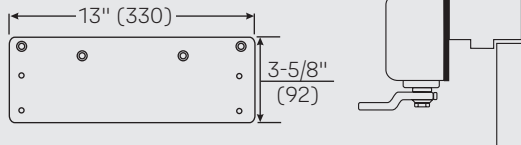

Narrow Top Rail - 3148 Drop Plate: For use where a narrow top rail prevents the closer from being mounted directly to the door surface. This drop plate can be used to mount a closer on a top rail as narrow as 2-7/16" (62mm) in height.

FULL COVER INSTALLATIONS

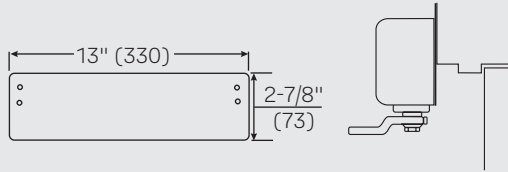

Exposed Back - 3445 Molded Full Cover Decorative Back Plate: For use on doors with glass lights where a closer with molded full cover is installed and the closer back is exposed. This plate covers the back of the installation to give a pleasing appearance from the reverse side.

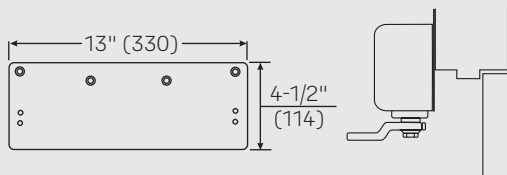

Exposed Back/Narrow Top Rail - 3158 Molded Full Cover Drop Plate: For use on doors with glass lights where a closer with molded full cover is installed and the back of the closer is exposed. This covers the back of the installation and gives a pleasing appearance from the reverse side.

METAL COVER INSTALLATIONS

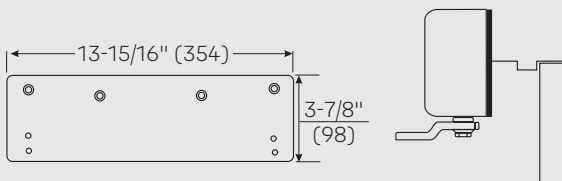

Low Ceiling Clearance - Overhead Door Holder - 3547 Metal Full Cover Drop Plate: For use where a low ceiling clearance prevents normal top jamb mounting. This plate is used when the clearance is between 1-5/8" and 3-3/4" (41mm and 95mm). Or for use where a surface or concealed overhead door holder prevents normal top jamb mounting of a closer with a metal full cover. This plate drops the closer and allows arm mounting screws to clear the bottom of the door holder. This places the centerline of the arm mounting screws at 3-7/8" (98mm) from the top of the door.

ARCHITECTURAL PLASTIC OR METAL COVER INSTALLATIONS

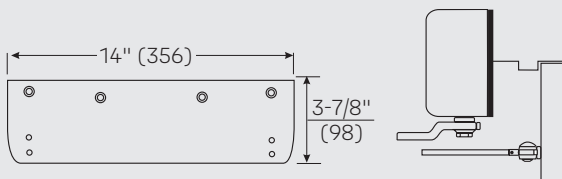

Low Ceiling Clearance - Overhead Door Holder - 3547A Architectural Plastic or Architectural Metal Cover Drop Plate: For use where low ceiling clearance prevents normal top jamb mounting. This plate is used when the clearance is between 1-5/8" and 3-3/4" (41mm and 95mm). Or for use where a surface or concealed overhead door holder prevents normal top jamb mounting of a closer with an architectural plastic or metal full cover. This plate drops the closer and allows arm mounting screws to clear the bottom of the door holder. This places the centerline of the arm mounting screws at 3-7/8" (98mm) from the top of the door.

Note: All measurements are Inches/mm.



Door Closer Body Assemblies

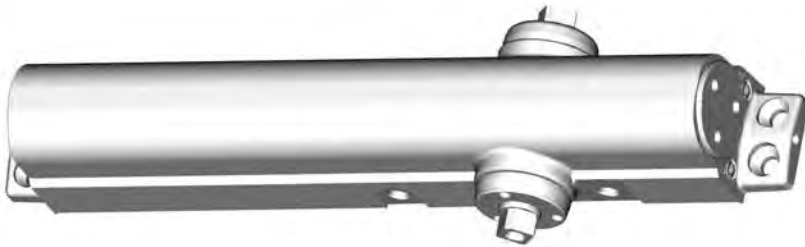

Model	Description
3101LAP	Multi-sized closer bodies 3101, 3301, 3501

LAP = Less All Parts

Closers	Type of Material			
	Plastic	Metal	Arch. Plastic	Arch. Metal
3301	3200P*	N/A	N/A	N/A
3501	3400P	3400M	3400A	3400MA

Fasteners

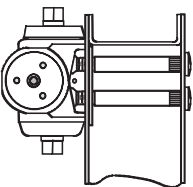

(Side view)

Steel Door Application		
Sex-nut / Sleeve-nut : "SN" (4 per pack) or Sex-nut / Sleeve-nut & Screw: "SNB" (4 per pack)		
Door	SN's	SNB's
1-3/4"	SN-134	SNB134-38
2"	N/A	SNB200-38
2-1/4"	SN-214	SNB214-38
S.S. SNB's 1-3/4"	SN-134SS	SNB134SS-38

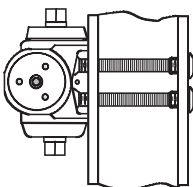

(Side view)

Aluminum and Wooden Door Application (Aluminum Door Shown)	
Through-bolt & Grommet Nut : "TBGN" (4 per pack)	
Door	TBGN's
1-3/8"	TBGN138-38
1-3/4"	TBGN134-38
2-1/4"	TBGN214-38

Note: All measurements are Inches/mm.

Covers

Cover Model	Cover Drawing
Slim Line* 3200P 1-3/4" high x 2-1/8" deep x 13" long (44 x 54 x 330)	
Full Plastic 3400P 2-7/8" high x 2-1/8" deep x 13" long (73 x 54 x 330)	
Full Metal 3400M 3-7/8" high x 2-3/16" deep x 13-5/8" long (98 x 56 x 346)	
Architectural Plastic 3400A 3-3/32" high x 2-1/4" deep x 13-7/8" long (79 x 57 x 352)	
Architectural Metal 3400MA 3" high x 2-3/16" deep x 13-15/16" long (76 x 56 x 354)	

Arm Type	Torx® Screw Packs
Reg., Par. & Top Jamb	TX38
Parallel Rigid, Holder/Stop	PRTX38
Regular Rigid Heavy-Duty Arm	RTX38
UNI Stop™ Arm	UNITX38

The 1639 pinion cap is NOT included with the 3200P cover. The cap is included with the complete closer package (3300, 3301).

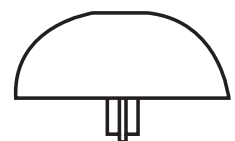

Parts

Non-Hold Open Arm Assemblies

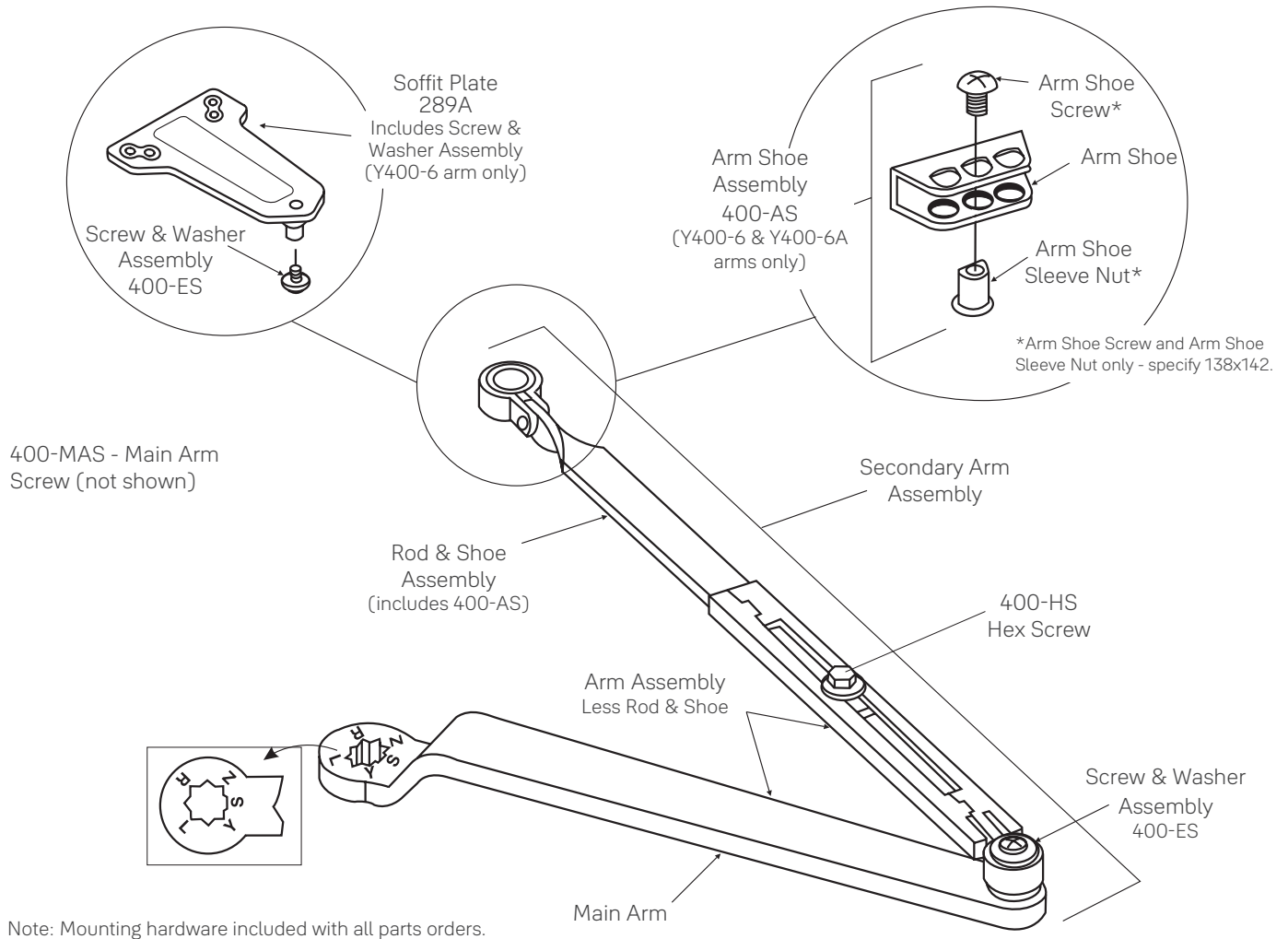

Note: Mounting hardware included with all parts orders.

Closer Series	Complete Arm Assembly	Main ¹ Arm Assembly (length)(mm) (includes 400-ES)	Secondary Arm Assembly (includes 400-ES)	Arm Assembly Less Rod and Shoe	Rod & Shoe ² Assembly (length)(mm)
3000	Y400-1	400-1M (11")(279)	Y400-111	Y400-1W	Y400-11 (8-7/8")(225)
TJ3000	Y400-1A		Y400-121		Y400-11A (12-9/16")(319)
P3000	Y400-6		Y400-116		Y400-16 (8-7/8")(225)
P3000 ³	Y400-6A		Y400-116A		Y400-16A (12-9/16")(319)
3000	Y400-26 (Tri-Packed [®] packaging includes Y400-1 plus 289A plate)				

1. C/L to C/L length shown in parentheses.

2. C/L of connecting link to end of rod shown in parentheses.

3. For 180° door swing when using a special template for doors hung on 6" to 8" (162mm to 203mm) wide throw hinges.



Hold Open Arm Assemblies

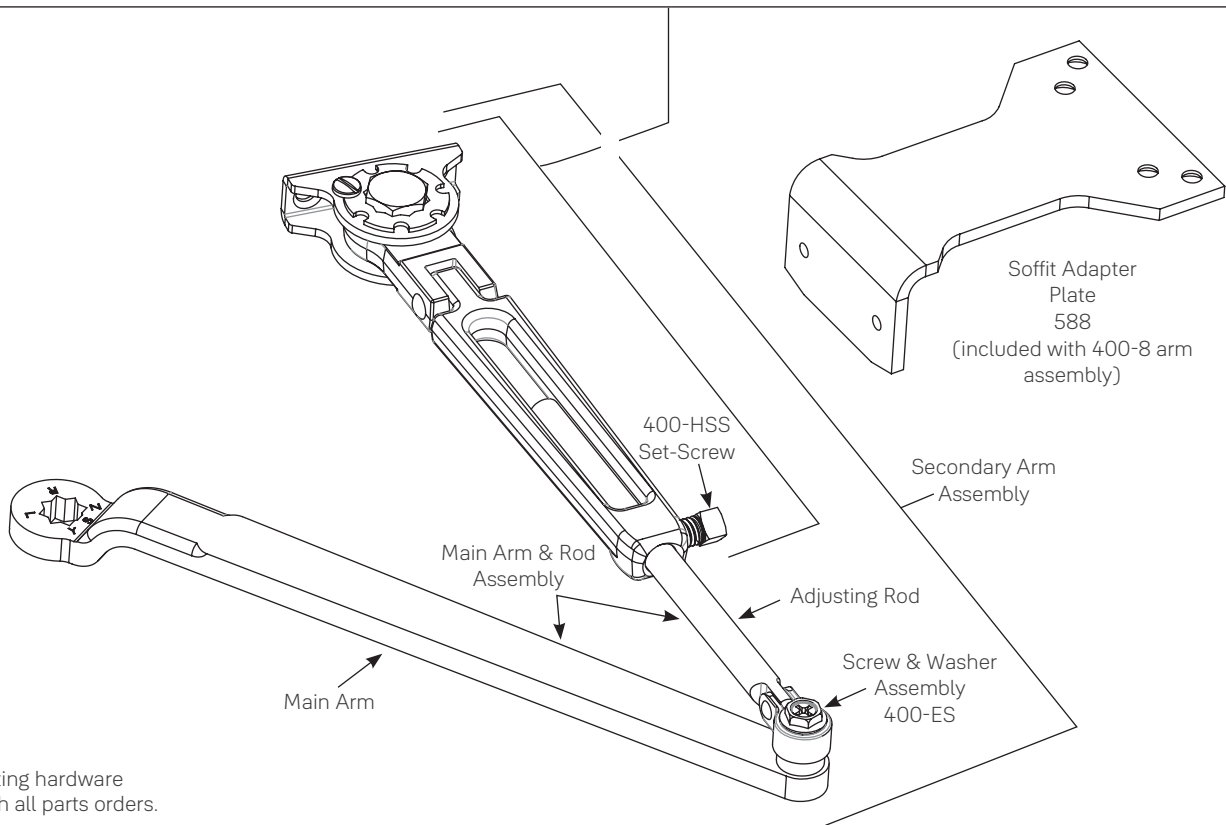
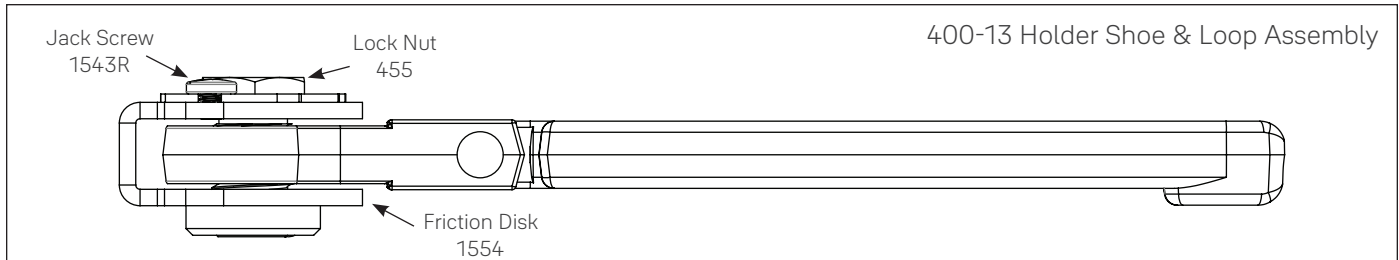

Note: Mounting hardware included with all parts orders.

Closer Series	Complete Arm Assembly	Main Arm ¹ (Length)(mm) (includes 400-ES)	Secondary Arm (includes 400-ES)	Main Arm & Rod Assembly	Holder Shoe & Loop Assembly	Adjusting Rod ² (length)(mm)
3010	400-3/ 400-8 ³	400-1M (11") (279)	400-113/400-118 (Reg.) / (Par.)	400-3W	400-13/400-18 ⁴ (Reg.)/(Par.)	400-31 (7-3/8") (187)
TJ3010	400-3A		400-123	400-3WA	400-13	400-31A (10-13/16") (275)

400-18- Holder Shoe & Loop Assembly (400-13) with Soffit Adapter Plate (588)

1. C/L to C/L length shown in parentheses.
2. C/L of connecting link to end of rod shown in parentheses.
3. Same as 400-3 but includes #588H soffit adapter plate.
4. Same as 400-13 but includes #588H soffit adapter plate

Parts

Parallel Rigid Arm Assemblies

Non-Hold Open Arm Shown

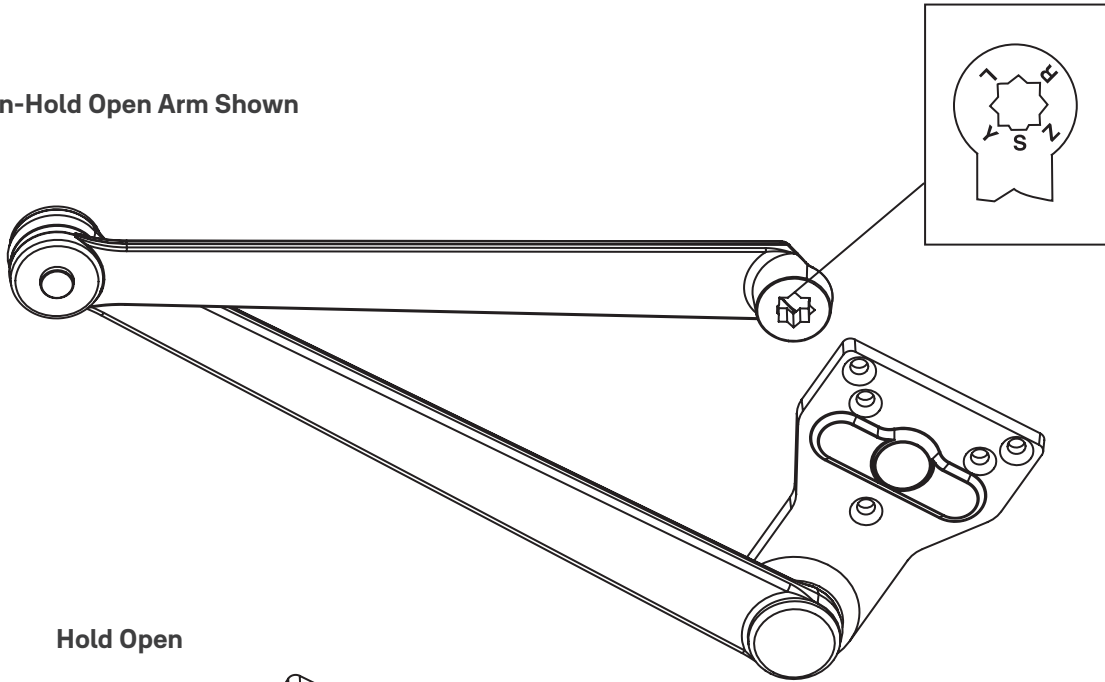

Hold Open

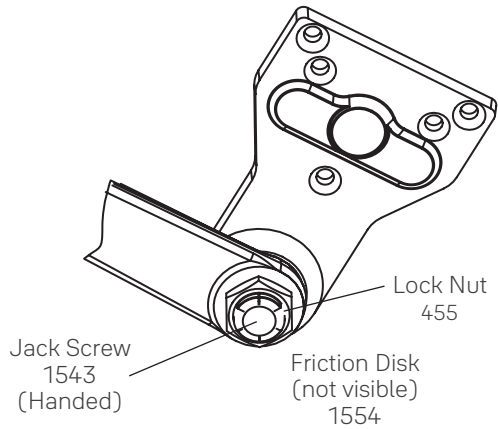

Note: Mounting hardware included with all parts orders.

Arm Function	Complete Arm Assembly
Non-Hold Open	PR400-5
Hold Open	PR400-8R (Right Hand)
	PR400-8L (Left Hand)

Holder/Stop Arm Assemblies

Hold Open Arm Shown

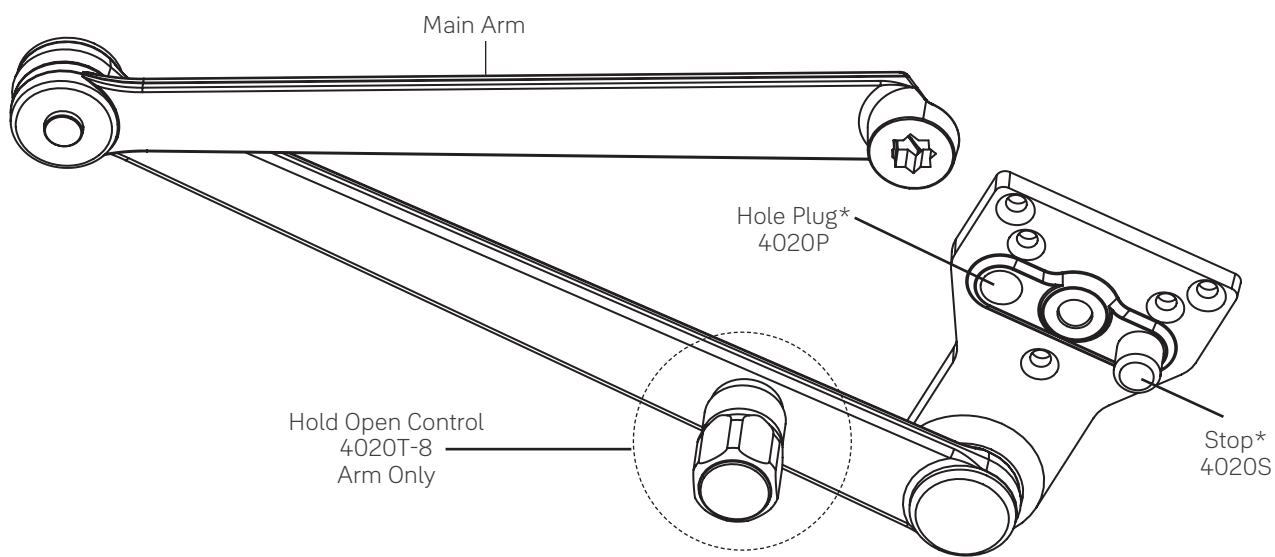

Note: Mounting hardware included with all parts orders.

Arm Function	Complete Arm Package
Non-Hold Open	4020-5
Thumbturn Hold Open	4020T-8

*These parts and screw pack are included with complete arm assemblies.

Holder/Stop Spring Arm Assemblies

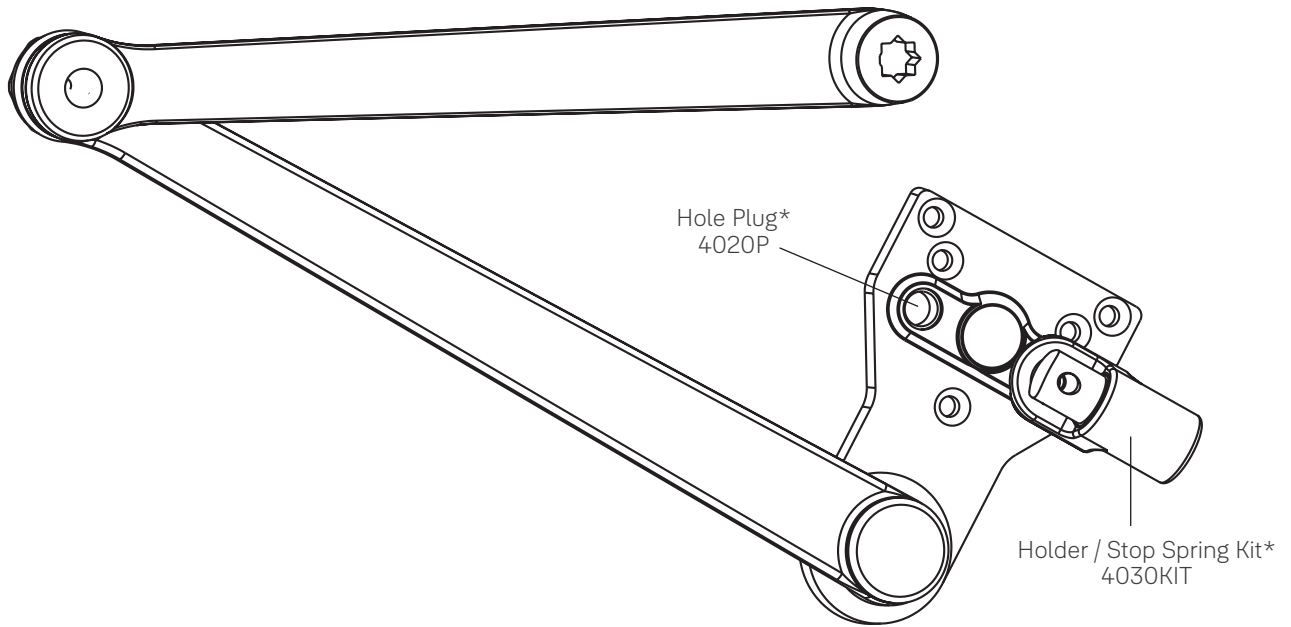

Note: Mounting hardware included with all parts orders.

Arm Function	Complete Arm Package
Non-Hold Open	4030-5
Thumbturn Hold Open	4030T-8

* These parts and screw pack are included with complete arm assemblies.

UNI Stop™ Arm Assemblies

Parallel Arm

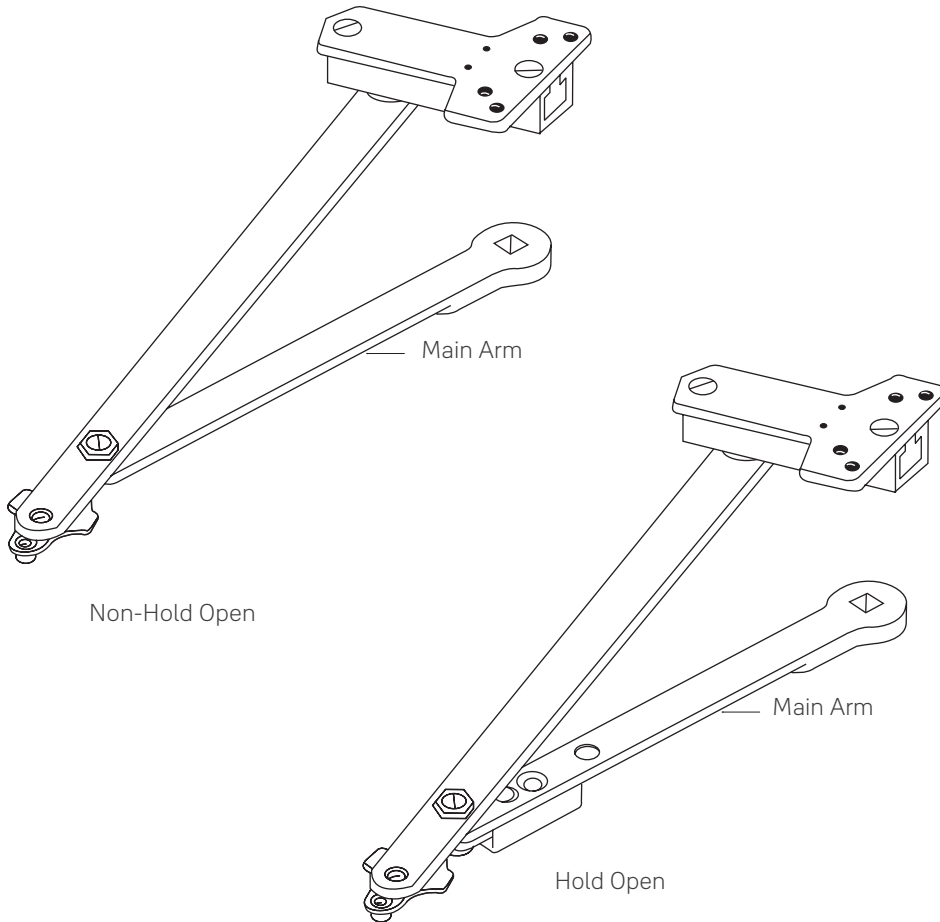

Note: Mounting hardware included with all parts orders.

Complete Arm Assembly			
Door Width (cm)	Main Arm Length* (mm)	Non-Hold Open	Hold Open
28" - 32" (71- 81)	9-1/2" (241)	6100-11	6100-1
33" - 41" (84 - 104)	11" (279)	6100-13	6100-3
42" - 48" (107 - 122)	12-1/2" (318)	6100-14	6100-4

Only available in painted finishes.

UNI Stop™ Arm Assemblies

Top Jamb

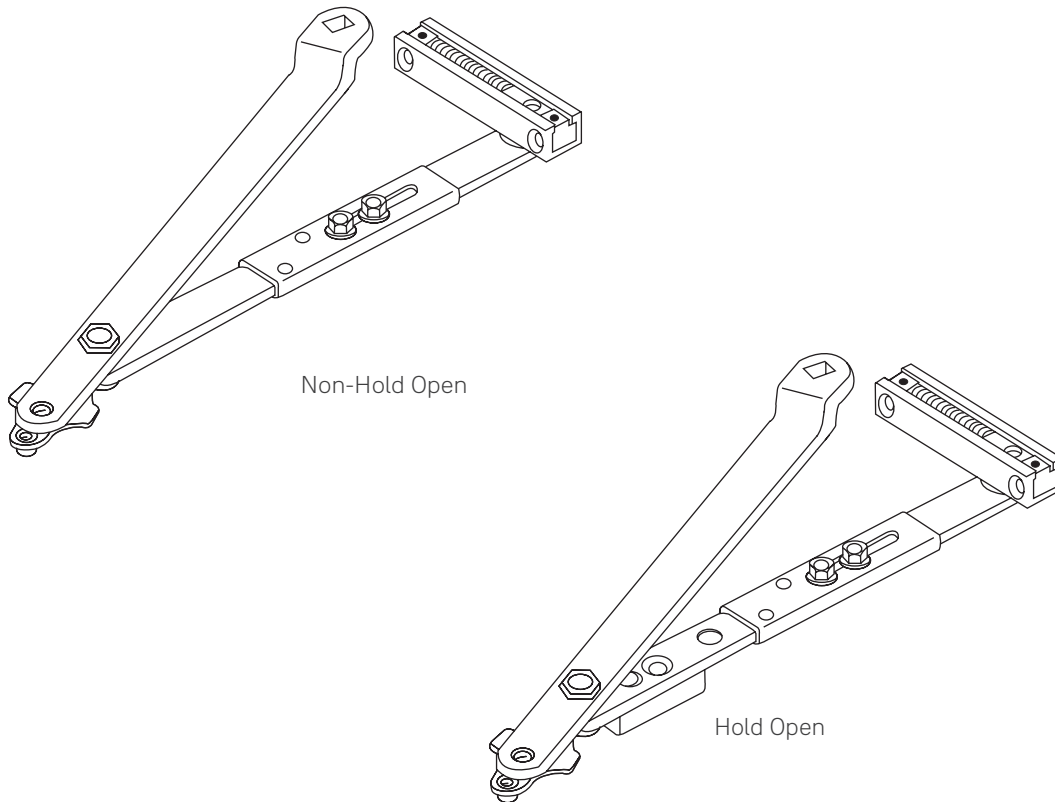

Note: Mounting hardware included with all parts orders.

Complete Arm Assembly		For Frame Reveals (mm)
Non-Hold Open	Hold Open	
J6100-4	J6100-7	2-1/8" - 3-1/4" (54 - 83)
J6200-4	J6200-7	1/2" - 2" (13 - 51)
J6400-4	J6400-7	3-3/8" - 4-1/4" (86 - 108)
J6500-41	J6500-71	4-3/8" - 5-3/8" (111 - 137)
J6500-42	J6500-72	5-1/2" - 6-3/8" (140 - 162)
J6500-43	J6500-73	6-1/2" - 7-3/8" (165 - 187)
J6600-4	J6600-7	0 - 3/8" (0 - 10)

Only available in painted finishes.



Low Profile Arm Assemblies

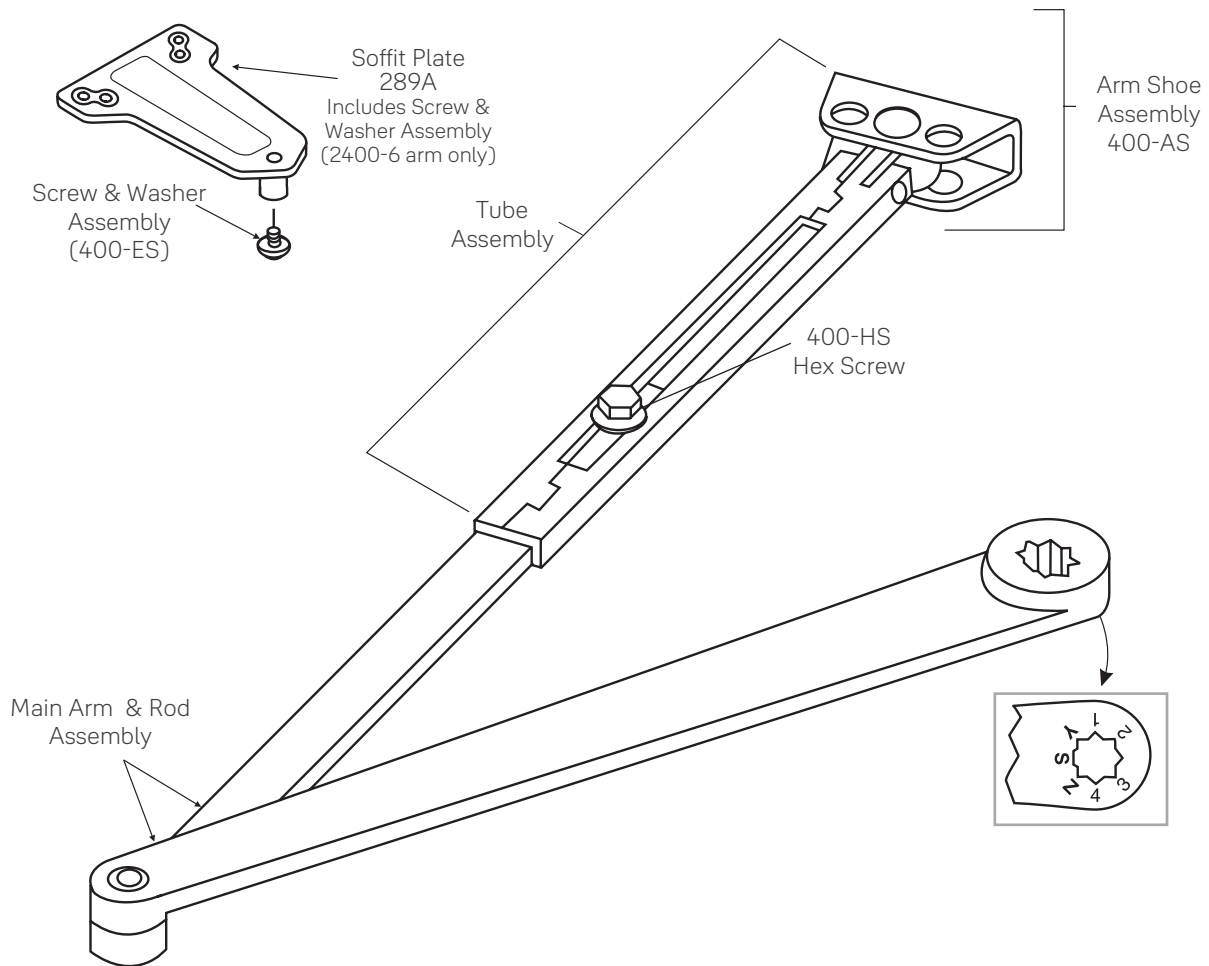

Note: Mounting hardware included with all parts orders.

Arm Application	Complete Arm Assembly	Main Arm & Adjusting Rod Assembly	Tube & Shoe/Soffit Assembly
Regular Arm	2400-1	2400-1MR	2400-1TS (With 400-AS)
Parallel Arm	2400-6		2400-6TS (With 289A)
Tri-Packed® Packaging	2400-26		



Suggested Specification

3301/3501Series

Closers for interior and exterior doors shall be full rack-and-pinion type with cast aluminum alloy shell. Closers shall be surface mounted and shall project no more than 2-1/8" from the surface of the door with standard cover. Closers shall be non-handed to permit installation on doors of either hand. Closer fluid shall contain lubricity and anti-oxidation agents. Closer fluid shall maintain stable viscosity to allow door closer to perform in temperatures ranging from extremely high to as low as -40°F. Closers shall have multi-size spring power adjustment to permit setting of spring from size 1 through size 6. Closers shall have two non-critical valves, hex key adjusted, to independently regulate sweep speed and latch speed. Closers shall have adjustable backcheck intensity controlled by a hex key adjusted valve.

[Closers shall have adjustable delayed action closing controlled by a hex key adjustable valve.]

Regular arm and top jamb closers shall have a non-hold open shoe permitting 15% (+ or – 7-1/2%) power adjustment. **Closers shall be enclosed in a [molded resin cover] [plated or sprayed metal cover], Closers to be Yale® [3301/3501] [3501M] [3501MA] [3501A].

**For special arms insert that specification here (see column three on this page).

****UNI Stop™ Arm**

Door closers shall have a fixed door stop feature effective at one point selected at installation, from 85° - 110° in five-degree increments. Door stop shall be cushioned by a shock-absorbing heavy-duty spring action effective at the [soffit plate] [arm shoe] pivot. [Closers shall be provided for parallel arm installation using a rigid steel main arm and secondary arm lengths proportional to the door width.] [Closers shall be provided for top jamb installation using a forged steel, rigid main arm and telescoping secondary arm adequate for the frame reveal of the openings.]

****Holder/Stop Arm**

Door closers shall have a field reversible door stop. Door closer shall have a feature with selectable on and off ball and detent hold open. Hold open tension shall be adjustable effective at one point selected at installation, from 85° - 110° in five degree increments. [Hold open mechanism shall have engage/disengage selection actuated by thumbturn]. Closers shall be provided for parallel arm installation using a forged rigid steel main arm and secondary arm.

****Holder/Stop Spring Arm**

Door closers shall have built-in door stop [and holder] effective at one point selected at installation, from 85° - 110° in five-degree increments. Door stop mechanism shall be reversible and have a buffer spring that engages prior to the dead stop feature, reducing shock loads to the door and frame assembly. Door stop mechanism shall be non-handed and attached to soffit plate. [Hold open mechanism shall have engage/disengage selection actuated by thumbturn]. Closers shall be provided for parallel installation using a forged rigid steel main arm and secondary arm.



Trusted every day

Customer Service Phone:

1-800-438-1951

Customer Service Fax:

1-800-338-0965

24/7 Support Phone:

1-855-213-5841

24/7 Support Email:

Support@YaleLock.com

Website:

yalecommercial.com

Email for orders:

orders.yaleus@assaabloy.com

Contact Us

U.S.A.

Yale Locks & Hardware

Address: 225 Episcopal Road

Berlin, CT 06037-4004

Tel: 1-800-438-1951

Fax: 1-800-338-0965

yalecommercial.com

Canada:

ASSA ABLOY Door Security Solutions Canada

Address: 160 Four Valley Drive

Vaughan, Ontario L4K 4T9

Tel: 1-800-461-3007

Fax: 1-800-461-8989

assaabloydss.ca

International:

ASSA ABLOY Americas International

Tel: 1-905-821-7775

Fax: 1-905-821-1429

assaabloyai.com

THE YALE BRAND, with its unparalleled global reach and range of products, reassures more people in more countries than any other consumer locking solution.

THE ASSA ABLOY GROUP is the world's leading manufacturer and supplier of locking solutions, dedicated to satisfying end-user needs for security, safety and convenience.

Yale Commercial is a business associated with ASSA ABLOY Access and Egress Hardware Group, Inc., an ASSA ABLOY Group company. Copyright © 2001-2021, ASSA ABLOY Access and Egress Hardware Group, Inc. All rights reserved. Reproduction in whole or in part without the express written permission of ASSA ABLOY Access and Egress Hardware Group, Inc. is prohibited. Patent pending and/or patent www.assaabloydss.com/patents.



2700 Series

Architectural Door Closers



An ASSA ABLOY Group brand

ASSA ABLOY



Introduction

CONTENTS

Introduction	2
Features & Benefits	3
Compliance Standards	4
Door Closing Latching Cycle	4
Finishes	5
How To Order	6
Applications.....	7
Parts	8
Accessories.....	9

2700 SERIES DOOR CLOSER

Yale® 2700 series architectural door closers are ideal for commercial applications where ease of use, installation and aesthetics are required at an economical price.

The 2700 series features rugged construction, adjustments for backcheck, closing and latch speed, rack and pinion operation and a variety of arm options.

Bringing you a dependable door closer at an attractive price point, Yale Works for YouSM.



Features & Benefits



FEATURES

- Adjustable spring sizes 1-6
- Non-handed
- Aluminum body
- Tri-packed: regular, parallel or top jamb mounting
- Full plastic cover
- Hold open and heavy-duty arms available
- Sleeve nuts furnished standard with all models
- Optional fasteners: through-bolts and grommet nuts

BENEFITS

- **Accessible:** Rugged construction allows for ease of use and installation; Tri-packed closer allows installation of multiple applications
- **Economical:** 10-year limited warranty; Longer life results in fewer replacements and less material used
- **Customizable:** Non-handed for right or left hand installation; Adjustable 1-6 spring simplifies installation; Adjustments for backcheck, closing and latch speed, rack and pinion operation; Variety of arm options



FUNCTIONS

- Backcheck
- Closing speed
- Latching speed
- Delayed action; specify 2701DL



Overview

COMPLIANCE STANDARDS

- Certified for ANSI/BHMA A156.4 Grade 1 **BHMA CERTIFIED**
- UL and cUL listed. This includes compliance to UL10C. 
- Meets requirements for Americans with Disabilities Act (ADA) and ANSI/BHMA A117.1 
- 10-year limited warranty

CAUTION: Door Closers for Low Opening Force

Applications:

Door closers installed in openings required to meet the requirements of the Americans With Disabilities Act or ANSI/BHMA Standard A117.1, when adjusted to meet those requirements, may not provide adequate closing power to dependably close and latch the door based on opening or site conditions.

DOOR CLOSING LATCH CYCLE

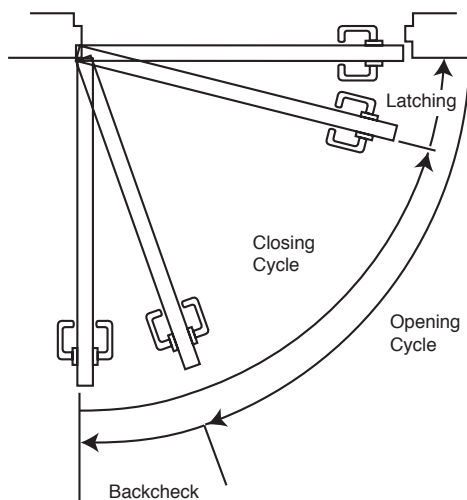

ARMS

Non-Hold Open

Self-closes door every time door is opened. Auxiliary stop (by others) required except when using the Holder/Stop arm.



Hold Open

Achieved by means of friction or ball and detent/roller. Friction hold open has a range of 90° to 180° using template location and mechanical adjustment. Ball and detent or roller hold open is effective in a range of 85° to 110°.

Hold open arm door closers are not permitted to be used on fire door assemblies.

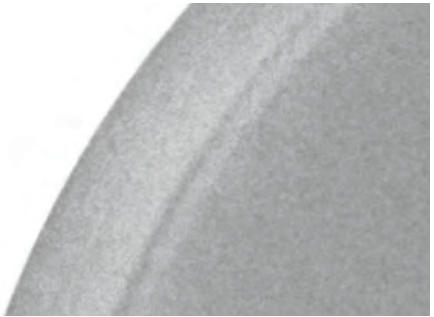

Finishes

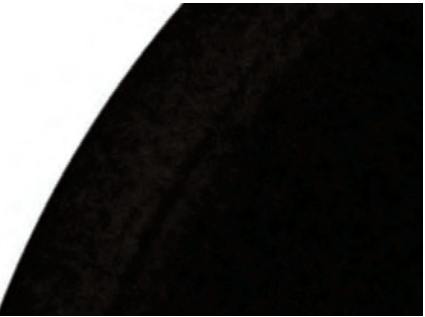
ANSI/BHMA Code Finish Description		
689 Aluminim Painted	690 Dark Bronze Painted	BSP Black Suede Powder Coat
		



How To Order

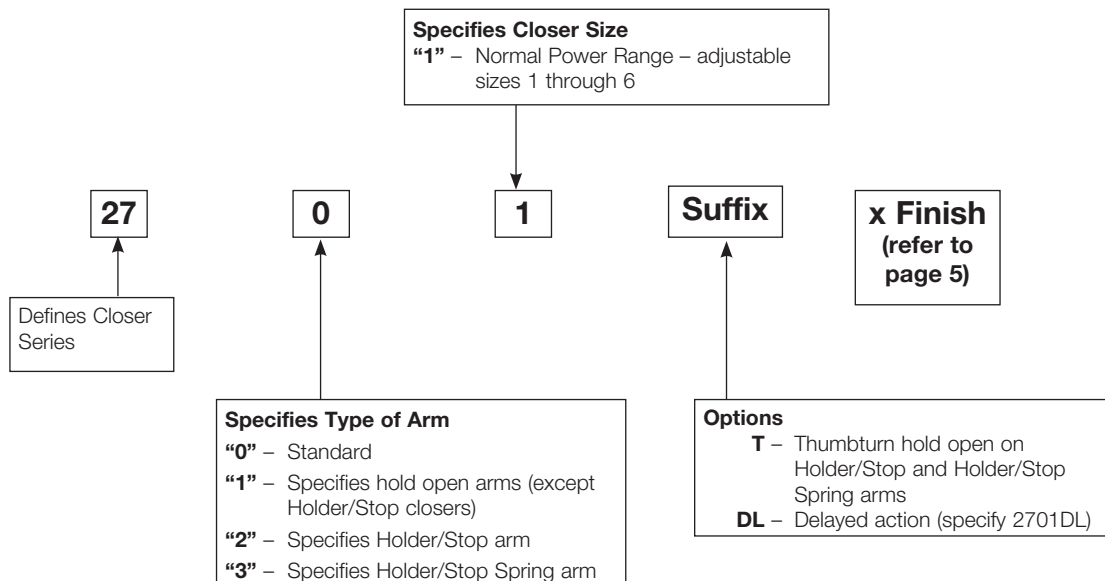

Notes:

- For heavy-duty parallel rigid arm applications, specify 2721 or 2721T, stop is removable.
- Door closer warranty becomes void if the closer is installed on the exterior side of a door in the exterior wall of a building.
- It is strongly recommended, and may be required on fire door assemblies, that doors having a door closer be hung on ball-bearing or anti-friction hinges or pivots. Consult local authority having jurisdiction.
- Failure to use fasteners supplied with closer may void factory warranty.
- Fasteners for fire/smoke door assemblies must conform to NFPA 80. In some applications additional fasteners may be mandated by NFPA 80 that are not shipped with standard Yale® product, such as sleeve-nuts/sex-nuts or thru bolts and grommet nuts.
- Information provided is based on 1-3/4" (44mm) x 7' (2.13m) standard weight doors swinging to 110°. Other conditions (such as door height or weight; or wind/draft conditions) may require adjustment of spring setting, selection of a larger size closer or different closer.

Applications

Regular Arm

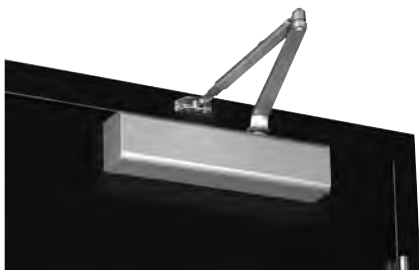

Non-hold open arm shown, hold open application available.

- Pull side application; double lever arm
- Sufficient frame, door and/or ceiling clearance must be considered
- Due to arm projection, application may present an aesthetics issue or be prone to vandalism

Top Jamb



Non-hold open arm shown, hold open application available.

- Push side application
- Sufficient frame face and/or ceiling clearance must be considered
- 2-1/4" (57mm) top rail on door is required
- Best door control for doors in exterior walls that swing out of building
- Consideration must be given to depth of reveal

Parallel Arm



Non-hold open arm shown, hold open application available.

- Push side application
- In the closed position, there is little or no hardware projection beyond the frame face
- Due to arm geometry, approximately 25% less power-efficient than regular arm application
- Closer and arm mounted below the frame stop

Holder/Stop Arm

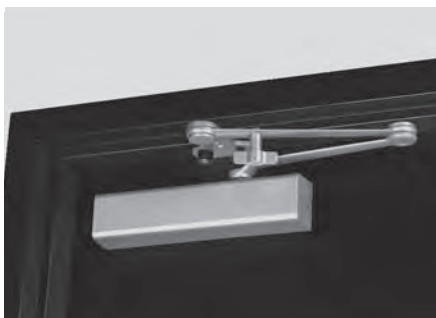

2721T (hold open) shown

- Holder/Stop arms incorporate a stop at the arm's soffit plate to dead stop the door at a predetermined degree of door swing between 85° and 110°, in 5° increments
- Prior to dead stop, backcheck slows the door speed to reduce the stop action
- Arm is intended for use where an auxiliary door stop cannot be used and low to moderate abuse is anticipated
- Stop is removable to allow for additional applications where auxiliary door stops are installed

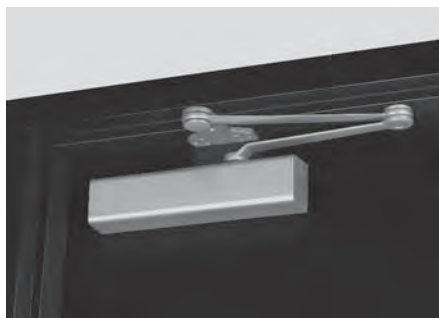

2721 (non-hold open, without stop) shown

- Holder/Stop Spring arms incorporate a buffer spring that provides greater protection at the end of the door opening cycle.
- Spring is removable

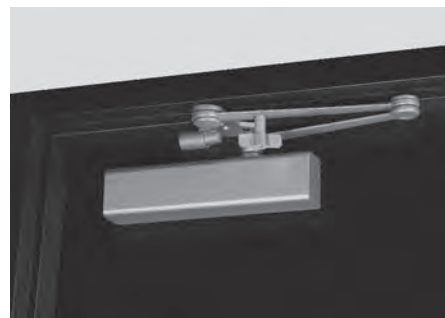

2731T (hold open with thumbturn and spring) shown

Consult factory if door weight exceeds 225 lbs.



Model/Part Numbers

Complete Units	
Model Number	Description
2701	Non-Hold Open Tri-Packed
2701DL	Non-Hold Open Tri-Packed with Delayed Action
2711	Hold Open Tri-Packed
2721	Heavy-Duty Non-Hold Open Parallel Arm with Removable Stop
2721T	Heavy-Duty Hold Open Parallel Arm with Thumbturn and Removable Stop
2731	Heavy-Duty Non-Hold Open Parallel Arm with Spring and Removable Stop
2731T	Heavy-Duty Hold Open Parallel Arm with Thumbturn and Spring and Removable Stop

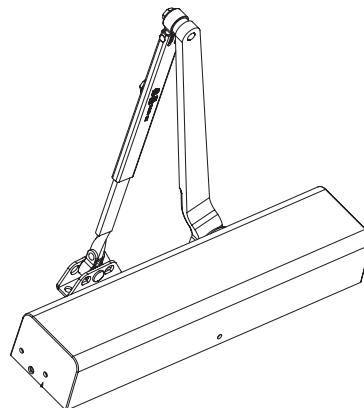

Note: for heavy-duty parallel rigid arm applications, specify 2721 or 2721T, stop is removable.

See page 6 for more how to order info.

Miscellaneous Parts*	
Part Number	Description
2700COV	Full Plastic Cover
2700SP	Screw Pack
2730Kit	Door Saver Spring Stop



2730Kit

*Specify finish when ordering.

Optional Fasteners	
Part Number	Description
TBGN134-38	Through-Bolts & Grommet Nuts

Note: Sleeve nuts furnished standard with all models.

Cover Dimensions		
Width	Length	Projection
2-7/8" (73mm)	13" (330mm)	2-1/8" (54mm)

Accessories

BRACKETS FOR NON-HOLD OPEN ARMS & HOLD OPEN ARMS

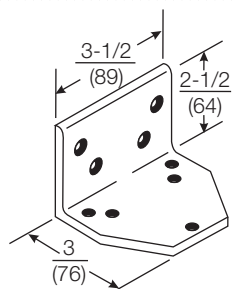

Flush Rabbeted Transom - 293L Angle Bracket: For use where flush transom conditions prevent mounting of the standard soffit plate. This bracket is used in combination with the standard soffit plate. Not for use with heavy-duty arms.

CLOSER MOUNTING PLATES

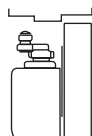
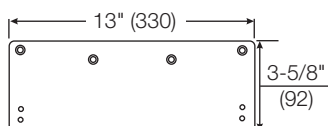

Narrow Top Rail - 3148 Drop Plate: For use where a narrow top rail prevents the closer from being mounted directly to the door surface. This drop plate can be used to mount a closer on a top rail as narrow as 2-7/16" (62mm) in height.

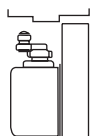
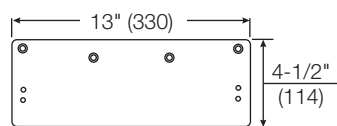

Exposed Back/Narrow Top Rail - 3158 Molded Full Cover Drop Plate: For use on doors with glass lights where a closer with molded full cover is installed and the back of the closer is exposed. This covers the back of the installation and gives a pleasing appearance from the reverse side.



Notes



Notes

Contact Us

The world's favorite lock



U.S.A.

Yale Locks & Hardware

Address: 225 Episcopal Road
Berlin, CT 06037-4004
Tel: 1-800-438-1951
Fax: 1-800-338-0965
yalelocks.com

Canada:

ASSA ABLOY Door Security Solutions Canada

Address: 160 Four Valley Drive
Vaughan, Ontario L4K 4T9
Tel: 1-800-461-3007
Fax: 1-800-461-8989
assaabloy.ca

International:

ASSA ABLOY Americas International

Tel: 1-905-821-7775
Fax: 1-905-821-1429
assaabloyai.com

Yale Commercial is a business associated with ASSA ABLOY Access and Egress Hardware Group, Inc., an ASSA ABLOY Group company. Copyright © 2012-2020, ASSA ABLOY Access and Egress Hardware Group, Inc. All rights reserved. Reproduction in whole or in part without the express written permission of ASSA ABLOY Access and Egress Hardware Group, Inc. is prohibited. Patent pending and/or patent www.assaabloydss.com/patents.

YALE, with its unique global reach and range of products, is the world's favorite lock.

ASSA ABLOY is the global leader in door opening solutions, dedicated to satisfying end-user needs for security, safety and convenience.

42821-6/20



51 Series Door Closers





Contents

Features & Benefits.....	3
Overview	4
Fasteners	4
Features	5
Finishes.....	6
How to Order.....	7
Applications	8
Technical Details	9-11
Accessories	12-16
Parts List	17-18
Sample Specification.....	19

51 Series Door Closers

Yale® 51 Series Closers are designed to fit almost any application and are the choice of engineers worldwide. They are ideal for use with aluminum store front doors and frames, yet they also complement wood or metal door installations. Non-handed, the 51 series is available as multi-sized units and offers tri-packed packaging on standard non-hold open and hold open closers.

This UL listed, Grade 1 closer has a proven history of quality and tradition. With a variety of plates, brackets, precise valve adjustment and a complete range of arms, these closers can be used on retail stores, warehouses, restaurants, garages, or manufacturing and utility buildings. With a full feature set and stylish design, Yale Works for YouSM.



Features

- Exceeds 25 million cycles
- Non-handed
- Tri-packed (regular arm, top jamb and parallel arm installations)
- Rack-and-pinion design
- Cast aluminum body
- 1-3/8" (35mm) diameter piston
- 5/8" (16mm) diameter pinion journals
- Standard, separate and independent, latch, sweep and backcheck intensity valves
- 2-7/8" (73mm) projection
- All standard arm applications allow doors to swing 180°, conditions permitting
- 30-year limited warranty
- Staked valves

Benefits

- **Reliable:** High strength aluminum alloy closer body provides for long life; independent latch, sweep and backcheck intensity valves ensure positive control
- **Cost of Ownership:** Exceeds 25 million cycles; 30-year limited warranty
- **Flexible:** Adjustable 1-6 spring makes installation selection easier and reduces inventory for customers; Non-handed for installation on right- or left-hand swing doors

Overview



Cutaway View

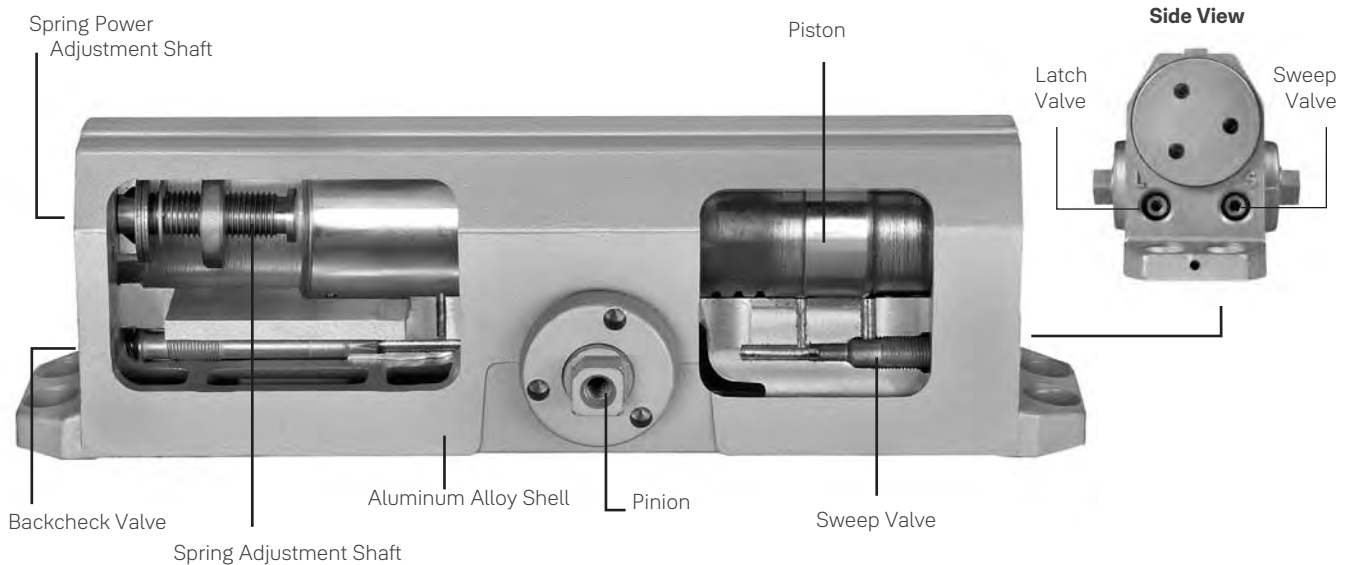

Spring omitted for illustration purposes

Compliance Standards

The series 51 door closers are designed to comply with requirements of the Americans with Disabilities Act (A.D.A.) and ANSI standard A117.1. All series 51 are ANSI/BHMA A156.4, Grade 1 certified. All Yale® series 51 closers with non-hold open arms are listed by Underwriters' Laboratories for labeled fire doors . This includes compliance to UL10C for 3-hour assemblies. These products are manufactured in a certified ISO 9001, ISO 14001 facility.

CAUTION: Door Closers for Low Opening Force Applications:

Door closers installed in openings required to meet the requirements of the Americans With Disabilities Act or ANSI/BHMA Standard A117.1, when adjusted to meet those requirements, may not provide adequate closing power to dependably close and latch the door based on opening or site conditions.

Fasteners

Type	0.1795 in	Arm		
		RA	PA	TJ
DOOR				
SDST	Self Drilling Self Tapping	S	S	S
MS	Machine Screw	S	S	S
SN	Sleeve Nut	O	O	O
TBGN	Thru Bolts & Grommet Nuts	O	O	O
SMS	Sheet Metal Screws (Wood)	O	O	O
FRAME				
SDST	Self Drilling Self Tapping	S	S	S
MS	Machine Screw	S	S	S
SMS	Sheet Metal Screws (Wood)	O	O	O

S = standard; O = optional

SN are for use on unreinforced hollow metal doors or to prevent any hollow metal door from collapse/dimpling. They can also be used for thru bolting on wood doors. SN are supplied for 1-3/4" (44mm) thick doors unless specified for 2-1/4" (57mm) thick doors.

TBGN are an alternative to SN for wood doors. TBGN are supplied standard for 1-3/4" (44mm) thick doors. They can be specified for 1-3/8" (35mm) thick doors.

SMS - when specified, closer will be packed with sheet metal screws for the door **AND** sheet metal screws plus machine screws for the frame.



Features

Standard Features

Aluminum Alloy Housing

Closer bodies are constructed of a special aluminum alloy, carefully selected to accommodate interaction with steel components and operating conditions.

Rack & Pinion Operation

Provides a smooth constant control of the door through its full opening and closing cycle. 180° door swing can be achieved when door, frame, hardware and arm function do not limit door swing.

Non-handed

With few exceptions all series 51 door closers are non-handed and can be installed on either right- or left-hand swing doors. Pinion shaft extends vertically through the closer body in both directions. Some options, (such as Parallel Rigid Hold Open Arms) will require that the hand of the closer be specified.

Tri-packed

51 comes with screws, brackets & soffit plate to allow for regular, top jamb, & parallel arm installations.

Sweep Speed Control Valve

Allows adjustment of door's speed from the door's full open position down to approximately 10° from the closed position.

Latch Speed Control Value

Allows adjustment of door speed from approximately 10° down to the door's fully closed position.

Adjustable Backcheck Cushion Valve

Provides control of the door in the opening cycle, beginning at approximately 75° of door opening. It slows/ cushions the door opening, when the door is forcibly opened beyond its pre-adjusted opening speed limits.

Closer Fluid

All door closers are supplied with a temperature stable, multi-viscosity fluid. This fluid will permit the door closer to perform within a wide temperature range: from very high to as low as -40°F.

Warranty

These closers carry a limited 30-year warranty against defects and a limited lifetime warranty on the aluminum housing.

Door Closer Power Options

Series 51 Multi-Sized Door Closer

Fully adjustable through the power range of sizes 1 through 6, as outlined in ANSI/BHMA specification A156.4. Also, complies with the opening force requirements as outlined in the Americans with Disabilities Act (A.D.A.) and ANSI A117.1 for interior doors.

Optional Features

Optional Molded Cover

Molded of high impact U.L. listed material that covers the entire closer body assembly. This cover is non-handed for regular and parallel arm applications. Suffix "P" to catalog number. Not designed for top jamb applications.



Optional Features - Arms

Non-Hold Open

Self-closes door every time door is opened. Auxiliary stop (by others) required.

















Hold Open

Achieved by means of friction or ball and detent/roller. Friction hold open has a range of 90° to 180° using template location and mechanical adjustment. Ball and detent or roller hold open is effective in a range of 85° to 110°.

Hold open arm door closers are not permitted to be used on fire door assemblies.

Finishes



ANSI/BHMA Code Finish Description				
600* Primed for Painting	605^ Bright Brass, Clear Coated	606^ Satin Brass, Clear Coated	611^ Bright Bronze, Clear Coated	612^ Satin Bronze, Clear Coated
				
613 Dark Oxidized Satin Bronze, Oil Rubbed	613E^ Dark Oxidized Satin Bronze - equivalent	625^ Bright Chrome Plated	626^ Satin Chrome Plated	689 Aluminum Painted
				
690 Dark Bronze Painted	691 Light Bronze Painted	693 Black Painted	694 Medium Bronze Painted	696 Satin Brass Painted
				
BSP Black Suede Powder Coat	WSP White Suede Powder Coat			
				

*600 is a special rust-inhibiting prime coat. Closers can be ordered prime coat only (specify closer x 600). An additional charge applies if finish coat is required over prime coat (ex: 51 x 600 x 689).

^ Available on arms only.



How To Order

Ordering Information

Prefix	Function	5	Size	Suffix	X Finish
	Third Digits: Determines arm	5	Fourth Digit: Determines closer size	Suffix: Determines Miscellaneous Features	See page 6
<p>None - Closer installs Regular Arm, Parallel Arm or Top Jamb (reveals) 0" to 2-7/8" (0 to 73mm)</p> <p>TJ - Closer installs Top Jamb only for reveals in excess of 2-3/4" (70mm)</p> <p>PA - Closer installs Parallel Arm only when ordered with the standard soffit bracket or for special installations</p>	<p>None - Standard Non-Hold Open</p> <p>1 - Hold Open Arm</p>	<p>Description: Defines the 51 Series Door Closer</p>	<p>1 - Sizes 1 - 6</p>	<p>BC - Backcheck (standard)</p> <p>P - Cover</p>	

Notes:

- Door closer warranty becomes void if the closer is installed on the exterior side of a door in the exterior wall of a building.
- It is strongly recommended, and may be required on fire door assemblies, that doors having a door closer be hung on ball-bearing or anti-friction hinges or pivots. Consult local authority having jurisdiction.
- Failure to use fasteners supplied with closer may void factory warranty.
- Fasteners for fire/smoke door assemblies must conform to NFPA 80. In some applications additional fasteners may be mandated by NFPA 80 that are not shipped with standard product, such as sleeve-nuts/sex-nuts or thru bolts and grommet nuts.
- Information provided is based on 1-3/4" (44mm) x 7' (2.13m) standard weight doors swinging to 110°. Other conditions (such as door height or weight; or wind/draft conditions) may require adjustment of spring setting, selection of a larger size closer or different closer.

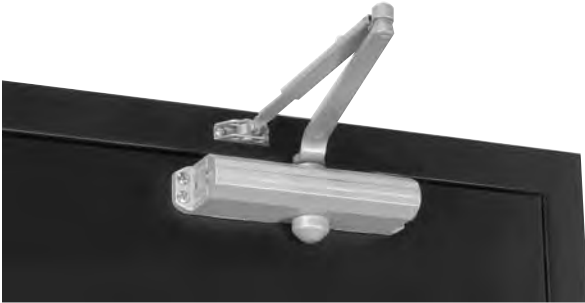

Regular Arm

This is the only pull-side application where a double lever arm is used. It is the most power-efficient application for a door closer. Sufficient frame, door and/or ceiling clearance must be considered. Since the arm assembly projects directly out from the frame, this application may present an aesthetics issue or be prone to vandalism.

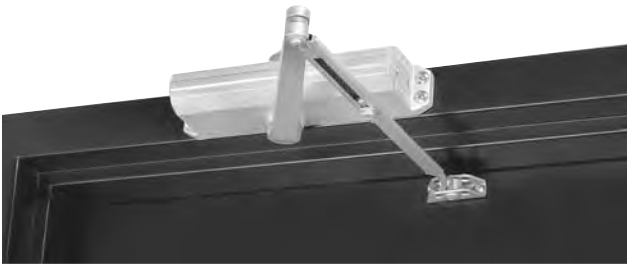

Top Jamb

For efficiency reasons this application provides the best alternative to the regular arm application. There must be sufficient frame face and/or ceiling clearance for this application. It requires a top rail on the door of just 2-1/8" (54mm). This application provides the best door control for doors in exterior walls that swing out of a building. The entire door closer and arm assembly project from the frame, similar to the regular arm application, where the matters of appearance and malicious abuse can be of concern. Consideration must be given to depth of the frame reveal.

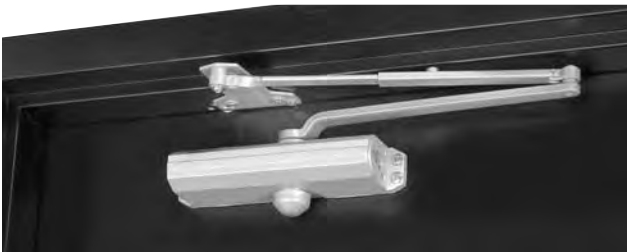

Parallel Arm

This application provides the most appealing design appearance for a surface-mounted door closer having a double lever arm. This may also be beneficial in vandalism-prone areas. It is on the push side of the door and the arm assembly extends almost parallel to the door. In the closed position, there is very little or no hardware projecting beyond the frame face in most situations. Due to the geometry of the arm it is approximately 25% less power-efficient than a regular arm application. The entire closer and arm assembly are mounted below the frame stop, requiring a top rail clearance on the door of between 5-3/8" (137mm), when using a low-profile arm (250 series), to 6-3/8" (162mm), when using the hold open arm.

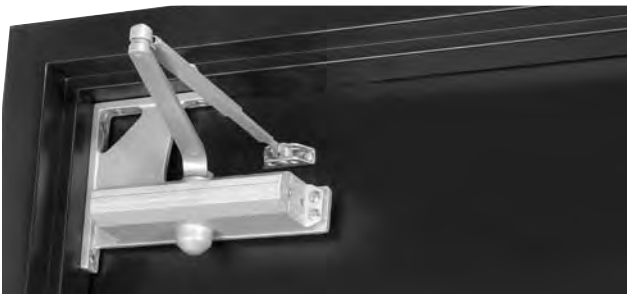

Corner Bracket

This application can be used where top jamb and parallel arm application will not accommodate the door and frame conditions. Requires minimal top rail on the door; however, vertical clearance to the floor within the door opening should be checked to ensure code compliance. The close proximity, for this application, of the door closer to the door's pivot point reduces the door closer's power efficiency by approximately 25% when compared to a regular arm. The projection of the arm from the door face might pose questions regarding design parameters or environment.



Regular Arm

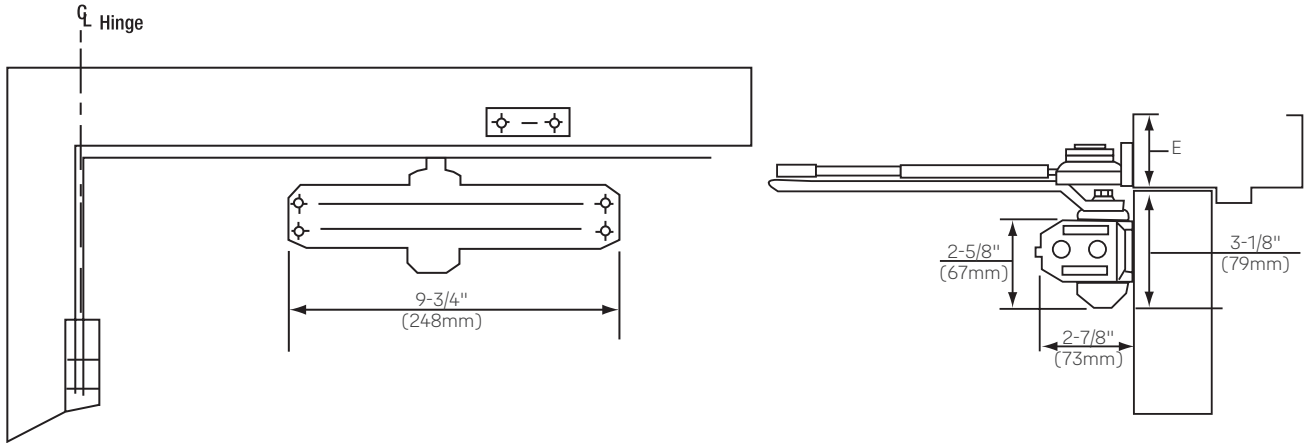

Mounting holes for closer body are spaced $3/4$ " (19mm) vertically x $9-1/16$ " (230mm) horizontally.

Model Number	
Non-Hold Open	Hold Open
51	151

E Minimum Ceiling Clearance Inches (mm)	
Non-Hold Open	Hold Open
1-1/2" (38)	1-5/8" (41)

Standard Door Widths	
Interior	32" - 48" (81-122cm)
Exterior	30" - 48" (76-122cm)

Consult factory if door weight exceeds 250 lbs.



Top Jamb

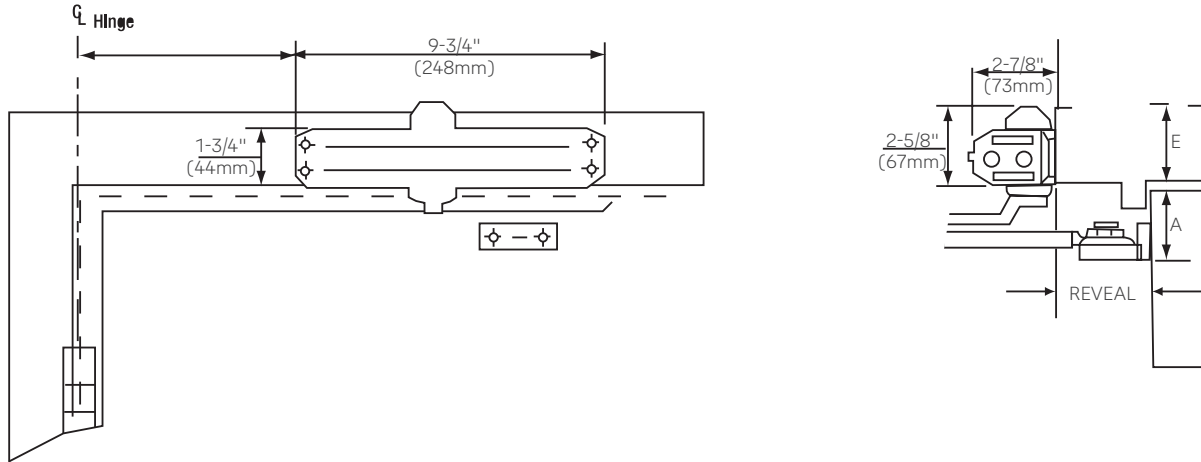

* For doors opening up to 100°
 Mounting holes for closer body are spaced 3/4" (19mm) vertically x 9-1/16" (230mm) horizontally.

Model Number	
Non-Hold Open	Hold Open
51	151

Standard Door Widths	
Interior	32" - 48" (81-122cm)
Exterior	30" - 48" (76-122cm)

Consult factory if door weight exceeds 250 lbs.

E Minimum Ceiling Clearance		A Minimum Top Rail Clearance		
Without Drop Plate	With Drop Plate	Without Drop Plate	With 587 Drop Plate	With 214 Drop Plate
2-5/8" (67)	1-3/4" (44)	1-7/8" (48)	2-5/8" (67)	4" (102)

Closer Series	Reveal Inches (mm)
51	0 to 3" (0 to 76)
TJ51	2-7/8" to 7" (73 to 178)
151	0 to 2-3/4" (0 to 70)
TJ151	2-3/4" to 6-3/4" (70 to 171)



Parallel Arm

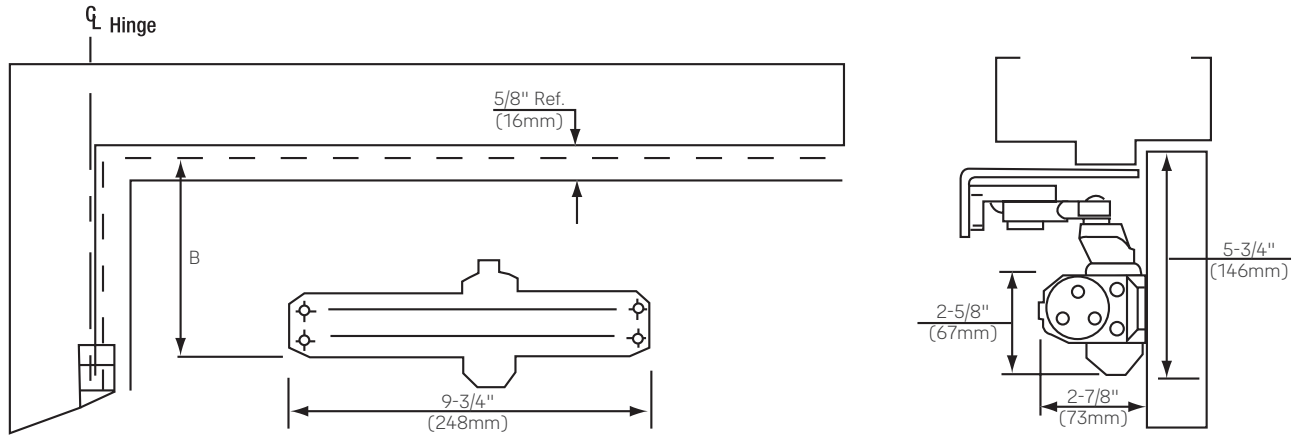

* For doors opening up to 100°
 Mounting holes for closer body are spaced 3/4" (19mm) vertically x 9-1/16" (230mm) horizontally.

Model Number	
Non-Hold Open	Hold Open
51	151

Standard Door Widths	
Interior	30" - 48" (76-122cm)
Exterior	

B Minimum top rail of door with 5/8" (16mm) frame stop	
Without Drop Plate Inches (mm)	With Drop Plate Inches (mm)
5" (127)	3-1/8" (79)

Consult factory if door weight exceeds 250 lbs.



Regular Arm

Brackets for Non-Hold Open Arms

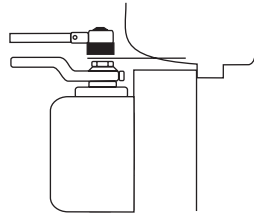
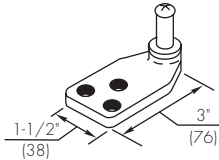

Molded/Bull Nose Trim - 291 Bracket

For use where the door frame has molded or bull nose trim which will not accept a standard non-hold open shoe. The bracket is mortised into the frame rabbet, and projects beyond the face of the frame. It will accommodate a frame rabbet up to 2" (51mm) deep.

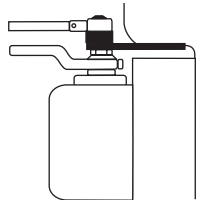
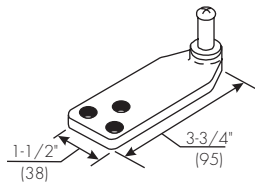

Molded/Bull Nose Trim - 291A Bracket

This bracket is similar to - but longer than - the 291 bracket. It is designed to accommodate frame rabbets from 2" to 2-7/8" (51mm to 73mm) deep.

Brackets for Hold Open Arms

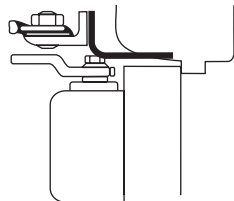
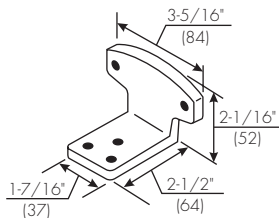

Molded/Bull Nose Trim - 292 Bracket

For use where the door frame has molded or bull nose trim which will not accept a standard hold open shoe. It is mortised into the frame rabbet, and projects beyond the face of the frame. It will accommodate a rabbet up to 2" (51mm) deep. This bracket is used in combination with the standard hold open mounting shoe.

Corner Brackets for Closer Mounting

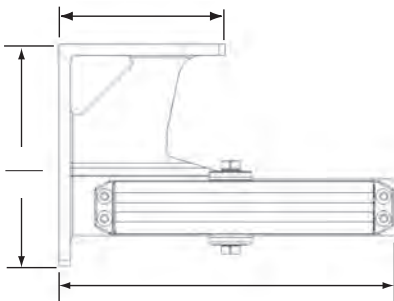

For closer sizing information, use the Parallel Arm sizing chart on page 11.

Mounting Opposite Hinge Side - 2350 Corner Bracket

For use where it is desired to mount the closer regular arm on the opposite to hinge side of the door. Can also be used to clear an overhead door holder.



Top Jamb

Closer Mounting Plates

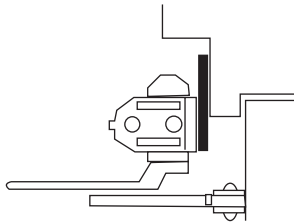
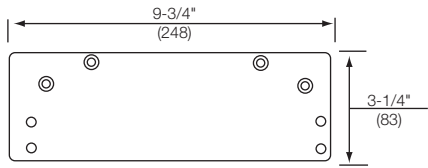

Overhead Door Holder - 214 Drop Plate

For use where an overhead door holder prevents normal top jamb mounting. This places the center line of the arm mounting screws at 3-1/2" (89mm) from the top of the door.

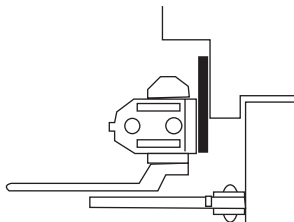
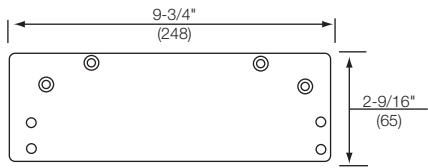

Low Ceiling Clearance - Overhead Door Holder - 587 Drop Plate

For use where the ceiling clearance is between 1-3/4" and 2-5/8" (44mm and 67mm). Or for use where an overhead door holder prevents normal top jamb mounting. This places the centerline of the arm mounting screws at 2-1/8" (54mm) from the top of door.

Parallel Arm

Closer Mounting Plate

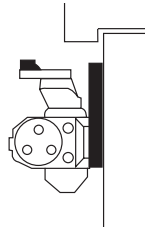
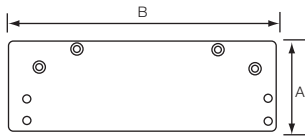

Narrow Top Rail - 214 Drop Plate

For use where a narrow top rail prevents the closer from being mounted directly to the door surface. This drop plate can be used to mount a closer on a top rail as narrow as 3-1/8" (79mm) in height for 50BC or 2-1/8" (54mm) for 50BCP.

Plate No.	Dimensions	
	A (width)	B (length)
214	3-1/4" (83mm)	9-3/4" (248mm)
214C	4-1/8" (105mm)	9-7/8" (251mm)

Note: #214C - To be used when optional cover is specified.

Brackets for Non-Hold Open Arms

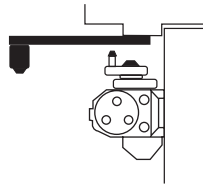
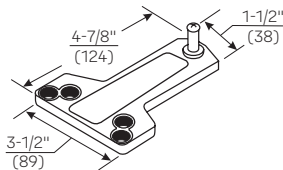

Standard Installation - 289A Soffit Plate

This soffit plate is supplied standard with parallel arm closers. It can be mounted where the frame soffit is as narrow as 1" (25 mm). Specify **289A-SS for stainless steel soffit plate**. With Series PA51S closers, a 289A-SS soffit plate fabricated of stainless steel is supplied standard.

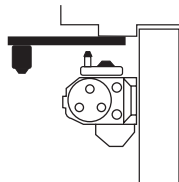
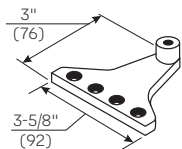

Narrow Frame/Removable Stop - 297 Soffit Plate

For use where a narrow frame or frame with removable stop does not permit use of the standard soffit plate. This soffit plate may be mounted on the frame soffit or the frame rabbet where the stop does not exceed 5/8" (16mm) in height. All of the screw holes are in a straight line, requiring as little as 1-1/4" (32mm) of frame reveal to mount bracket and maintain good closer arm geometry. Where the frame soffit is as wide as 2" (51mm), this soffit plate may be used to clear weather - stripping that is up to 1-3/8" (35mm) wide and 5/8" (16mm) in height.

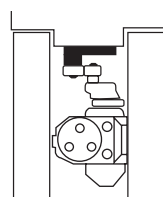
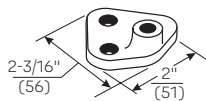

Mounting Between Doors - 413A Soffit Bracket

For use where insufficient space between companion doors does not permit use of other soffit plates. This bracket permits mounting of the closer between doors with as little as 3" (76mm) of header space. Permits closer arm to clear up to 5/8" (16mm) high stop.

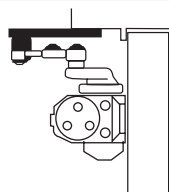
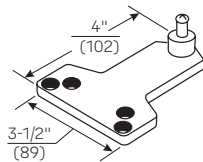

Blade/Applied Stop - 299 Soffit Plate

For use where a blade or applied stop does not permit installation of the standard soffit plate. Mounts to either the frame soffit or rabbet. Since this soffit plate projects 7/8" (22mm) less than a standard soffit plate, it requires a minimum frame reveal of 1-1/2" (38mm). Permits closer to clear up to a 5/8" (16mm) high frame stop.

Parallel Arm

Brackets for Non-Hold Open Arms (Continued)

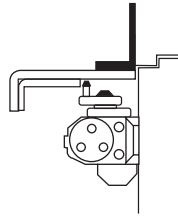
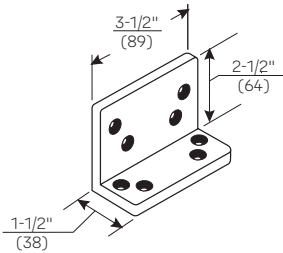

Flush Transom - 589L Angle Bracket

For use where rabbeted or flush transom conditions prevent installation of a soffit plate. Used in combination with the 289A soffit plate, or may be used in combination with the 290 soffit plate when it is necessary for the closer arm to clear a separate overhead door holder.

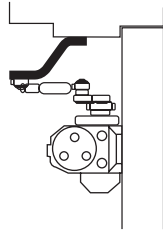
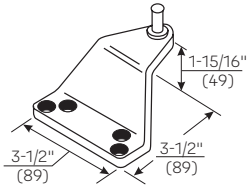

Extra-Clearance - 290 Offset Soffit Plate

For use where the need for additional clearance prevents use of the standard soffit plate. This plate mounts to the frame soffit to provide up to 2" (51mm) of clearance when a separate overhead door holder is used. Standard mounting requires a 2-5/8" (67mm) wide frame soffit. It may also be used where unusually high frame stops or weather-stripping prevent the use of other soffit plates.

Brackets for Hold Open Arms

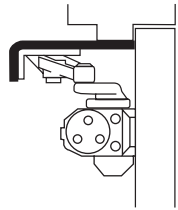
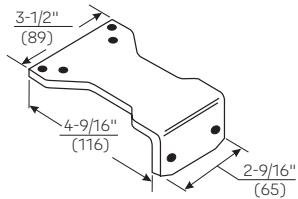

Parallel Hold Open - 588 Adapter Plate

This Adapter Plate is supplied standard with all parallel arm hold open closers. It can also be used to convert regular arm or top jamb hold open arms to parallel arm installation. It can be mounted where the frame soffit is as narrow as 1" (25mm).

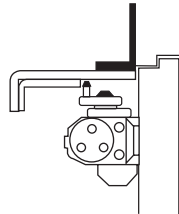
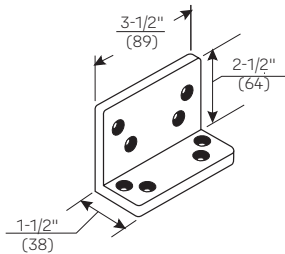

Flush Transom Hold Open - 589L Angle Bracket

For use where rabbeted or flush transom conditions prevent installation of the standard 588 hold open adapter plate. It is used in combination with the 588 adapter plate.



Door Closer Body Assemblies

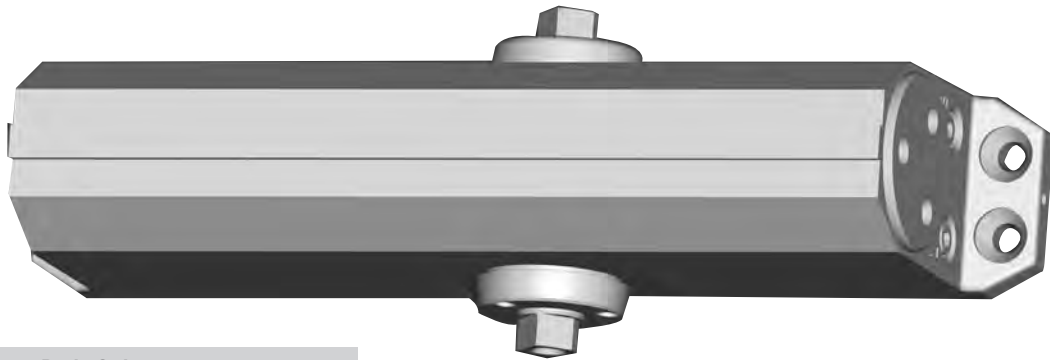

Body Only (Standard)	
51LAP	Multi-sized

LAP = Less All Parts

* Specify closer size. Pinion cap and mounting screws supplied standard.

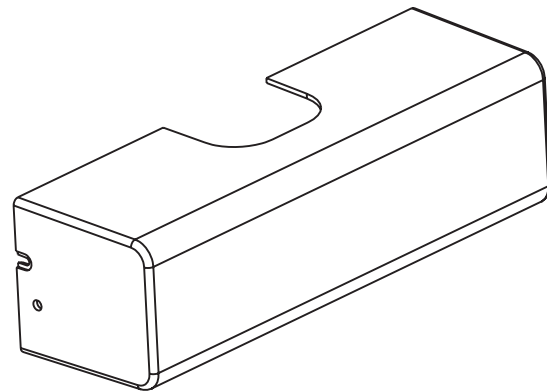

Fasteners

Steel Door Application

Sex Nut / Sleeve-Nut : "SN" (4 per pack) or

Sex Nut / Sleeve-Nut & Screw: "SNB" (4 per pack)

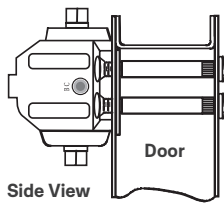

Door	SN's	SNB's
1-3/4"	SN-134	SNB134-38
2"	SN-200	SNB200-38
2-1/4"	SN-214	SNB214-38
S.S. SNB's 1-3/4"	SN-134SS	SNB134SS-38

Cover (optional) - specify 50P

Dimensions (RA and PA applications):

2-7/8" (73mm) height x 3-1/16" (78mm) deep x

9-7/8" (251mm) long

To order with closer use "P" suffix; i.e. 54BCP.

Aluminum and Wood Door Application

(Aluminum Door Shown)

Through-Bolt & Grommet Nut : "TBGN" (4 per pack)

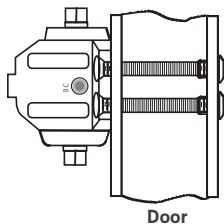

Door	TBGN's
1-3/8"	TBGN138-38
1-3/4"	TBGN134-38
2-1/4"	TBGN214-38

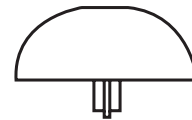

1639 Pinion Cap

Parts List

Non-Hold Open Arm Assemblies

Parallel Arm

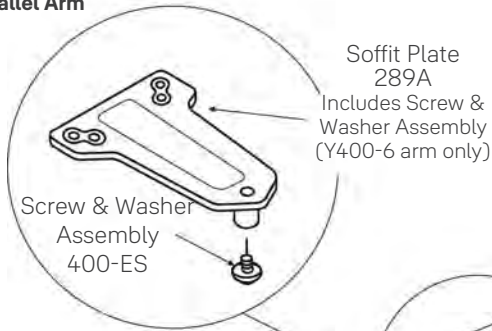

Regular and Top Jamb

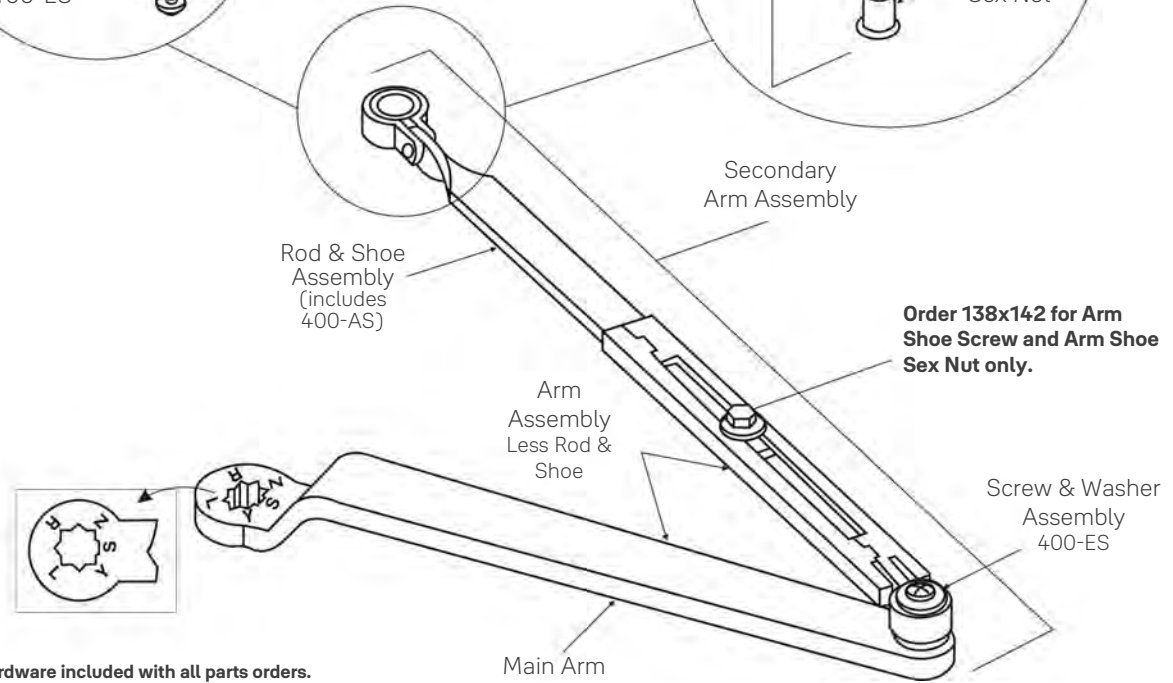
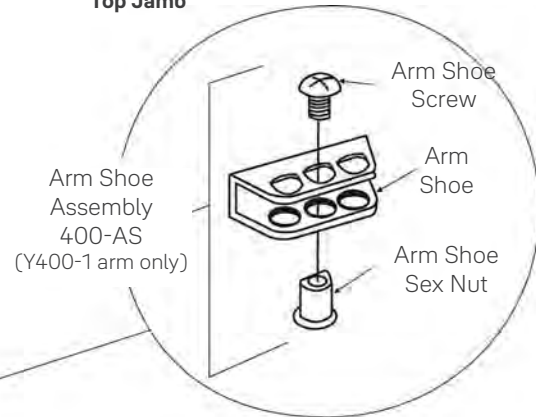

Note: Mounting hardware included with all parts orders.

Closer Series	Complete Arm Assembly	Main Arm Assembly ¹ (length)(mm) (includes 400-ES)	Secondary Arm Assembly (includes 400-ES)	Arm Assembly Less Rod and Shoe	Rod & Shoe Assembly ² (length)(mm)
51	Y400-1	400-1M (11") (279)	Y400-111	Y400-1W	Y400-11 (8-7/8") (225)
TJ51	Y400-1A		Y400-121		Y400-11A (12-1/2") (318)
PA51	Y400-6		Y400-116		Y400-16 (8-7/8") (225)
PA51C ³	Y400-6A		Y400-116A		Y400-16A (12-1/2") (318)
51	Y400-26 (Tri pack includes Y400-1 plus 289A plate)				

1. C/L to C/L length shown in parentheses.

2. C/L of connecting link to end of rod shown in parentheses.

3. For 180° door swing when using a special template for doors hung on 6" to 8" (162mm to 203mm) wide throw hinges.



Hold Open Arm Assemblies

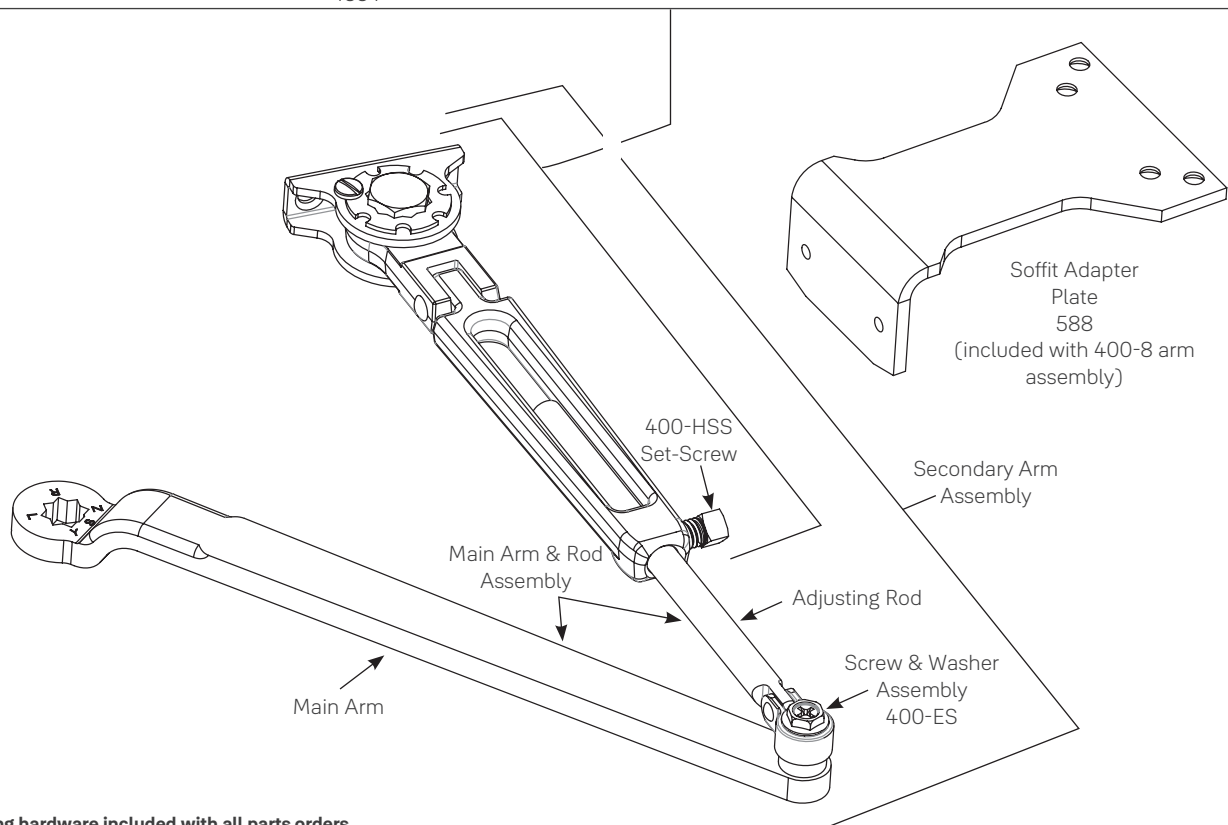
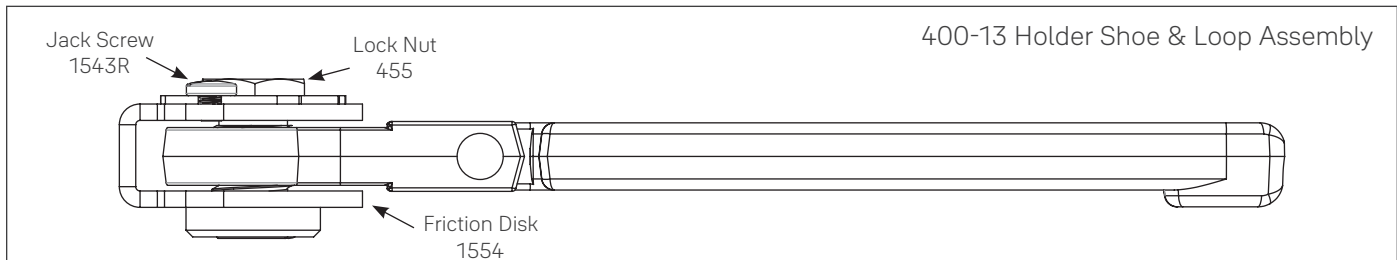

Note: Mounting hardware included with all parts orders.

Closer Series Assembly	Complete Arm Assembly	Main Arm ¹ (Length)(mm) (Includes 400-ES)	Secondary Arm (Includes 400-ES)	Main Arm & Rod Assembly	Holder Shoe & Loop Assembly	Adjusting Rod ² (Length)(mm)
151	400-3/400-8 ³ (Reg)/(Par)	400-1M (11") (279)	400-113/400-118 (Reg)/(Par)	400-3W	400-13 / 400-18 ⁴ (Reg)/(Par)	400-31 (7-3/8") (187)
TJ151	400-3A		400-123	400-3WA		400-31A (10-13/16") (275)

400-18 = Holder Shoe & Loop Assembly (400-13) with soffit adapter plate (588)

1. C/L to C/L length shown in parentheses.
2. C/L of connecting link to end of rod shown in parentheses.
3. Same as 400-3 but includes #588 soffit adapter plate.
4. Same as 400-13 but includes #588 soffit adapter plate.

Sample Specification



51 Series

Closers for interior and exterior doors shall be full rack-and-pinion type with cast aluminum alloy shell. Closers shall be surface mounted and shall project no more than 2-7/8" from the surface of the door. Closers shall be non-handed to permit installation on doors of either hand. Closer fluid shall contain lubricity and anti-oxidation agents. Closer fluid shall maintain stable viscosity to allow the door closer to perform in temperatures ranging from extremely high to as low as - 40°F. Closers shall have multi-size spring power adjustment to permit setting of spring power for sizes (1 through 6). Closers shall have two non-critical valves, hex key adjusted, to independently regulate sweep and latch speed. (Closers shall have adjustable backcheck cushioning controlled by a hex key adjusted valve.) Closer power shall be adjustable using 1/8" hex key.

(Closers shall be provided with a full molded cover.)

Regular arm and top jamb closers shall have a non-hold open shoe permitting 15% (+/- 7-1/2%) power adjustment. [51]



Trusted every day

Customer Service Phone:

1-800-438-1951

Customer Service Fax:

1-800-338-0965

24/7 Support Phone:

1-855-213-5841

24/7 Support Email:

Support@YaleLock.com

Website:

yalecommercial.com

Email for orders:

orders.yaleus@assaabloy.com

Contact Us

U.S.A.

Yale Locks & Hardware

Address: 225 Episcopal Road

Berlin, CT 06037-4004

Tel: 1-800-438-1951

Fax: 1-800-338-0965

yalecommercial.com

Canada:

ASSA ABLOY Door Security Solutions Canada

Address: 160 Four Valley Drive

Vaughan, Ontario L4K 4T9

Tel: 1-800-461-3007

Fax: 1-800-461-8989

assaabloydss.ca

International:

ASSA ABLOY Americas International

Tel: 1-905-821-7775

Fax: 1-905-821-1429

assaabloyai.com

THE YALE BRAND, with its unparalleled global reach and range of products, reassures more people in more countries than any other consumer locking solution.

THE ASSA ABLOY GROUP is the world's leading manufacturer and supplier of locking solutions, dedicated to satisfying end-user needs for security, safety and convenience.

Yale Commercial is a business associated with ASSA ABLOY Access and Egress Hardware Group, Inc., an ASSA ABLOY Group company. Copyright © 2001-2021, ASSA ABLOY Access and Egress Hardware Group, Inc. All rights reserved. Reproduction in whole or in part without the express written permission of ASSA ABLOY Access and Egress Hardware Group, Inc. is prohibited. Patent pending and/or patent www.assaabloydss.com/patents.



1100 Series Industrial Door Closers





Contents

Introduction	2
Features & Benefits	3
Certifications	4
Door Closing Latching Cycle	4
How To Order and Finishes	5
Applications	6
Dimensions	7
Parts List	7

1100 Series Door Closer

The Yale® 1100 series industrial door closers are ideal for a wide variety of commercial applications where ease of use and installation are required at an economic price.

The 1100 series features rugged construction, adjustments for closing and latch speed, and rack and pinion operation.

Bringing you a dependable door closer at an attractive price point. Yale Works for YouSM.

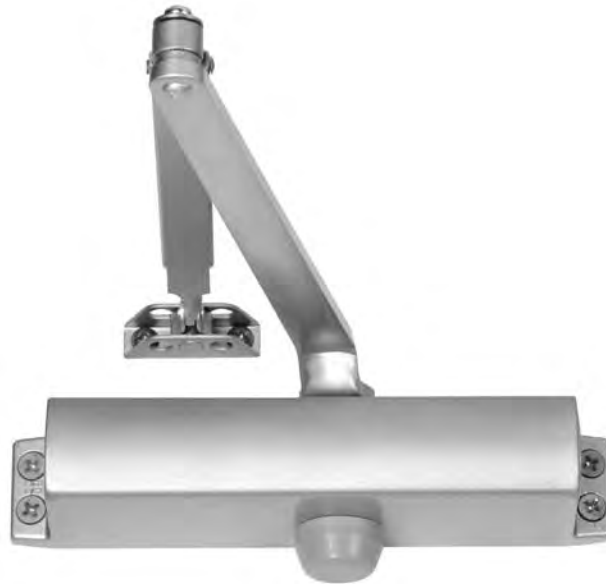

Features

- 1101BF (non-hold open) and 1111BF (hold open) door closers are adjustable spring sizes 1 through 4
- 1104BC (non-hold open) door closers are spring size 4
- Non-handed
- Full rack and pinion
- Aluminum body
- Tri-packed: regular, parallel or top jamb mounting
- Adjustable backcheck valve
- Adjustable closing speed valve
- Adjustable latching speed valve
- Auxiliary door stop required
- Sleeve nuts included with all models (1-3/4")
- 5-year limited warranty
- 1101BF closers available with or without cover

Benefits

- **Accessible:** Tri-packed closer allows installation of multiple applications
- **Economical:** 5-year limited warranty; Longer life results in fewer replacements and less material used
- **Customizable:** Non-handed for right or left hand installation; Adjustable 1-4 or size 4 models available

Overview



Certifications

- ANSI/BHMA A156.4, Grade 1
- UL and cUL listed. This includes compliance to UL10C.
- BF door closers meet handicapped requirements for light to medium weight interior doors.

CAUTION: Door Closers for Low Opening Force Applications:

Door closers installed in openings required to meet the requirements of the Americans With Disabilities Act or ANSI/BHMA Standard A117.1, when adjusted to meet those requirements, may not provide adequate closing power to dependably close and latch the door based on opening or site conditions.

Door Closing Latching Cycle

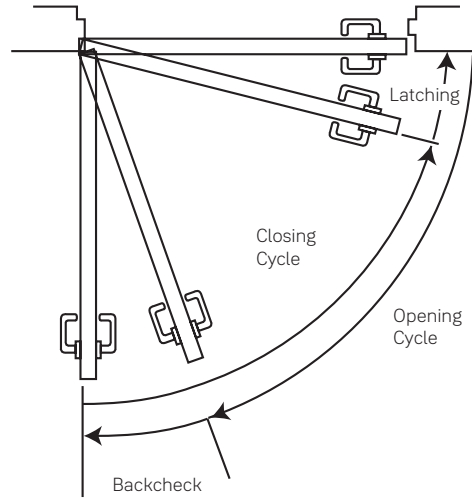



How To Order



Model #	Description	Finish
1101BF	Multi-sized Closer - Non-Hold Open	689 690 BSP
1101BFxCOV	Multi-sized Closer - Non-Hold Open with Cover	
1104BC	Size 4 Closer with Backcheck - Non-Hold Open	
1111BF	Multi-sized Closer - Hold Open	

Sleeve Nuts furnished standard with all models.

NOTE:

- Door closer warranty becomes void if the closer is installed on the exterior side of a door in the exterior wall of a building.
- It is strongly recommended, and may be required on fire door assemblies, that doors having a door closer be hung on ball-bearing or anti-friction hinges or pivots. Consult local authority having jurisdiction.
- Failure to use fasteners supplied with closer may void factory warranty.
- Fasteners for fire/smoke door assemblies must conform to NFPA 80. In some applications additional fasteners may be mandated by NFPA 80 that are not shipped with standard Yale product, such as sleeve-nuts/sex-nuts or thru bolts and grommet nuts.
- Information provided is based on 1-3/4" (44mm) x 7' (2.13m) standard weight doors swinging to 110°. Other conditions (such as door height or weight; or wind/draft conditions) may require adjustment of spring setting, selection of a larger size closer or different closer.

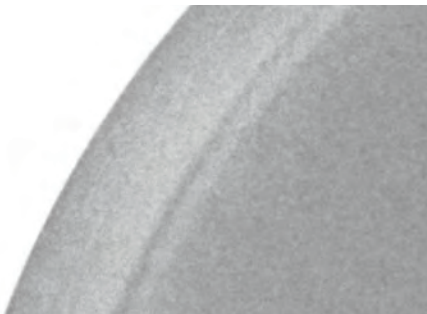
Finishes

ANSI/BHMA Code Finish Description		
689 Aluminim Painted	690 Dark Bronze Painted	BSP Black Suede Powder Coat
		

Applications



Regular Arm



Top Jamb



Parallel Arm

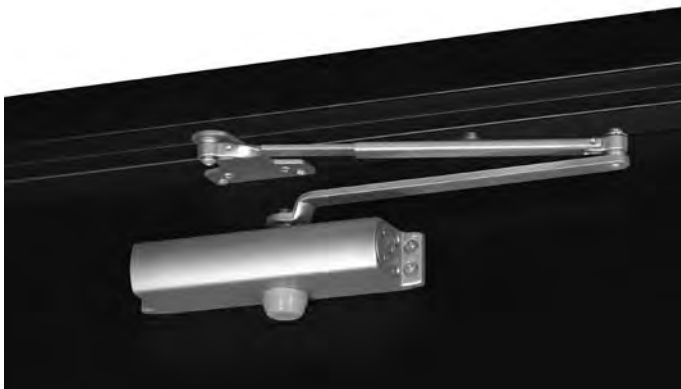

Consult factory if door weight exceeds 175 lbs.



Dimensions

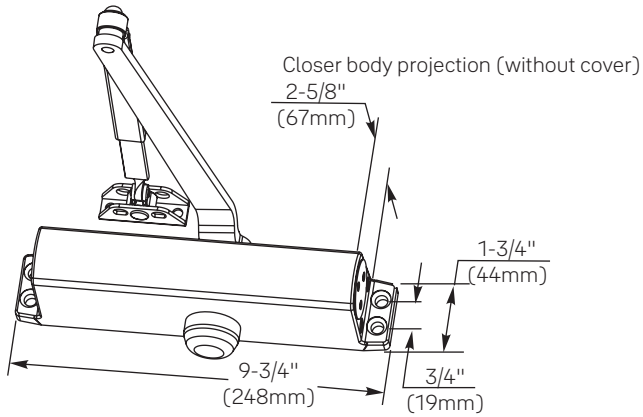

Parts List

Description	Part Number*
Sleeve Nuts (1-3/4" door only)	SN-134
Cover (order by part number)	1100COV

*Specify finish when ordering



Trusted every day

Customer Service Phone:

1-800-438-1951

Customer Service Fax:

1-800-338-0965

24/7 Support Phone:

1-855-213-5841

24/7 Support Email:

Support@YaleLock.com

Website:

yalecommercial.com

Email for orders:

orders.yaleus@assaabloy.com

Contact Us

U.S.A.

Yale Locks & Hardware

Address: 225 Episcopal Road

Berlin, CT 06037-4004

Tel: 1-800-438-1951

Fax: 1-800-338-0965

yalecommercial.com

Canada:

ASSA ABLOY Door Security Solutions Canada

Address: 160 Four Valley Drive

Vaughan, Ontario L4K 4T9

Tel: 1-800-461-3007

Fax: 1-800-461-8989

assaabloydss.ca

International:

ASSA ABLOY Americas International

Tel: 1-905-821-7775

Fax: 1-905-821-1429

assaabloyai.com

THE YALE BRAND, with its unparalleled global reach and range of products, reassures more people in more countries than any other consumer locking solution.

THE ASSA ABLOY GROUP is the world's leading manufacturer and supplier of locking solutions, dedicated to satisfying end-user needs for security, safety and convenience.

Yale Commercial is a business associated with ASSA ABLOY Access and Egress Hardware Group, Inc., an ASSA ABLOY Group company. Copyright © 2017-2020, ASSA ABLOY Access and Egress Hardware Group, Inc. All rights reserved. Reproduction in whole or in part without the express written permission of ASSA ABLOY Access and Egress Hardware Group, Inc. is prohibited. Patent pending and/or patent www.assaabloydss.com/patents.



1900 Series Traditional Door Closers





Contents

Introduction	2
Features & Benefits.....	3-4
Finishes	5
How to Order	6
Applications	7-8
Technical Details	9-12
Accessories.....	13-18
Parts List	19-23
Specifications.....	24

1900 Series Door Closer

The Yale® 1900 Series Traditional Surface Closer offers conventional closer styling in combination with contemporary closer control and the installation convenience of a one-size closer shell. Only two spring sizes are required to provide control for the complete range of door sizes. The 1900 Series Door Closers are designed for traditional and period decor while at the same time meeting the strict requirements of engineers worldwide.

The Yale® 1900 Series Traditional Closers are available for standard arm, parallel arm or corner bracket installation. Rigid heavy-duty non-hold open and hold open arms are available for Parallel Rigid and UNI Stop™ Parallel arm installations. A variety of accessories is available to meet most installation requirements. Yale Works for YouSM.

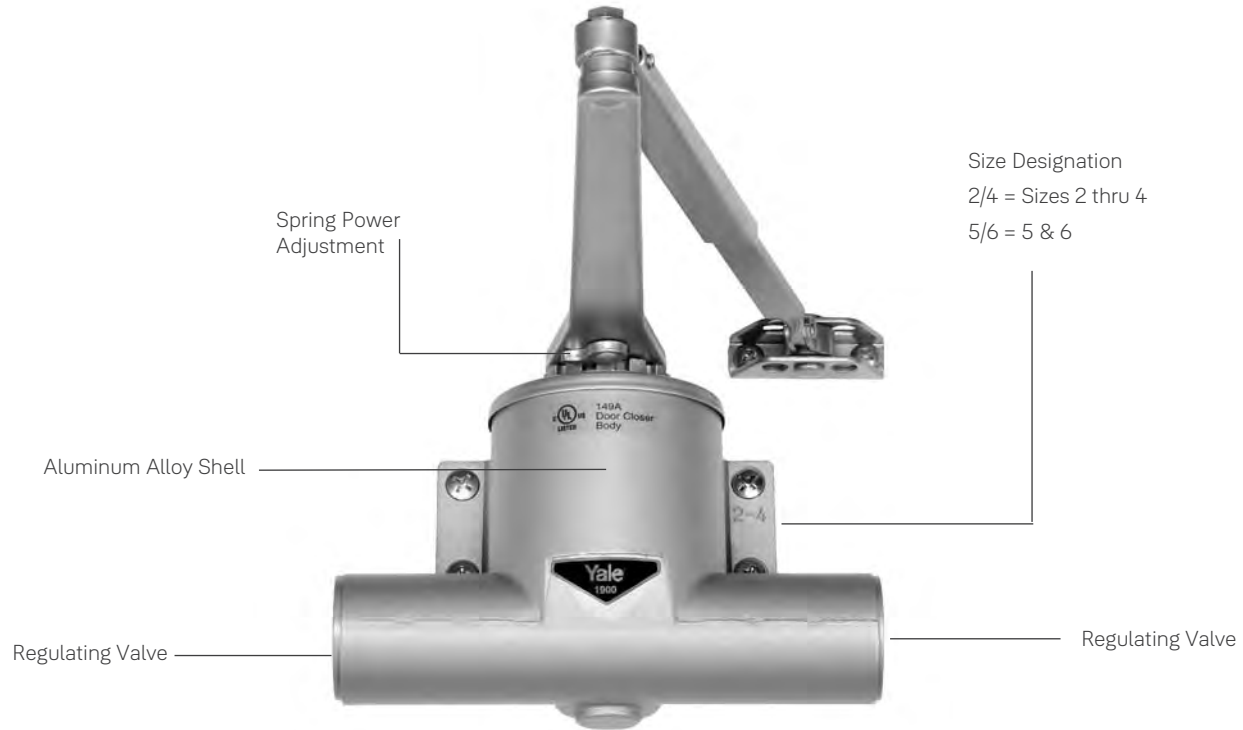

Standard Features

- Choice of adjustable spring power. Models 1902/4, 1912/4 are sizes 2, 3 or 4. Models 1905/6, 1915/6 are sizes 5 and 6
- Heavy-duty arms available
- Handed (closer spring can be reversed in field; recommend ordering correct handing when possible)

Benefits

- **Customizable:** Available with standard or heavy duty arms to meet installation requirements
- **Convenient:** One-size closer shell; Only two spring sizes needed to provide control for all door sizes
- **Compliant:** All closers with non-hold open arms are UL listed for labeled fire doors; UL10C compliant

Compliance Standards

- UL/cUL listed for use on fire rated doors 
- UL10c listed for positive pressure fire test
- This product is manufactured in an ISO 9001, ISO 14001 facility.



One-Size Aluminum Housing

Closer is housed in special aluminum alloy shell selected for its ability to provide optimum performance. One body size provides simplified templating and installation.

Adjustable Spring Power

Clock-type coil spring allows incremental adjustment of closer power to meet individual installation needs. Permits a fine adjustment of the closer to the environment.

Rack and Pinion Design

Provides a smooth constant control of the door through its full opening and closing cycle.

Adjustable Closing Speed/Latch Speed

A dual-purpose regulating valve, hex-key operated, permits independent adjustment of both sweep and latch speed.

Adjustable Backcheck Cushioning

An independent regulating valve, hex-key-operated, provides an adjustable hydraulic cushion to the door opening speed toward the end of the opening cycle. This feature is standard with all but delayed action closers. Backcheck is not available with delayed action closers.

Non-Hold Open Arm

Standard closer will be supplied with a non-hold open arm. This arm is non-handed.

Adjustable Power Standard Installation Jamb Bracket

Provides a $\pm 7\text{-}1/2\%$ power adjustment by relocation of the forearm pin in the jamb bracket. Supplied standard with all standard installation and corner bracket installation non-hold open closers.

Hold Open Arm

Available with heavy-duty arms (Parallel Rigid and UNI Stop)

Field Reversible

Closer spring can be reversed to accommodate the hand of the door. It is recommended that wherever possible the closer be ordered handed. Parallel hold open arms and delayed action closers are not reversible.

Adjustable Delayed Action Closing

Closer's initial closing speed at the beginning of the closing cycle (from full open down to approximately 70°) is adjustable, allowing slow-moving traffic to pass through the opening before the closer begins its normal closing speed. For regular arm non-hold open closers only. Delayed action closers are not available with backcheck cushioning. Delayed action closers are handed.

Optional Features

Adjustable Delayed Action Closing*

(Supplied in lieu of backcheck feature) An optional hydraulic feature that adds a third speed range to the closing cycle. This feature becomes effective when the door is opened and released at any point beyond 70°. The amount of time delay depends upon the combination of the angle of door release and valve adjustment. The valve can be adjusted with a 1/8" (3mm) hex key from no delay time up to maximum delay times of:

Suggested Applications

Delayed action closing allows slow-moving traffic to clear the opening before the door closer's normal closing cycle begins. This feature can be helpful in health care facilities such as hospitals and nursing homes. It provides sufficient time for persons on crutches or in wheelchairs to pass through a door without concern of it closing. At the same time, it can accommodate the facility's staff with movement of food service carts, beds, and other wheeled traffic. Use of delayed action closers on many doors throughout industrial and commercial buildings can also assist the flow of traffic. Locations where additional time to clear the opening is advantageous are doors between office and factory/warehouse facilities, doors to workshops or laboratories, to kitchen and food processing areas, etc.

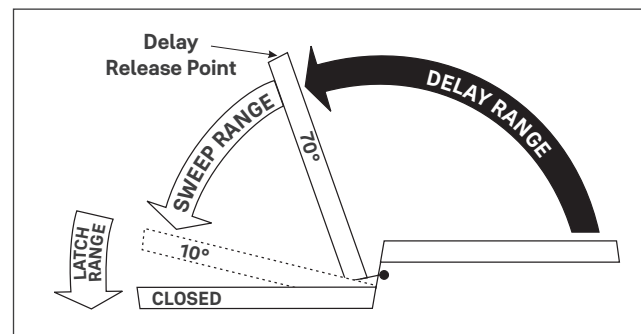







Door Opened and Released at	Approximate Time of Delay Cycle
180°	4-5 minutes
120°	2-3 minutes
90°	25-30 seconds

*Note: Regular arm (NHO units only) are handed - not reversible

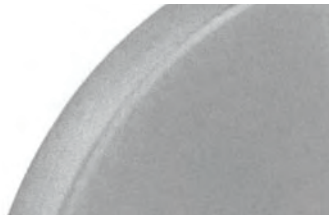
Finishes



Product will be painted with a combination of waterborne acrylic and polyester powder coat. Closers will withstand 100 hours of salt spray. (The ANSI requirement is 25 hours.)

ANSI/BHMA Code Finish Description			
600* Primed for Painting	689 Aluminum Painted	690 Dark Bronze Painted	691 Light Bronze Painted
			
693 Black Painted	694 Medium Bronze Painted	696 Satin Brass Painted	
			

*600 is a special rust-inhibiting prime coat. Closers can be ordered prime coat only (specify closer x 600). An additional charge applies if finish coat is required over prime coat (ex: 1902/4 x 600 x 689).

How To Order

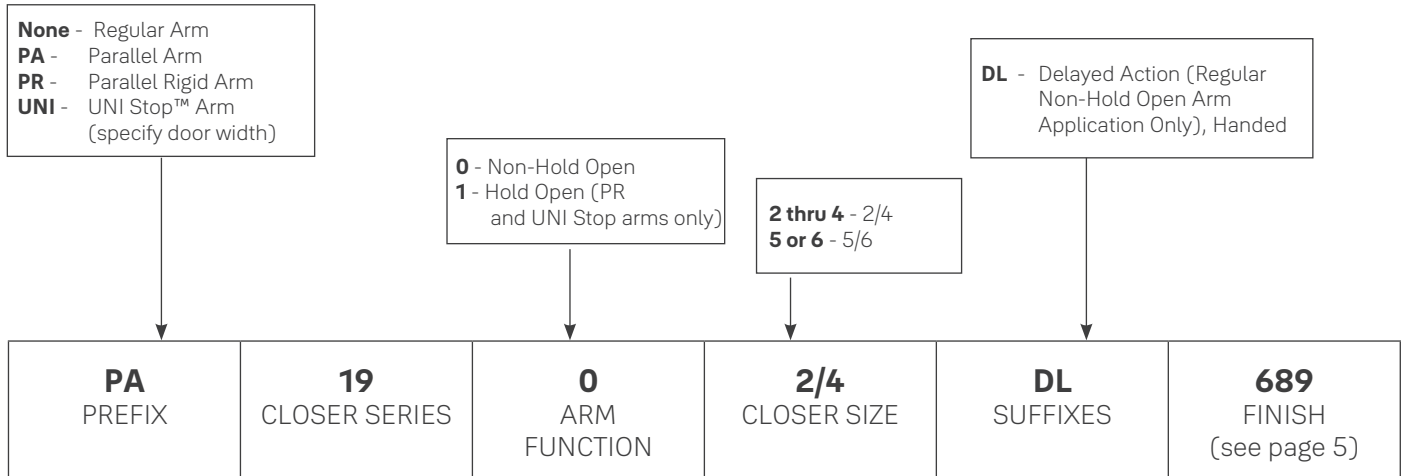

- NOTE:
- Door closer warranty becomes void if the closer is installed on the exterior side of a door in the exterior wall of a building.
 - It is strongly recommended, and may be required on fire door assemblies, that doors having a door closer be hung on ball-bearing or anti-friction hinges or pivots. Consult local authority having jurisdiction.
 - Failure to use fasteners supplied with closer may void factory warranty.
 - Fasteners for fire/smoke door assemblies must conform to NFPA 80. In some applications additional fasteners may be mandated by NFPA 80 that are not shipped with standard Yale product, such as sleeve-nuts/sex-nuts or thru bolts and grommet nuts.
 - Information provided is based on 1-3/4" (44mm) x 7' (2.13m) standard weight doors swinging to 110°. Other conditions (such as door height or weight; or wind/draft conditions) may require adjustment of spring setting, selection of a larger size closer or different closer.



Regular Arm

This is the only pull-side application where a double lever arm is used. It is the most power-efficient application for a door closer. Sufficient frame, door and/or ceiling clearance must be considered. Since the arm assembly projects directly out from the frame, this application may present an aesthetics issue or be prone to vandalism.

Only available with non-hold open arm.



Parallel Arm

This application provides the most appealing design appearance for a surface-mounted door closer having a double lever arm. This also makes it beneficial in vandalism-prone areas. It is on the push side of the door and the arm assembly extends almost parallel to the door. In the closed position, there is very little or no hardware projecting beyond the frame face in most situations.

Due to the geometry of the arm it is approximately 25% less power-efficient than a regular arm application.

The entire closer and arm assembly are mounted below the frame stop, requiring a top rail of 5-3/8" (137mm) to mount the body. Clearance to the bottom of the closer body from the top of the door is 7-3/8" (187mm). (Based on a 5/8" (16mm) high frame stop.)

Only available with non-hold open arm.



Parallel Rigid Arm

An enhanced variation of the standard parallel arm assembly that is intended for use in heavy traffic areas where auxiliary door stops are installed. Hold open available - specify hand when ordering.

UNI Stop™ Arm (Parallel Arm applications only)

UNI Stop™ arms combine the features of a double-lever arm overhead door stop/holder with the backcheck feature of the door closer to reduce door stopping shock loads to a minimum. The UNI Stop arm uses a compression spring buffer at the soffit plate/arm shoe that will absorb 30 lbs. of force, 5° prior to the door's dead stop. Coupled with the door closer's backcheck feature, this arm provides the most controlled stop available with a surface door closer.

There are three different length arm assemblies. Each length is designed for a specific range of door widths to provide precise door control. This further lessens the dead stop impact on the door's hinges/pivots.



Regular Arm Installation

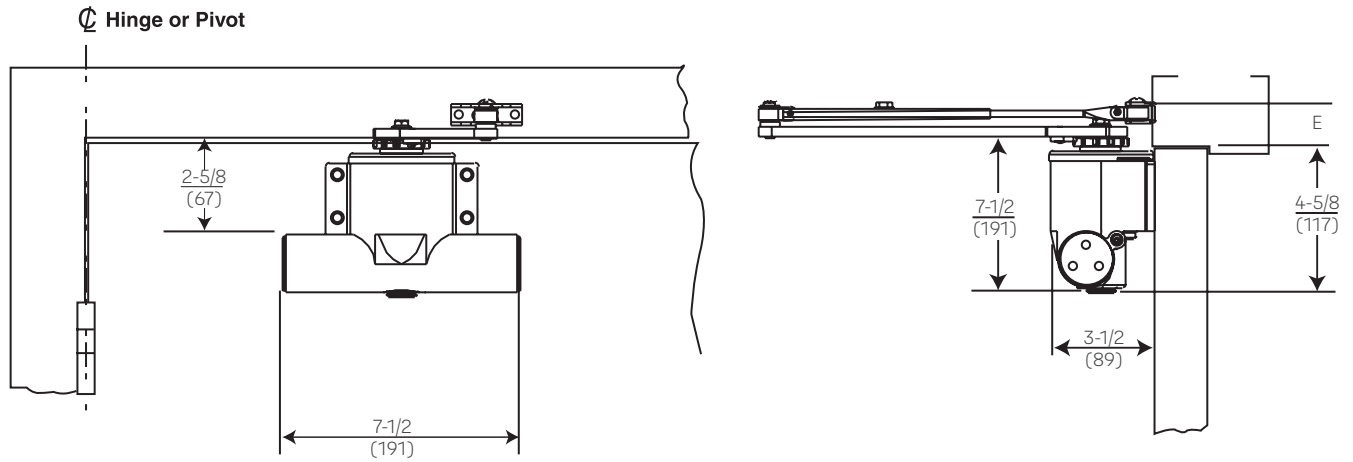

Body mounting holes are spaced 4-1/8" (105mm) horizontally and 1-3/8" (76mm) vertically.

Maximum Door Size Wood or Metal Inches (cm)		Model Number	E Minimum Ceiling Clearance Inches (mm)
Interior	Exterior	Non-Hold Open	Non-Hold Open
48" (122)	36" (91)	1902/4	1-1/2" (38)
—	44" (112)	1905/6	

Dimensions are given in inches (mm) unless otherwise noted. All dimensions are for reference only.

Note: Consult factory if door weight exceeds 175 lbs.

Parallel Arm Installation

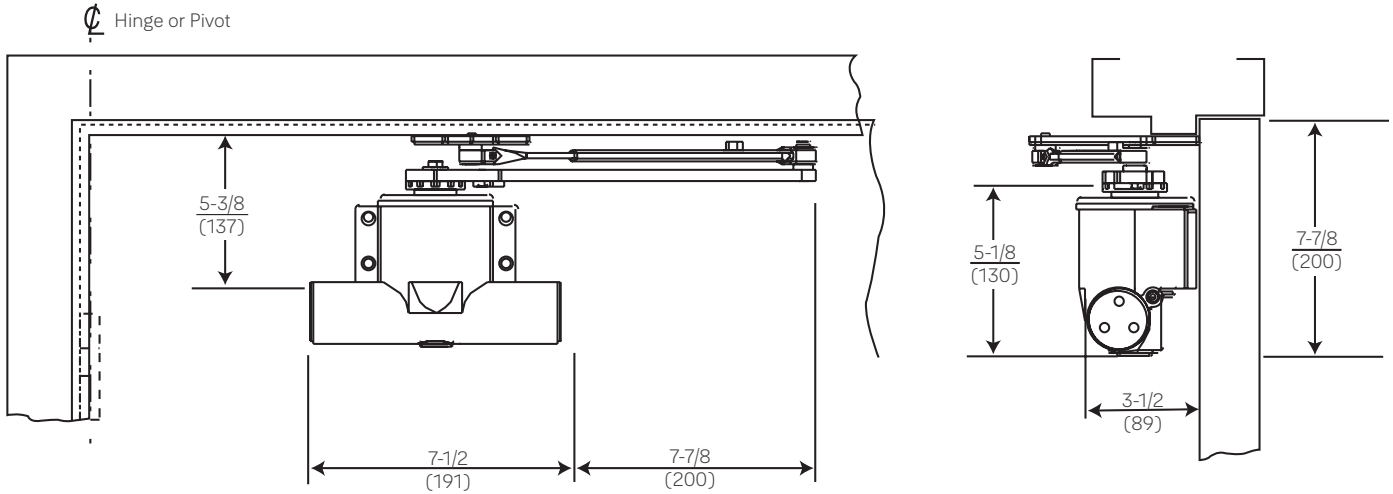

Body mounting holes are spaced 4-1/8" (105mm) horizontally and 1-3/8" (76mm) vertically.

Maximum Door Size Wood or Metal Inches (cm)		Model Number
Interior	Exterior	Non-Hold Open
42" (107)	36" (91)	PA1902/4
—	44" (112)	PA1905/6

All dimensions are for reference only. Dimensions are given in inches (mm) unless otherwise noted.

Note: Consult factory if door weight exceeds 175 lbs.

Parallel Rigid Arm

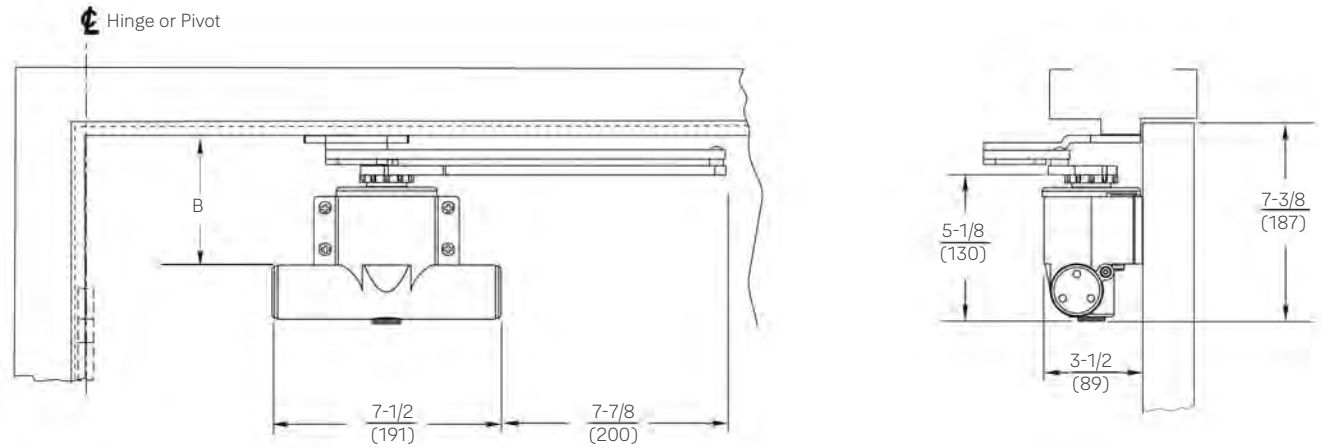

Body mounting holes are spaced 4-1/8" (105mm) horizontally and 1-3/8" (76mm) vertically.

Maximum Door Size Wood or Metal Inches (cm)		Model Number		B Minimum Top Rail with 5/8" (16mm) frame stop	
Interior	Exterior	Non-Hold Open	Hold Open	Without Drop Plate	With 1988 Drop Plate
48" (122)	36" (91)	PR1902/4	PR1912/4	5-3/8" (137)	2-1/2" (64)
—	44" (112)	PR1905/6	PR1915/6		

All dimensions are for reference only. Dimensions are given in inches (mm) unless otherwise noted.

Note: Consult factory if door weight exceeds 175 lbs.

UNI™ Stop Arm

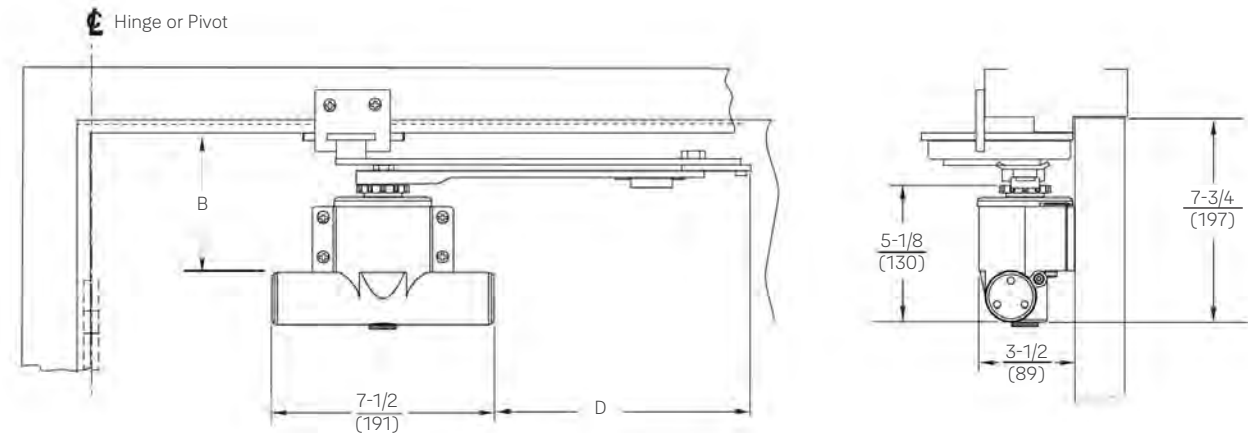

Body mounting holes are spaced 4-1/8" (105mm) horizontally and 1-3/8" (76mm) vertically.

Door Width Inches (cm)	B Minimum Top Rail 5/8" (16mm) Frame Stop		D Arm Extension Beyond Closer
	Without Drop Plate	With 1988 Drop Plate	
28-32" (71-81)	5-5/8" (143)	2-3/4" (70)	8-7/8" (225)
33-41" (84-104)			10-3/8" (264)
42-48" (107-122)			11-7/8" (302)

Maximum Door Size Inches (cm)		Model Number		
Interior	Exterior	Non-Hold Open	Hold Open	x Specify Door Width
28-41" (71-104)	28-36" (71-91)	UNI1902/4	UNI1912/4	
42-48" (107-122)	37-48" (94-122)	UNI1905/6	UNI1915/6	

All dimensions are for reference only. Dimensions are given in inches (mm) unless otherwise noted.

Note: Consult factory if door weight exceeds 175 lbs.



Regular Arm

Brackets For Non-Hold Open Arms

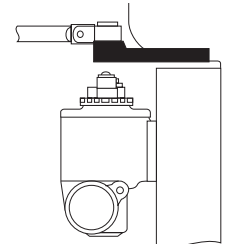
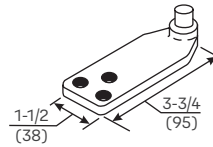
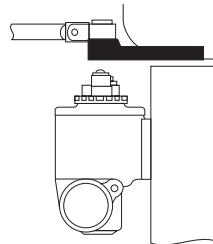
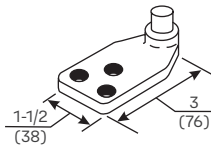

Molded/Bull Nose Trim - 291 Bracket:

For use where the door frame has molded or bull nose trim which will not accept a standard non-hold open shoe. The bracket is mortised into the frame rabbet and projects beyond the face of the frame. It will accommodate a frame rabbet up to 2" (51 mm) deep.

Molded/Bull Nose Trim - 291A Bracket:

This bracket is similar to - but longer than - the 291 bracket. It is designed to accommodate frame rabbets from 2" to 2-7/8" (51 to 73mm) deep.

Bracket For Hold Open Arms

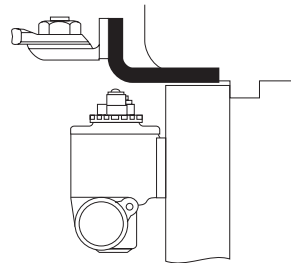
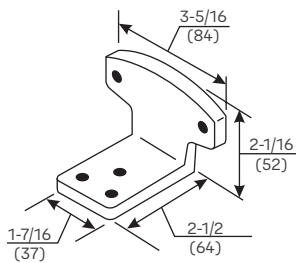

Molded/Bull Nose Trim - 292 Bracket: For use where the door frame has molded or bull nose trim which will not accept a standard hold open shoe. It is mortised into the frame rabbet, and projects beyond the face of the frame. It will accommodate a rabbet up to 2" (51mm) deep. This bracket is used in combination with the standard hold open mounting shoe.



Brackets For Non-Hold Open Arms

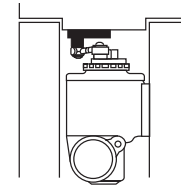
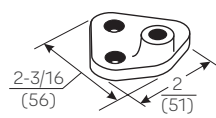
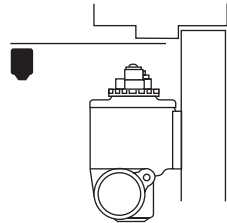
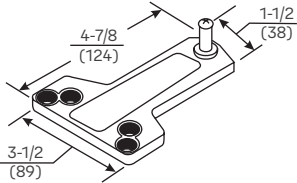

Standard Installation - 289 Soffit Plate:

This soffit plate is supplied standard with parallel arm closers. It can be mounted where the frame soffit is as narrow as 1" (25mm).

Mounting Between Doors - 413A Soffit Bracket: For use where insufficient space between companion doors does not permit use of other soffit plates. This bracket permits mounting of the closer between doors with as little as 4-1/8" (105mm) of header space. Permits closer arm to clear up to a 5/8" (16mm) high stop.

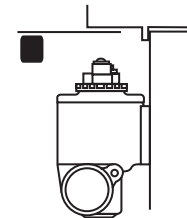
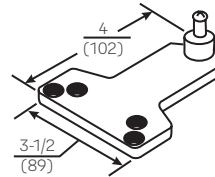
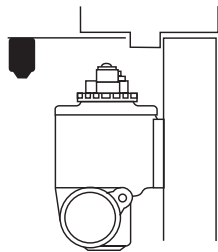
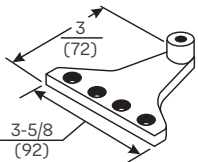

Narrow Frame/Removable Stop - 297 Soffit Plate: For use where a narrow frame or frame with removable stop does not permit use of the standard soffit plate. This plate may be mounted on the frame soffit or the frame rabbet where the stop does not exceed 5/8" (16mm) in height. All of the screw holes are in a straight line, requiring as little as 1-1/4" (32mm) of frame reveal to mount bracket and maintain good closer arm geometry. Where the frame soffit is as wide as 2" (51mm), this soffit plate may be used to clear weatherstripping that is up to 1-3/8" (35mm) wide and 5/8" (16mm) in height.

Blade/Applied Stop - 299 Soffit Plate: For use where a blade or applied stop does not permit installation of the standard soffit plate. Mounts to either the frame soffit or rabbet. Since this soffit plate projects 7/8" (22mm) less than a standard soffit plate, it requires a minimum frame reveal of 1-1/2" (38mm). Permits closer arm to clear up to a 5/8" (16mm) high stop.

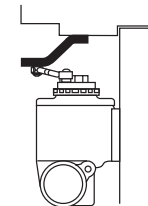
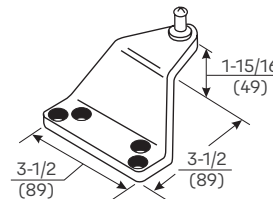
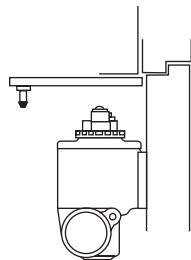
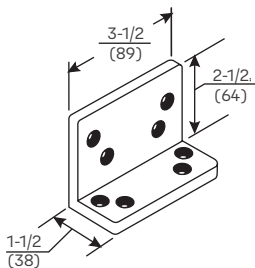

Flush Transom - 589L Angle Bracket: For use where rabbeted or flush transom conditions prevent installation of a soffit plate. Used in combination with the 289 soffit plate, or it may be used in combination with the 290 soffit plate when it is necessary for the closer arm to clear a separate overhead door holder.

Extra-Clearance - 290 Offset Soffit Plate: For use where the need for additional clearance prevents use of the standard soffit plate. This plate mounts to the frame soffit to provide up to 1-1/2" (38mm) of clearance when a separate overhead door holder is used. Standard mounting requires a 2-5/8" (67mm) wide frame soffit. It may also be used where unusually high frame stops or weatherstripping prevents the use of other soffit plates.

Parallel Rigid Arm

Brackets For Non-Hold Open And Hold Open Arms

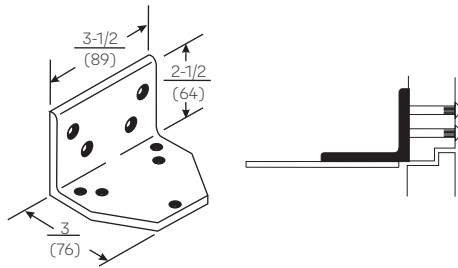

Flush Transom - 293L Angle Bracket: For use where flush transom conditions prevent installation of the standard hold open soffit plate. Used for parallel hold open arms.

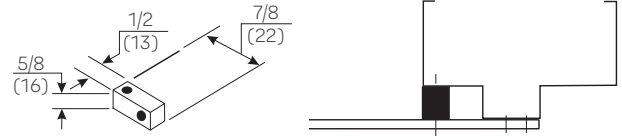

Standard - 293S Spacer Block: For use where a narrow frame soffit does not provide adequate support for the soffit plate. Supplied as standard with all rigid parallel arm closers.

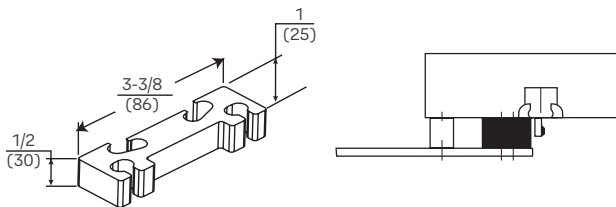

Clearance/Support Blade Stop - 891 Spacer Block: For use where the frame has a blade stop and the soffit plate must be mounted on the frame rabbet. This accessory is used in combination with the standard Spacer Block to provide clearance of the blade stop.

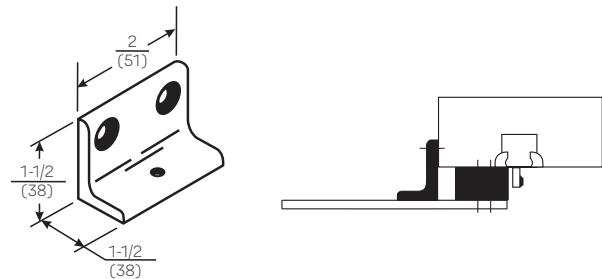

Narrow Frame - 890 Support Bracket: For use where the frame is narrow, and the soffit plate cannot be mounted directly to the frame soffit or rabbet. Used in combination with the 891 Spacer Block on blade stop frames to provide extra support and needed clearance of the blade stop.

Closer Mounting Plates

Narrow Top Rail - 1988 Drop Plate: For use where a narrow top rail prevents the closer from being mounted directly to the door surface.

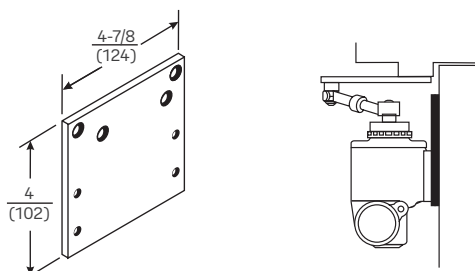

UNI Stop™ Arm



Brackets

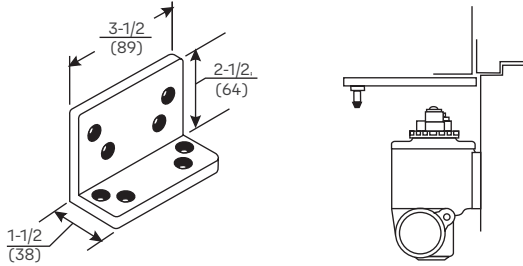

Flush Transom - 589L Angle Bracket: For use where rabbeted or flush transom conditions prevent installation of a soffit plate. Used in combination with the 289 soffit plate, or it may be used in combination with the 290 soffit plate when it is necessary for the closer arm to clear a separate overhead door holder.

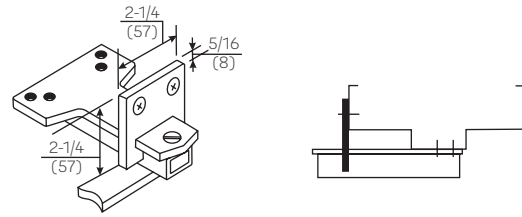

Additional Support - 6190 Reinforcing Bracket: Standard for use with all parallel arm door controls. Provides additional support to the soffit plate on installations with door frame reveals from 1-7/8" to 4-5/8" (48 to 117mm).

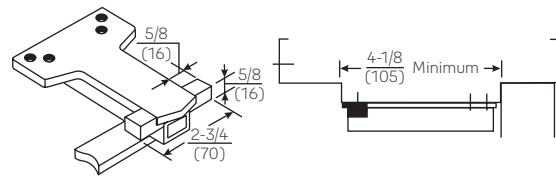
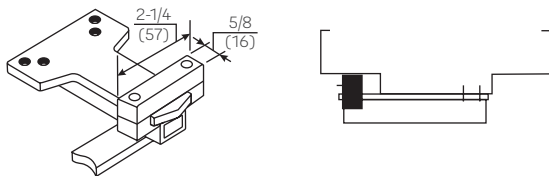

Wide Frame - 6191 Reinforcing Kit: Optional for use with all parallel arm UNI Stop door controls. Used to support the soffit plate on installations with wide frames. Clamps may be used with or without the spacer block, depending on frame conditions.

Closer Mounting Plates

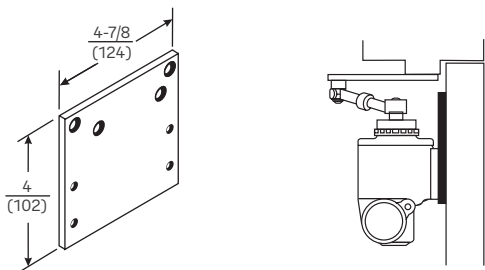

Narrow Top Rail - 1988 Drop Plate: For use where a narrow top rail prevents the closer from being mounted directly to the door surface.

Corner Brackets



The following frame-mounted brackets, 1950, 2950 and 964, require the use of a door closer of the opposite hand from the hand of the door. Use the Parallel Arm Sizing Chart to select the correct size of closer to use, when the closer is to be mounted on a corner bracket.

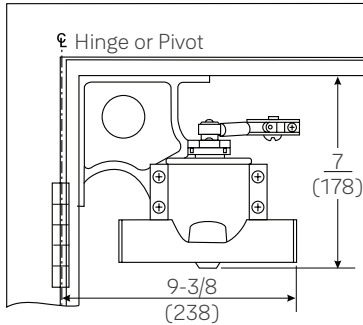

Corner Mounting, Standard Drop - 1950 Corner Bracket: For use where door is required to open to 180°. Minimum soffit width 1-3/8" (35mm).

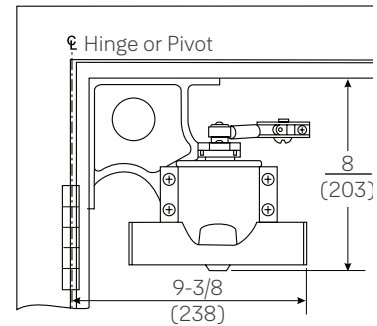

Corner Mounting, Extra Drop - 2950 Corner Bracket: For use with a separate overhead door holder. Drops closer 1" (25mm) lower than 1950 Standard Drop Corner Bracket to permit mounting of an overhead holder. Permits door openings to 180°. Minimum soffit width 1-3/8" (35mm).

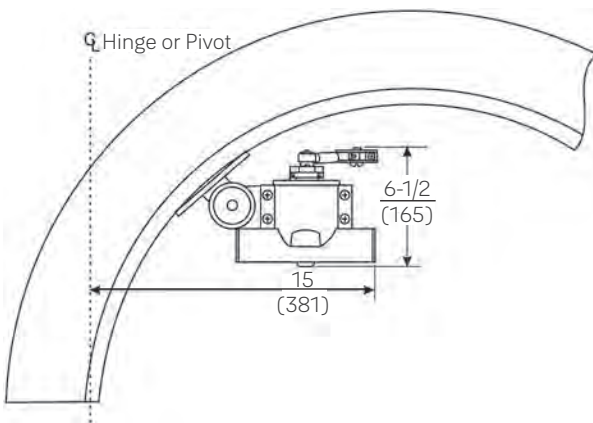

Arched or Circular Top Door - 964 Adjustable Bracket: For opposite hinge side application on arched or circular top doors. This frame-mounted bracket can be adjusted to accommodate virtually any radius of frame. Minimum soffit width 2-1/2" (64mm). This bracket requires the use of a door closer of the opposite hand from that of the door. Intended for 90° swing.

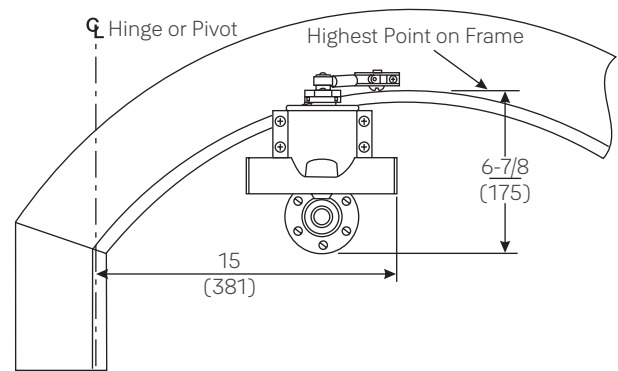

Arched or Circular Top Door - 974 Offset Adjustable Bracket: For hinge side application on arched or circular top doors. This door-mounted bracket is adjustable to accommodate virtually any radius of frame. Base diameter 3-5/8" (92mm). Intended for 90° swing.

Adapter Plates



Size Closer Being Replaced	Adapter Plate Catalog Number	Dimensions	
		A	B
992/993	1983	5-1/2" (140)	2-5/8" (67)
994	None Required	—	—
995/996	1986	5-1/2" (140)	2-5/8" (67)

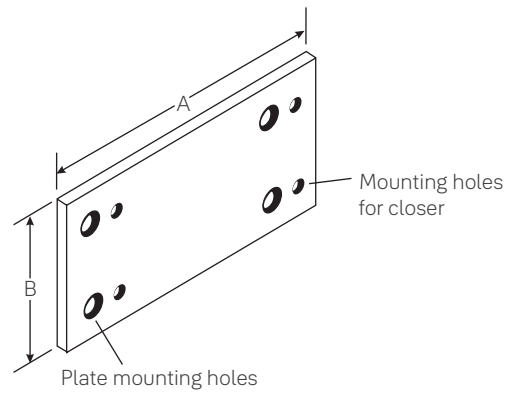

1980 Series Adapter Plate

For use when replacing a discontinued old style 990 Series surface closer with a series 1900 Traditional Surface Closer. The plate selected will employ the existing holes in either door or corner bracket. The Series 1900 closer will mount to the plate. These plates can be used to convert regular arm, parallel arm or bracket mount installations. Order by model number.

Parts List



Regular Arm

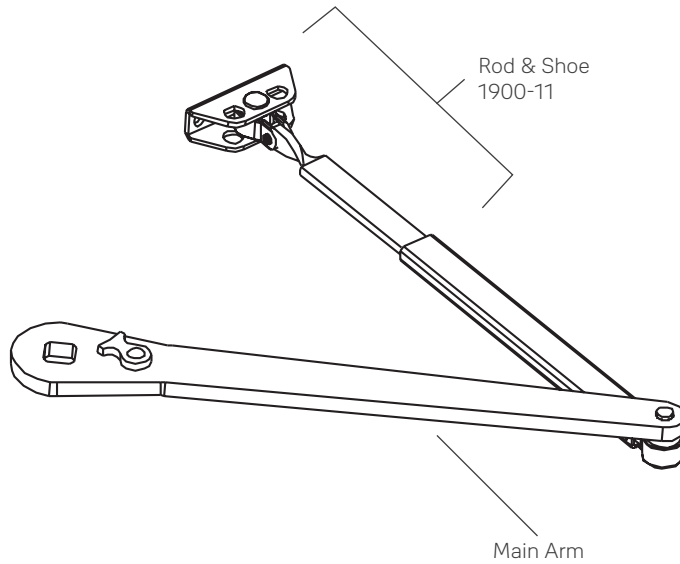

Note: Mounting hardware included with all parts ordered

Arm Function	Complete Arm Assembly	Main Arm	Main Arm Less Rod & Shoe
Non-Hold Open	Y1900-1	1900-1M	Y1900-1W

Parts List



Parallel Arm

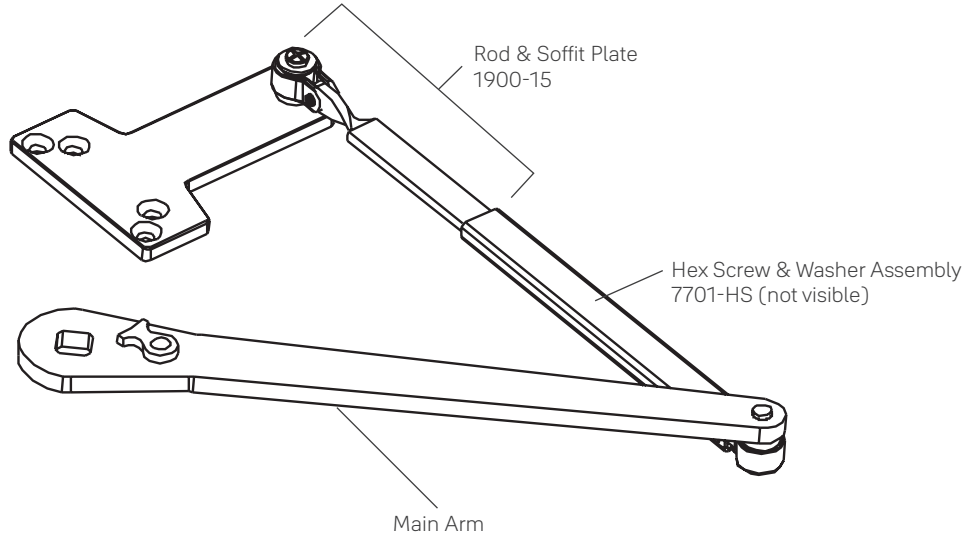

Note: Mounting hardware included with all parts ordered

Arm Function	Complete Arm Assembly	Main Arm	Main Arm Less Rod & Soffit Plate
Non-Hold Open	Y1900-5	1900-1M	Y1900-1W

Parallel Rigid Arm Assemblies

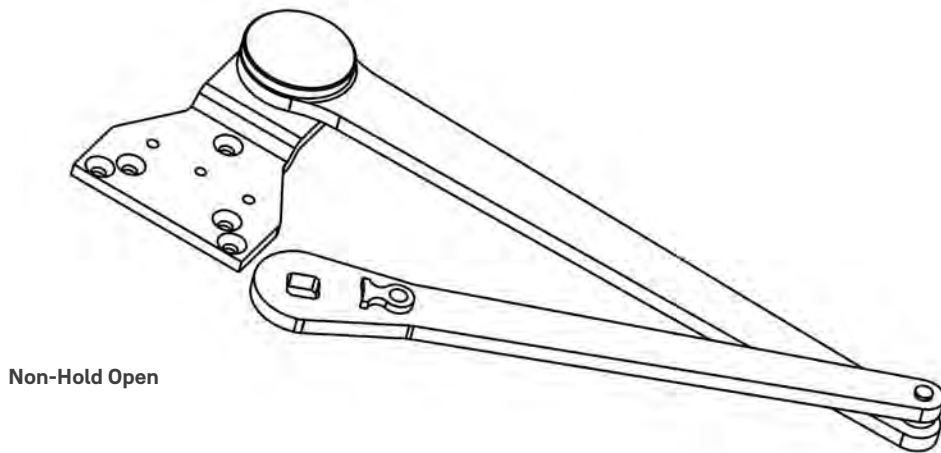

Non-Hold Open

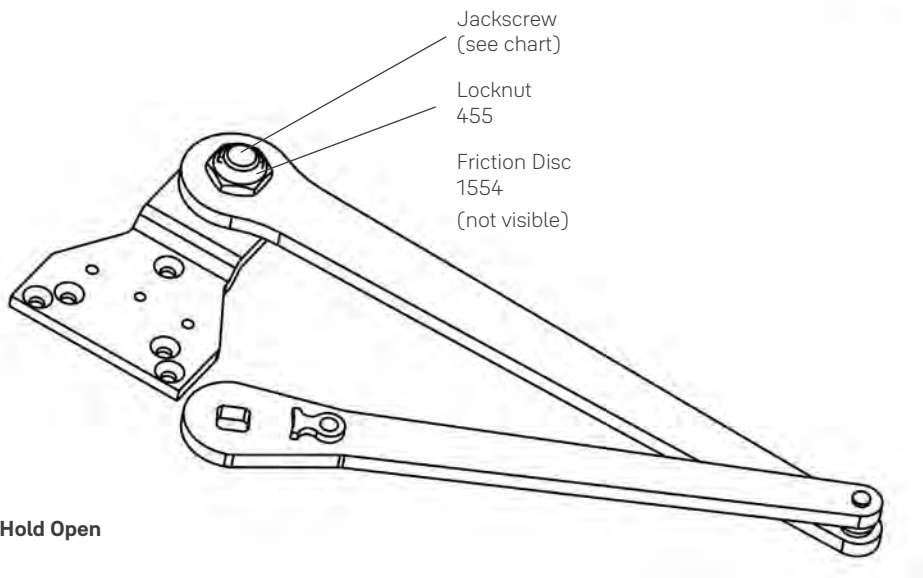

Hold Open

Jackscrew
(see chart)

Locknut
455

Friction Disc
1554
(not visible)

Note: Mounting hardware included with all parts ordered

Arm Function	Complete Arm Assembly	Jackscrew
Non-Hold Open	PR1900-5	N/A
Hold Open	PR1900-8R (Right Hand)	1543R
	PR1900-8L (Left Hand)	1543L



UNI Stop™ Arm Assemblies

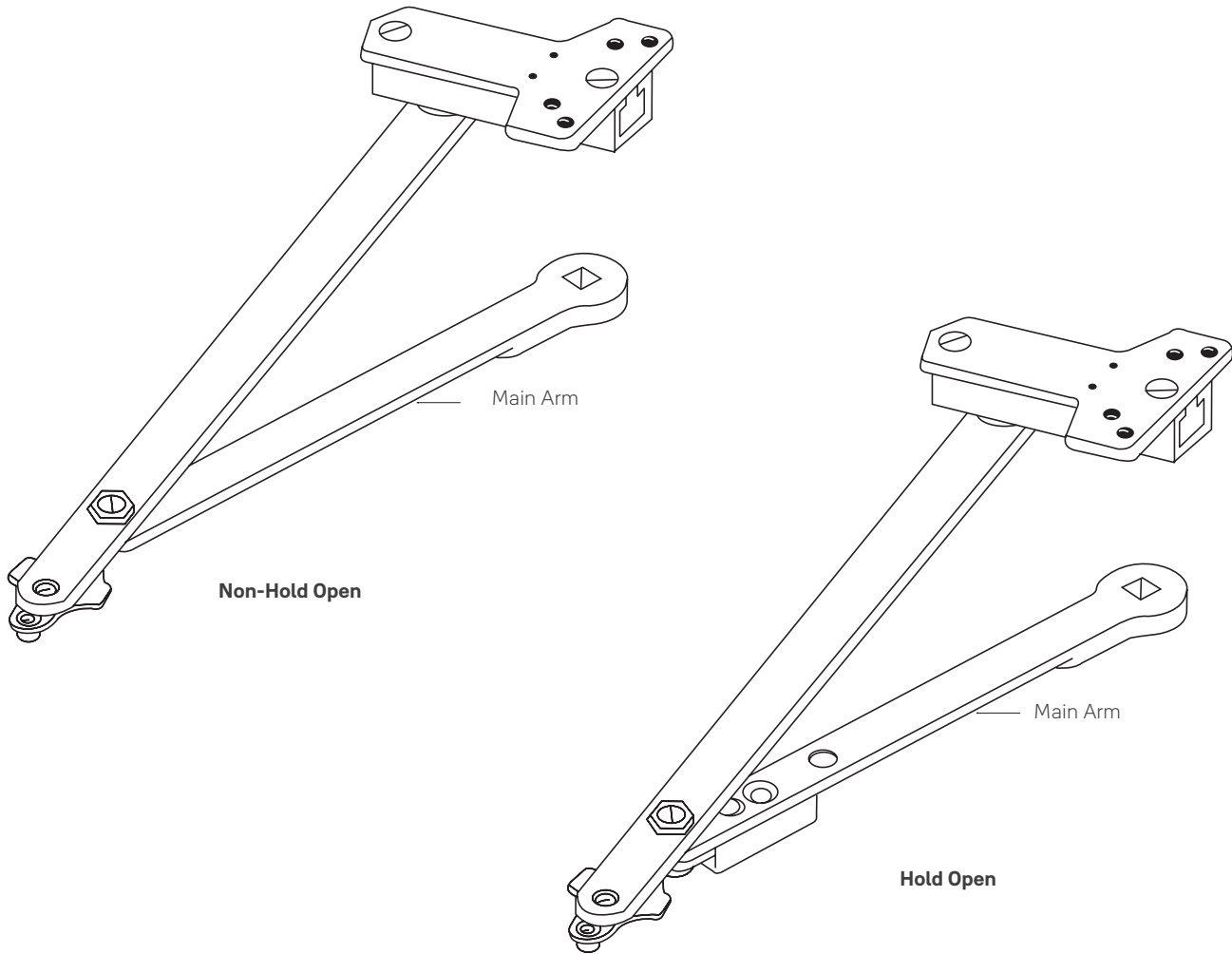

Note: Mounting hardware included with all parts ordered

Door Width (cm)	Main Arm Length* (mm)	Complete Arm Assembly	
		Non-Hold Open	Hold Open
28" - 32" (71 - 81)	9-1/2" (241)	6130-17	6130-7
33" - 41" (84 - 104)	11" (279)	6130-18	6130-8
42" - 48" (107 - 122)	12-1/2" (318)	6130-19	6130-9

* Center to center length



Miscellaneous Parts

Springs		Closer Bodies	
24BD	B/D Spring	1902/4 LAP	Size 2-4 body
56EF	E/F Spring	1905/6 LAP	Size 5/6 body

Screw Packs

Sex Nuts		Thru Bolts & Grommet Nuts	
SN-134	1-3/4" door	TBGN138-38	1-3/8" door
SN-214	2-1/4" door	TBGN134-38	1-3/4" door
		TBGN214-38	2-1/4" door

Fasteners

Type	Description	Arm			
		RA	PA	PR	UNI STOP™
DOOR					
SDST	Self-Drilling Self-Tapping	S	S	S	S
MS	Machine Screw	S	S	S	S
SN	Sleeve Nut	O	O	S	S
TBGN	Thru Bolts & Grommet Nuts	O	O	O	O
FRAME					
SDST	Self-Drilling Self-Tapping	S	S	S	S
MS	Machine Screw	S	S	S	S

S = standard; O = optional

SN are for use on unreinforced hollow metal doors or to prevent any hollow metal door from collapse/dimpling. They can also be used for thru bolting on wood doors. SN are supplied for 1-3/4" (44mm) thick doors unless specified for 2-1/4" (57mm).

TBGN are an alternative to SN for wood doors. TBGN are supplied standard for 1-3/4" (44mm) thick doors. They can be specified for 1-3/8" (35mm) thick doors.

Specifications



Closer for interior (and) exterior doors shall be rack-and-pinion type enclosed in a cast aluminum alloy shell. Closer spring shall be clock-type coil spring and shall be adjustable through a range of closing power. Closer fluid shall maintain lubricity and contain anti-oxidation agents. Closer shall be equipped with a single hex-key operated regulating valve for control of both closing and latch speeds. Closer shall have adjustable backcheck. Closer shall be Yale® 1900 Series Traditional Surface Closer or equivalent.









Trusted every day

Customer Service Phone:

1-800-438-1951

Customer Service Fax:

1-800-338-0965

24/7 Support Phone:

1-855-213-5841

24/7 Support Email:

support@yalelock.com

Website:

yalecommercial.com

Email for orders:

orders.yaleus@assaabloy.com

Contact Us

U.S.A.

Yale Locks & Hardware

Address: 225 Episcopal Road

Berlin, CT 06037-4004

Tel: 1-800-438-1951

Fax: 1-800-338-0965

yalecommercial.com

Canada:

ASSA ABLOY Door Security Solutions Canada

Address: 160 Four Valley Drive

Vaughan, Ontario L4K 4T9

Tel: 1-800-461-3007

Fax: 1-800-461-8989

assaabloydss.ca

International:

ASSA ABLOY Americas International

Tel: 1-905-821-7775

Fax: 1-905-821-1429

assaabloyai.com

THE YALE BRAND, with its unparalleled global reach and range of products, reassures more people in more countries than any other consumer locking solution.

THE ASSA ABLOY GROUP is the world's leading manufacturer and supplier of locking solutions, dedicated to satisfying end-user needs for security, safety and convenience.

Yale Commercial is a business associated with ASSA ABLOY Access and Egress Hardware Group, Inc., an ASSA ABLOY Group company. Copyright © 2001-2020, ASSA ABLOY Access and Egress Hardware Group, Inc. All rights reserved. Reproduction in whole or in part without the express written permission of ASSA ABLOY Access and Egress Hardware Group, Inc. is prohibited. Patent pending and/or patent www.assaabloydss.com/patents.



nexTouch™

Keypad Locks



An ASSA ABLOY Group brand

ASSA ABLOY



Contents

One Lock Platform, Three Technologies	3	nexTouch exit trim	33
Features & Benefits	4	How to Order.....	34
nexTouch cylindrical.....	5	Trim Designs	35
How to Order.....	6	Finishes	36
Trim Designs	7	Functions.....	37
Finishes	8	Cylinders.....	38-40
Functions.....	9	Cylinder Collars.....	41
Cylinders.....	10-11	Dimensions.....	42
Latchbolts.....	12	Technology Options	43
Strikes	13	Options & Accessories.....	44
Dimensions	14	Certifications & Listings.....	45
Technology Options	15		
Options & Accessories.....	16		
Certifications & Listings.....	17		
nexTouch sectional mortise	18		
How to Order.....	19		
Trim Designs	20-21		
Finishes	22		
Functions.....	23		
Cylinders.....	24-26		
Cylinder Collars.....	27		
Strikes	28		
Dimensions	29		
Technology Options	30		
Options & Accessories.....	31		
Certifications & Listings.....	32		

The fully modular design of Yale nexTouch allows users to easily upgrade to more advanced security technologies as their requirements grow and change.

Standalone Keypad

Great for restrooms, offices, storage closets and more, nexTouch as a standalone keypad is easy to install, program, and manage access with PIN codes.



Data-on-Card

In new construction or retrofit projects for multi-family facilities, the data-on-card functionality of nexTouch pairs with Yale Accentra™ software for use with key cards or fobs.



Wireless

The perfect solution for small business, nexTouch allows wireless integration of the lock into new or existing commercial automation systems.





Features & Benefits

Feature	Benefit
Choice of capacitive touchscreen or tactile pushbutton keypad	Touchscreen responds to human touch, enabling convenient entrance or access to programming menu. Pushbutton keypad option also available for more tactile requirements, such as ADA compliance.
Keyless entry and management	Reduces complexity of key system management
PIN code access	Installations are able to be programmed with up to 500 unique PIN codes and a master code for access to programming.
Modular technology	Allows for upgrade to more advanced security technologies with Data-on-Card and ZigBee/Z-Wave capabilities as requirements change and grow.
Works with cloud-based management software	Single system enables use from anywhere with Internet access from a range of devices, including your computer, smartphone or tablet.
Audit trail	Lifetime audit trail stored within the software to know exactly who has accessed the lock when.
Voice-guided programming in 3 languages	Voice-guided prompts make updates straightforward and effortless in English, Spanish or French.
Three (3) volume modes	Playback can be set for normal, low or silent.
Privacy feature with Door Position Switch	By holding the interior lock button down for 1.5 seconds, the exterior keypad is temporarily disabled ensuring complete privacy and no additional entry.
Weather resistant gasket seal	Lock is operational even in outdoor settings, in temperatures ranging from -40°F to 140°F (-40°C to 60°C) at 95% relative humidity.
Low battery indicator	Blinking designation signals internal 4 AA alkaline batteries are low.
9V battery power backup feature	With the touch of a 9V battery to the designated area on the front of the lock, your nexTouch can be powered up for one-time entry.
Hardwire power capable	Can be powered externally using remote 9VDC power supply and plug-in wall transformer.
Keypad lockout feature	Deters tampering by disabling the keypad for a default of 180 seconds after five (5) successive failed attempts.



nexTouch™ Cylindrical





How To Order

CYLINDRICAL

Quantity	Lever Design	Series/Function	Technology	Finish	Door Thickness	Cylinder	Latch	Strike
#	AU - Augusta	NTB610 - Bored lock, key override, pushbutton keypad	NR - Keypad only, no radio	605 - Bright brass, clear coated	1-3/4" 1-3/8"	1803-53L - 6-pin cylinder standard, see pages 10-11 for additional options ¹	694 latchbolt with 2-1/4" x 1-1/8" front, 2-3/4" backset and 1/2" bolt throw standard, see page 12 for additional options	497 ANSI strike standard, see page 13 for additional options
	MO - Monroe	NTB620 - Bored lock, key override, capacitive touchscreen keypad	ZW2 - Z-Wave wireless communication	613E - Dark oxidized bronze - equivalent				
	PB - Pacific Beach	NTB630 - Bored lock, no key override, pushbutton keypad		626 - Satin chrome plated				
		NTB640 - Bored lock, no key override, capacitive touchscreen		BSP - Black suede powder coat				

¹When ordering SFIC and LFIC cylinders, please use appropriate prefix before lever selection. See page 11 for more information.

BUILD YOUR ORDER STRING

Quantity	Lever Design	Series/Function	Technology	Finish	Door Thickness	Cylinder	Latch	Strike
<i>Example:</i>	AU	NTB620	NR	626	1-3/4"	1803-53L	694	497

Trim Designs

CYLINDRICAL

AUGUSTA AU
Lever: Cast Zinc

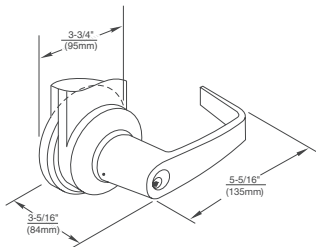

MONROE MO
Lever: Cast Zinc

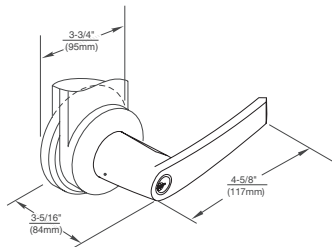



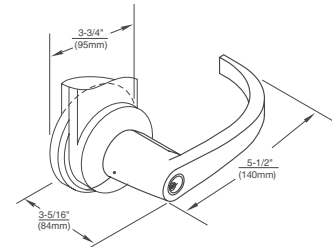

PACIFIC BEACH PB
Lever: Cast Zinc



All levers available with small and large format interchangeable core. See page 11 for details.



Finishes

ANSI/BHMA Code Finish Description			
605 Bright Brass, Clear Coated	613E Dark Oxidized Satin Bronze - equivalent	626 Satin Chrome Plated	BSP Black Suede Powder Coat
			

Functions

CYLINDRICAL

NTB630 Pushbutton NTB640 Touchscreen

Without Cylinder Override

- For doors that do not require mechanical key override.
- Latchbolt retracted by lever outside with valid PIN code, or by operating lever inside.
- Inside lever always active.
- Deadlocking latchbolt.

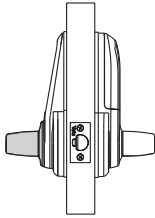

Outside

Inside

NTB610 Pushbutton NTB620 Touchscreen

With Cylinder Override

- For doors that require mechanical key override.
- Latchbolt retracted by lever outside with valid PIN code; by use of mechanical key, or by operating lever inside.
- Inside lever always active.
- Deadlocking latchbolt.

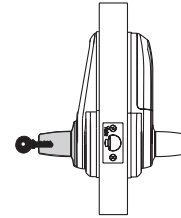

Outside

Inside



Cylinders

CYLINDRICAL

Cylinder Options

The following selection guide indicates the correct cylinder for each locking segment.

Lockset Series nexTouch™	Types of Cylinder Mechanisms						
	Fixed Core	Conventional		Protected Keyway		Security	
Cylinder Types		6-pin	7-pin	6-pin	7-pin	6-pin	7-pin
Key-In-Lever	1803-53L	N/A	K403-53L	N/A	5803-53L	N/A	
Interchangeable Core							
LFIC	1210	N/A	K800	N/A	5210	N/A	
SFIC	A600	A600	K600	K600	N/A	N/A	

Note: The 1803-53L Cylinder requires an adapter sleeve to fit in the nexTouch lockset. (P/N 14-YM00-9078-999)

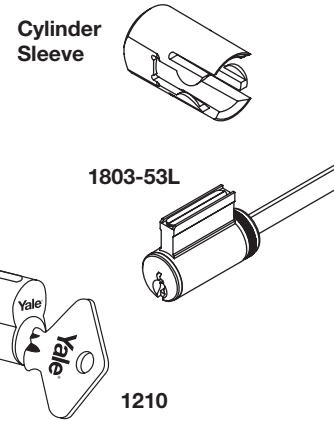

Refer to Yale® KeyMark® and/or Cylinders and Keys Catalog sections for all details and how-to-order examples.

Other Manufacturers' Keyway Cylinders

Illustration	Description	Model Number	Number of Pins
	Best® Keyway Cylinder. Available keyed random, master keyed or uncombined. Specify keyway A, B, C, D, E, F, G, H, J, K, L or M.	A600	6 or 7
	Schlage® "C" Keyway. Available 0-bitted or keyed random.	2803-53L*	6
	Corbin Russwin "L4", Corbin "60", Russwin "D1", Sargent® "LA" or Schlage® "E" Keyway. Specify keyway. Available keyed random.	3803-53L*	6
	Arrow "AR" Keyway. Specify keyway. Available keyed random.	100CV1	6

*The 2803-53L and 3803-53L cylinders require a cylinder sleeve (P/N 14-YM00-9078-999) to fit the nexTouch™ lockset.

Cylinders

CYLINDRICAL (CONTINUED)

Levers Accepting SFIC And Other Manufacturers' Large Format Interchangeable Cores

	Description	Lever Prefix	Number of Pins
	SFIC (Accepts all Small Format Interchangeable Cores)	B (i.e. B-AU, B-MO, B-PB)	6 or 7
	Corbin Russwin (LFIC)	R (i.e. R-AU)	6
	Medeco®, ASSA® (LFIC)**	M (i.e. M-AU)**	6
	Sargent (LFIC)	SG (i.e. SG-AU, SG-PB)	6
	Schlage® (LFIC)	SI (i.e. SI-AU, SI-PB)	6

**Medeco®, ASSA® option available only with AU lever. (Note: For Medeco 32 series cores.)

LFIC = Large Format Interchangeable Core

SFIC = Small Format Interchangeable Core

108 Schlage® Cylinder Adapter Kit

Kit used to modify Schlage® cylinder to fit nexTouch™.

P/N 14-5305-0090-048 - 108S

Kit includes tailpiece and sleeve. To order the 108S adapter kit, use an "S" prefix (i.e., S-AU x NTB610).

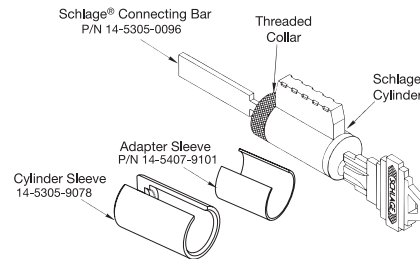



Latchbolts

CYLINDRICAL

Deadlocking Latchbolts

Model No. 694 supplied standard with all nexTouch™ locksets. Model No. 694 latchbolt has a 2-1/4" x 1-1/8" front with a 2-3/4" backset and a 1/2" bolt throw. Optional latchbolts to special order.

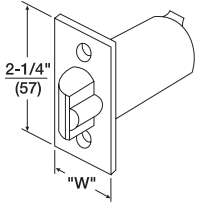

Model No.	Front	Backset	"W" Front Width	Throw	Latch Diameter
694 (standard)	Beveled	2-3/4" (70mm)	1-1/8" (29mm)	1/2" (13mm)	1" (25mm)
F694	Flat	2-3/4" (70mm)	1-1/8" (29mm)	1/2" (13mm)	1" (25mm)
480B	Beveled	2-3/4" (70mm)	1-1/8" (29mm)	3/4" (19mm)	1" (25mm)
F480B	Flat	2-3/4" (70mm)	1-1/8" (29mm)	3/4" (19mm)	1" (25mm)
380N*	Flat	2-3/8" (60mm)	1" (25mm)	1/2" (13mm)	3/4" (19mm)

When ordering latchbolts separately, specify Model No. x Finish (e.g., 694 x 626).

*Using 380N latch results in Grade 2 ANSI/BHMA performance of the lock.

Strikes

CYLINDRICAL

Yale® nexTouch™ locksets are available with a variety of strike options. All strikes are located on the same vertical and horizontal center lines as the latchbolt. Some strikes are available in a variety of lip lengths to accommodate varying thickness of doors and frames. To determine the proper length of the lip, measure from the center line of the strike to the edge of the jamb and add 1/4" (6mm). All strikes are reversible.

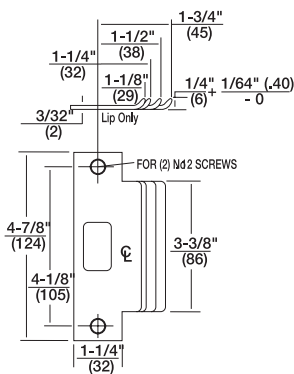

Model No. 497 ANSI Strike (Standard)

For door and frames with ANSI/BHMA A156.115 preparations. 1-1/4" supplied standard. 1-1/8", 1-1/2", and 1-3/4" lip lengths available by special order.

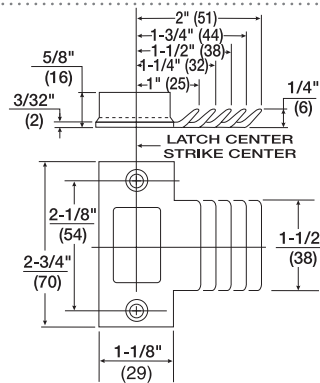

Model No. 371 T-Strike (Optional)

1-1/4" curved lip supplied standard. 1", 1-1/2", 1-3/4", and 2" curved lip lengths available by special order. Wrought strike box supplied.

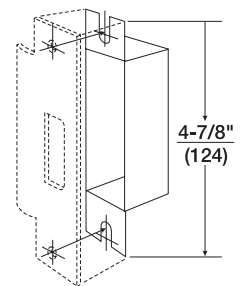

Model No. 202 Strike Box for ANSI Strike (Optional)

Specify 497 x 202



Dimensions

CYLINDRICAL

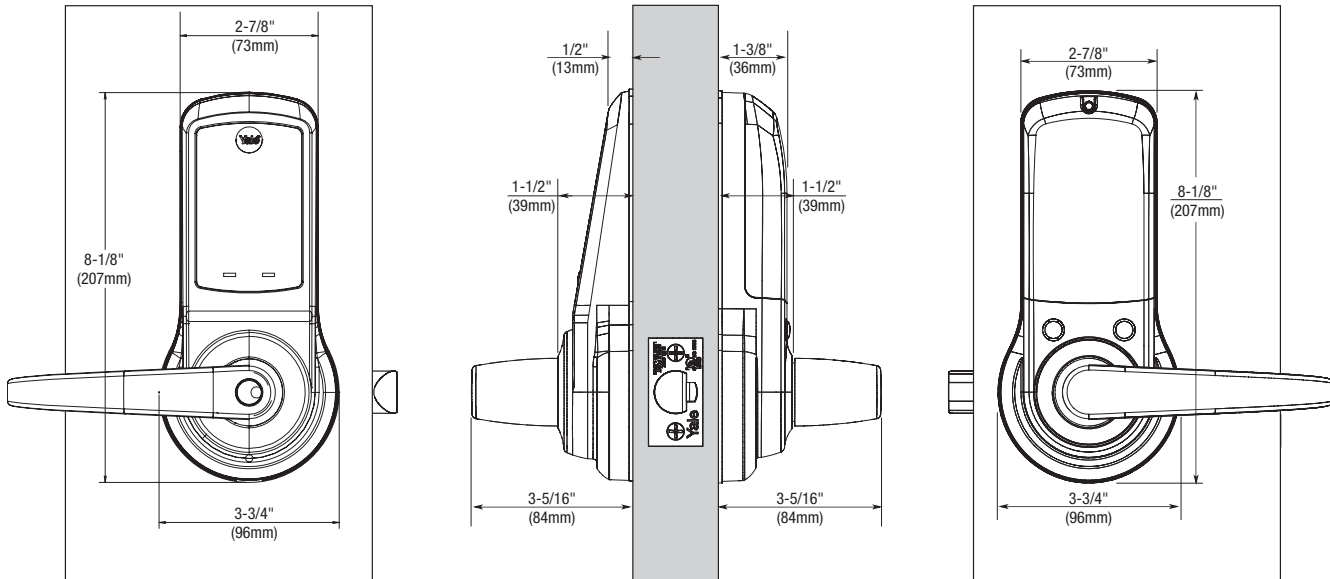

Dimensions given in inches (mm).



Technology Options

CYLINDRICAL

NR	Keypad only, no radio
ZW2	Z-Wave wireless communication

Yale Accentra™ Data-on-Card module available only through Authorized Channel Partners. If you require another module not listed in this catalog, please contact your local ASSA ABLOY Door Security Solutions sales representative.



Z-Wave Module



Options and Accessories

CYLINDRICAL

Model/Part Number	Description
784	Optional remote 9VDC power supply with plug-in wall transformer (used for hardwiring up to two nexTouch locks).
WH-28	Remote power wire harness (used for hardwiring).
00-0000-3425	Replacement plug-in wall transformer with 12' cable assembly for 784 power supply.

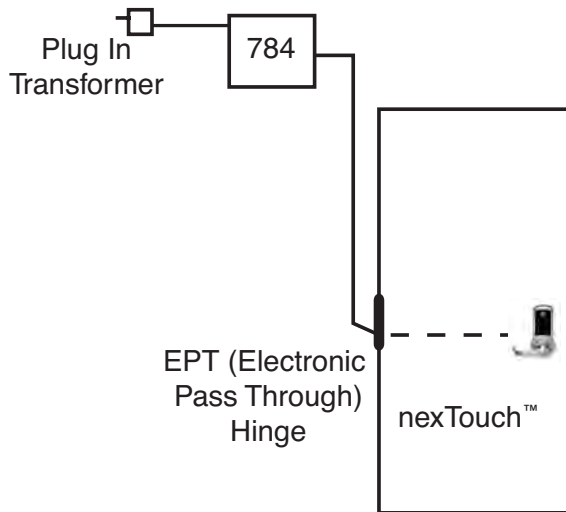



Certifications and Listings

CYLINDRICAL

ADA



The nexTouch Series lever design meets accessibility guidelines of the Americans with Disabilities Act and the requirements of the Uniform Federal Accessibility Standards and ICC/ANSI A117.1 Accessible and Usable Buildings and Facilities, all requiring ease of accessibility.

FCC

Complies with limits for a Class B digital device, pursuant to part 15 of the FCC Rules.

ANSI/BHMA

nexTouch cylindrical certified ANSI/BHMA A156.2, Series 4000 Grade 1.



ISO 14001

Designed and manufactured under a certified ISO 14001 quality system.

SUSTAINABILITY

EPD and GreenCircle certification.

FIRE LISTINGS



Functions are UL/cUL Fire Listed for use on fire doors having a rating up to and including 3 hours.

Note: Any retrofit or other field modification to a fire rated opening can potentially impact the fire rating of the opening, and Yale Locks & Hardware makes no representations or warranties concerning what such impact may be in any specific situation. When retrofitting any portion of an existing fire rated opening, or specifying and installing a new fire-rated opening, please consult with a code specialist or local code official (Authority Having Jurisdiction) to ensure compliance with all applicable codes and ratings.

WARRANTY

nexTouch has a three year limited warranty on the mechanical and electrical components, and a one year limited warranty on the finish.

WINDSTORM

Certified (refer to local codes).  Hurricane



nexTouch™ Sectional Mortise



SECTIONAL MORTISE

Touchscreen as shown when activated



Lockout Mode



Low Battery Indication

Weather Resistant Seal

9V Battery Power Backup

Reflections® decorative lever options available

Optional Security Deadbolt

Built-in DPS/Deadlocking Function





How to Order

SECTIONAL MORTISE

Quantity	Lever Design	Series/Function	Technology	Finish	Hand*	Door Thickness	Cylinder	Strike
	AUR – Augusta	NTM610 – Sectional mortise lock, key override, pushbutton keypad, no deadbolt	NR – Keypad only, no radio	605 – Bright brass, clear coated	RH LH	1-3/4" standard, up to 2-1/4" door thickness available	2153 cylinder standard, see pages 24-26 for additional options	2815 curved lip strike standard, see page 28 for additional options
	MOR – Monroe							
	PBR – Pacific Beach	NTM615 – Sectional mortise lock, key override, pushbutton keypad, with deadbolt	ZW2 – Z-Wave wireless communication	613E – Dark oxidized bronze - equivalent				
	ARR – Arcadia	NTM620 – Sectional mortise lock, key override, capacitive touchscreen, no deadbolt		626 – Satin chrome plated				
	CRR – Carmel							
	JNR – Jefferson	NTM625 – Sectional mortise lock, key override, capacitive touchscreen, with deadbolt		BSP – Black suede powder				
	PNR – Pinehurst							
	VIR – Virginia	NTM630 – Sectional mortise lock, no key override, pushbutton keypad, no deadbolt						
	See page 21 for Reflections decorative lever options	NTM635 – Sectional mortise lock, no key override, pushbutton keypad, with deadbolt						
		NTM640 – Sectional mortise lock, no key override, capacitive touchscreen, no deadbolt						
		NTM645 – Sectional mortise lock, no key override, capacitive touchscreen, with deadbolt						

*Lock is field reversible

BUILD YOUR ORDER STRING

Quantity	Lever Design	Series/Function	Technology	Finish	Hand	Door Thickness	Cylinder	Strike
<i>Example:</i>	AUR	NTM620	NR	626	RH	1-3/4	2153	2815

SECTIONAL MORTISE

Trim Designs

SECTIONAL MORTISE

SECTIONAL MORTISE

AUGUSTA AUR
AU Lever Handle: Cast

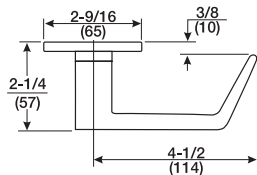

MONROE MOR
MO Lever Handle: Cast

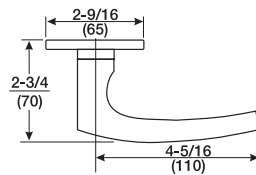

PACIFIC BEACH PBR
PB Lever Handle: Cast

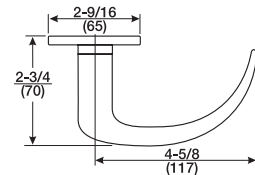

ARCADIA ARR
AR Lever Handle: Cast

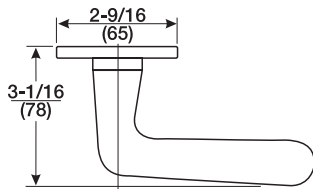

CARMEL CRR
CR Lever Handle: Cast

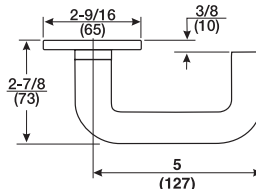

JEFFERSON JNR
JN Lever Handle: Cast

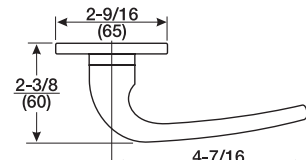

PINEHURST PNR
PN Lever Handle: Cast

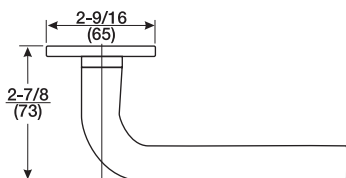

VIRGINIA VIR
VI Lever Handle: Cast

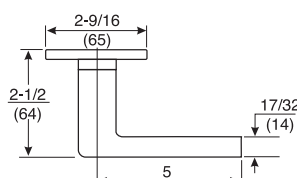



Reflections® Decorative Trim

Yale nexTouch sectional mortise locks are available with Reflections lever trim, a comprehensive line of highly stylized lever handles. Reflections lever handles are made from solid brass or stainless steel and can withstand years of abuse. Available in an array of finishes, these levers complement any wood grain or other door exterior. Each lever is hand-polished and specially designed for ergonomics and style.

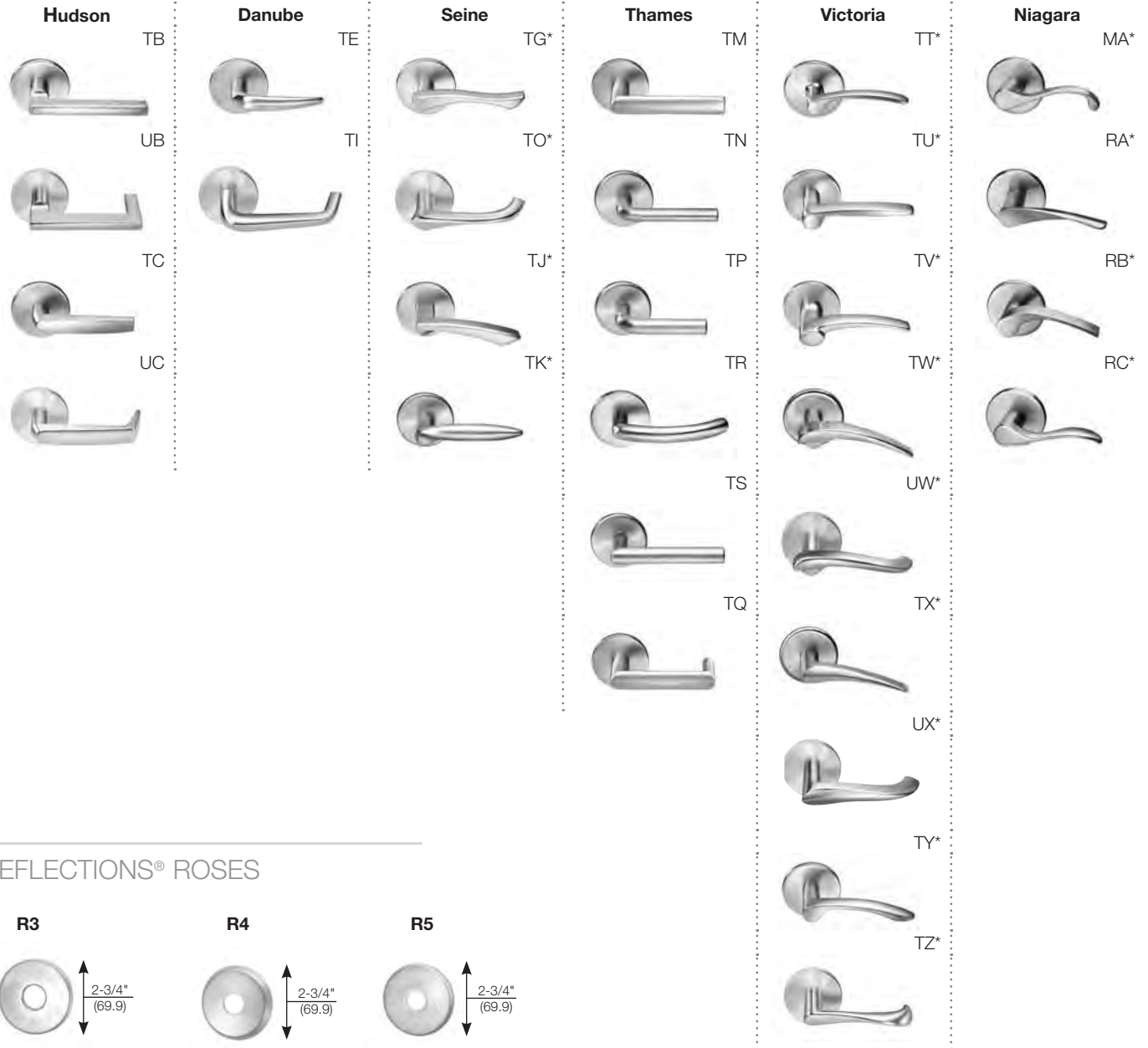

SECTIONAL MORTISE

REFLECTIONS® ROSES

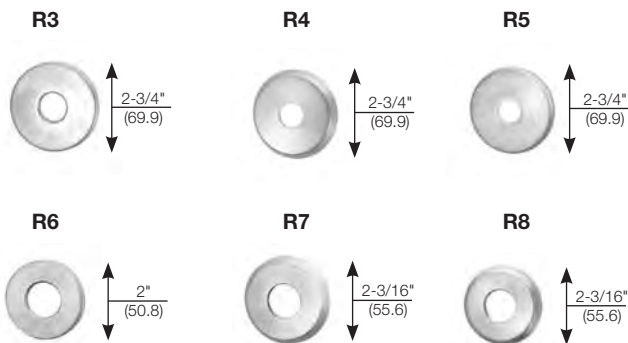

*Indicates levers that are handed.



Finishes

SECTIONAL MORTISE

SECTIONAL MORTISE

ANSI/BHMA Code
Finish Description

605
Bright Brass, Clear Coated



613E
Dark Oxidized Satin Bronze -
equivalent



626
Satin Chrome Plated



BSP
Black Suede Powder Coat



Functions

SECTIONAL MORTISE

NTM630 Pushbutton NTM640 Touchscreen

No Deadbolt Without Cylinder Override

- For doors that do not require mechanical key override.
- Latchbolt retracted by lever either side, except when outside lever is locked
- Deadlocking latchbolt.

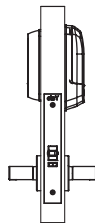

Outside Inside

NTM610 Pushbutton NTM620 Touchscreen

No Deadbolt With Cylinder Override

- For doors that require mechanical key override.
- Latchbolt retracted by lever either side, except when outside lever is locked.
- When outside lever is locked, latchbolt is operated by key outside.
- Deadlocking latchbolt.

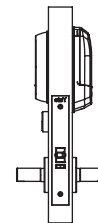

Outside Inside

NTM635 Pushbutton NTM645 Touchscreen

Deadbolt without cylinder override

- Latchbolt retracted by lever either side, except when outside lever is locked.
- Deadbolt operated by thumbturn inside.
- When deadbolt is projected, lever is automatically locked.
- Anti-panic operation. Operating inside lever automatically retracts latch bolt and deadbolt with outside lever remaining locked.
- Deadlocking latchbolt.

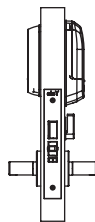

Outside Inside

NTM615 Pushbutton NTM625 Touchscreen

Deadbolt with cylinder override

- Latchbolt retracted by lever either side, except when outside lever is locked.
- Deadbolt operated by key outside, thumbturn inside.
- When outside lever is locked, latchbolt and deadbolt are operated by key outside.
- When deadbolt is projected, lever is automatically locked.
- Anti-panic operation. Operating inside lever automatically retracts latchbolt and deadbolt with outside lever remaining locked.
- Deadlocking latchbolt.

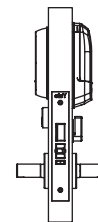

Outside Inside



Cylinders

SECTIONAL MORTISE

Conventional Cylinders

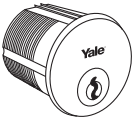
Illustration	Cylinder Model Number	Application	Cam	Length	
				6-Pin	7-Pin
	2153	Standard cylinder	2160	1-1/8" 1-1/4" 1-3/8"	1-1/4" 1-3/8" 1-1/2"
	2153S	For inside operation of 8817-2 and 8834-2 functions only	2130	1-1/2" 1-5/8" 1-3/4"	1-5/8" 1-3/4"
	2123	Cylinder for longer lengths	2160	1-7/8" thru 3-1/2" in 1/8" increments*	
	2123S	For inside operation of 8817-2 and 8834-2 functions only for longer lengths	2130		
	2719	For hotel/motel locks 8820, 8827 and 8832	2160	1-3/8"	—

*Contact Technical Product Support for cylinder collar requirements when ordering these cylinders separately. See page 27 for other collar requirements.

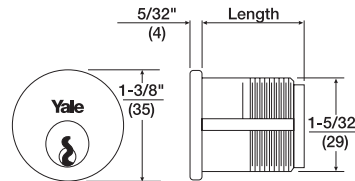

Interchangeable Core Mortise Cylinders

Cylinder Model Number	Application	Cam	Length	Pins	Housing Only Model Number	Core Only Model Number
2196	Standard Cylinder	2160	1-1/2", 1-3/4", 2"	6	2221	1210
2197	Standard Cylinder	2160	1-11/16", 2"	7	2213	1220

Note: When ordering interchangeable core cylinders or cores only, control keys are not furnished. If control keys are required they must be ordered separately.

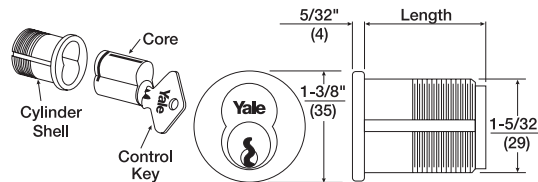

Cylinders

SECTIONAL MORTISE (CONTINUED)

Security Cylinders

Security cylinders contain two independent locking mechanisms. The first is a traditional 6- or 7-pin tumbler mechanism with spool drivers for greatly increased picking resistance.

The second is an innovative 5-tumbler rotating disc mechanism with sidebar engagement. The rotating discs are spring loaded and block the bottom of the keyway.

Illustration

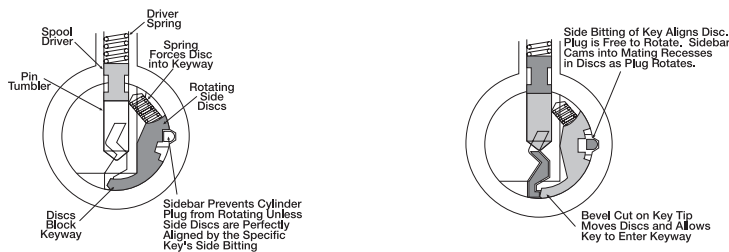

Security/High Security Mortise Cylinders

Model Number	Application	Cam	Length	
			6-pin	7-pin
5153/U5153	Standard Cylinder	2160	1-1/8" 1-1/4"	1-1/4"

Security Interchangeable Core Mortise Cylinders

Cylinder Model Number	Application	Cam	Length	Pins	Housing Only Model Number	Core Only Model Number
5196	Standard Cylinder	2160	1-1/2"	6	2221	5210
5197	Standard Cylinder	2160	1-11/16"	7	2213	5220



Note: When ordering interchangeable core cylinders or cores only, control keys are not furnished. If control keys are required they must be ordered separately.



Cylinders

SECTIONAL MORTISE (CONTINUED)

Other Manufacturers' Keyway Cylinders/Cores

Illustration	Model Number	Type	Cam	Length	Pins	Housing Only Model Number	Core Only Model Number
	A620	Small Format IC Mortise, includes Best® Keyway Core. Available keyed random, master keyed or uncombined. Specify keyway A, B, C, D, E, F, G, H, J, K, L or M.	KC1	1-1/4" 1-3/8" 1-3/4"	6 6 or 7	K660	A600
	2553	Fixed Core Mortise Schlage® "C" Keyway Cylinder. Available 0-bitted or keyed random.	2160	1-1/8"	6	N/A	N/A

Yale® KeyMark®

For those applications requiring protected key control, Yale® KeyMark® cylinders guard against unauthorized key duplication. The Yale KeyMark Security Leg® keyway feature increases resistance against picking and impressioning and can easily retrofit into existing systems. For further details and availability, refer to the separate Yale KeyMark catalog.

Protected Keyway Mortise Cylinders

Model Number	Type	Cam	Length	Pins	Housing Only Model Number	Core Only Model Number
K100	Fixed Core Mortise	KC1	1-1/8", 1-1/4" 1-1/2", 1-3/4" 2"	6 or 7	N/A	N/A
K820	Large Format IC Mortise	KC1	1-1/2", 1-3/4" 2" 1-11/16" 1-3/4", 2"	6 7	K860	K800
K620	Small Format IC Mortise	KC1	1-1/4" 1-3/8", 1-3/4"	6 6 or 7	K660	K600
K630	Small Format IC Mortise-Tapered	KC1	1-1/4" 1-3/8"	6 6 or 7	K670	K600



Cylinder Collars

SECTIONAL MORTISE

Cylinder collars are supplied as standard where required with those locksets supplied with cylinders. Collar size and thickness are supplied to suit the length of the cylinder, the thickness of the door and the trim ordered. (If door thickness is not specified, collars will be furnished for 1-3/4" (44mm) door.)

Collar length required must be specified for cylinders and/or housings ordered separately.

1765 Recessed Cylinder Collar
"A" Dimension: Thicknesses from 1/16" (2mm) to 1-15/32" (37mm) as required.
Material: Brass, Stainless Steel

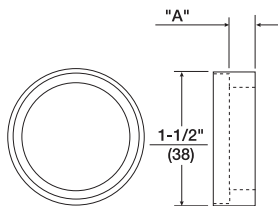

1766 Step Collar for U5109 and U5153 High Security Cylinders.
Material: Stainless Steel

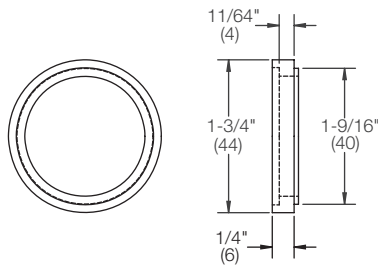

KP3 Wave Washer
(Furnished standard with 1765 collar for Yale® KeyMark® cylinders only).



KP4 Flush Mount Cylinder Collar
Material: Brass, Bronze

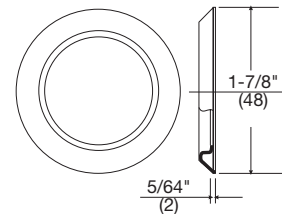

SECTIONAL MORTISE



Strikes

SECTIONAL MORTISE

Yale nexTouch Keypad Sectional Mortise Locks come standard with a 2815 Curved Lip Strike with a 1-1/4" (32mm) lip length. The strike supplied will accommodate the locking function, i.e. latchbolt and/or deadbolt, and can be installed on doors 1-3/4" (44mm) thick. These strikes are non-handed.

Material: Brass, Bronze, Stainless Steel.

Longer/Shorter Lip Lengths: Mortise lock strikes are mounted 3/8" above the center line of the lock. To determine the proper length of lip use the following formula:

1/2 of the door thickness, plus 1/16" inset, plus trim thickness, plus 1/8" for flat lip strike OR 1/4" for curved lip strike. Select the nearest available length.

2815 Curved Lip:

1-1/4" (32mm) standard

Available for special order:

1-1/8" (29mm)

1-3/8" (35mm)

1-1/2" (38mm)

1-5/8" (41mm)

1-3/4" (44mm)

1-7/8" (48mm)

2" (51mm)

2-1/8" (54mm)

2-1/4" (57mm)

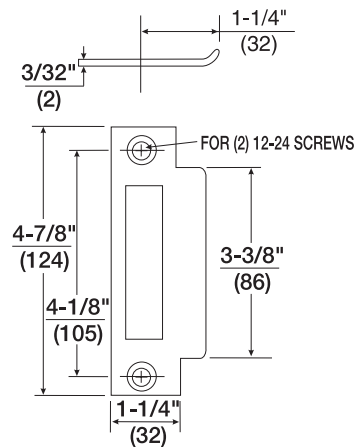

2815 Curved Lip Strike
(1-1/4"/32mm standard)

2816 Flat Lip (Available for special order only):

7/8" (22mm)

1" (25mm)

1-1/8" (29mm)

1-1/4" (32mm)

1-1/2" (38mm)

1-3/4" (44mm)

2" (51mm)

2-1/4" (57mm)

2-1/2" (64mm)

SECTIONAL MORTISE



Dimensions

SECTIONAL MORTISE

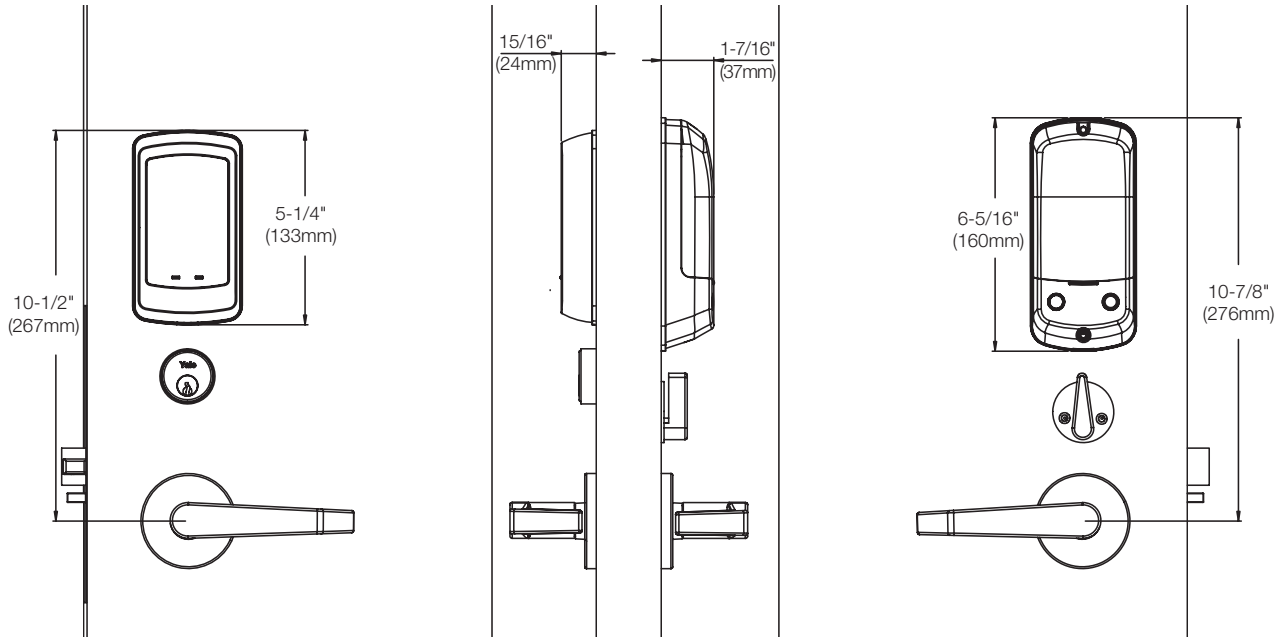

Dimensions given in inches (mm).

SECTIONAL MORTISE



Technology Options

SECTIONAL MORTISE

NR	Keypad only, no radio
ZW2	Z-Wave wireless communication

Yale Accentra™ Data-on-Card module available only through Authorized Channel Partners. If you require another module not listed in this catalog, please contact your local ASSA ABLOY Door Security Solutions sales representative.



Z-Wave Module



Options and Accessories

SECTIONAL MORTISE

Model/Part Number	Description
784	Optional remote 9VDC power supply with plug-in wall transformer (used for hardwiring up to two nexTouch locks).
WH-28	Remote power wire harness (used for hardwiring).

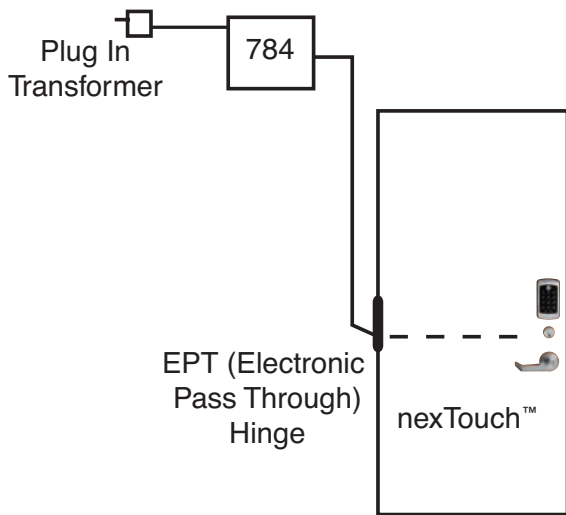

Model/Part Number	Description
50-M600-0150-033	Scar plate, inside without thumbturn
50-M600-0151-033	Scar plate, inside with thumbturn
50-M600-0152-033	Scar plate, inside with cylinder
50-M600-0153-033	Scar plate, inside without cylinder



Certifications and Listings

SECTIONAL MORTISE

ADA



The nexTouch Series lever design meets accessibility guidelines of the Americans with Disabilities Act and the requirements of the Uniform Federal Accessibility Standards and ICC/ANSI A117.1 Accessible and Usable Buildings and Facilities, all requiring ease of accessibility.

FCC

Complies with limits for a Class B digital device, pursuant to part 15 of the FCC Rules.

ANSI/BHMA

nexTouch mortise certified ANSI/BHMA A156.13, Series 1000 Grade 1.



ISO 14001

Designed and manufactured under a certified ISO 14001 quality system.

SUSTAINABILITY

EPD and GreenCircle certification.

FIRE LISTINGS



Functions are UL/cUL Fire Listed for use on fire doors having a rating up to and including 3 hours.

Note: Any retrofit or other field modification to a fire rated opening can potentially impact the fire rating of the opening, and Yale Locks & Hardware makes no representations or warranties concerning what such impact may be in any specific situation. When retrofitting any portion of an existing fire rated opening, or specifying and installing a new fire-rated opening, please consult with a code specialist or local code official (Authority Having Jurisdiction) to ensure compliance with all applicable codes and ratings.

WARRANTY

nexTouch has a three year limited warranty on the mechanical and electrical components, and a one year limited warranty on the finish.

WINDSTORM

Certified (refer to local codes).  Hurricane



nexTouch Exit Trim



Capacitive Touchscreen



Pushbutton keypad option available

Weather Resistant Seal



Lockout Mode



Low Battery Indication

9V Battery Power Backup

Standard mortise cylinder

Privacy Button

Compatible with a wide range of exit devices, including competitor models (see chart on next page)

EXIT TRIM



How To Order

EXIT TRIM

Quantity	Lever Design	Series/Function	Technology	Finish	Cylinder/Keyway	Hand*	Door Thickness
	AU – Augusta	NTT610 – Exit trim, key override, pushbutton keypad	NR – Keypad only, no radio	605 – Bright brass, clear coated	2153 cylinder keyed random standard, see pages 38-40 for additional options	RHR LHR	1-3/4" 2-1/4"
	MO – Monroe		ZW2 – Z-Wave wireless communication	613E – Dark oxidized bronze - equivalent			
	PB – Pacific Beach	NTT620 – Exit trim, key override, touchscreen keypad		626 – Satin chrome plated			
				BSP – Black suede powder coat			

*Lock is field reversible

BUILD YOUR ORDER STRING

Quantity	Lever Design	Series/Function	Technology	Finish	Cylinder/Keyway	Hand	Door Thickness
<i>Example:</i>	AU	NTT620	NR	626	2153	RHR	1-3/4"

COMPATIBLE EXIT DEVICES

Thanks to its patented adjustable mounting posts, Yale nexTouch exit trim is compatible with several makes and models of exit devices right out of the box, without the need for separate mounting hardware. Check the chart below to see if yours is a fit.

Manufacturer	Model/Series Number*
Arrow	3880
Corbin Russwin	ED5200, ED5200S
Dorma	9300
Falcon®	25
SARGENT	8800
Von Duprin®	98, 99
Yale	1800, 2100/2150, 6100/6150, 7100/7150

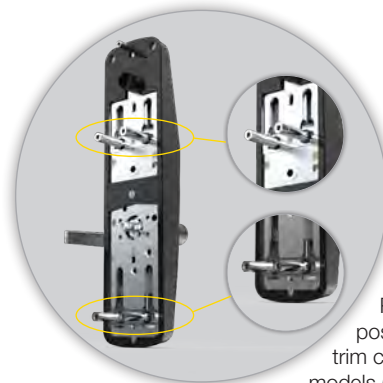

Patented adjustable mounting posts make the nexTouch exit trim compatible with many exit device models (see chart at left).

*Compatible with rim device only. Please contact Technical Product Support for more information.

Trim Designs

EXIT TRIM

AUGUSTA AU*
AU Lever Handle: Cast

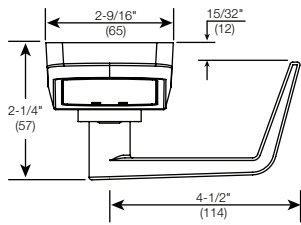

MONROE MO
MO Lever Handle: Cast

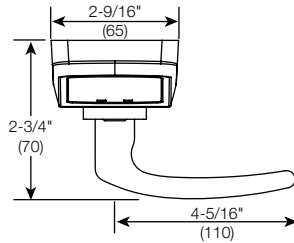

PACIFIC BEACH PB*
PB Lever Handle: Cast

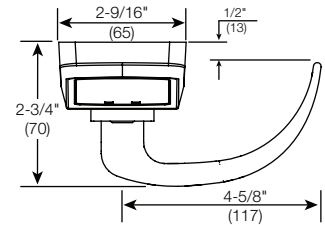





*Meets California State Reference Code for lever return

EXIT TRIM



Finishes

EXIT TRIM

ANSI/BHMA Code Finish Description			
605 Bright Brass, Clear Coated	613E Dark Oxidized Satin Bronze - equivalent	626 Satin Chrome Plated	BSP Black Suede Powder Coat
			

EXIT TRIM



Functions

EXIT TRIM

NTT610 Pushbutton NTT620 Touchscreen

No Deadbolt With Cylinder Override

- For doors that require mechanical key override.
- Bolt retracted by pushbar on interior and lever on outside except when outside lever is locked.
- Key override unlocks the outside lever only.
- Deadlocking rim bolt.

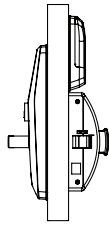

Outside

Inside



Cylinders

EXIT TRIM

Conventional Cylinders

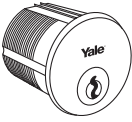
Illustration	Cylinder Model Number	Application	Cam	Length	
				6-Pin	7-Pin
	2153	Standard cylinder	2160	1-1/8"	1-1/4"

*Contact Technical Product Support for cylinder collar requirements when ordering these cylinders separately. See page 41 for other collar requirements.

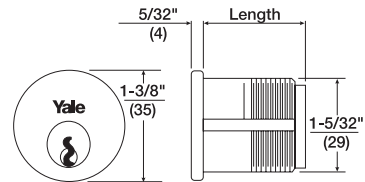

Interchangeable Core Mortise Cylinders

Cylinder Model Number	Application	Cam	Length	Pins	Housing Only Model Number	Core Only Model Number
2196	Standard Cylinder	2160	1-1/2"	6	2221	1210
2197	Standard Cylinder	2160	1-11/16"	7	2213	1220

Note: When ordering interchangeable core cylinders or cores only, control keys are not furnished. If control keys are required they must be ordered separately.

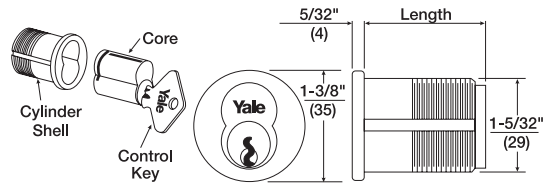

EXIT TRIM

Cylinders

EXIT TRIM (CONTINUED)

Security Cylinders

Security cylinders contain two independent locking mechanisms. The first is a traditional 6- or 7-pin tumbler mechanism with spool drivers for greatly increased picking resistance.

The second is an innovative 5-tumbler rotating disc mechanism with sidebar engagement. The rotating discs are spring loaded and block the bottom of the keyway.

Illustration

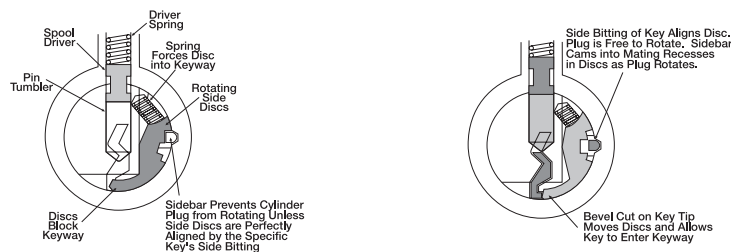

Security/High Security Mortise Cylinders

Model Number	Application	Cam	Length	
			6-pin	7-pin
5153	Standard Cylinder	2160	1-1/8" 1-1/4"	1-1/4"

Security Interchangeable Core Mortise Cylinders

Cylinder Model Number	Application	Cam	Length	Pins	Housing Only Model Number	Core Only Model Number
5196	Standard Cylinder	2160	1-1/2"	6	2221	5210
5197	Standard Cylinder	2160	1-11/16"	7	2213	5220



Note: When ordering interchangeable core cylinders or cores only, control keys are not furnished. If control keys are required they must be ordered separately.



Cylinders

EXIT TRIM (CONTINUED)

Other Manufacturers' Keyway Cylinders/Cores

Illustration	Model Number	Type	Cam	Length	Pins	Housing Only Model Number	Core Only Model Number
	A620	Small Format IC Mortise, includes Best® Keyway Core. Available keyed random, master keyed or uncombined. Specify keyway A, B, C, D, E, F, G, H, J, K, L or M.	KC1	1-1/4"	6	K660	A600
				1-3/8"	6 or 7		
	2553	Fixed Core Mortise Schlage® "C" Keyway Cylinder. Available 0-bitted or keyed random.	2160	1-1/8"	6	N/A	N/A

Yale® KeyMark®

For those applications requiring protected key control, Yale® KeyMark® cylinders guard against unauthorized key duplication. The Yale KeyMark Security Leg® keyway feature increases resistance against picking and impressioning and can easily retrofit into existing systems. For further details and availability, refer to the separate Yale KeyMark catalog.

Protected Keyway Mortise Cylinders

Model Number	Type	Cam	Length	Pins	Housing Only Model Number	Core Only Model Number
K100	Fixed Core Mortise	KC1	1-1/8"	6 or 7	N/A	N/A
K820	Large Format IC Mortise	KC1	1-1/2"	6	K860	K800
			1-11/16"	7		
K620	Small Format IC Mortise	KC1	1-1/4"	6	K660	K600
			1-3/8"	6 or 7		



Cylinder Collars

EXIT TRIM

Cylinder collars are supplied as standard where required with those locksets supplied with cylinders. Collar size and thickness are supplied to suit the length of the cylinder, the thickness of the door and the trim ordered. (If door thickness is not specified, collars will be furnished for 1-3/4" (44mm) door.)

Collar length required must be specified for cylinders and/or housings ordered separately.

1765 Recessed Cylinder Collar

"A" Dimension: Thicknesses from 1/16" (2mm) to 1-15/32" (37mm) as required.

Material: Brass, Stainless Steel

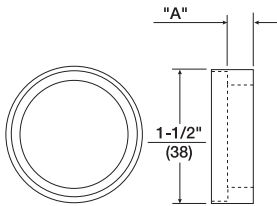



Dimensions

EXIT TRIM

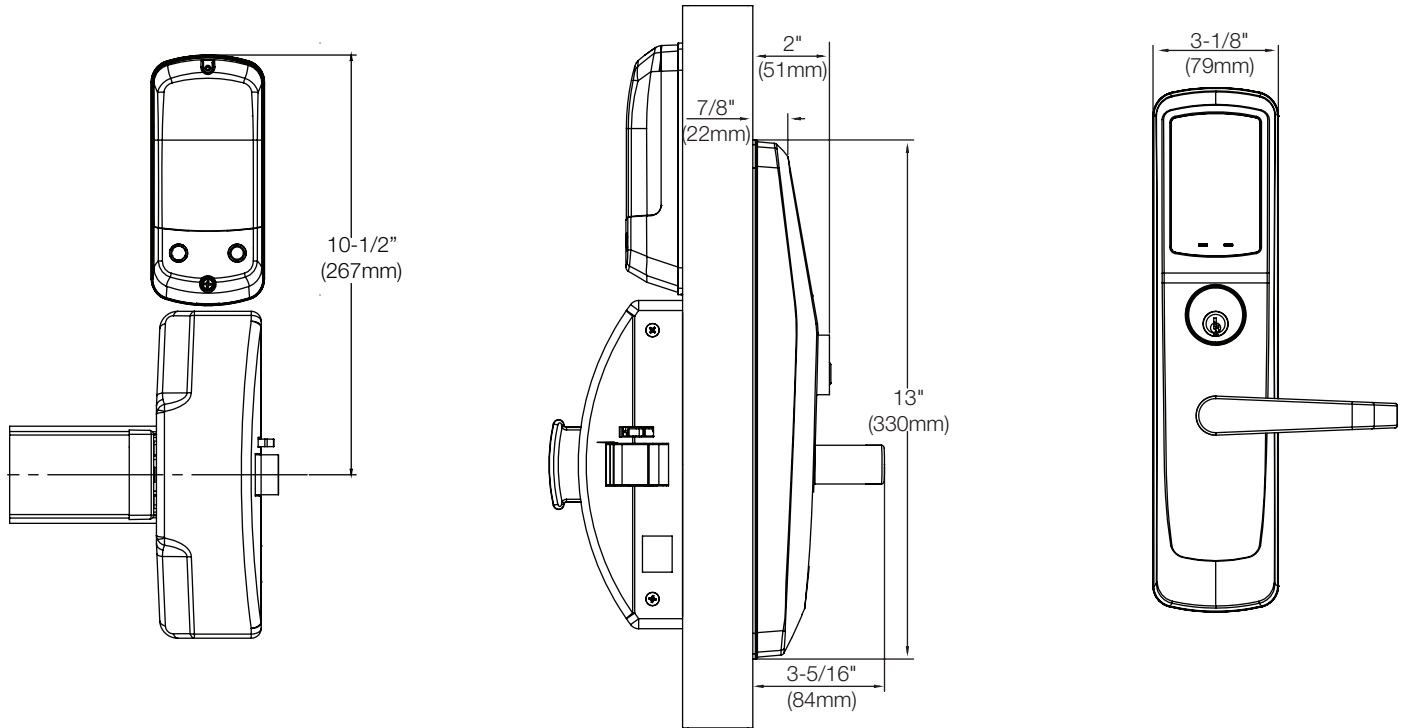

Dimensions given in inches (mm).

EXIT TRIM



Technology Options

EXIT TRIM

NR	Keypad only, no radio
ZW2	Z-Wave wireless communication

Yale Accentra™ Data-on-Card module available only through Authorized Channel Partners. If you require another module not listed in this catalog, please contact your local ASSA ABLOY Door Security Solutions sales representative.



Z-Wave Module



Options and Accessories

EXIT TRIM

Model/Part Number	Description
784	Optional remote 9VDC power supply with plug-in wall transformer (used for hardwiring up to two nexTouch locks).
WH-28	Remote power wire harness (used for hardwiring).

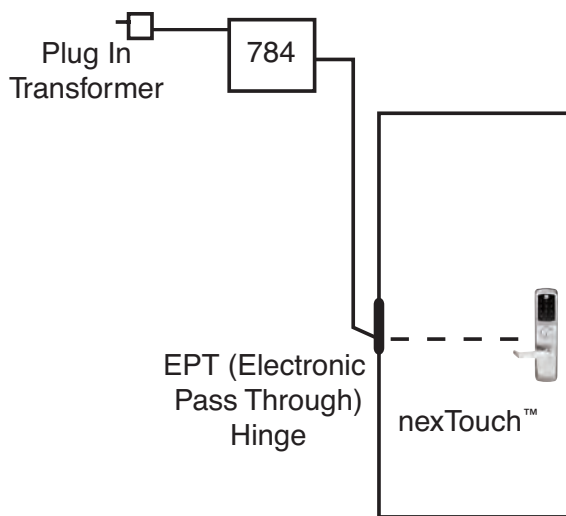

EXIT TRIM



Certifications and Listings

EXIT TRIM

ADA



The nexTouch Series lever design meets accessibility guidelines of the Americans with Disabilities Act and the requirements of the Uniform Federal Accessibility Standards and ICC/ANSI A117.1 Accessible and Usable Buildings and Facilities, all requiring ease of accessibility.

ANSI/BHMA

nexTouch exit trim certified ANSI/BHMA A156.3, Grade 1.

FIRE LISTINGS



Functions are UL/cUL Fire Listed for use on fire doors having a rating up to and including 3 hours.

Note: Any retrofit or other field modification to a fire rated opening can potentially impact the fire rating of the opening, and Yale Locks & Hardware makes no representations or warranties concerning what such impact may be in any specific situation. When retrofitting any portion of an existing fire rated opening, or specifying and installing a new fire-rated opening, please consult with a code specialist or local code official (Authority Having Jurisdiction) to ensure compliance with all applicable codes and ratings.

FCC

Complies with limits for a Class A digital device, pursuant to part 15 of the FCC Rules.

ISO 14001

Designed and manufactured under a certified ISO 14001 quality system.

WARRANTY

nexTouch has a three year limited warranty on the mechanical and electrical components, and a one year limited warranty on the finish.



Notes

EXIT TRIM



Notes

EXIT TRIM

Contact Us

The world's favorite lock



U.S.A.

Yale Locks & Hardware

Address: 225 Episcopal Road
Berlin, CT 06037-4004
Tel: 1-800-438-1951
Fax: 1-800-338-0965
yalelocks.com

Canada:

ASSA ABLOY Door Security Solutions Canada

Address: 160 Four Valley Drive
Vaughan, Ontario L4K 4T9
Tel: 1-800-461-3007
Fax: 1-800-461-8989
assaabloydss.ca

International:

ASSA ABLOY Americas International

Tel: 1-905-821-7775
Fax: 1-905-821-1429
assaabloyai.com

Yale Commercial is a business associated with ASSA ABLOY Access and Egress Hardware Group, Inc., an ASSA ABLOY Group company. Copyright © 2016-2020, ASSA ABLOY Access and Egress Hardware Group, Inc. All rights reserved. Reproduction in whole or in part without the express written permission of ASSA ABLOY Access and Egress Hardware Group, Inc. is prohibited. Patent pending and/or patent www.assaabloydss.com/patents.

YALE, with its unique global reach and range of products, is the world's favorite lock.

ASSA ABLOY is the global leader in door opening solutions, dedicated to satisfying end-user needs for security, safety and convenience.

42915-04/20



Multi-Family Housing

Data-on-Card Access Management Solutions



Contents



Solution Overview		nexTouch Keypad Exit Trim	
System Overview	3	Technical Specifications	37
Features and Benefits	4-5	Features.....	38
Yale Accentra™ Cloud-Based Software		How to Order	39
Features.....	6	Trim Designs	40
Technical Specifications	7	Finishes	41
How to Order	7	Functions.....	42
Credential Updater		Cylinders.....	43-45
Features.....	8	Cylinder Collars	46
Technical Specifications	9	Dimensions.....	47
Credentials		Compatible Exit Devices	47-50
Features.....	10	Options & Accessories.....	51
Technical Specifications	11	Certifications & Listings	52
How to Order	12	Yale Real Living™ Interconnected Lock	
nexTouch™ Cylindrical Lock		Technical Specifications	53
Technical Specifications	13	Features.....	54
Features.....	14	How to Order	55
How to Order	15	Lever Designs, Finishes, and Functions	56
Dimensions and Lever Designs	16	Dimensions and Cylinders.....	57
Functions and Finishes	17	Latchbolts	58
Cylinders.....	18-19	Strikes.....	59
Latchbolts and Strikes	20	Yale Real Living™ Digital Deadbolt	
Options and Accessories.....	21	Technical Specifications	61
Certifications and Listings	22	Features.....	62
nexTouch Sectional Mortise Lock		How to Order and Finishes.....	63
Technical Specifications	23	Cylinders, Thin Door Kit.....	64
Features.....	24	Strikes.....	65
How to Order	25	Latchbolts	66
Trim Designs	26		
Reflections® Decorative Trim	27		
Functions and Finishes	28		
Cylinders.....	29-31		
Cylinder Collars	32		
Strikes.....	33		
Dimensions.....	34		
Options & Accessories.....	35		
Certifications & Listings	36		

Access Control Made Easy



The Yale Multi-Family Solution combines electronic smart locks with intuitive cloud-based software for easy and convenient access management of multi-family, assisted living and mixed-use buildings. The system leverages the social network of your facility to ensure credentials are always up-to-date, without the hassle or cost of wiring every door.

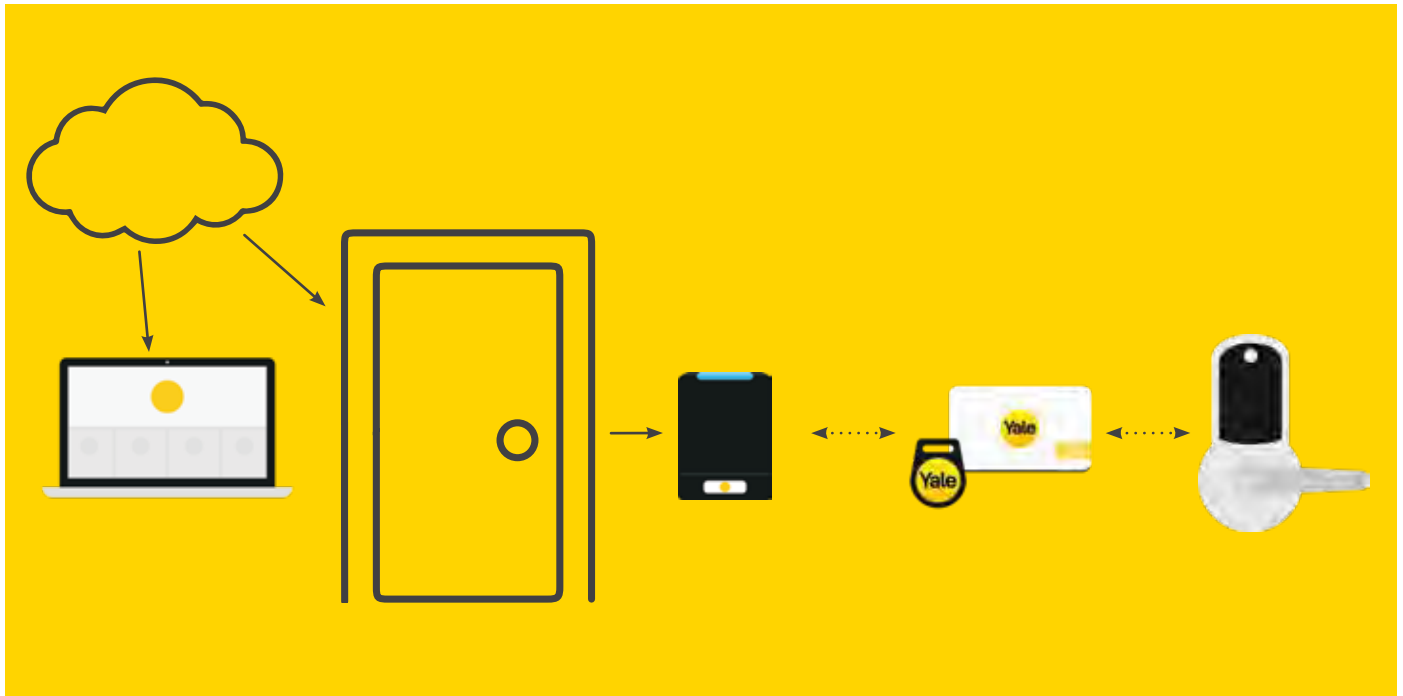

<p>Cloud-based access management at every opening</p>	<p>Manage access remotely for one or multiple sites</p>	<p>Remotely unlock online doors and grant emergency access to offline doors with one-time PIN codes</p>
<p>Intuitive, easy to use software</p>	<p>Eliminates costly key management</p>	<p>Highly encrypted and secure</p>

Manage Access Rights for Residents, Guests & Employees



Yale Accentra™ Cloud-Based Software

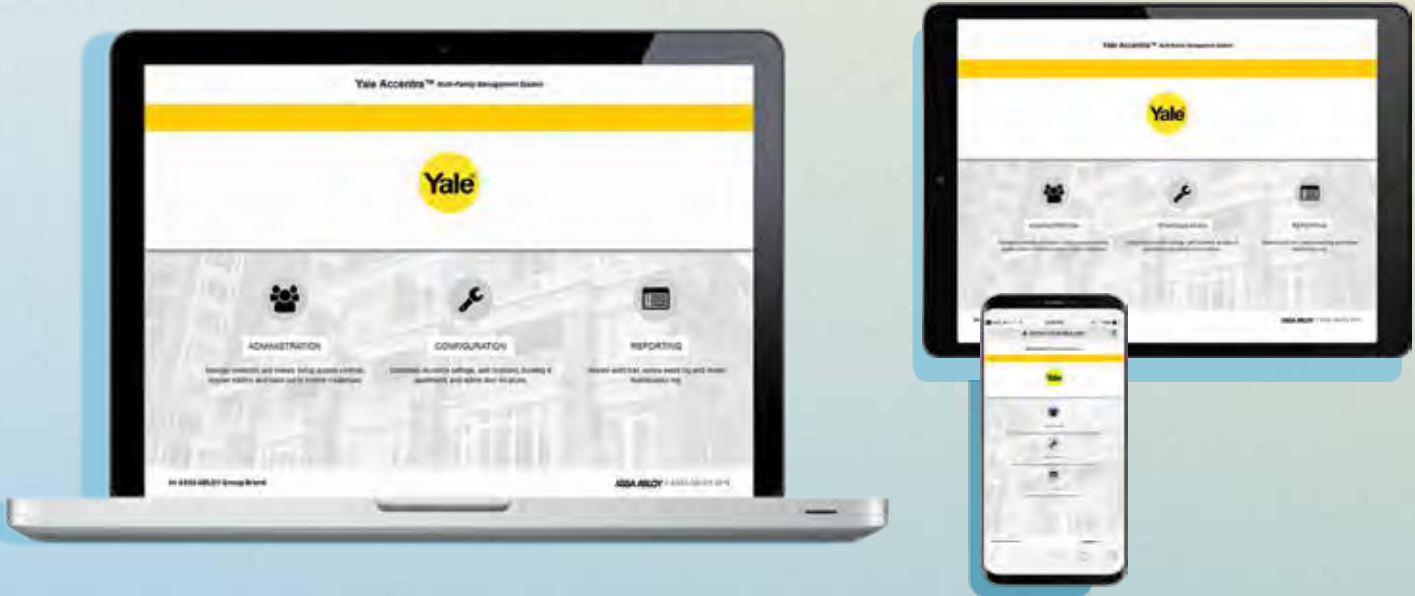

- Eliminates cost and maintenance of on-site servers
- Enables easy management of access rights for residents, guests, and employees
- Intuitive interface optimizes for your device and requires minimal training
- Built around the typical workflows of a multi-family property management office
- Ensures that a facility's database is always accessible and secure
- Enables management of multiple properties and employees with access to multiple sites
- Allows property manager to distribute one-time-PINs for unit lockout or lost cards (emergency access) and remotely unlock offline doors

Technical Specifications

Dedicated web-based interface accessible from any Internet-connected device (Mac, PC, smart phone or tablet)
Responsive design accommodates any device (Mac, PC, smart phone or tablet)
Automatic updates
Certified to ISO/IEC 27001
Browser: Firefox, Chrome, or similar

How to Order



System and Subscription Options

Part Number	Description
ACC-SUB-INIT	Account registration
ACC-SUB-001	Annual software subscription fee per door for systems 1-49 doors
ACC-SUB-050	Annual software subscription fee per door for systems 50-199 doors
ACC-SUB-200	Annual software subscription fee per door for systems 200-499 doors
ACC-SUB-500	Annual software subscription fee per door for systems 500-999 doors
ACC-SUB-01K	Annual software subscription fee per door for systems 1000+ doors

Note: A Yale Accentra™ compatible data-on-card lock cannot be turned on within a system without ordering the appropriate number of subscription units. Subscriptions must be ordered in eches based on the quantity of managed devices within a system.
Ex: 100 locks + 2 online updaters = 102 managed devices.

Yale Multi-Family Solution Online Updater



Update Access Rights
and Transmit Audit Trails



Mini-mullion updater

Wall switch updater

Controller

- Activates new credentials for residents, guests, and staff
- Transmits current access rights to credentials at time of presentation
- Ensures credentials are continuously updated through typical daily use
- Reads audit information including access history, lock battery status, and other lock events from the credential and transmits to Yale Accentra™ cloud service

Used together in a one-to-one relationship, the controller and the credential updater are known as the on-line updater. The on-line updater can operate either as a credential enrollment station or as a single door controller to operate an electrified strike, mag lock, gate operator, activate an elevator call button and more.

Technical Specifications



Credential Updater

Base Part Number	NTX610	NTX640
Typical Read Range	iCLASS Seos: Contact	iCLASS Seos: Contact
Mounting	Mini-Mullion Size; physically HID's smallest iCLASS® readers and are ideally suited for mullion-mounted door installations, U.S. single-gang J-box (with mud ring) or any flat surface	Wall Switch Size; designed to mount and cover single gang switch boxes primarily used in the Americas and includes a slotted mounting plate for European and Asian back box spacing
Dimensions	1.9" x 4.1" x 0.9" 4.8 cm x 10.3 cm x 2.3 cm	3.3" x 4.8" x 1.0" 8.4 cm x 12.2 cm x 2.4 cm
Product Weight (Pigtail)	3.9 oz (113g)	7.7 oz (220g)
Product Weight (Terminal Strip)	2.9 oz (84g)	7.5 oz (215g)
UL Ref Number	R10E	R40E
Operating Voltage Range	5-16 VDC	
Color	Black	
Current Draw - Standard Power Mode2 (mA)	60 @ 16V	
Peak Current Draw - Standard Power	200 @ 16V	
Operating Temperature	-31° to 150° F (-35° to 65° C)	
Operating Humidity	5% to 95% relative humidity non-condensing	
Environmental Rating	Indoor/Outdoor IP55; IP65 if installed with optional gasket	
Transmit Frequency	13.56 MHz	
13.56 MHz Card Compatibility	Secure Identity Object™ (SIO) on iCLASS Seos,	
Communications	Open Supervised Device Protocol (OSPD) via RS485	
Panel Connection	Pigtail or Terminal Strip	
Certifications	UL294/cUL (US), FCC Certification (US), IC (Canada), CE (EU)	
Crypto Processor Hardware Common Criteria Rating	EAL5+	
Housing Material	UL94 Polycarbonate	
Manufactured with % of recycled content (Pigtail)	10.5%	
Manufactured with % of recycled content (Terminal Strip)	11.0%	
Warranty	Limited lifetime	

Controller

Dimensions	7-1/8" x 7-1/8" x 1-3/4" (181mm x 181mm x 45mm)
Power Supply	24VDC or POE (power over Ethernet)
Power Consumption	100mA @ 24VDC
Operating Temperature	40°F (5°C) to 104°F (40°C)
Ethernet	10/100 Mbit/s
Certifications	Certified FCC Part 15
Warranty	1 year

Yale Multi-Family Solution Credentials







- Program each credential for individual users' unique access privileges
- Access rights updated seamlessly as user moves about the building through doors controlled by online updater
- Compatible with existing third-party access control systems that use HID iCLASS SE and multiCLASS SE credential readers
- Customizable graphics available on card credentials

The Yale Multi-Family Solution offers innovative Seos[®] offline key cards and fobs, which allow for highly encrypted and secure transactions of access permissions and audits within the Yale Accentra system. If your building has an existing access control system that uses HID iCLASS SE or multiCLASS SE credential readers, Yale Accentra fobs and key cards can be programmed so users are able to operate all readers, new and existing, with one unique credential.

Technical Specifications



Credentials

				
	Key fob with Seos®	Key card with Seos®	Key card with Seos® and custom graphics	Key card with Seos® and Prox
Part Number	NTX600-YALFOB-8K	NTX600-YALCRD-8K	NTX600-CUSCRD-8K	NTX600-YALPRX-8K
Technology				
Seos Offline	X	X	X	X
Seos Online PACS	X	X	X	X
Prox				X
Dimensions	1.25" x 1.56" x .24" (3.175 x 3.96 x .6 cm)	2.127" x 3.375" x 0.033" max (5.40 x 8.57 x 0.084 cm)		
Formatting	Online PACS Format: U100018, 56 Bit, Site code 20			
Operating Frequency	13.56 MHz with ISO/IEC 14443 Type A			
Typical Maximum Read Range	Contact			
Construction	Composite with 60% PVC / 40% PET			
Operating Temperature	-40° to 158° F (-40° to 70° C)			
Weight	0.20 oz (5.5g)			
Memory Size/Application Areas	iCLASS Seos 8K secure processor			
Privacy Mode	Privacy-preserving mode (with encryption of device identifiers)			
Secure Messaging	EN 14890-1 and 7816 aligned using AES algorithm			
Mutual Authentication Mechanism	Based on ISO/IEC 24727-3 2008 with NIST SP800-56A (for session key derivation)			
Write Endurance	Minimum 500,000 cycles			
Data Retention	Minimum 20 years			
Contact Smart Chip Embeddable	Yes			
Printable	Yes, for cards only (white/white card)			
	Usable with direct imaging and thermal transfer printers (from HID or other suppliers)			
	Exclusion areas for printing may apply in some areas of the card plastic			
Secure Identity Services	Customized cards are available through HID Identity on demand			
Warranty	Lifetime, see complete warranty policy for details			



Credential Updaters

Credential Updater/Controller Kits¹

NTX610-KIT-PT	Contactless smart credential updater (mini-mullion with pig tail) and controller
NTX610-KIT-TS	Contactless smart credential updater (mini-mullion with terminal strip) and controller
NTX640-KIT-PT	Contactless smart credential updater (wall switch with pig tail) and controller
NTX640-KIT-TS	Contactless smart credential updater (wall switch with terminal strip) and controller

1. Credential updater and controller are both required for each online opening.

Credentials

NTX600-YALCRD-8K	Seos card, 8K, Yale branded
NTX600-CUSCRD-8K	Seos card, 8K, custom graphics ²
NTX600-YALPRX-8K	Seos + Prox card, 8K, Yale branded
NTX600-YALFOB-8K	Seos fob, 8K, Yale branded

2. Artwork requirements available upon request. 4-5 week lead time from time of artwork proof approval.

Other Accessories

PoE-BUNDLE	Securitron Power over Ethernet injector and power supply
------------	--

Replacement Parts

Credential Updater Only

NTX610-UPDTR-PT	Contactless smart credential updater (mini-mullion with pig tail)
NTX610-UPDTR-TS	Contactless smart credential updater (mini-mullion with terminal strip)
NTX640-UPDTR-PT	Contactless smart credential updater (wall switch with pig tail)
NTX640-UPDTR-TS	Contactless smart credential updater (wall switch with terminal strip)

Controller

NTX600-CTLR	Controller
-------------	------------



PoE bundle

Control Access to Common Areas and Exterior Doors



nexTouch™ Cylindrical Lock



Technical Specifications

Door Specifications	Fits into the standard ANSI/BHMA A156.115 cylindrical lock with lever door prep with one additional 3/4" hole and 7 screws including latchbolt and strike
Backset	2-3/4" (70mm) standard backset
Door Thickness	1-3/4" (44mm) door thickness standard; thin door kit required for 1-3/8" thick doors
Handing	Non-handed
Latchbolt	1/2" (13mm) throw deadlocking latchbolt supplied standard
Strike	ANSI strike 4-7/8" x 1-1/4" x 1-1/4" (124 mm x 32 mm x 32 mm) lip to center supplied standard
Cylinder	Accepts Yale® fixed core component cylinders; also available to accept small format interchangeable core (SFIC)
Keying	Capable of accepting Yale® 6-pin standard, small and large format interchangeable core, security and protected keyway cylinders with master keying capabilities
Packing	Each box includes a paper door marker, combination wood and machine screws and easy-to-follow installation and programming instructions; cylinder functions supplied with two keys
ANSI/BHMA	Certified ANSI/BHMA A156.2, Series 4000 Grade 1
UL/cUL	Functions are UL - cUL Fire Listed for use on fire doors having a rating up to and including 3-hours
Warranty	1-year electrical warranty; 3-year mechanical and finish warranty
Environmental Specifications	Operating temperature: -40°F to +140°F (-40°C to +60°C) at 95% relative humidity when used with an external power supply
Power Source	4 AA alkaline batteries (included) with optional hardwire input for 9VDC external power; 9V battery power backup
Credentials	Seos™ cards and fobs
Interface	Capacitive touchscreen or pushbutton



Capacitive Touchscreen

Touchscreen shown when activated

Lockout Indicator

Voice Assisted Programming

Low Battery Indicator

Weather Resistant - Gasketed seal allows for outdoor installation of exterior escutcheon



9V Battery Power Backup

Solid Metal Escutcheon - Provides quality and durability

Optional Cylinder/Key Override (Key free also available)



A push button model is also available with durable acrylic, back lit buttons



Privacy Button - Prevents unwanted access from the outside at the touch of a button

How To Order



Quantity	Lever Design	Series	Function	Technology	Finish	Door Thickness	Cylinder	Latch	Strike
#	AU – Augusta PB – Pacific Beach MO – Monroe	NTB – nexTouch	610 – Key override, push button keypad 620 – Key override, capacitive touchscreen 630 – No key override, push button keypad 640 – No key override, capacitive touchscreen	ACC – Data-on-Card	605 – Bright brass, clear coated 613E – Dark oxidized bronze - equivalent 626 – Satin chrome plated BSP - Black suede powder coat	1-3/4"* 1-3/8"	1803-53L – 6-pin cylinder standard, see pages 18-19 for additional options**	694 latchbolt standard, see page 20 for additional options	497 ANSI strike standard, see page 20 for additional options

*1-3/4" door thickness is standard. Doors under 1-3/4" in thickness require a thin door kit. If you specify 1-3/8" door thickness, a thin door kit is provided automatically.

**When ordering SFIC and LFIC cylinders, please use appropriate prefix before lever selection. See page 17 for more information.

Build Your Order String

Quantity	Lever Design	Series	Function	Technology	Finish	Door Thickness	Cylinder	Latch	Strike
Example:	AU	NTB	610	ACC	626	1-3/4"	1803-53L	694	497

Packing

Each box has a paper door marker, combination wood and machine screws, Door Position Switch (DPS), 4 AA alkaline batteries, Allen wrench, lever removal tool and easy-to-follow installation and programming instructions. Cylinder functions supplied with two keys.

Dimensions and Lever Designs





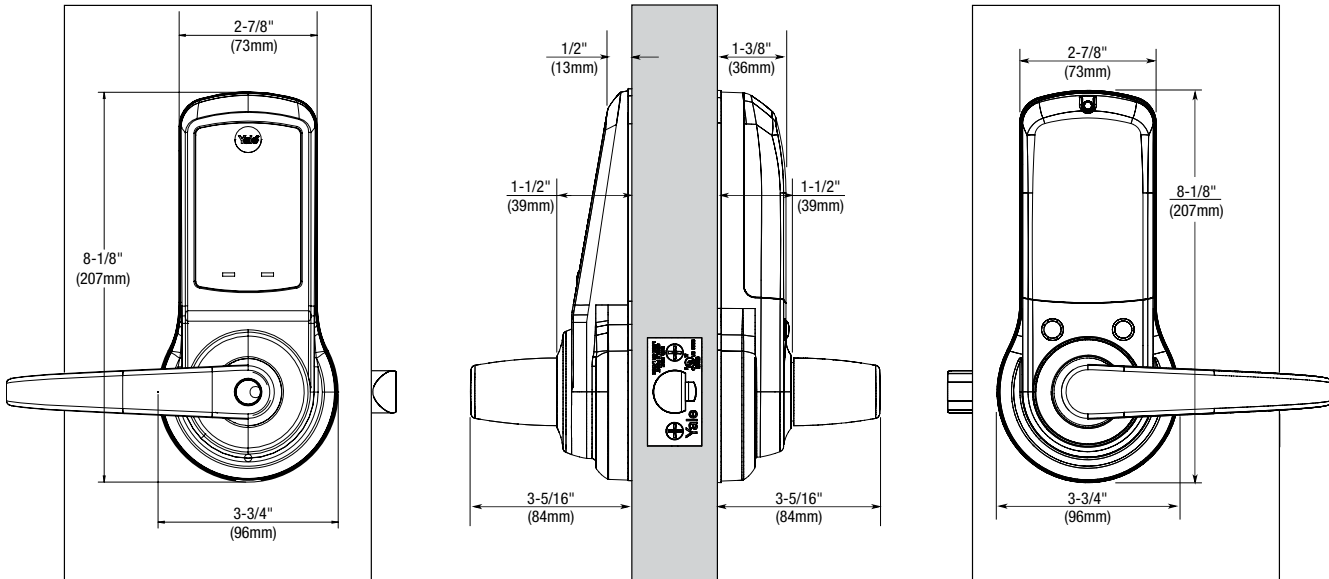



Dimensions



Dimensions given in inches (mm).

Lever Designs

AUGUSTA AU Lever: Cast Zinc 	MONROE MO Lever: Cast Zinc 	PACIFIC BEACH PB Lever: Cast Zinc 
		

 All levers available with small and large format interchangeable core. See pages 18-19 for details.

Functions and Finishes

Functions

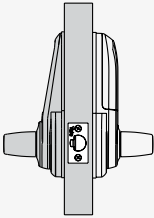
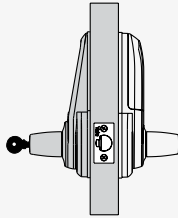
NTB630 Pushbutton NTB640 Touchscreen	NTB610 Pushbutton NTB620 Touchscreen
<p>Without Cylinder Override</p> <ul style="list-style-type: none"> • For doors that do not require mechanical key override. • Latchbolt retracted by lever outside with presentation of valid credential, with valid PIN code, or by operating lever inside. • Inside lever always active. • Deadlocking latchbolt. <div style="text-align: center;">  </div> <p style="text-align: center;">Outside Inside</p>	<p>With Cylinder Override</p> <ul style="list-style-type: none"> • For doors that require mechanical key override. • Latchbolt retracted by lever outside with presentation of valid credential, with valid PIN code, or by operating lever inside. • Inside lever always active. • Deadlocking latchbolt. <div style="text-align: center;">  </div> <p style="text-align: center;">Outside Inside</p>

Lever handles are Free Wheeling in locked position. Shaded area denotes Free Wheeling lever.

Finishes

ANSI/BHMA Code Finish Description			
605 Bright Brass, Clear Coated	613E Dark Oxidized Satin Bronze - equivalent	626 Satin Chrome Plated	BSP Black Suede Powder Coat
			

Cylinders



Cylinder Options

The following selection guide indicates the correct cylinder for each locking segment.

Lockset Series nexTouch™	Types of Cylinder Mechanisms						
	Fixed Core	Conventional		Protected Keyway		Security	
Cylinder Types		6-pin	7-pin	6-pin	7-pin	6-pin	7-pin
Key-In-Lever	1803-53L*	N/A	K403-53L*	N/A	5803-53L*	N/A	
Interchangeable Core							
LFIC	1210	N/A	K800	N/A	5210	N/A	
SFIC	A600	A600	K600	K600	N/A	N/A	

Note: The 1803-53L Cylinder requires an adapter sleeve to fit in the nexTouch lockset. (P/N 14-YM00-9078-999)

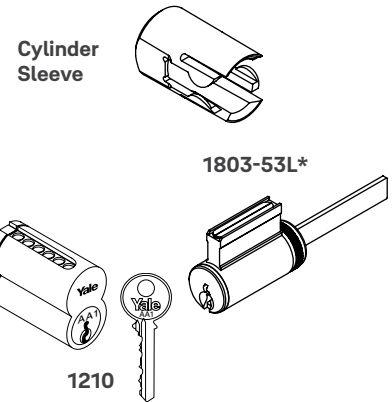

Refer to Yale® KeyMark® and/or Cylinders and Keys Catalog sections for all details and how-to-order examples.

Other Manufacturer Keyway Cylinders

Illustration	Description	Model Number	Number of Pins
	Best® Keyway Cylinder. Available keyed random, master keyed or uncombined. Specify keyway A, B, C, D, E, F, G, H, J, K, L or M.	A600	6 or 7
	Schlage® "C" Keyway. Available 0-bitted or keyed random.	2803-53L*	6
	Corbin Russwin "L4", Corbin "60", Russwin "D1", Sargent® "LA" or Schlage® "E" Keyway. Specify keyway. Available keyed random.	3803-53L*	6
	Arrow "AR"	100CV1	6

***All cylinders require a cylinder sleeve (P/N 14-YM00-9078-999) to fit the nexTouch™ lockset.**



Levers Accepting SFIC And Other Manufacturers' Large Format Interchangeable Cores



Description	Lever Prefix	Number of Pins
SFIC (Accepts all Small Format Interchangeable Cores)	B (i.e. B-AU, B-MO, B-PB)	6 or 7
Corbin Russwin (LFIC)	R (i.e. R-AU)	6
Medeco®, ASSA® (LFIC)	M (i.e. M-AU)**	6
Sargent (LFIC)	SG (i.e. SG-AU, SG-PB)	6
Schlage® (LFIC)	SI (i.e. SI-AU, SI-PB)	6

**Medeco®, ASSA® option available only with AU lever. (Note: For Medeco 32 series cores.)
 LFIC = Large Format Interchangeable Core
 SFIC = Small Format Interchangeable Core

108 Schlage® Cylinder Adapter Kit

Kit used to modify Schlage® cylinder to fit nexTouch™.

P/N 14-5407-9101-999 - 108S

Kit includes tailpiece and sleeve. To order the 108S adapter kit, use an "S" prefix (i.e., S-AU x NTB610).

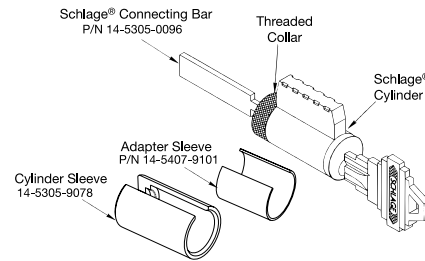

Yale® KeyMark®

For those applications requiring protected key control, Yale® KeyMark® cylinders guard against unauthorized key duplication. The Yale KeyMark Security Leg® keyway feature increases resistance against picking and impressioning and can easily retrofit into existing systems. For further details and availability, refer to the separate Yale KeyMark catalog.

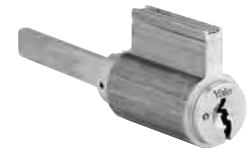



Deadlocking Latchbolts

Model No. 694 supplied standard with all nexTouch™ locksets. Model No. 694 latchbolt has a 2-1/4" x 1-1/8" front with a 2-3/4" backset and a 1/2" bolt throw. Optional latchbolts to special order.

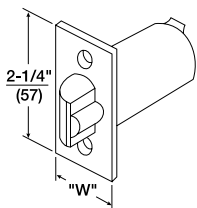

Model No.	Front	Backset	"W" Front Width	Throw	Latch Diameter
694 (standard)	Beveled	2-3/4" (70mm)	1-1/8" (29mm)	1/2" (13mm)	1" (25mm)
F694	Flat	2-3/4" (70mm)	1-1/8" (29mm)	1/2" (13mm)	1" (25mm)
480B	Beveled	2-3/4" (70mm)	1-1/8" (29mm)	3/4" (19mm)	1" (25mm)
F480B	Flat	2-3/4" (70mm)	1-1/8" (29mm)	3/4" (19mm)	1" (25mm)
380N*	Universal	2-3/8" (60mm)	1" (25mm)	1/2" (13mm)	7/8" (22mm)

When ordering latchbolts separately, specify Model No. x Finish (e.g., 694 x 626).

*Using 380N latch results in Grade 2 ANSI/BHMA performance of the lock.

Strikes

Yale® nexTouch™ locksets are available with a variety of strike options. All strikes are located on the same vertical and horizontal center lines as the latchbolt. Some strikes are available in a variety of lip lengths to accommodate varying thickness of doors and frames. To determine the proper length of the lip, measure from the center line of the strike to the edge of the jamb and add 1/4" (6mm). All strikes are reversible.

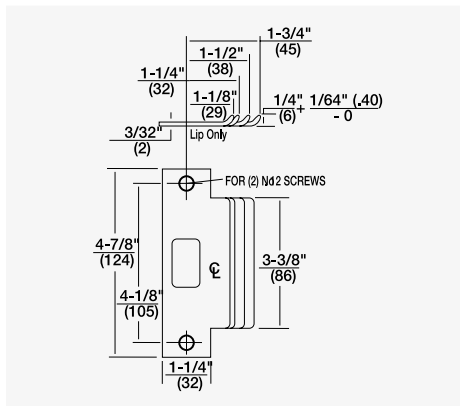

Model No. 497 ANSI Strike (Standard)

For door and frames with ANSI/BHMA A156.115 preparations. 1-1/4" supplied standard. 1-1/8", 1-1/2", and 1-3/4" lip lengths available by special order.

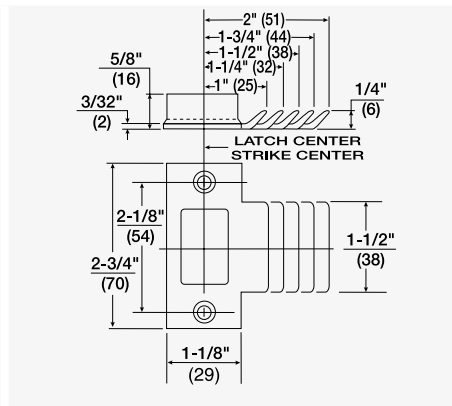

Model No. 371 T-Strike (Optional)

1-1/4" curved lip supplied standard. 1", 1-1/2", 1-3/4", and 2" curved lip lengths available by special order. Wrought strike box supplied.

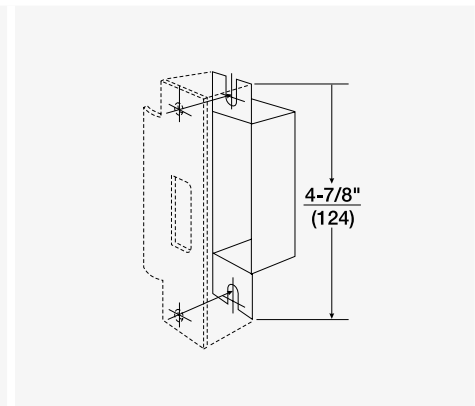

Model No. 202 Strike Box for ANSI Strike (Optional)

Specify 497 x 202

Options and Accessories



Model/Part Number	Description
784	Optional remote 9VDC power supply with plug-in wall transformer (used for hardwiring up to two nexTouch™ locks).
WH-28	Remote unlock and power wire harness (used for hardwiring).
14-4761-0106-025	1-3/8" thin door kit. Includes inside and outside escutcheon spacers as well as a 2-3/8" latchbolt.
NTX600-ACC-KEY	Yale Accentra™ module*

*This technology module can be used to upgrade stand-alone nexTouch locks for use in the Yale multi-family solution by enabling data-on-card technology. This is included when ordering nexTouch locks with ACC in the order string.



Hardwire Option Diagram

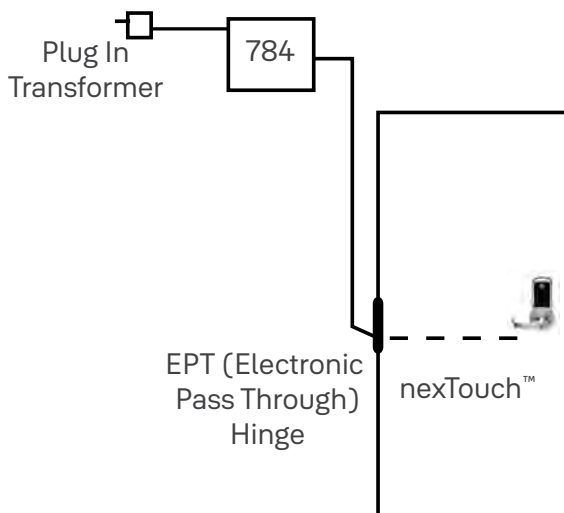

Certifications and Listings



ADA



The nexTouch Series lever design meets accessibility guidelines of the Americans with Disabilities Act and the requirements of the Uniform Federal Accessibility Standards and ICC/ANSI A117.1 Accessible and Usable Buildings and Facilities, all requiring ease of accessibility.

ANSI/BHMA



nexTouch cylindrical certified ANSI/BHMA A156.2, Series 4000 Grade 1.

Fire Listings



Functions are UL/cUL Fire Listed for use on fire doors having a rating up to and including 3 hours.

Note: Any retrofit or other field modification to a fire rated opening can potentially impact the fire rating of the opening, and Yale Locks & Hardware makes no representations or warranties concerning what such impact may be in any specific situation. When retrofitting any portion of an existing fire rated opening, or specifying and installing a new fire-rated opening, please consult with a code specialist or local code official (Authority Having Jurisdiction) to ensure compliance with all applicable codes and ratings.

FCC

Complies with limits for a Class B digital device, pursuant to part 15 of the FCC Rules.

ISO 14001

Designed and manufactured under a certified ISO 14001 quality system.

Sustainability

EPD and GreenCircle certification.

Warranty

nexTouch has a three year limited warranty on the mechanical and electrical components, and a one year limited warranty on the finish.

Windstorm

Certified (refer to local codes).





Control Access to Common Areas and Exterior Doors

nexTouch™ Sectional Mortise Lock



Technical Specifications

Door Specifications	Fits into the standard mortise door prep
Backset	2-3/4" (70mm) standard backset
Door Thickness	1-3/4" (44mm) door thickness standard; please specify for other door thicknesses
Handing	Field reversible
Latchbolt	3/4" spring latchbolt standard, 1" throw deadlocking latchbolt optional
Strike	Curved lip strike with 1-1/4" (32 mm) lip length standard
Cylinder	Accepts conventional, interchangeable core, security and high security cylinders, and other manufacturers' keyway cylinders
ANSI/BHMA	Certified ANSI/BHMA Grade 1
UL/cUL	Functions are UL - cUL Fire Listed for use on fire doors having a rating up to and including 3-hours
Warranty	1-year electrical warranty; 3-year mechanical and finish warranty
Environmental Specifications	Operating temperature: -40°F to +140°F (-40°C to +60°C) at 95% relative humidity when used with an external power supply
Power Source	4 AA alkaline batteries (included) with optional hardwire input f or 9VDC external power; 9V battery power backup on keypad
Credentials	Yale Seos™ cards and fobs
Interface	Capacitive touchscreen or pushbutton keypad

Weather Resistant Seal

Weather Resistant Seal

Touchscreen shown when activated



Lockout Mode



Low Battery Indication

9V Battery Power Backup

Optional Security Deadbolt

Built-in Door Position Sensor/ Deadlocking Function

Reflections® decorative lever options available



A push button model is also available with durable acrylic, back lit buttons

How To Order



Quantity	Lever Design	Series	Function	Technology	Finish	Hand	Door Thickness	Cylinder	Strike
	AUR – Augusta MOR – Monroe	NTM nexTouch mortise	610 – Key override, pushbutton keypad	ACC – Data- on-Card	605 Bright brass, clear coated	RH LH	1-3/4" standard, up to 2-1/4" door thickness available	2153 cylinder standard, see pages 29-31 for additional options	2815 curved lip strike standard, see page 33 for additional options
	PBR – Pacific Beach		615 – Key override, pushbutton keypad, with deadbolt		613E Dark oxidized bronze - equivalent				
	ARR – Arcadia		620 – Key override, capacitive touchscreen		626 Satin chrome plated				
	CRR – Carmel		625 – Key override, capacitive touchscreen, with deadbolt		BSP Black suede powder coat				
	JNR – Jefferson		630 – No key override, pushbutton keypad						
	PNR – Pinehurst		635 – No key override, no deadbolt, pushbutton keypad						
	VIR – Virginia		640 – No key override, capacitive touchscreen						
	See page 27 for Reflections decorative lever options		645 – No key override, no deadbolt, capacitive touchscreen						

Build Your Order String

Quantity	Lever Design	Series	Function	Technology	Finish	Hand	Door Thickness	Cylinder	Strike
Example:	AUR	NTM	620	ACC	626	RH	1-3/4	2153	2815



AUGUSTA AUR
AU Lever Handle: Cast

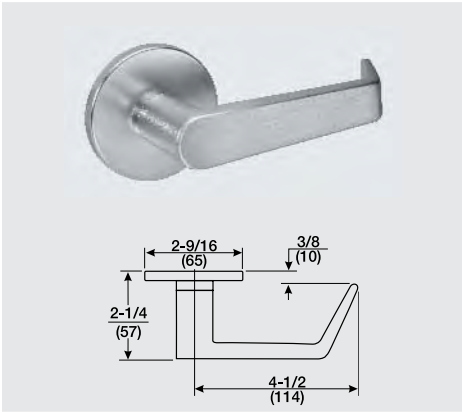

MONROE MOR
MO Lever Handle: Cast

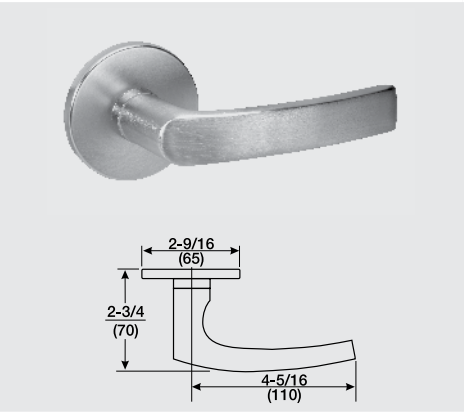

PACIFIC BEACH PBR
PB Lever Handle: Cast

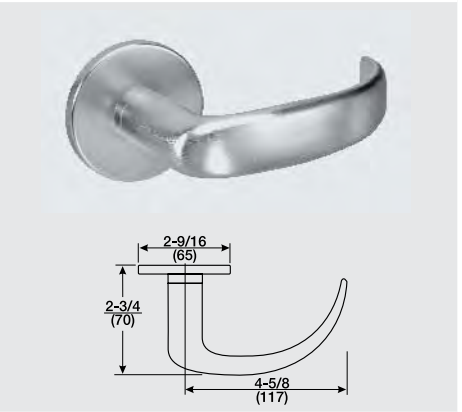

ARCADIA ARR
AR Lever Handle: Cast

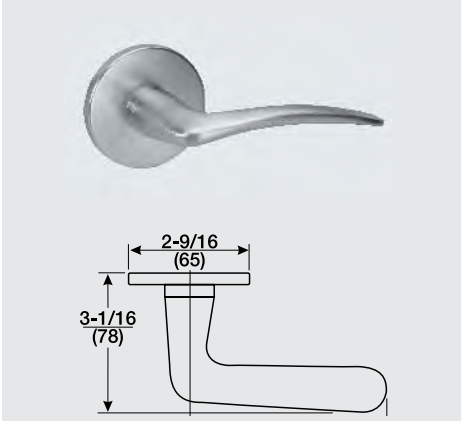

CARMEL CRR
CR Lever Handle: Cast

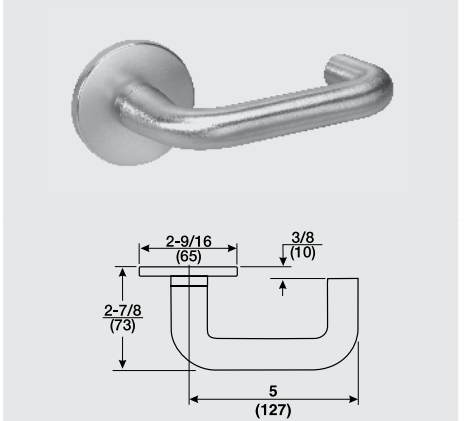

JEFFERSON JNR
JN Lever Handle: Cast

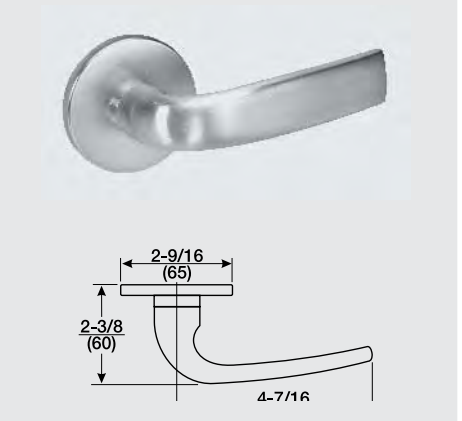

PINEHURST PNR
PN Lever Handle: Cast

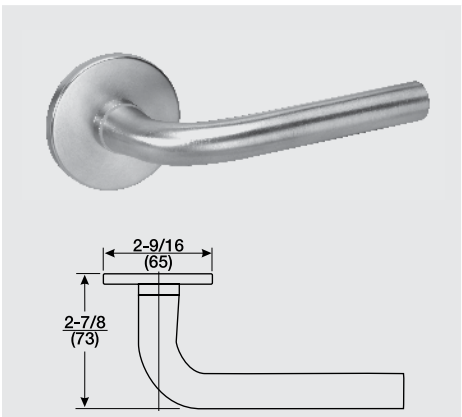

VIRGINIA VIR
VI Lever Handle: Cast

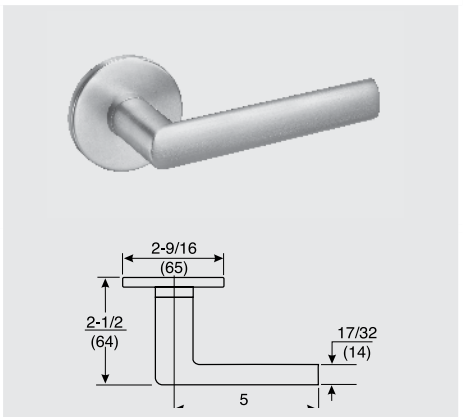

Reflections® Decorative Trim



Yale nexTouch sectional mortise locks are available with Reflections lever trim, a comprehensive line of highly stylized lever handles. Reflections lever handles are made from solid brass or stainless steel and can withstand years of abuse. Available in an array of finishes, these levers complement any wood grain or other door exterior. Each lever is hand-polished and specially designed for ergonomics and style.

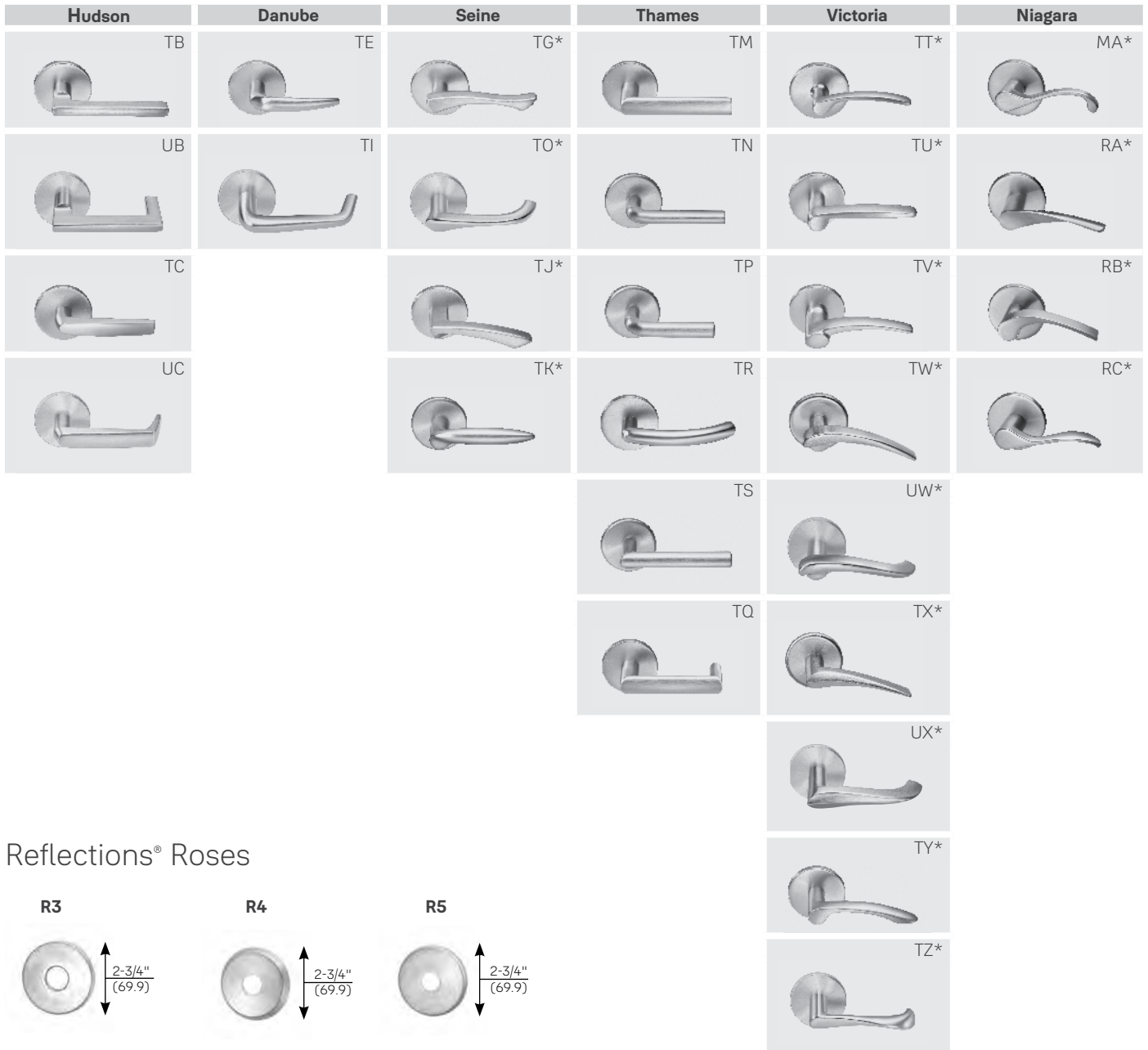

Reflections® Roses

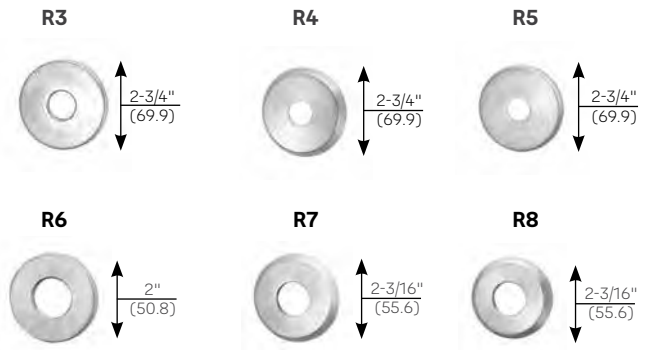

*Indicates levers that are handed.



Functions

**NTM630 Pushbutton
NTM640 Touchscreen**

No Deadbolt Without Cylinder Override

- For doors that do not require mechanical key override.
- Latchbolt retracted by lever either side, except when outside lever is locked
- Deadlocking latchbolt.

Outside Inside

**NTM610 Pushbutton
NTM620 Touchscreen**

No Deadbolt With Cylinder Override

- For doors that require mechanical key override.
- Latchbolt retracted by lever either side, except when outside lever is locked.
- When outside lever is locked, latchbolt is operated by key outside.
- Deadlocking latchbolt.

Outside Inside

**NTM635 Pushbutton
NTM645 Touchscreen**

Deadbolt without cylinder override

- Latchbolt retracted by lever either side, except when outside lever is locked.
- Deadbolt operated by thumbturn inside.
- When deadbolt is projected, lever is automatically locked.
- Anti-panic operation. Operating inside lever automatically retracts latch bolt and deadbolt with outside lever remaining locked.
- Deadlocking latchbolt.

Outside Inside

**NTM615 Pushbutton
NTM625 Touchscreen**

Deadbolt with cylinder override

- Latchbolt retracted by lever either side, except when outside lever is locked.
- Deadbolt operated by key outside, thumbturn inside.
- When outside lever is locked, latchbolt and deadbolt are operated by key outside.
- When deadbolt is projected, lever is automatically locked.
- Anti-panic operation. Operating inside lever automatically retracts latchbolt and deadbolt with outside lever remaining locked.
- Deadlocking latchbolt.

Outside Inside

Finishes

ANSI/BHMA Code Finish Description			
605 Bright Brass, Clear Coated	613E Dark Oxidized Satin Bronze - equivalent	626 Satin Chrome Plated	BSP Black Suede Powder Coat

Cylinders

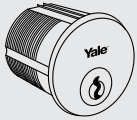

Conventional Cylinders

Illustration	Cylinder Model Number	Application	Cam	Length	
				6-Pin	7-Pin
	2153	Standard cylinder	2160	1-1/8" 1-1/4" 1-3/8"	1-1/4" 1-3/8"
	2153S	For inside operation of 8817-2 and 8834-2 functions only	2130	1-1/2" 1-5/8" 1-3/4"	1-1/2" 1-5/8" 1-3/4"
	2123	Cylinder for longer lengths	2160	1-7/8" thru 3-1/2" in 1/8" increments*	
	2123S	For inside operation of 8817-2 and 8834-2 functions only for longer lengths	2130		
	2719	For hotel/motel locks 8820, 8827 and 8832	2160	1-3/8"	—

*Contact Technical Product Support for cylinder collar requirements when ordering these cylinders separately.

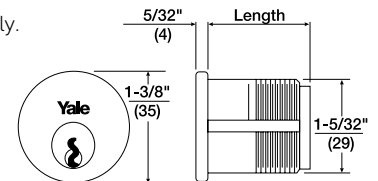

Interchangeable Core Mortise Cylinders

Cylinder Model Number	Application	Cam	Length	Pins	Housing Only Model Number	Core Only Model Number
2196	Standard Cylinder	2160	1-1/2", 1-3/4", 2"	6	2221	1210
2197	Standard Cylinder	2160	1-11/16", 2"	7	2213	1220

Note: When ordering interchangeable core cylinders or cores only, control keys are not furnished. If control keys are required they must be ordered separately.

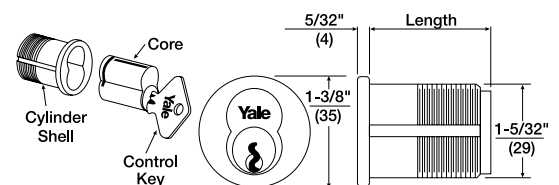

Security Cylinders

Security cylinders contain two independent locking mechanisms. The first is a traditional 6- or 7-pin tumbler mechanism with spool drivers for greatly increased picking resistance.

The second is an innovative 5-tumbler rotating disc mechanism with sidebar engagement. The rotating discs are spring loaded and block the bottom of the keyway.

Illustration

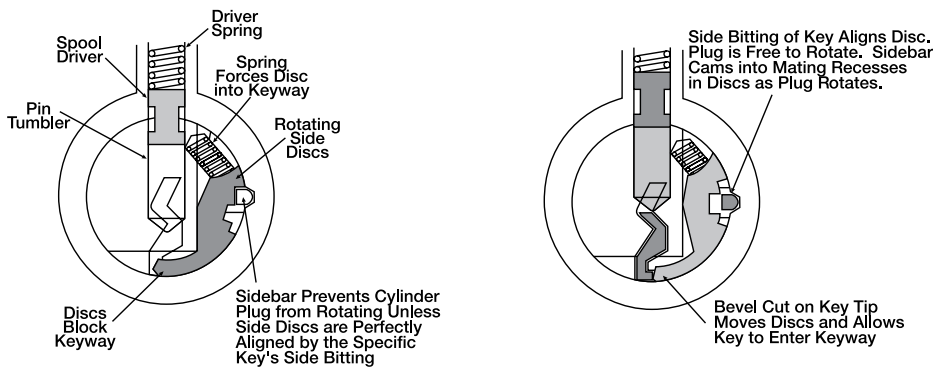

Security/High Security Mortise Cylinders

Model Number	Application	Cam	Length	
			6-pin	7-pin
5153/U5153	Standard Cylinder	2160	1-1/8" 1-1/4"	1-1/4"

Security Interchangeable Core Mortise Cylinders

Cylinder Model Number	Application	Cam	Length	Pins	Housing Only Model Number	Core Only Model Number
5196	Standard Cylinder	2160	1-1/2"	6	2221	5210
5197	Standard Cylinder	2160	1-11/16"	7	2213	5220

Note: When ordering interchangeable core cylinders or cores only, control keys are not furnished. If control keys are required they must be ordered separately.

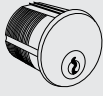

Other Manufacturers' Keyway Cylinders/Cores

Illustration	Model Number	Type	Cam	Length	Pins	Housing Only Model Number	Core Only Model Number
	A620	Small Format IC Mortise, includes Best® Keyway Core. Available keyed random, master keyed or uncombined. Specify keyway A, B, C, D, E, F, G, H, J, K, L or M.	KC1	1-1/4"	6	K660	A600
				1-3/8" 1-3/4"	6 or 7		
	2553	Fixed Core Mortise Schlage® "C" Keyway Cylinder. Available 0-bitted or keyed random.	2160	1-1/8"	6	N/A	N/A

Yale® KeyMark®

For those applications requiring protected key control, Yale® KeyMark® cylinders guard against unauthorized key duplication. The Yale KeyMark Security Leg® keyway feature increases resistance against picking and impressioning and can easily retrofit into existing systems. For further details and availability, refer to the separate Yale KeyMark catalog.

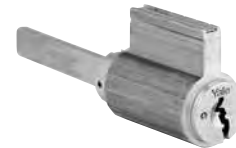

Protected Keyway Mortise Cylinders

Model Number	Type	Cam	Length	Pins	Housing Only Model Number	Core Only Model Number
K100	Fixed Core Mortise	KC1	1-1/8", 1-1/4" 1-1/2", 1-3/4" 2"	6 or 7	N/A	N/A
K820	Large Format IC Mortise	KC1	1-1/2", 1-3/4" 2"	6	K860	K800
			1-11/16" 1-3/4", 2"	7		
K620	Small Format IC Mortise	KC1	1-1/4"	6	K660	K600
			1-3/8", 1-3/4"	6 or 7		
K630	Small Format IC Mortise-Tapered	KC1	1-1/4"	6	K670	K600
			1-3/8"	6 or 7		

Cylinder Collars



Cylinder collars are supplied as standard where required with those locksets supplied with cylinders. Collar size and thickness are supplied to suit the length of the cylinder, the thickness of the door and the trim ordered. (If door thickness is not specified, collars will be furnished for 1-3/4" (44mm) door.)

Collar length required must be specified for cylinders and/or housings ordered separately.

1765 Recessed Cylinder Collar

"A" Dimension: Thicknesses from 1/16" (2mm) to 1-15/32" (37mm) as required.

Material: Brass, Stainless Steel

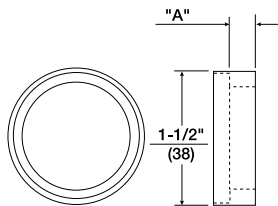

1766 Step Collar for U5109 and U5153 High Security Cylinders.

Material: Stainless Steel

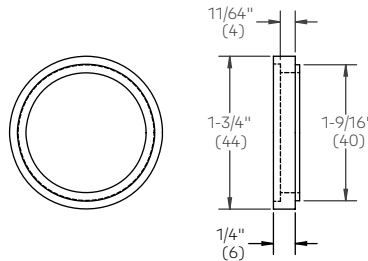

KP3 Wave Washer

(Furnished standard with 1765 collar for Yale® KeyMark® cylinders only).



KP4 Flush Mount Cylinder Collar

Material: Brass, Bronze

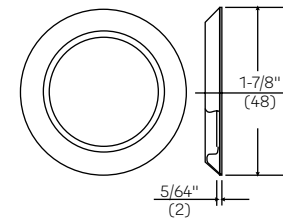

Strikes



Yale nexTouch Keypad Sectional Mortise Locks come standard with a 2815 Curved Lip Strike with a 1-1/4" (32mm) lip length. The strike supplied will accommodate the locking function, i.e. latchbolt and/or deadbolt, and can be installed on doors 1-3/4" (44mm) thick. These strikes are non-handed.

Material: Brass, Bronze, Stainless Steel.

Longer/Shorter Lip Lengths: Mortise lock strikes are mounted 3/8" above the center line of the lock. To determine the proper length of lip use the following formula:

1/2 of the door thickness, plus 1/16" inset, plus trim thickness, plus 1/8" for flat lip strike OR 1/4" for curved lip strike. Select the nearest available length.

2815 Curved Lip:

1-1/4" (32mm) standard
Available for special order:

1-1/8" (29mm)

1-3/8" (35mm)

1-1/2" (38mm)

1-5/8" (41mm)

1-3/4" (44mm)

1-7/8" (48mm)

2" (51mm)

2-1/8" (54mm)

2-1/4" (57mm)

2816 Flat Lip (Available for special order only):

7/8" (22mm)

1" (25mm)

1-1/8" (29mm)

1-1/4" (32mm)

1-1/2" (38mm)

1-3/4" (44mm)

2" (51mm)

2-1/4" (57mm)

2-1/2" (64mm)

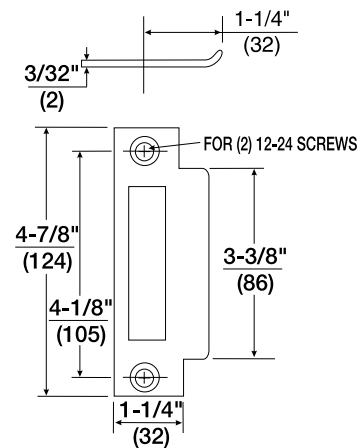

2815 Curved Lip Strike
(1-1/4"/32mm standard)

Dimensions

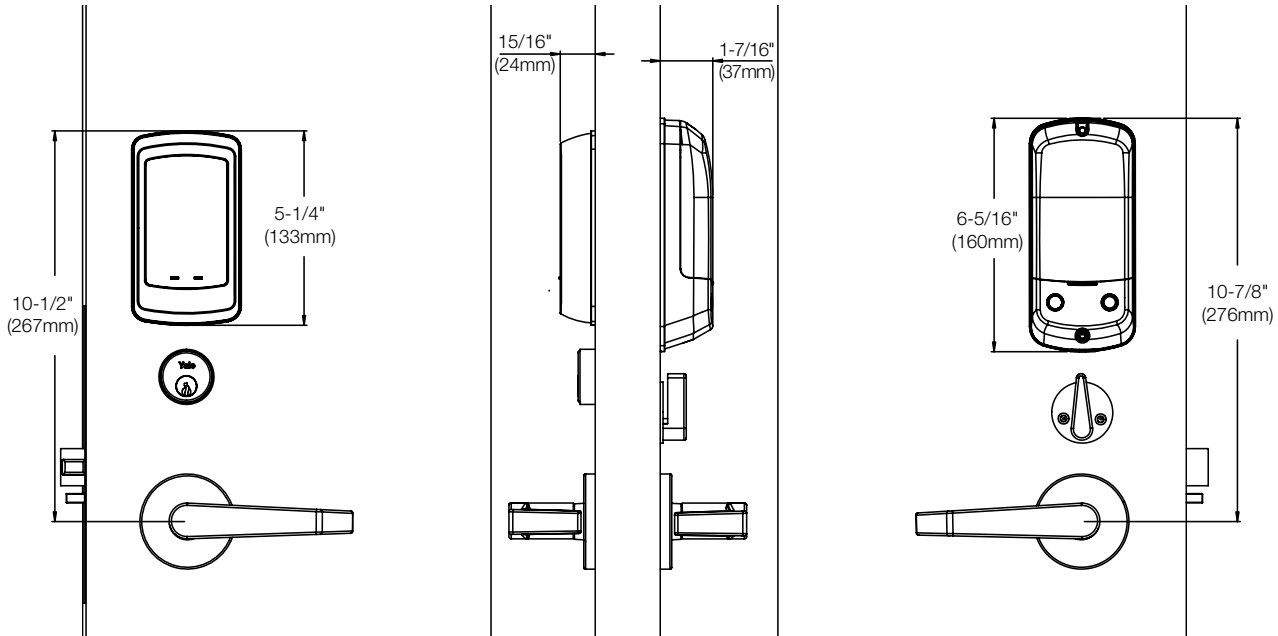

Options & Accessories



Model/Part Number	Description
784	Optional remote 9VDC power supply with plug-in wall transformer (used for hardwiring up to two nexTouch™ locks).
WH-28	Remote unlock and power wire harness (used for hardwiring).
14-4761-0106-025	1-3/8" thin door kit. Includes inside and outside escutcheon spacers as well as a 2-3/8" latchbolt.
NTX600-ACC-KEY	Yale Accentra™ module*

* This technology module can be used to upgrade stand-alone nexTouch locks for use in the Yale multi-family solution by enabling data-on-card technology. This is included when ordering nexTouch locks with ACC in the order string.



Hardwire Option Diagram

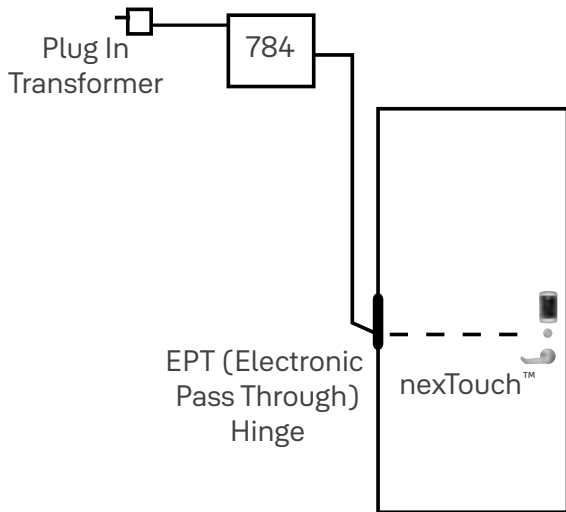

Model/Part Number	Description
50-M600-0150-033	Scar plate, inside without thumbturn
50-M600-0151-033	Scar plate, inside with thumbturn
50-M600-0152-033	Scar plate, inside with cylinder
50-M600-0153-033	Scar plate, inside without cylinder

Certifications and Listings



ADA



The nexTouch Series lever design meets accessibility guidelines of the Americans with Disabilities Act and the requirements of the Uniform Federal Accessibility Standards and ICC/ANSI A117.1 Accessible and Usable Buildings and Facilities, all requiring ease of accessibility.

FCC

Complies with limits for a Class B digital device, pursuant to part 15 of the FCC Rules.

ISO 14001

Designed and manufactured under a certified ISO 14001 quality system.

ANSI/BHMA

nexTouch mortise certified ANSI/BHMA A156.13, Series 1000 Grade 1.



Sustainability

EPD and GreenCircle certification.

Fire Listings



Functions are UL/cUL Fire Listed for use on fire doors having a rating up to and including 3 hours.

Note: Any retrofit or other field modification to a fire rated opening can potentially impact the fire rating of the opening, and Yale Locks & Hardware makes no representations or warranties concerning what such impact may be in any specific situation. When retrofitting any portion of an existing fire rated opening, or specifying and installing a new fire-rated opening, please consult with a code specialist or local code official (Authority Having Jurisdiction) to ensure compliance with all applicable codes and ratings.

Warranty

nexTouch has a three year limited warranty on the mechanical and electrical components, and a one year limited warranty on the finish.

Windstorm

Certified (refer to local codes).



Hurricane

Control Exterior Door and Stairwell Access



nexTouch™ Keypad Exit Trim



Technical Specifications

Door Specifications	Retrofits onto many exit device models, see chart above
Door Thickness	1-3/4" (44mm) door thickness standard, 2-1/4" also available
Handing	Field reversible
Cylinder	Accepts conventional, interchangeable core, security and high security cylinders, and other manufacturers' keyway cylinders
Keying	Capable of accepting Yale 6-pin standard, small and large format interchangeable core, security and protected keyway cylinders with master keying capabilities
ANSI/BHMA	Certified ANSI/BHMA A156.3, Grade 1
UL/cUL	Functions are UL - cUL Fire Listed for use on fire doors having a rating up to and including 3-hours
Warranty	3 year electronic and mechanical warranty, 1 year finish warranty
Environmental Specifications	Operating temperature: -40°F to +140°F (-40°C to +60°C) at 95% relative humidity when used with an external power supply
Power Source	4 AA alkaline batteries (included) with optional hardwire input for 9VDC external power; 9V battery power backup
Credentials	Seos™ cards and fobs
Interface	Capacitive touchscreen or pushbutton



Capacitive Touchscreen

Weather Resistant Seal

 Lockout Mode

 Low Battery Indication

9V Battery Power Backup

Standard mortise cylinder



Pushbutton keypad option available

Compatible with a wide range of exit devices, including competitor models (see chart on page 45)



Privacy Button

How To Order



Exit Trim

Quantity	Lever Design	Series/Function	Technology	Finish	Cylinder/Keyway	Hand*	Door Thickness
	AU – Augusta MO – Monroe PB – Pacific Beach	NTT610 – Exit trim, key override, pushbutton keypad NTT620 – Exit trim, key override, touchscreen keypad	ACC - Data-on-Card	605 – Bright brass, clear coated 613E – Dark oxidized bronze - equivalent 626 – Satin chrome plated BSP – Black suede powder coat	2153 cylinder keyed random standard, see pages 43-45 for additional options	RHR LHR	1-3/4" 2-1/4"

*Lock is field reversible

Build Your Order String

Quantity	Lever Design	Series/Function	Technology	Finish	Cylinder/Keyway	Hand	Door Thickness
Example:	AU	NTT620	ACC	626	2153	RHR	1-3/4"



Exit Trim

AUGUSTA AU* AU Lever Handle: Cast	MONROE MO MO Lever Handle: Cast	PACIFIC BEACH PB* PB Lever Handle: Cast

*Meets California State Reference Code for lever return

Finishes



Exit Trim

ANSI/BHMA Code Finish Description			
605 Bright Brass, Clear Coated	613E Dark Oxidized Satin Bronze - equivalent	626 Satin Chrome Plated	BSP Black Suede Powder Coat
			



Exit Trim

NTT610 Pushbutton NTT620 Touchscreen

No Deadbolt With Cylinder Override

- For doors that require mechanical key override.
- Bolt retracted by pushbar on interior and lever on outside except when outside lever is locked.
- Key override unlocks the outside lever only.
- Deadlocking rim bolt.

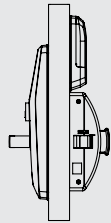

Outside

Inside

Cylinders



Exit Trim

Conventional Cylinders

Illustration	Cylinder Model Number	Application	Cam	Length	
				6-Pin	7-Pin
	2153	Standard cylinder	2160	1-1/8"	1-1/4"

*Contact Technical Product Support for cylinder collar requirements when ordering these cylinders separately.

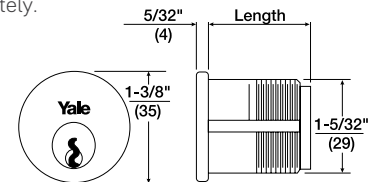

Interchangeable Core Mortise Cylinders

Cylinder Model Number	Application	Cam	Length	Pins	Housing Only Model Number	Core Only Model Number
2196	Standard Cylinder	2160	1-1/2"	6	2221	1210
2197	Standard Cylinder	2160	1-11/16"	7	2213	1220

Note: When ordering interchangeable core cylinders or cores only, control keys are not furnished. If control keys are required they must be ordered separately.

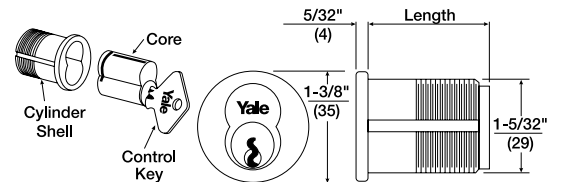

Exit Trim (Continued)

Security Cylinders

Security cylinders contain two independent locking mechanisms. The first is a traditional 6- or 7-pin tumbler mechanism with spool drivers for greatly increased picking resistance.

The second is an innovative 5-tumbler rotating disc mechanism with sidebar engagement. The rotating discs are spring loaded and block the bottom of the keyway.

Illustration

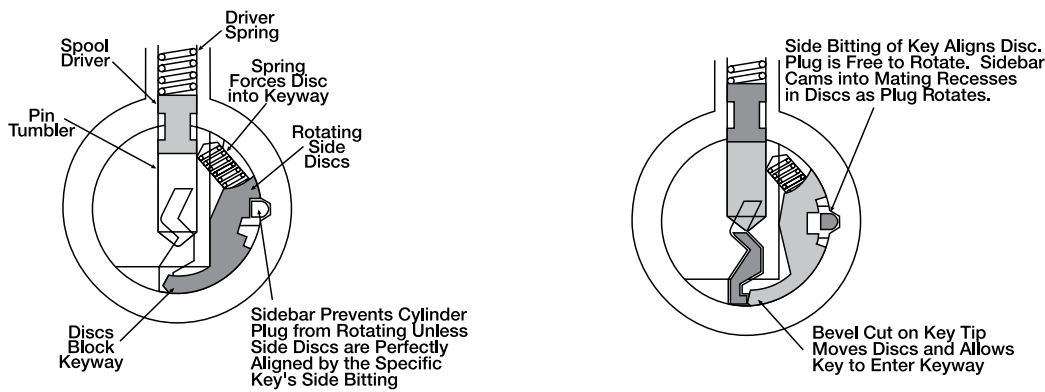

Security/High Security Mortise Cylinders

Model Number	Application	Cam	Length	
			6-pin	7-pin
5153	Standard Cylinder	2160	1-1/8" 1-1/4"	1-1/4"

Security Interchangeable Core Mortise Cylinders

Cylinder Model Number	Application	Cam	Length	Pins	Housing Only Model Number	Core Only Model Number
5196	Standard Cylinder	2160	1-1/2"	6	2221	5210
5197	Standard Cylinder	2160	1-11/16"	7	2213	5220

Note: When ordering interchangeable core cylinders or cores only, control keys are not furnished. If control keys are required they must be ordered separately.



Exit Trim (Continued)

Other Manufacturers' Keyway Cylinders/Cores

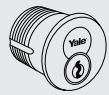
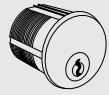
Illustration	Model Number	Type	Cam	Length	Pins	Housing Only Model Number	Core Only Model Number
	A620	Small Format IC Mortise, includes Best® Keyway Core. Available keyed random, master keyed or uncombined. Specify keyway A, B, C, D, E, F, G, H, J, K, L or M.	KC1	1-1/4"	6	K660	A600
				1-3/8"	6 or 7		
	2553	Fixed Core Mortise Schlage® "C" Keyway Cylinder. Available 0-bitted or keyed random.	2160	1-1/8"	6	N/A	N/A

Yale® KeyMark®

For those applications requiring protected key control, Yale® KeyMark® cylinders guard against unauthorized key duplication. The Yale KeyMark Security Leg® keyway feature increases resistance against picking and impressioning and can easily retrofit into existing systems. For further details and availability, refer to the separate Yale KeyMark catalog.

Protected Keyway Mortise Cylinders

Model Number	Type	Cam	Length	Pins	Housing Only Model Number	Core Only Model Number
K100	Fixed Core Mortise	KC1	1-1/8"	6 or 7	N/A	N/A
K820	Large Format IC Mortise	KC1	1-1/2"	6	K860	K800
			1-11/16"	7		
K620	Small Format IC Mortise	KC1	1-1/4"	6	K660	K600
			1-3/8"	6 or 7		

Cylinder Collars



Exit Trim

Cylinder collars are supplied as standard where required with those locksets supplied with cylinders. Collar size and thickness are supplied to suit the length of the cylinder, the thickness of the door and the trim ordered. (If door thickness is not specified, collars will be furnished for 1-3/4" (44mm) door.)

Collar length required must be specified for cylinders and/or housings ordered separately.

1765 Recessed Cylinder Collar

"A" Dimension: Thicknesses from 1/16" (2mm) to 1-15/32" (37mm) as required.

Material: Brass, Stainless Steel

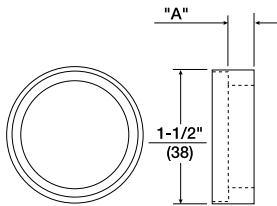



Dimensions and Compatible Exit Devices

Exit Trim

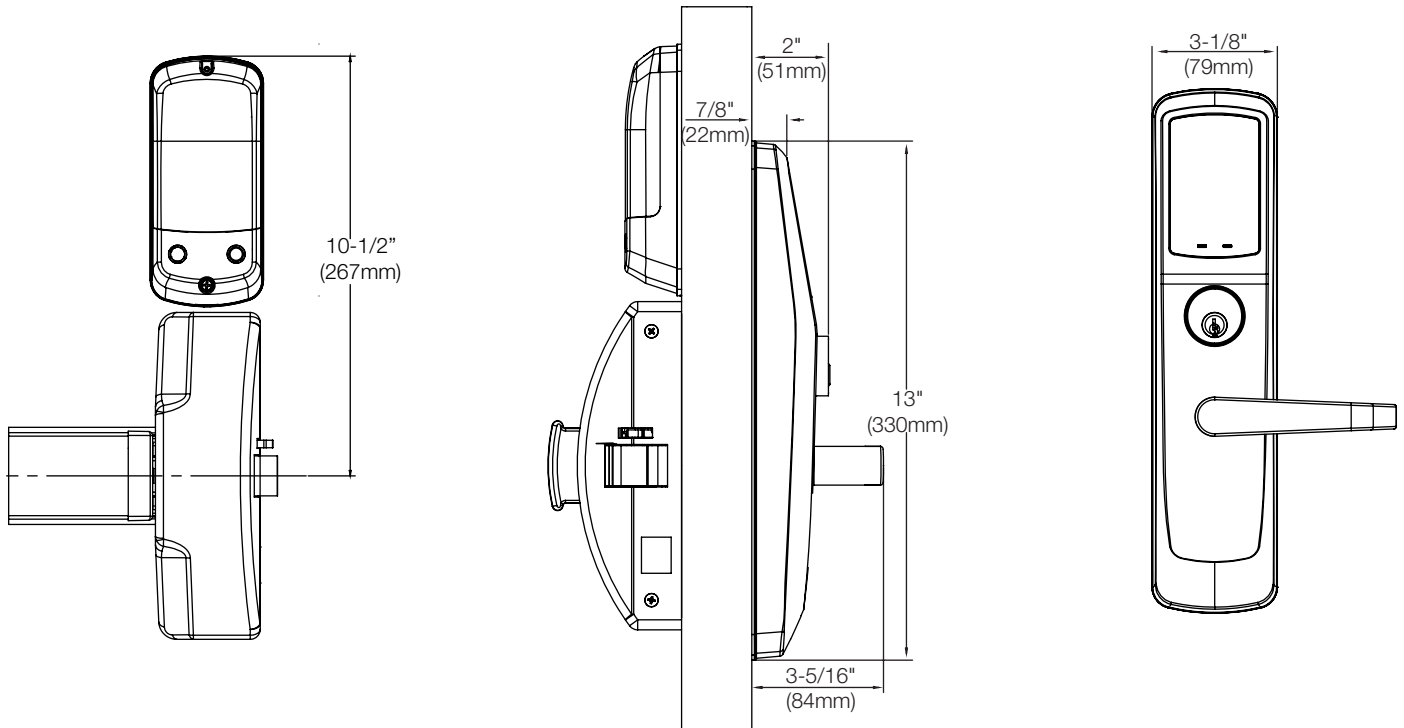

Dimensions given in inches (mm).

Compatible Exit Devices

Thanks to its patented adjustable mounting posts, Yale nexTouch exit trim is compatible with several makes and models of exit devices right out of the box, without the need for separate mounting hardware. Check the chart below to see if yours is a fit.

Manufacturer	Model/Series Number*
Arrow	3880
Corbin Russwin	ED5200, ED5200S
Dorma	9300
Falcon®	24
SARGENT	8800
Von Duprin®	98, 99
Yale	1800, 2100, 6000, 7000

*Compatible with rim device only. Please contact Technical Product Support for more information.

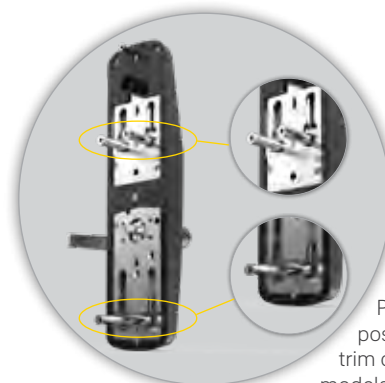

Patented adjustable mounting posts make the nexTouch exit trim compatible with many exit device models (see chart at left).

Compatible Exit Devices



7000 Series Architectural Exit Device

The Yale 7000 Series delivers an unparalleled combination of durability, innovation and aesthetics.



Features

- Premium exit device with high quality steel chassis and heavy-duty components
- Sleek design with a variety of finish options
- ANSI/BHMA Grade 1 Certified
- UL/cUL listed for panic and fire doors
- Windstorm certified
- Five year mechanical warranty

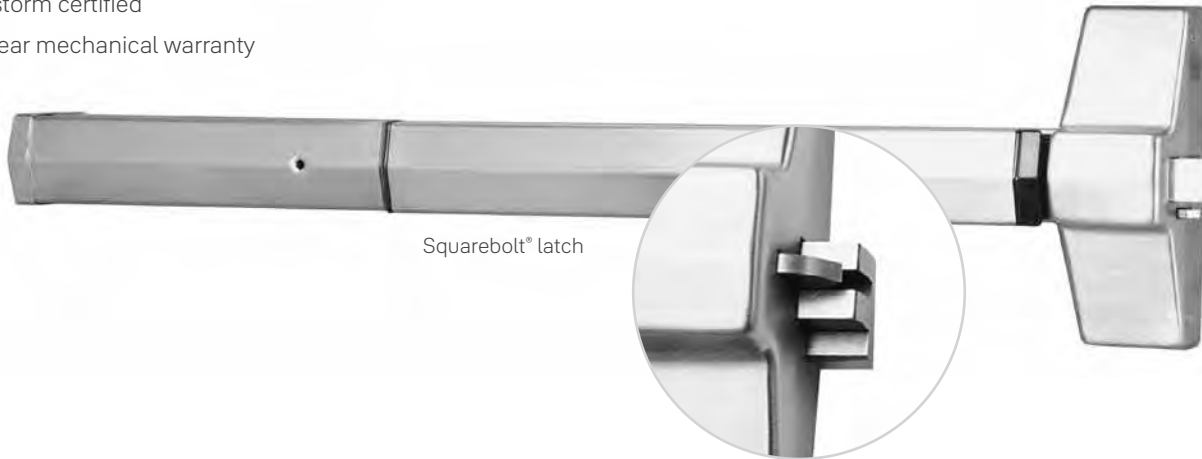

Squarebolt® latch

Finishes

ANSI/BHMA Code Finish Description			
605 Bright Brass, Clear Coated	613E Dark Oxidized Satin Bronze - equivalent	630 Satin Stainless Steel	BSP Black Suede Powder Coat
			

How To Order

Model #	Size	Finish	Handing
7100F – Rim, fire-rated	36 – Door widths from 36" to 42"	605 – Bright brass	RHR
7150FWS – Squarebolt®, fire-rated	48 – Door widths from 42" to 48"	613E – Dark satin bronze equivalent	LHR
		630 – Satin stainless steel	
		BSP – Black suede powder coat	

Compatible Exit Devices



6000 Series Commercial Exit Device

The Yale 6000 Series offers clean, modern lines and smooth, quiet operation in any application.



Features

- Attractive modern design available in a range of finishes
- Uniquely engineered for smooth operation and noise reduction
- ANSI/BHMA Grade 1 Certified
- UL/cUL listed for panic and fire doors
- Ten year mechanical warranty



Finishes

ANSI/BHMA Code Finish Description			
605 Bright Brass, Clear Coated	613E Dark Oxidized Satin Bronze - equivalent	630 Satin Stainless Steel	BSP Black Suede Powder Coat

How To Order

Model #	Size	Finish	Handing
6100F – Rim device, fire-rated	36 – Door widths from 36" to 42"	605 – Bright brass	RHR
6150F – Squarebolt®, fire-rated	48 – Door widths from 42" to 48"	613E – Dark satin bronze equivalent	LHR
		630 – Satin stainless steel	
		BSP – Black suede powder coat	

Compatible Exit Devices



2100 Series Economy Exit Device

2100 Series Exit Devices from Yale feature sturdy construction for reliable function in economy applications.



Features

- Strong and reliable design meets the rigors of demanding environments
- High grade steel components
- ANSI/BHMA Grade 1 Certified
- UL/cUL listed for panic and fire rated doors
- Three year mechanical warranty



Finishes

ANSI/BHMA Code Finish Description		
613E Dark Oxidized Satin Bronze - equivalent	630 Satin Stainless Steel	BSP Black Suede Powder Coat
		

How To Order

Model #	Size	Finish	Handing
2100F – Rim device, fire-rated	36 – Door widths from 36" to 42"	613E – Dark satin bronze equivalent	RHR
	48 – Door widths from 42" to 48"	630 – Satin stainless steel	LHR
		BSP – Black suede powder coat	



Exit Trim

Model/Part Number	Description
784	Optional remote 9VDC power supply with plug-in wall transformer (used for hardwiring up to two nexTouch locks).
WH-28	Remote unlock and power wire harness (used for hardwiring).
NTX600-ACC-KEY	Yale Accentra™ module*

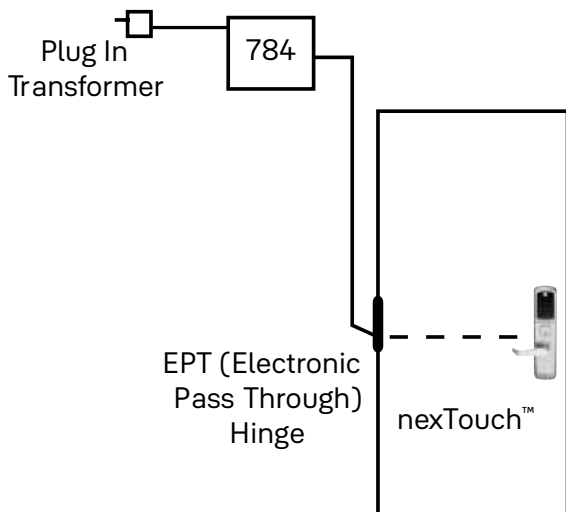

*This technology module can be used to upgrade stand-alone nexTouch locks for use in the Yale multi-family solution by enabling data-on-card technology. This is included when ordering nexTouch locks with ACC in the order string.





Exit Trim

ADA



The nexTouch Series lever design meets accessibility guidelines of the Americans with Disabilities Act and the requirements of the Uniform Federal Accessibility Standards and ICC/ANSI A117.1 Accessible and Usable Buildings and Facilities, all requiring ease of accessibility.

FCC

Complies with limits for a Class A digital device, pursuant to part 15 of the FCC Rules.

ISO 14001

Designed and manufactured under a certified ISO 14001 quality system.

ANSI/BHMA

nexTouch exit trim certified ANSI/BHMA A156.3, Grade 1.

Warranty

nexTouch has a three year limited warranty on the mechanical and electrical components, and a one year limited warranty on the finish.

Fire Listings



Functions are UL/cUL Fire Listed for use on fire doors having a rating up to and including 3 hours.

Note: Any retrofit or other field modification to a fire rated opening can potentially impact the fire rating of the opening, and Yale Locks & Hardware makes no representations or warranties concerning what such impact may be in any specific situation. When retrofitting any portion of an existing fire rated opening, or specifying and installing a new fire-rated opening, please consult with a code specialist or local code official (Authority Having Jurisdiction) to ensure compliance with all applicable codes and ratings.

Control Access to Residence Doors



Yale Assure™ Interconnected Lock



Shown with Valdosta lever

Technical Specifications

Door Specifications	2-1/8" Face Bore, 1" Edge Bore, 4" or 5-1/2" Center to Center
Backset	2-3/8" (60mm) or 2-3/4" (70mm)
Door Thickness	1-3/8" (35mm) to 1-3/4" (44mm)
Handing	Field reversible
Latch Faceplate	1" (25mm) W x 2-1/4" (57mm) H; round corner standard, square corner available to order
Strike	2-1/4" (57 mm) full lip; round corner standard, other strikes available to order
Cylinder	KW-1 compatible standard, other cylinders/keyways available to order
Keying	KD (Keyed Different) standard, master keying available to order
Packing	Box pack
ANSI/BHMA	Certified ANSI/BHMA A156.12, Grade 2
UL/cUL	Listed for 90 minute fire doors
Warranty	1-year electrical and finish warranty; 3-year mechanical warranty
Environmental Specifications	Outside temperature range: -22°F to +140°F (-30°C to +60°C) Inside temperature range: 5°F to +158°F (-15°C to +70°C) Battery temperature range: -14°F to +131°F (-10°C to +55°C) Storage temperature range: -40°F to +85°F (-40°C to +85°C)
Power Source	4 AA alkaline batteries, included
Credentials	Seos™ cards and fobs



Capacitive Touchscreen

Rubber seal protects your door and shields your lock from weather elements.

Solid Metal Escutcheon - Provides quality and durability

Voice Assisted Programming

Touchscreen shown when activated

Low Battery Indicator

Lockout Indicator

Privacy Button - Prevents unwanted access from the outside at the touch of a button

Motorized tapered deadbolt with anti-cut hardened steel pin

Latchbolt and deadbolt are retracted simultaneously in a single motion for quick and easy egress

How To Order



Use this outline to build the model number for the Yale Real Living™ Interconnected Lock you require.

Function	Technology	Lever	Center to Center	Cylinder	Latch	Finish**	Handing
YRC620 – Touchscreen interconnected lock	ACC – Data-on-Card	AC – Academy	4 - 4" 5 - 5-1/2"	KA – KW keyed alike	RC – Radius Corner SC – Square Corner	605 – Bright Brass, Clear Coated (US3)	RH LH
		AU – Augusta		KD – KW keyed different		619 – Satin Nickel Plated, Clear Coated (US15)	
		DE – Delaware		PA – PARA keyed alike		OBE – Dark Oxidized Satin Bronze - Equivalent (613E/US10BE)	
		MA – Marina		PD – PARA keyed different		OBP – Oil Rubbed Bronze - Permanent (US10BP)	
		MC – McClure		SA – SC keyed alike		BSP – Black Suede Powder Coat	
		MN – Milan		SD – SC keyed different			
		MO – Monroe		SF – SFIC*			
		NW – Norwood					
		PB – Pacific Beach					
		VG – Virgo					
		VL – Valdosta					
		WL – Woodland					

*SFIC less cylinder

**Split finish can be ordered by specifying outside finish/inside finish, e.g. 619/OBP would result in all exterior hardware in 619 and all interior and strike hardware in OBP

Build Your Order String

Quantity	Function	Technology	Lever Design	Center to Center	Cylinder	Latch	Finish	Handing
Example:	YRC620	ACC	NW	4	KD	RC	619	RH

Notes:

- The Yale Real Living interconnected lock comes standard with three latches:
 - One adjustable backset deadbolt latch
 - One 2-3/8" backset lever latch
 - One 2-3/4" backset lever latch
- Non-standard latches must be ordered separately.
- Latches shipped as radius corner unless otherwise specified. See options for availability.
- All master key, builder key or keyed alike requests must be added to the order as a note.
- OBE (613E) locks ship with OBP finished installation hardware.
- BSP locks ship with OBP finished installation hardware and brass cylinder.





Yale Real Living Interconnected Lock

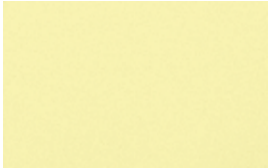
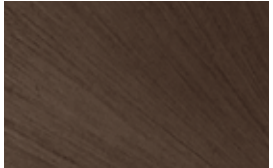

Lever Designs

ACADEMY AC	AUGUSTA AU	DELAWARE DW	MARINA MA
			
McCLURE MC	MILAN MN	MONROE MO	NORWOOD NW
			
PACIFIC BEACH PB	WOODLAND WL	VALDOSTA VL	VIRGO VG
			

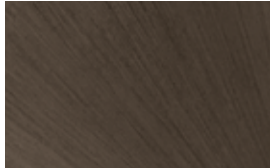
Finishes

ANSI/BHMA Code Finish Description				
605 (US3) Bright Brass, Clear Coated	613E (US10BE) Dark Oxidized Satin Bronze - equivalent. Specify OBE.	619 (US15) Satin Nickel Plated, Clear Coated	OBP (US10BP) Oil Rubbed Bronze - Permanent	BSP – Black Suede Powder Coat
				

- OBE (613E) locks ship with OBP finished installation hardware.
- BSP locks ship with OBP finished installation hardware and brass cylinder.

Functions

YRC620

Passage with Touchscreen

- Uses Yale Real Living™ touchscreen.
- Single point lock.
- Latchbolt retracted by lever outside with presentation of valid credential, with valid PIN code, or by operating lever inside.
- Deadbolt activated electronic touchscreen interaction or by key outside; inside by T-turn.
- Interior lever retracts latch and deadbolt simultaneously.





Dimensions

Center to Center Dimensions

Electronic

All electronic locksets available as 4" or 5-1/2" center to center dimension. Must be ordered this way from the factory and are not field changeable

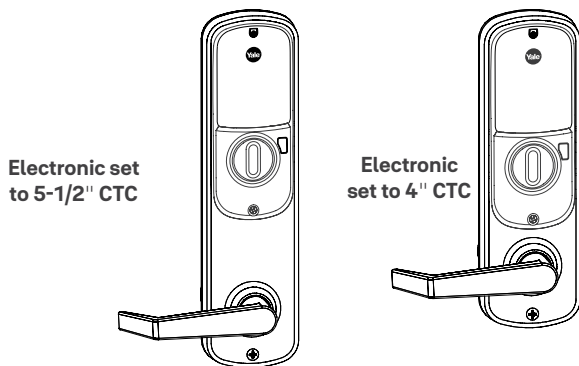

Product Dimensions

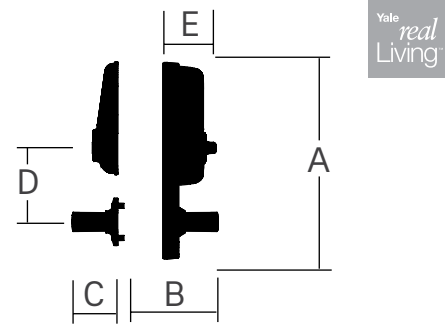

Dimensions				
A	B	C	D	E
10-5/8" 12-1/8"	2-5/8"	2-1/2"	4" 5-1/2"	2-13/16"

Cylinders

Fixed Core

Keyway	Description	Model Number	Number of Pins
Kwikset	Available KD, KA, MK	AYRD200-KW*	5
Yale® PARA	Available O-bitted, KD, KA, MK, BK	YRLPARA*	6
Schlage® C	Available O-bitted, KD, KA, MK	AYRD200-SC*	5

Note: Please indicate special keying requests such as builder keying (BK) or master keying (MK) on your order.

*Specify finish and keying.

BSP finished hardware ships with brass cylinder.

Interchangeable Core

All units ordered with SFIC will be provided less core. Cores can be ordered separately using model numbers A600 or K600.

Latchbolts



Lockset Latches

Plain latchbolts are supplied for the lockset of the interconnected lock.

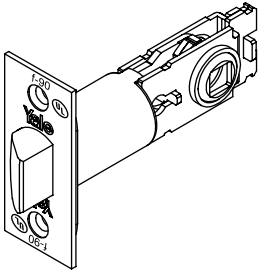

Plain					
Part No.	Front	Backset	Front Width	Throw	Latch Diameter*
YR01802*U	Round	2-3/8" (60mm)	1" (25mm)	1/2" (13mm)	7/8" (22mm)
YR01804*U	Square	2-3/8" (60mm)	1" (25mm)	1/2" (13mm)	7/8" (22mm)
YR01806*U	Round	2-3/4" (70mm)	1" (25mm)	1/2" (13mm)	7/8" (22mm)
YR01808*U	Square	2-3/4" (70mm)	1" (25mm)	1/2" (13mm)	7/8" (22mm)

*Specify finish when ordering:

"3" - 605

"6" - 619

"C" - 613E

"B" - 10BP

Note: All latchbolts are only available with flat fronts, not recommended for beveled doors. 1-1/8" latch filler provided.

Deadbolt Latches

Adjustable backset deadbolt latches are supplied standard for the deadbolt of the interconnected lock.

Model No.	Description	Front	Backset	"W" Front Width	Throw
AYRDB-R90 *	Adjustable deadbolt latch	Round	Adjustable^	1" (25mm)	1" (25mm)
AYRDB-SQ90*	Adjustable deadbolt latch	Square	Adjustable	1" (25mm)	1" (25mm)

* Specify finish (605, 619, 0BP)

^Adjustable between 2-3/8" and 2-3/4"

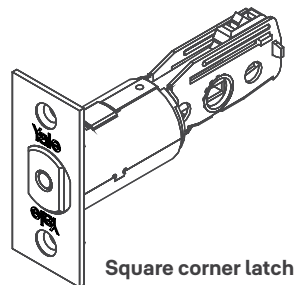
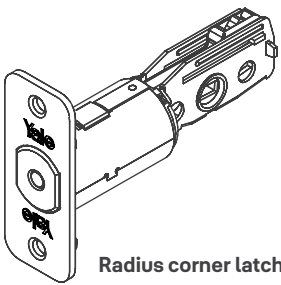

Strikes



Yale® interconnected locks are available with a variety of strike options. All strikes are located on the same vertical and horizontal center lines as the latchbolt and deadbolt. All strikes are reversible. Strikes are fabricated of either brass, bronze or stainless steel, depending on the lockset trim finish. When ordering strikes separately, please specify the finish required.

Lockset

Model No. YR02000* Full Lip Strike Radius Corner
Standard. Plastic strike dust box available separately.

Model No. YR02001* Full Lip Strike Square Corner
Optional. Plastic strike dust box available separately.

Model No. YR02020* T-Strike
Optional. Plastic strike dust box available separately.

Model No. YR02030* ANSI 4-7/8 Strike
Optional. Plastic strike dust box available separately.

Model No. YR026003 Plastic Strike Dust Box
Available separately.

Deadbolt

Model No. AYRD-SCREW* Deadbolt Strike Radius Corner with Screw Pack
Standard.

Model No. YR02086* Universal Deadbolt Strike Square Corner
Optional strike available for all mechanical units. Plastic strike dust box available separately.

* Specify finish when ordering strikes separately:

"3" - 605

"6" - 619

"C" - 613E

"B" - 10BP

Note: See Yale Residential price catalog for additional optional deadbolt strikes.



Control Access to Residence Doors



Yale Assure™ Digital Deadbolt



Technical Specifications

Door Specifications	2-1/8" face bore, 1" edge bore
Backset	2-3/8" or 2-3/4" backset
Door Thickness	1-3/8"* to 2-1/4" * Thin door kit required for 1-3/8" thick doors
Handing	Auto handing after installation
Latch	2-3/8" to 2-3/4" adjustable
Latch Faceplate	1" x 2-1/4" RC (round corner)
Strike	1-1/8" x 2-3/4" RC (round corner)
Cylinder	KW-1 compatible standard, other cylinders/keyways available to order
Keying	KD (Keyed Different) standard, master keying available to order
Packing	Box pack
ANSI/BHMA	Certified ANSI/BHMA A156.36, Grade 2
UL/cUL	Functions are UL - cUL Fire Listed for use on fire doors having a rating up to and including 90 minutes
Warranty	1-year electrical and finish warranty; 3-year mechanical warranty
Environmental Specifications	Outside temperature range: -22°F to +140°F (-30°C to +60°C) Inside temperature range: 5°F to +158°F (-15°C to +70°C) Battery temperature range: -14°F to +131°F (-10°C to +55°C) Storage temperature range: -40°F to +85°F (-40°C to +85°C)
Power Source	4 AA alkaline batteries, included
Credentials	Seos cards and fobs

Capacitive
Touchscreen

Solid Metal Escutcheon -
Provides quality and durability

Rubber seal protects your door and
shields your lock from weather elements.

Voice Assisted Programming

Touchscreen shown
when activated

Low Battery
Indicator

Lockout Indicator

Motorized tapered
deadbolt with anti-cut
hardened steel pin

Privacy Button -
Prevents unwanted
access from the outside
at the touch of a button

Note - Mechanical locks, including
levers, are sold separately.



How to Order & Finishes

How To Order

Use this outline to build the model number for the Yale Real Living™ Digital Deadbolt you require.





Function	Technology	Cylinder ¹	Finish
YRD620 – Touchscreen deadbolt	ACC – Data-on-Card	KA – KW keyed alike KD – KW keyed different PA – PARA keyed alike PD – PARA keyed different SA – SC keyed alike SD – SC keyed different	605 – Bright Brass, Clear Coated (US3) 619 – Satin Nickel Plated, Clear Coated (US15) OBE – Dark Oxidized Satin Bronze - Equivalent (613E/US10BE) ² OBP – Oil Rubbed Bronze - Permanent (US10BP) BSP – Black Suede Powder Coat

1. SFIC cylinder housing can be ordered using part number AYRD220-1. Please specify finish. SFIC housing ships separately as an accessory and is supplied less cylinder.

Build Your Order String

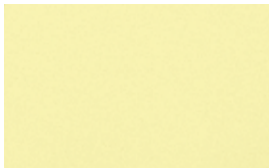
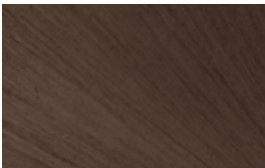
Quantity	Function	Technology	Cylinder	Finish
Example:	YRD620	ACC	KD	619

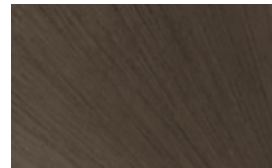
Finishes

ANSI/BHMA Code Finish Description				
605 (US3) Bright Brass, Clear Coated	613E (US10BE) Dark Oxidized Satin Bronze - equivalent. Specify OBE.	619 (US15) Satin Nickel Plated, Clear Coated	OBP (US10BP) Oil Rubbed Bronze - Permanent	BSP – Black Suede Powder Coat
				

Notes:

- The Yale Real Living digital deadbolt comes standard with a round corner adjustable deadbolt latch. Non-standard latches must be ordered separately.
- Doors less than 1-3/4" thick require a thin door kit. See page 64.
- All master key, builder key or keyed alike requests must be added to the order as a note.
- OBE (613E) locks ship with OBP finished installation hardware.
- BSP locks ship with OBP finished installation hardware and brass cylinder.



Fixed Core

Cylinder	Description	Model Number	Number of Pins
Kwikset	Available KD, KA, MK	AYRD200-KW*	5
Yale® PARA	Available 0-bitted, KD, KA, MK, BK	YRLPARA*	6
Schlage® C	Available 0-bitted, KD, KA, MK	AYRD200-SC*	5

Note: Please indicate special keying requests such as builder keying (BK) or master keying (MK) on your order.

*Specify finish.

BSP finished hardware ships with brass cylinder.

Thin Door Kit

Part Number: AYRDT226-TS-GSK

Thin door kit required for doors under 1-3/4" in thickness.

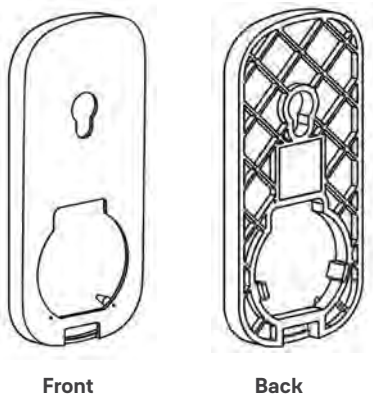

Strikes



Deadbolt

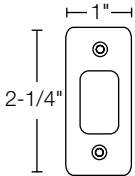

Model No. AYRD-SCREW* Deadbolt Strike Radius Corner with Screw Pack
Standard strike.

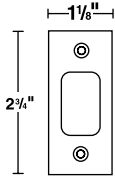

Model No. YR02086* Universal Deadbolt Strike Square Corner
Optional strike available for all electromechanical units. Plastic strike dust box available separately.

Specify finish when ordering strikes separately:

- "3" - 605
- "6" - 619
- "B" - 10BP
- OBE (613E) locks ship with OBP finished installation hardware.
- BSP locks ship with OBP finished installation hardware and brass cylinder.

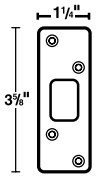

YR02081*

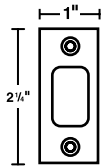

YR02082*

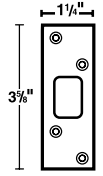

YR02083*

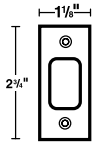

YR02086*

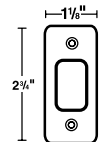

YR02088*

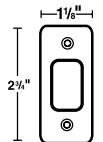

YR02089*

Latchbolts



Deadbolt Latches

Adjustable backset radius corner deadbolt latch is supplied standard. Square corner latch and strike plate must be ordered separately.

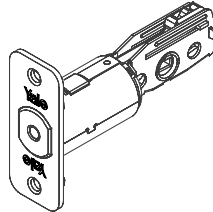

Model No.	Description	Front	Backset	"W" Front Width	Throw
AYRD-RC90*	Adjustable deadbolt latch	Round	Adjustable^	1" (25mm)	1" (25mm)
AYRD-SQ90*	Adjustable deadbolt latch	Square	Adjustable	1" (25mm)	1" (25mm)

* Specify finish (605, 619, 0BP). BSP finished hardware ships with 0BP strikes and latch.

^Deadbolt latches are adjustable between 2-3/8" and 2-3/4". Drive-in not pictured.

Suiting Your Hardware



Yale Commercial and Yale Residential Hardware come in unique finishes that suite through your facility no matter which door you're outfitting. See the matrix below to reference the most exact matches.

nexTouch Products (Cylindrical, Mortise, Exit Trim)		Assure Products (Deadbolt and Interconnected)		Exit Devices	
605	Bright Brass, Clear Coated	US3	Bright Brass, Clear Coated	605	Bright Brass, Clear Coated
613E	Dark Oxidized Satin Bronze Equivalent	US10BE	Dark Oxidized Satin Bronze Equivalent	613E	Dark Oxidized Satin Bronze Equivalent
		OBP	Oil Rubbed Bronze		
626	Satin Chrome Plated	US15	Satin Nickel Plated, Clear Coated	630	Satin Stainless Steel
BSP	Black Suede Powder Coat	BSP	Black Suede Powder Coat	BSP	Black Suede Powder Coat



Trusted every day

Technical Support

(troubleshooting, product use and application, returns)
Tel: 800.810.WIRE (9473)
Email: 800810WIRE@assaabloyusa.com

Customer Support

(orders, product configuration, pricing, lead-time)
Tel: 866-889-6242, select Option 2
Fax: 203-603-5981
Email: ESS.Orders@assaabloy.com

Contact Us

U.S.A.

Yale Locks & Hardware

Address: 225 Episcopal Road
Berlin, CT 06037-4004
Tel: 1-800-438-1951
Fax: 1-800-338-0965
us.yalehome.com
yalecommercial.com

Canada:

ASSA ABLOY Door Security Solutions Canada

Address: 160 Four Valley Drive
Vaughan, Ontario L4K 4T9
Tel: 1-800-461-3007
Fax: 1-800-461-8989
assaabloydss.ca

International:

ASSA ABLOY Americas International

Tel: 1-905-821-7775
Fax: 1-905-821-1429
assaabloyai.com

THE YALE BRAND, with its unparalleled global reach and range of products, reassures more people in more countries than any other consumer locking solution.

THE ASSA ABLOY GROUP is the world's leading manufacturer and supplier of locking solutions, dedicated to satisfying end-user needs for security, safety and convenience.

Yale Commercial is a business associated with ASSA ABLOY Access and Egress Hardware Group, Inc., an ASSA ABLOY Group company. Copyright © 2016-2020, ASSA ABLOY Access and Egress Hardware Group, Inc. All rights reserved. Reproduction in whole or in part without the express written permission of ASSA ABLOY Access and Egress Hardware Group, Inc. is prohibited. Patent pending and/or patent www.assaabloydss.com/patents.



Condensed Catalog

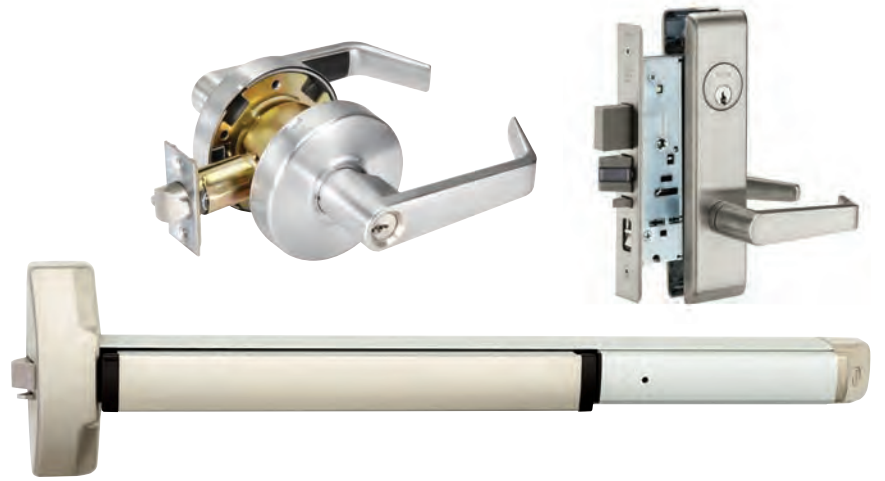

Introduction



Yale Locks & Hardware, an ASSA ABLOY Group company based in Berlin, CT, has provided dependable security since 1840. A leading manufacturer in the industry, Yale offers a broad line of door hardware developed for commercial, retail, office buildings, and mixed-use facilities as well as a wide variety of residential options. Our products include mortise and cylindrical locks, exit devices, decorative hardware, door closers, electromechanical products and key systems, as well as solutions for windstorm, multi-family and small business.

When you need an affordable, reliable solution for your facility, Yale Works for YouSM.

For further information, contact your Door Security Solutions sales representative, call 800-438-1951 or visit us at www.yalecommercial.com.

Contents

Introduction.....	2
Reflections® Decorative Levers.....	3
Mortise Locksets	4
Mortise Lock Trim.....	5-6
Mortise Lock Status Indicators	7
Cylindrical Locksets	8-13
RL Series Tubular Locks	14
Monolocks.....	15
Auxiliary Locks.....	16
Lockset Functions.....	17-22
Exit Devices.....	23-25
Exit Device Functions	26
Exit Device Trim	27-28
Cylinders and Keying/Security Cylinders	29
Door Controls.....	30-33
Electrified Products.....	34-36
NexTouch® Keypad Locks	37-39

Americans With Disabilities Act (ADA)

Title III of the Americans With Disabilities Act (ADA), Public Law 101-336, went into effect on January 28, 1992. The ADA "prohibits discrimination on the basis of disability by private entities in places of public accommodation and that the commercial facilities be designed and constructed so as to be readily accessible to and usable by persons with disabilities..." (Federal Register, Vol. 56, No. 144/7-26-91/Rules and Regulations).

Yale locksets and door controls that comply with ADA requirements are indicated as such by the accessibility symbol in this catalog.

MicroShield®

Yale locks and exit devices are available with MicroShield antimicrobial coating. MicroShield is a revolutionary hardware finish coating, using a silver ion based technology, which inhibits the growth of bacteria, algae, yeast, fungus, mold and mildew. MicroShield is non-toxic and lasts for the lifetime of the finish to which it is applied. To order, suffix option code "YMS".

Note: MicroShield coating may vary finish color from architectural standards. Locksets and exit devices available with MicroShield will be indicated as such by the MicroShield icon. MicroShield is not intended as a substitute for traditional infection control programs such as hand hygiene or use of disinfectants. Coated products must still be cleaned to ensure the surfaces will be free of destructive microbes. Yale makes no representations or warranties, express or implied, as to the efficacy of MicroShield.



**8800 Series
Mortise Locksets**
See page 4



**4600LN Series
Lever Locksets**
See page 12



**D Series
Cylindrical Deadbolts**
See page 16



**6000 Series
Exit Devices**
See page 24



nexTouch®
See page 37

Reflections® Decorative Trim



For more than 150 years, Yale has distinguished itself as an innovative manufacturer and designer of locksets and door hardware. That tradition continues with Reflections® by Yale®, a comprehensive line of highly stylized door levers and coordinating hardware. This premier product series is available for Yale® 8800RL mortise locks, RL tubular locks and exit device trim, creating a continuity of beautiful design throughout a building.

Reflections consists of 36 dynamic and distinctive levers. Each captures a unique beauty and spirit of design unlike any other. These exquisite levers offer Yale quality and exceptional elegance to a variety of high-end commercial projects, including office buildings, museums, upscale hotels and resorts, and large multi-use projects such as apartment and condominium complexes.

Let Reflections® by Yale® inspire your vision of great design.



Hudson	Spree	Seine	Thames	Victoria	Niagara
TB	RS	TG*	TM	TT*	CH*
UB	RT	TO*	TN	TU*	DW
TC	RU	TJ*	TP	TV*	MA*
TD	RV	TK*	TR	TW*	RA*
UC		TE	TS	UW*	RB*
		TI	TQ	TX*	RC*
				UX*	
				TY*	
				TZ*	

*Indicates levers that are handed.

Note: The following Reflections levers are not available in 629 or 630 finish: Victoria TT, TU, TV, TW, TX, TY, UW, UX, TZ; Seine TG, TJ, TK, TO; Danube TE, TI; Hudson TD. Please consider the 618 or 619 finish as an alternative. Reflections levers are not available with knurling option.

Mortise Locksets



8800 Series Mortise Locksets

Yale 8800 Series Mortise Locks are designed and manufactured for uncompromising strength and durability in a range of commercial applications. Lock installation is made easy with quick lever handing, field reversible latchbolt and standard nonhanded strike. The 8800 Series Mortise Lock offers a new measure of security, featuring a reinforced stainless steel deadbolt, heavy-duty, vandal-resistant trim and ANSI/BHMA Grade 1 certification for long life and durability. The 8800 Series Mortise Lock is even backed by a 10 year mechanical warranty, making this product completely worry-free. See pages 34-36 for information on electrified options.



Features

ANSI/BHMA: A156.13, Series 1000 Grade 1 

UL/cUL: UL/cUL fire-rated up to 3 hours

Windstorm: Certified (refer to local codes)  Hurricane

Lock Case and Cover: Heavy-gauge wrought steel, zinc-plated, dichromated

Backset: 2-3/4" only

Deadbolt: Stainless steel, 1" throw

Latchbolt: 3/4" throw, stainless steel one-piece anti-friction

Guardbolt: Non-handed. Deadlocks latchbolt when door is closed

Armor Front: 8" x 1-1/4"

Rabbeted Doors: Non-handed for 1/2" rabbet

Lead Shielding: Available to order

Cylinders: Brass, 6-pin, keyed-random cylinder with two keys furnished standard, 7-pin available to order. For other cylinder and keying options see page 29.

Reversibility: Locksets are handed and offer quick field reversibility

Strikes: 1-1/4" Non-handed curved lip standard; other curved lip and flat available to order

Finishes: Available in 17 standard finishes

Warranty: 10-year mechanical

Heavy-Duty Escutcheon Trim

8800 Series locks with escutcheon trim are provided standard with the Camden (CN) escutcheon. This zinc die cast escutcheon features one-piece casting for superior strength.

Locks with this escutcheon are ANSI/BHMA certified operational and security Grade 1 and will retrofit to existing Yale escutcheon preps. The aesthetics of the CN escutcheon provide a design continuum with Yale exit device trim for a consistent look throughout the facility.

















Mortise Lock Trim



8800FL Series Standard Lever Trim



All thrubolted.



Arcadia*		Augusta	
			
ARR	AR x CN	AUR	AU x CN
Carmel		Jefferson	
			
CRR	CR x CN	JNR	JN x CN
Monroe		Pacific Beach	
			
MOR	MO x CN	PBR	PB x CN
Pinehurst		Virginia	
			
PNR	PN x CN	VIR	VI x CN



* Indicates levers that are handed.

8800 Series Standard Knob Trim All Thrubolted

Copenhagen	
	
COR	CO x CN

8800FL Designer Trim All Thrubolted



Hampton	
	
HAR5	HAE3

Optional Designer Rose And Escutcheon

R2	E2
	
HAR3	HAE4

Mortise Lock Trim



Reflections® Decorative Levers

Yale® 8800RL Mortise Locks are available with Reflections lever trim, a comprehensive line of highly stylized lever handles. Reflections lever handles are made from solid brass or stainless steel and can withstand years of abuse. Available in a multitude of finishes, the levers complement any wood grain or other door exterior. Each lever is hand-polished and specially designed for ergonomics and style.

Features

- All 8800RL Series lever trims feature thrubolted installation. For sectional trims, this ensures positive alignment of the trim with the lock case.
- All outside trim is held in place by threaded posts. For sectional trims, the posts fit through holes in the lock case and are secured by thrubolts from the inside trim. For escutcheon trims, the posts fit through the door and are secured by thrubolts from the inside trim.
- Outside escutcheon trims have no visible screws - a great deterrent to vandalism.
- 8800RL Mortise Locks feature an internal heavy-duty spring cartridge which prevents lever sag.
- All 8800RL trims are UL/cUL listed for fire door applications.
- Available for 1-3/4" to 3-1/4" thick doors.
- Lever designs are available as shown on page 3.

Reflections® Roses

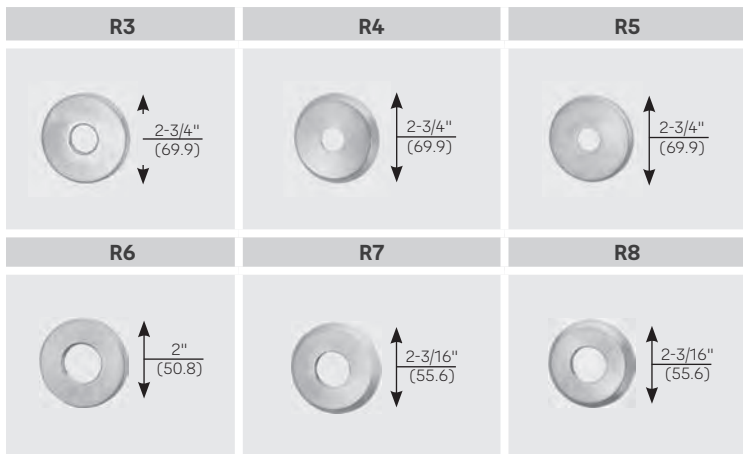

Reflections® Escutcheons





Mortise Lock Status Indicators

Applications

8800 Series indicators can be used in a variety of applications and are most commonly used to identify occupancy or display the locked/unlocked status of a room.

- Restrooms
- Quiet rooms
- Nursing mother's rooms
- Classroom doors



Features

- Inside, outside or both sides of the door
- Sectional or escutcheon trim
- Available with 24 different functions – including thumbturn functions
- Viewing window 25% larger than competition
- Patented curved design for viewing at multiple angles
- Window located prominently above the cylinder
- Highly reflective viewing window for increased safety
- Optional directional engraving available – must specify handing
- Retrofittable for existing applications

Functions

- Indicators are available with the following 8800 Series functions. See pages 17-22 for details.

8802	8827
8808	8832
8808-2	8840
8809	8847
8811-2	8860
8812-2	8860-2
8814	8861
8814-2	8862
8815	8864
8818-2	8865
8820	8866
8822	8867

Cylindrical Locksets





5400LN Series Cylindrical Lever Locksets

Designed for commercial and industrial use, the Yale 5400LN offers no compromise when it comes to reliability and performance. With construction features such as our Free Wheeling lever mechanism, wear-resistant chassis plates, heavy-duty return springs and door thickness adjustment, it's easy to see why the 5400LN is a favorite among those who demand the highest standard of product quality. See pages 33-34 for information on electrified options.



Features

- ANSI/BHMA:** A156.2, Series 4000 Grade 1 
- UL/cUL:** UL/cUL fire-rated up to 3 hours
- Windstorm:** Certified (refer to local codes)  Hurricane
- Mechanism:** Heavy-gauge steel, zinc-plated, dichromated
- Backset:** 2-3/4" standard; 3-3/4" or 5" extension link available to order
- Latchbolt:** 1/2" stainless steel throw standard; 3/4" throw available to order
- Guardbolt:** Deadlocks latchbolt when door is closed; standard on all locking functions
- Door Thickness:** Adjustable from 1-3/4" to 2". Available to 2-1/4" doors to order.
- Fronts:** 2-1/4" x 1-1/8" beveled standard; flat fronts available to order
- Lead Shielding:** Available to order
- Cylinders:** Brass, 6-pin, keyed-random cylinder with two keys furnished standard, 7-pin available to order. For other cylinder and keying options, see page 29.
- Reversibility:** Non-handed
- Strikes:** 1-1/4" curved lip for 1-3/4" door standard; other lip lengths available to order; all reversible
- Finishes:** Available in 13 standard finishes
- Warranty:** 7-year mechanical

5400LN Series Trim



Levers available to accept small format interchangeable cores and large format interchangeable cores from ASSA®, Medeco® and Schlage®. Fixed core cylinders available with keyways from Corbin®, Corbin Russwin®, Russwin®, Sargent® and Schlage®.

Cylindrical Locksets



5400CK Series Cylindrical Knob Locksets

When demanding the highest standard of product performance in even the toughest industrial applications, look no further than the Yale 5400CK Series Heavy-Duty Grade 1 cylindrical locksets. These high-quality key-in-knob locksets offer the finest cylindrical lock mechanisms available and are constructed with high-grade materials for long-lasting reliability. Manufactured for the industrial, commercial and institutional markets, 5400CK Series locksets feature security, dependability and versatility in attractive designs and finishes that fulfill all decorative requirements and blend with any architectural décor.



Features

- ANSI/BHMA:** A156.2, Series 4000 Grade 1 
- UL/cUL:** UL/cUL fire-rated up to 3 hours
- Mechanism:** Heavy-gauge steel, zinc-plated, dichromated
- Backset:** 2-3/4" standard
- Latchbolt:** 1/2" stainless steel throw standard
- Guardbolt:** Deadlocks latchbolt when door is closed; standard on all locking functions
- Door Thickness:** Adjustable from 1-3/8" to 2" standard; Factory preset to 1-3/4" (44mm). 1-1/4" to 1-3/8" or 2" to 2-1/4" available to order for most trim
- Fronts:** 2-1/4" x 1-1/8" universal
- Cylinders:** Brass, 6-pin, keyed-random cylinder with two keys furnished standard. For other cylinder and keying options, see page 29.
- Reversibility:** Non-handed
- Strikes:** 1-1/4" curved lip ANSI 497 supplied standard, T-Strike optional. All strikes available with optional lip lengths and wrought boxes
- Finishes:** Available in 3 finishes
- Warranty:** 10-year mechanical

5400CK Series Trim

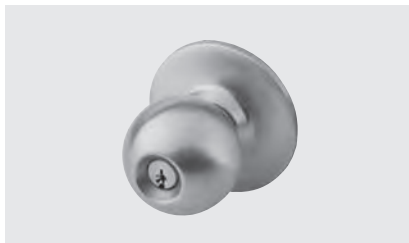

Carolina CA





5300LN Series Cylindrical Lever Locksets

This revolutionary lockset boasts features such as a vandal-resistant Free Wheeling lever mechanism and an adjustable door thickness design that makes installation a breeze. Thrubolting provides a secure fit that resists rattling and shaking. With three lever designs and eleven finishes, you have the freedom and ability to match any decor. See pages 34-36 for electrified information.



Features

- ANSI/BHMA:** A156.2, Series 4000 Grade 2 
- UL/cUL:** UL/cUL fire-rated up to 3 hours
- Windstorm:** Certified (refer to local codes)  Hurricane
- Mechanism:** Heavy-gauge steel, zinc-plated, dichromated
- Backset:** 2-3/4" standard; 2-3/8", 3-3/4" or 5" extension links available to order
- Latchbolt:** 1/2" stainless steel throw
- Guardbolt:** Deadlocks latchbolt when door is closed; standard on all locking functions
- Door Thickness:** Adjustable from 1-3/4" to 2". Available for 1-3/8" or 2-1/4" doors to order.
- Fronts:** Universal for both flat and beveled door edges
- Lead Shielding:** Not available
- Cylinders:** Brass, 6-pin, keyed-random cylinder with two keys furnished standard, 7-pin not available. For other cylinder and keying options see page 29.
- Reversibility:** Non-handed
- Strikes:** 1-1/4" curved lip for 1-3/4" door standard; other lip lengths available to order; all reversible
- Finishes:** Available in 13 standard finishes
- Warranty:** 5-year mechanical

5300LN Series Trim



Levers available to accept small format interchangeable cores and large format interchangeable cores from ASSA®, Medeco® and Schlage®. Fixed core cylinders available with keyways from Corbin®, Corbin Russwin®, Russwin®, Sargent® and Schlage®.

Cylindrical Locksets





4700LN Series Cylindrical Locksets

Yale® 4700LN cylindrical locks are the ideal choice for a wide variety of commercial applications where consistent quality, ease of use and installation are required at an economical price. The 4700LN series is certified to ANSI/BHMA Grade 1 standards and is UL fire-listed for all functions ensuring reliability and peace of mind. See pages 34-36 for electrified information.



Features

- ANSI/BHMA:** A156.2, Series 4000 Grade 1 
- UL/cUL:** UL/cUL fire-rated up to 3 hours
- Windstorm:** Certified (refer to local codes)  Hurricane
- Mechanism:** Heavy-gauge steel, die-cast, zinc-plated, chromated
- Backset:** 2-3/4" standard
- Latchbolt:** 1/2" stainless steel throw standard
- Guardbolt:** Deadlocks latchbolt when door is closed; standard on all locking functions
- Door Thickness:** Adjustable from 1-3/4" to 2", available for 1-3/8" or 2-1/4" doors to order.
- Fronts:** 2-1/4" x 1-1/8" beveled standard; flat fronts available to order
- Cylinders:** Brass, 6-pin, keyed-random cylinder with two keys furnished standard, 7-pin not available. For other cylinder and keying options see page 29.
- Reversibility:** Non-handed
- Strikes:** ANSI strike 4-7/8" x 1-1/4" x 1-1/4" lip to center supplied standard. Optional T-strike available to order for 4700LN.
- Finishes:** Available in 8 standard finishes
- Warranty:** 5-year mechanical

4700LN Series Trim



Augusta AU



Monroe MO



Pacific Beach PB



Levers and knob available to accept 6- and 7- pin small format interchangeable cores.
Fixed core cylinders available with keyways from Corbin®, Corbin Russwin®, Russwin®, Sargent® and Schlage®.

Cylindrical Locksets





4600(LN) Series Cylindrical Locksets

Yale® 4600(LN) cylindrical locks are the ideal choice for a wide variety of commercial applications where consistent quality, ease of use and installation are required at an economical price. The 4600(LN) series is certified to ANSI/BHMA Grade 2 standards and is UL fire-listed for all functions ensuring reliability and peace of mind. 4600LN cylindrical lever locks are supplied with optional thrubolts. Installation of thrubolts is at the discretion of the installer.



Features

- ANSI/BHMA:** A156.2, Series 4000 Grade 2 
- UL/cUL:** UL/cUL fire rated up to 3 hours
- Windstorm:** 4600LN Certified (refer to local codes)  Hurricane
- Mechanism:** Heavy-gauge steel, zinc plated, dichromated
- Backset:** 2-3/4" standard; 2-3/8" to order
- Latchbolt:** 1/2" stainless steel throw
- Guardbolt:** Deadlocks latchbolt when door is closed; standard on all locking functions
- Door Thickness:** Adjustable from 1-3/8" to 1-3/4"
- Fronts:** Universal for both flat and beveled door edges
- Cylinders:** Brass, 6-pin, keyed-random cylinder with two keys furnished standard, 7-pin not available. For other cylinder and keying options see page 29.
- Reversibility:** Non-handed
- Strikes:** 1-1/4" curved lip for 1-3/4" door standard; other lip lengths to special order; all reversible
- Finishes:** Available in 7 finishes
- Warranty:** 3-year mechanical

4600 Series Trim



4600LN Series Trim

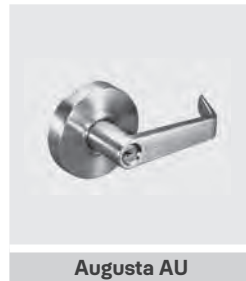

Levers and knob available to accept 6- and 7-pin small format interchangeable cores.
Fixed core cylinders available with keyways from Corbin®, Corbin Russwin®, Russwin®, Sargent® and Schlage®.

Cylindrical Locksets



4300LN Series Tubular Lever Locksets

An economical, light/medium-duty lever lockset that provides an outstanding combination of value and performance. It is the ideal lever lockset for light commercial and heavy-duty residential applications, including multi-family housing units, nursing homes, retail complexes, restaurants and hotels.



Features

- ANSI/BHMA:** A156.2, Series 4000 Grade 2 
- UL/cUL:** UL/cUL fire-rated up to 1-1/2 hours
- Mechanism:** Heavy-gauge steel, zinc-plated, dichromated
- Backset:** 2-3/4" standard; 2-3/8" available to order
- Latchbolt:** 1/2" stainless steel throw
- Guardbolt:** Deadlocks latchbolt when door is closed; standard on all functions
- Door Thickness:** Adjustable from 1-3/8" to 1-3/4"
- Fronts:** Square corner front standard; round corner available to order
- Cylinders:** Brass, 6-pin, keyed-random cylinder with two keys furnished standard, 7-pin not available. For other cylinder and keying options, see page 29.
- Reversibility:** Non-handed
- Strikes:** 1-1/4" curved lip T-strike standard; ANSI and full lip strikes available to order
- Finishes:** Available in 7 finishes
- Warranty:** 1-year mechanical

4300LN Series Trim



Augusta AU

Madrid MA

Monroe MO

Pacific Beach PB

RL Series Tubular Locksets



RL Series Tubular Locks are designed to work with Yale® Reflections® decorative levers. Engineered for ease of installation with the quality you expect from Yale, the RL series will meet and exceed the expectations of the most demanding architects and design professionals. Ideal interior applications include hospitality, mixed-use facilities, apartments and condominiums.



Features

- UL/cUL:** Available UL/cUL fire-rated up to 3 hours
- Backset:** 2-3/4" standard or 2-3/8" available to order
- Latchbolt:** 1/2" brass throw
- Door Thickness:** Adjustable from 1-3/8" to 1-3/4"
- Fronts:** 2-3/4" backset furnished standard with a 1-1/8" wide square corner front. 2-3/8" backset furnished standard with a 1" wide square corner front.
- Reversibility:** Non-handed
- Strikes:** 1-1/4" curved lip T-strike standard; ANSI and full lip strikes available to order
- Finishes:** Available in 15 finishes
- Warranty:** 1-year mechanical

RL Series Trim

See page 3 for Reflections® decorative levers.

Monolocks



6400LN Series Monolocks

Based on the Yale® 5400LN Grade 1 cylindrical lockset, the 6400LN Monolock continues the tradition of quality and dependability as a preassembled lock series designed to retrofit existing Yale® Monolock as well as Corbin Russwin Unit Lock and Falcon® Retrofit Lock installations with 1-3/4" latch height.



Features

- UL/cUL:** UL/cUL fire-rated up to 1-1/2 hours
- Mechanism:** Heavy-gauge steel, zinc-plated, dichromated
- Backset:** 2-3/4"
- Latchbolt:** 1/2" stainless steel throw
- Guardbolt:** Deadlocks latchbolt when door is closed; standard on all locking functions
- Door Thickness:** 1-3/4" only
- Lead Shielding:** Available to order
- Cylinders:** Brass, 6-pin, keyed-random cylinder with two keys furnished standard, 7-pin available to order. For other cylinder and keying options, see page 29.
- Reversibility:** Handing must be specified for all functions and designs
 - Strikes:** 1-1/4" lip ANSI strike supplied; other lip lengths and strikes available to order; all reversible
 - Finishes:** Available in 1 finish
 - Warranty:** 7-year mechanical

6400LN Series Trim



Levers available to accept small format interchangeable cores and large format interchangeable cores from ASSA®, Medeco® and Schlage®. Fixed core cylinders available with keyways from Corbin®, Corbin Russwin, Russwin®, Sargent® and Schlage®.



D100/D200 Series Cylindrical Deadbolts

- ANSI/BHMA:** D100 = A156.36, Grade 1
D200 = A156.36, Grade 2 
- UL/cUL:** UL/cUL fire-rated up to and including 3 hours. cUL fire-rated for wood doors up to 90 minutes.
- Backset:** 2-3/4" or 2-3/8" available to order
- Door Preparation:** Can be installed on metal doors prepared to ANSI/BHMA A156.115 Specifications
- Cross Bore Wood Doors:** Standard - 2-1/8" diameter
- Edge Bore:** 1" diameter
- Deadbolt:** 1" throw, solid steel deadbolt with hardened, free spinning, steel pin insert.
- Door Thickness:** 1-3/8" to 1-3/4" standard
- Cylinders:** Brass, 6-pin, keyed-random cylinder with two keys furnished standard. For other cylinder and keying options, see page 29.
- Reversibility:** Non-handed
- Strikes:** 2-3/4" x 1-1/8" metal and wood door strikes with strike reinforcement standard
- Finishes:** Available in 8 standard finishes
- Warranty:** 1-year mechanical



350 Series Auxiliary Mortise Deadlock

- UL/cUL:** UL/cUL fire-rated up to and including 3 hours. cUL fire-rated for wood doors up to 90 minutes.
- Case:** Heavy wrought steel, zinc-plated and dichromated
- Backset:** 2-3/4"
- Deadbolt:** Laminated stacked steel with hardened pin, 1" throw.
- Door Thickness:** 1-3/8" to 4" maximum, must be specified
- Front:** Universal for both flat and beveled door edges
- Thumbturn:** Brass, bronze or stainless steel. Thumbturn attaches directly to lock case for added security.
- Cylinder:** Brass, 6-pin, keyed-random cylinder with two keys furnished standard, 7-pin available to order. For other cylinder and keying options, see page 29.
- Reversibility:** Non-handed
- Finishes:** Available in 16 standard finishes
- Warranty:** 1-year mechanical



Lockset Functions



Function/ Application	(ANSI) Model Nos.	Mortise Locksets	(ANSI) Model Nos.	Cylindrical Knob Locksets	(ANSI) Model Nos.	Cylindrical Lever Locksets/ Monolocks
Passage or Closet Latch	(F01) Knob 8801 Levers 8801FL SL8801FL 8801RL		(F75) 5401CK 4601		(F75) 5401LN 5301LN 4701LN 4601LN 4301LN 6401LN	
Privacy, Bedroom or Bath Lock	(F19) Knob 8802 Levers 8802FL SL8802FL 8802RL		(F76A) 5402CK 4602		(F76A) 5402LN 5302LN 4702LN 4602LN 4302LN 6402LN	
Patio or Privacy Lock		N/A		N/A	(F77) 5403LN 5303LN 4703LN 6403LN	
Entry Lock		N/A		N/A	(F82A) 5404LN 5304LN 4704LN 4604LN 6404LN	
Storeroom or Closet Lock	(F07) Knob 8805 Levers 8805FL SL8805FL 8805RL		(F86) 5405CK 4605		(F86) 5405LN 5305LN 4705LN 4605LN 4305LN 6405LN	
Service Station Lock		N/A		N/A	(F92) 5406LN 5306LN 4706LN 6406LN	
Entry Lock	(F04) Knob 8807 Levers 8807FL SL8807FL 8807RL		(F109) 5407CK 4707 4607		(F109) 5407LN 5307LN 4707LN 4607LN 4307LN 6407LN	
Classroom Lock	(F05) Knob 8808 Levers 8808FL SL8808FL 8808RL		(F84) 5408CK 4708 4608		(F84) 5408LN 5308LN 4708LN 4608LN 4308LN 6408LN	
Note: Shaded area denotes rigid lever or knob.			Note: Shaded area denotes rigid knob.		Note: Shaded area denotes Free Wheeling lever (except 4300LN and 4600LN).	

Indicator options available for both sectional and escutcheon trim.

Lockset Functions



Function/ Application	(ANSI) Model Nos.	Mortise Locksets	(ANSI) Model Nos.	Cylindrical Knob Locksets	(ANSI) Model Nos.	Cylindrical Lever Locksets/ Monolocks
Intruder Latchbolt Lock	(F32) Knob 8808-2 Levers 8808-2FL SL8808-2FL 8808-2RL		N/A		N/A	
Classroom or Office Lock (Mortise) Exit Latch (Cylindrical)	Knob 8809 Levers 8809FL SL8809FL 8809RL		N/A		(F89) 5409LN 5309LN 4709LN 6409LN	
Intruder Deadbolt Lock	(F33) Knob 8811-2 Levers 8811-2FL SL8811-2FL 8811-2RL		N/A		N/A	
Intruder Deadbolt Lock	(F34) Knob 8812-2 Levers 8812-2FL SL8812-2FL 8812-2RL		N/A		N/A	
Classroom Deadlock	(F29) 8813ST		N/A		N/A	
Classroom Deadlock	8813ST-2		N/A		N/A	
Deadlock	(F18) 8814		N/A		N/A	
Deadlock	(F16) 8814-2		N/A		N/A	
	Note: Shaded area denotes rigid lever or knob.		Note: Shaded area denotes rigid knob.		Note: Shaded area denotes Free Wheeling lever.	

Indicator options available for both sectional and escutcheon trim.

Lockset Functions











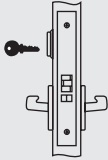

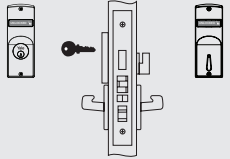
Function/ Application	(ANSI) Model Nos.	Mortise Locksets	(ANSI) Model Nos.	Cylindrical Knob Locksets	(ANSI) Model Nos.	Cylindrical Lever Locksets/ Monlocks
Deadlock	(F17) 8815			N/A		N/A
Apartment, Exit or Public Toilet Lock	(F09) Knob 8817-2 Levers 8817-2FL SL8817-2FL 8817-2RL			N/A	(F88) 5417LN 6417LN	
Classroom Security Intruder Lock	Knob 8818-2 Levers 8818-2FL SL8818-2FL 8818-2RL			N/A	(F110) 5418LN 5318LN 4718LN 6418LN	
Store Door Lock		N/A		N/A		N/A
Hotel Guest Lock	(F15) Knob 8820 Levers 8820FL SL8820FL 8820RL			N/A		N/A
Communicating Lock		N/A		N/A	(F80) 5421LN 5321LN 4721LN 6421LN	
Dormitory, Exit or Corridor Lock	(F13) Knob 8822 Levers 8822FL SL8822FL 8822RL			N/A	(F90) 5422LN 5322LN 4722LN 6422LN	
Storeroom Lock	Knob 8823 Levers 8823FL SL8823FL 8823RL			N/A		N/A
	Note: Shaded area denotes rigid lever or knob.		Note: Shaded area denotes rigid knob.		Note: Shaded area denotes Free Wheeling lever.	

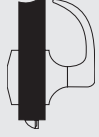
 Indicator options available for both sectional and escutcheon trim.

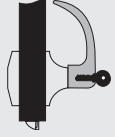
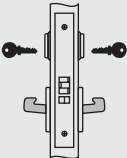
Lockset Functions

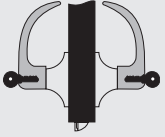
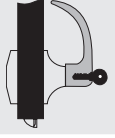

Function/ Application	(ANSI) Model Nos.	Mortise Locksets	(ANSI) Model Nos.	Cylindrical Knob Locksets	(ANSI) Model Nos.	Cylindrical Lever Locksets/ Monolocks
Holdback Lock	Knob 8824 Levers 8824FL SL8824FL 8824RL			N/A		N/A
Privacy Lock		N/A		N/A	5425LN 5325LN 4725LN 6425LN	
Hotel/Motel Lock	Knob 8827 Levers 8827FL SL8827FL 8827RL			N/A		N/A
Exit or Communicating Passage Lock	(F31) Knob 8828 Levers 8828FL SL8828FL 8828RL			N/A	(F111) 5428LN 5328LN 4728LN 4628LN 4328LN 6428LN	
Communicating Classroom or Closet Lock	Knob 8829 Levers 8829FL SL8829FL 8829RL			N/A	(F113) 5429LN 5329LN 4729LN 6429LN	
Asylum or Institutional Lock	(F30) Knob 8830-2 Levers 8830-2FL SL8830-2FL 8830-2RL		(F87) 5430		(F87) 5430LN 5330LN 4730LN 6430LN	
Communicating Storeroom Lock		N/A		N/A	(F112) 5439LN 5339LN 4739LN	
Note: Shaded area denotes rigid lever or knob.			Note: Shaded area denotes rigid knob.		Note: Shaded area denotes Free Wheeling lever.	

 Indicator options available for both sectional and escutcheon trim.

Lockset Functions



Function/ Application	(ANSI) Model Nos.	Mortise Locksets	Function/ Application	(ANSI) Model Nos.	Mortise Locksets
Detention Lock	Knob 8831 Lever SL8831FL		Apartment Corridor Door Lock	(F20) Knob 8847 Levers 8847FL SL8847FL 8847RL	
Hotel/Motel Lock	Knob 8832 Levers 8832FL SL8832FL 8832RL		Room Door Lock	(F21) Knob 8860 Levers 8860FL SL8860FL 8860RL	
Exit Lock	Knob 8833 Lever 8833FL 8833RL		Store Door Lock	(F14) Knob 8860-2 Levers 8860-2FL SL8860-2FL 8860-2RL	
All Purpose Lock	8833-2		Dormitory or Storeroom Lock	Knob 8861 Levers 8861FL SL8861FL 8861RL	
All Purpose Lock	Knob 8834 Lever 8834FL 8834RL		Privacy, Bedroom or Bath Lock	(F22) Knob 8862 Levers 8862FL SL8862FL 8862RL	
All Purpose Lock	Knob 8834-2 Lever 8834-2FL 8834-2RL		Bathroom Lock with Indicator	Knob 8864 Levers 8864FL 8864RL	
Exit Lock	Knob 8835 Lever 8835FL SL8835FL 8835RL		Bathroom Lock	Knob 8865 Levers 8865FL SL8865FL 8865RL	
Storeroom Deadbolt	Knob 8840 Levers 8840FL SL8840FL 8840RL		Passage Lock with Indicator	Knob 8866 Levers 8866FL 8866RL	
Note: Shaded area denotes rigid lever or knob.			Dormitory or Exit Lock	(F12) Knob 8867 Levers 8867FL SL8867FL 8867RL	
			Note: Shaded area denotes rigid lever or knob.		

Indicator options available for both sectional and escutcheon trim.

Lockset Functions



Function/Application	ANSI (Grade 1/Grade 2)	Model Number	Deadlocks
Mortise Deadlocks			
Cylinder x Thumbturn Deadbolt operated by key outside, thumbturn inside.	—	352	
Cylinder x Cylinder Deadbolt operated by key outside, key inside.	—	351	
Cylinder x Blank (Rose) Deadbolt operated by key outside only. No inside operation.	—	353	
Blank Plate x Thumbturn Deadbolt operated by thumbturn inside only. No outside operation.	—	354	
Cylinder x Classroom Thumbturn Deadbolt operated by key outside, deadbolt retracted by thumbturn inside. Thumbturn will not project deadbolt.	—	357	
Cylinder x Cylinder & Thumbturn Deadbolt by key outside and inside. Inside thumbturn will retract deadbolt but will not project it.	—	356	

Function/Application	ANSI (Grade 1/Grade 2)	Model Number		Deadbolts
		D100	D200	
Cylindrical Deadbolts				
Cylinder x Thumbturn Deadbolt operated by key outside, thumbturn inside.	E0151/E0152	D111 D112 B-D171 B-D172	D211 D212	
Cylinder x Cylinder Deadbolt operated by key outside, key inside.	E0141/E0142	D121 D122	D221 D222	
Cylinder x Blank (Rose) Deadbolt operated by key outside only. No inside operation.	E0161/E0162	D131 D132	D231 D232	
Blank Plate x Thumbturn Deadbolt operated by thumbturn inside only. No outside operation.	E0191/E0192	D141 D142	D241 D242	
Blank Plate x Cylinder Deadbolt operated by key inside only. No outside operation.	E0101/E0102	D151 D152	D251 D252	
Cylinder x Classroom Thumbturn Deadbolt operated by key outside, deadbolt retracted by thumbturn inside. Thumbturn will not project deadbolt.	E0171/E0172	D161 D162 B-D181 B-D182	D261 D262	
Indicator x Thumbturn Deadbolt operated by thumbturn inside, emergency override key outside. Outside indicator displays "Occupied" when deadbolt thrown or "Vacant" when deadbolt retracted.	N/A	N/A	D291 D292	

Deadbolt Model Number Description

D	X	X	X
Model Number	Grade	Function	Backset "1" = 2-3/8", "2" = 2-3/4"



Exit Devices

7000 Series Architectural Exit Devices

Yale® 7000 Series Exit Devices deliver an unparalleled combination of durability, breadth of line, innovation and aesthetics. With an architecturally inspired design that features simple clean lines, both our wide and narrow stile devices are visually appealing and bring gracious totality to the entire line of Yale locks and hardware.



Available with Motorized Electric Latch Retraction. Delivering a quiet, smooth operation for convenient, hassle-free egress using 86% less power consumption during retraction than solenoid devices.



7100 Series Exit Devices

A conventional exit device used for single swing doors or pairs of doors of metal, wood or composite construction.

Types

- Rim SquareBolt® Devices (type 28)
- Rim Pullman Bolt Devices (type 1)
- Surface Vertical Rod Devices (type 2)
- Concealed Vertical Rod Devices (types 7 and 8)
- Mortise Devices (type 3)

Features

- Certified ANSI/BHMA A156.3 Grade 1 exit hardware 
- UL/cUL listed for fire labeled or panic exit doors
- Windstorm certified (refer to local codes)  Hurricane
- Outside trim fits stock 161 door preps, escutcheon outside fitting stock 86 door preps
- Surface and concealed vertical rod devices are available in Less Bottom Rod varieties
- Double cylinder devices are available for Rim SquareBolt, Rim Pullman and Mortise varieties
- Available with complete range of electrified options, including REX, electric dogging, outside trim monitoring, latch pullback, bolt status monitoring or delayed egress
- Available in 16 standard finishes
- 5-year mechanical warranty





7200/7200M Series Exit Devices

The 7200M(F) rim exit device provides the appearance of a narrow stile rim exit device for use on wide stile or flush doors. Using the 7200M(F) with narrow stile trim provides design continuity and pleasing aesthetics when matching exit devices for inside doors to outside narrow stile doors.

Types

- Rim SquareBolt Devices (type 28)
- Rim Pullman Bolt Devices (type 4)
- Surface Vertical Rod Devices (type 5)
- Concealed Vertical Rod Devices (types 6 and 8)

Features

- Certified ANSI/BHMA A156.3 Grade 1 exit hardware 
- UL/cUL listed for fire labeled (7200M) or panic exit doors
- Windstorm certified (refer to local codes)  Hurricane
- Optional removable mullions, keyed removable mullions, raised molding clearance kits and custom specialties are all available
- Available with complete range of electrified options, including REX, electric dogging, outside trim monitoring, latch pullback, bolt status monitoring or delayed egress
- Available in 16 standard finishes
- 5-year mechanical warranty





6000 Series Commercial Exit Device

With a full range of functions and options and ANSI Grade 1 certification, the Yale® 6000 Series Exit Devices provide the right security for your commercial facility.

Types

- Rim SquareBolt® Devices (type 5)
- Rim Pullman Bolt Devices (type 0)
- Surface Vertical Rod Devices (type 7)
- Concealed Vertical Rod Devices (type 6)
- Mortise Devices (type 3)



6100-A-ALR emergency exit device features red screenprinted pushpad. See 6000 Series catalog for more information.

Features

- ANSI/BHMA A156.3 Grade 1 certified 
- UL/cUL listed for fired rated or panic doors
- Available in 13 mechanical functions
- Available in standard or decorative lever designs
- Available in 7 standard finishes
- 10 year warranty





2100 Series Flatbar Exit Devices

It's no secret that the 2100 Series Flatbar Exit Device has a reputation as the right choice for meeting the rigors of demanding industry segments.

Types

- Rim SquareBolt® Devices (type 28)
- Rim Pullman Bolt Devices (type 1)
- Surface Vertical Rod Devices (type 2)
- Concealed Vertical Rod Devices (types 7 and 8)

Features

- Certified ANSI/BHMA A156.3  Grade 1 exit hardware
- UL/cUL listed for fire labeled or panic exit doors
- Windstorm certified (refer to  Hurricane local codes)
- Optional removable mullions, keyed removable mullions, Torx® security screws and custom specialties are all available
- Available in 8 finishes
- 3-year mechanical warranty





Exit Devices

1800 Series Flatbar Exit Devices

1800 Series Exit Devices are the ideal choice for a wide variety of commercial applications where consistent quality, ease of use and installation are required.

Types

- Rim Pullman Bolt Devices (type 1)
- Surface Vertical Rod Devices (type 2)

Features

- Certified ANSI/BHMA A156.3  Grade 1 exit hardware
- UL/cUL listed for fire labeled or panic exit doors
- Outside trim fits stock 161 door preps, escutcheon outside fitting stock 86 door preps
- Available in 8 finishes
- 3-year mechanical warranty



1500 Series Traditional Exit Devices

Traditional exit devices for compliance with the exit and access demands of today's codes, where it is important to maintain the architectural lines of yesterday.

Types

- Rim Pullman Bolt Devices (type 1)
- Surface Vertical Rod Devices (type 2)
- Concealed Vertical Rod Devices (type 8)
- Mortise Devices (type 3)









Features

- Certified ANSI/BHMA A156.3  Grade 1 exit hardware
- UL listed for fire labeled or panic exit doors
- Mortise devices available with fail safe or fail secure options
- Outside trim options available for most functions
- Optional removable mullions, keyed removable mullions, Torx® security screws and custom specialties are all available
- Available in 15 standard finishes
- 1-year mechanical warranty



Exit Device Functions



Series	Application	Rim Pullman Bolt	Rim SquareBolt®	Surface Vertical Rod	Concealed Vertical Rod		Mortise
					Metal Doors	Wood Doors	
7100	 Flush or Wide Stile Doors	Panic: 7100 7100-2 Fire: 7100F 7100F-2	Panic: 7150 7150-2 7150WS Fire: 7150F 7150F-2 7150FWS	Panic: 7110 7170* 7170WS Fire: 7110F 7170F* 7170WS	Panic: 7120 7160* Fire: 7120F 7160F*	Panic: 7160* Fire: 7160F*	Panic: 7130 7130-2 Fire: 7130F 7130F-2
7200	 Narrow Stile Doors	Panic: 7200	Panic: 7250	Panic: 7210	Panic: 7220	—	—
7200M	 Flush or Wide Stile Doors	Panic: 7200M Fire: 7200MF	Panic: 7250M 7250MWS Fire: 7250MF 7250MFWS	Panic: 7210M Fire: 7210MF	Panic: 7220M Fire: 7220MF	—	—
6100	 Wide Stile Doors	Panic: 6100-2 Fire: 6100F-2	Panic: 6150 6150-2 6150WS Fire: 6150F 6150F-2 6150FWS	Panic: 6170* 6170WS Fire: 6170F* 6170WS	Panic: 6160* Fire: 6160F*	Panic: 6160* Fire: 6160F*	Panic: 6130 6130-2 Fire: 6130F 6130F-2
6200	 Narrow Stile Doors	Panic: 6200	Panic: 6250	Panic: 6210	Panic: 6220	—	—
2100	 Flush or Wide Stile Doors	Panic: 2100 2100WS Fire: 2100F 2100FWS	Panic: 2150 2150WS Fire: 2150F 2150FWS	Panic: 2110 2170* Fire: 2110F 2170F*	Panic: 2120 2160* Fire: 2120F 2160F*	Panic: 2160* Fire: 2160F*	—
1800	 Flush or Wide Stile Doors	Panic: 1800 Fire: 1800F	—	Panic: 1810 Fire: 1810F	—	—	—
1500	 Flush or Wide Stile Doors	Panic: 1500 Fire: 1500F	—	Panic: 1510 Fire: 1510F	Panic: 1520 Fire: 1520F	—	Panic: 1530 Fire: 1530F

*Less Bottom Rod (LBR) option available (F90).



Exit Device Trim

Entry functions, for doors equipped with Yale® exit devices, are provided by trim with mechanisms mortised into the doors, and exposed components in architectural finishes. Yale keying systems, as well as other keying, are easily integrated.











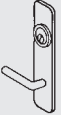





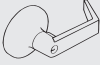

Cylinders: Brass, 6-pin, keyed-random cylinder with two keys furnished standard, 7-pin available to order. For other cylinder and keying options, see page 29.

Warranty: 5-year mechanical for all 600 series trims.

 **ADA compliance** is maintained when Yale® exit devices are used with lever handle or pull trims.

Options include outside cylinder only and decorative lever handles

 **Vandal-Resistant Free Wheeling** lever action offers protection against forced entry, lockouts, and damage to the hardware.

Trim Series	Device Series	Trim Functions	Remarks
 500F Narrow Escutcheon	7200 7200M 6200	F02, F03, F08, F09 F11, F12 Passage Blank Plate	 ADA Pull Access  Vandal Resistant Lever Action
 480F 510 Narrow Escutcheon With Pull	7200 7200M 6200	F02, F03, F05, F06 F11, F12, F15, F16 Passage Blank Plate	 ADA Pull Access
 420 (Rim, V.R.) 620F (Rim, V.R.) 650F (Mortise) 350F (Mortise) Full Escutcheon	7100 6100 2100 1800	F02, F03, F08, F09, F14 Passage Blank Plate	 ADA Pull Access  Vandal Resistant Lever Action (Rim V.R. Only)
	1500		
 630F (Rim, V.R.) 660F/670F (Mortise) Full Escutcheon	7100 6100 2100 1500	F02, F03, F05, F06, F15 Passage Blank Plate	 ADA Pull Access
 440F 540F 580F Rose	7100 6100 2100 1800	F02, F03, F08, F14 Passage	 ADA Pull Access  Vandal Resistant Lever Action
 210F Plate/Finger Pull	2100	F02, F03	Baked Enamel Finishes
 603F Full Escutcheon with Thumbturn	7100 2100	F08, F09, F14 Passage	Rim, SVR, CVR for use with pull by others
 480F Narrow Escutcheon with Offset Pull	7200 7200M 6200	F02, F03	 ADA Pull Access
 680F Full Escutcheon with Offset Pull	7100	F02, F03	 ADA Pull Access

Exit Device Trim



Lever Trim Designs

			
Arcadia AR	Augusta AU	Carmel CR	Jefferson JN
			
Monroe MO	Pacific Beach PB	Pinehurst PN	Virginia VI

Designer Trim Design



Hampton HA

Reflections® Decorative Levers

See Page 3 For Reflections Decorative Levers.



Cylinders and Keying/Security Cylinders

Cylinders And Keying

All Yale® locksets are available in a wide choice of cylinder and keying options:

Cylinder Types and Options:

- Fixed Core (standard)
- Large Format Interchangeable Core
- Small Format Interchangeable Core
- Conventional Keyways
- Protected Keyways
- Security Cylinders (Not UL437 Certified)
- High Security Cylinders (UL437 Certified)

Keying Options:

- Keyed Different (KD)
- Keyed Alike (KA)
- Master-Keyed (MK)
- Grand Master-Keyed (GMK)
- Great Grand Master-Keyed (GGMK)
- Construction Keying (CMK)

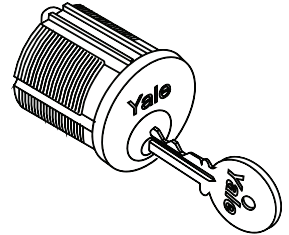

Interchangeable Cores

Yale® cylinders with interchangeable cores allow your master key systems to be flexible. With the special "Control" key any cylinder can have its core interchanged quickly. Any Yale core can be interchanged into any other Yale lock provided it has a interchangeable core. As a result, security for any given lock can be changed in a matter of minutes. Yale interchangeable core cylinders can be used throughout the entire master key system. They can be used selectively within the system along with Yale fixed core cylinders. There are two types of interchangeable cores that are offered by Yale.

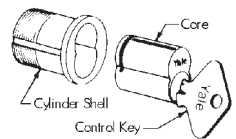

1. Large Format (LFIC) - These cores are available in both standard Yale cylinders and also Yale KeyMark® cylinders. Note that standard Yale cylinders and Yale KeyMark cylinders cannot be keyed to the same master key system.
2. Small Format (SFIC) - Yale offers SFIC cores in Yale KeyMark and Best® keyways A, B, C, D, E, F, G, H, J, K, L and M. Best® keyway cores can be provide keyed random, master keyed or uncombined. Yale will provide master keying to new key system only. Systems can be provided using the A2 or A4 pinning specification and can not be tied into any conventional or Yale KeyMark key systems. All cylindrical lock small format preparations and 1-3/8" housings accept either 6- or 7-pin cores.



Yale® KeyMark®

For those applications requiring protected key control, Yale® KeyMark® cylinders guard against unauthorized key duplication. The Yale KeyMark Security Leg® keyway feature increases resistance against picking and impressioning and can easily retrofit into existing systems. Cylinders include mortise, rim, key-in-lever, key-in-knob, auxiliary, and interchangeable core. IC core is available in both large and small formats. All formats can be tied into one master key system.



Security/High Security Cylinders

Yale® security/high-security cylinders contain two independent locking mechanisms. The first is a traditional 6 or 7-pin tumbler mechanism with spool drivers for increased picking resistance.

The second is a 5-tumbler rotating disc mechanism with sidebar engagement. The rotating discs are spring loaded and block the bottom of the keyway. Only a specially cut key will move the discs and allow entrance of the key. This key has a special side biting and must align all five discs perfectly before the cylinder plug will rotate to open the lock.



Door Controls



5800 Series Cast Iron Door Closers

Yale® 5800 Series Cast Iron Door Closers are ideal for commercial applications where ease of use, installation and aesthetics are required at an economical price.

The 5800 Series features rugged construction, adjustments for backcheck, closing and latch speed, rack and pinion operation and a variety of arm options.

Features

- Adjustable spring sizes 1 through 6
- Non-handed
- Cast iron
- Tri-packed: regular, parallel or top jamb mounting
- Adjustable backcheck valve
- Adjustable closing speed valve
- Adjustable latching speed valve
- Full plastic cover
- Spring power adjustment
- Hold-open and heavy-duty arms arm configurations
- Sleeve nuts included with all models
- Optional - Delayed action
- 10-year limited warranty



Compliance Standards

- Certified for ANSI/BHMA A156.4 Grade 1 
- UL and cUL listed. This includes compliance to UL10C.
- Meets requirements for Americans with Disabilities Act (ADA) and ANSI/BHMA A117.1 

4400 Series Institutional Door Closers

The 4400 Series offers customers the ideal combination of superior performance, quality and strength.

Features

- Adjustable spring sizes 1 through 6
- Tri-pack standard (regular arm, top jamb and parallel arm mounting)
- Non-handed
- Standard, separate and independent, latch, sweep and backcheck intensity valves
- 2-3/16" (56mm) projection
- Staked valves
- All standard arm applications allow doors to swing 180°, conditions permitting
- 25-year limited warranty



Optional Features

- Metal cover
- Corrosion-resistant model (specify 4400S)
- Delayed action
- Enhanced backcheck
- Heavy-duty arms available: Regular Rigid, Parallel Rigid, Holder/Stop, Holder/Stop Spring and UNI Stop™
- Slide track – push or pull mounting

Compliance Standards

- Certified ANSI/BHMA A156.4, Grade 1 
- UL/cUL listed
- UL10C compliant for positive pressure
- Meets requirements for Americans with Disabilities Act (ADA) and ANSI/BHMA A117.1 



3000 Series Architectural Door Closers

The 3000 Series offers the perfect combination of reliability, appearance and durability in today's market.

Features

- Adjustable spring sizes 1 through 6
- Tri-pack standard (regular arm, top jamb or parallel arm mounting)
- Non-handed
- Staked valves
- Standard, separate and independent, latch, sweep and backcheck intensity valves
- 2-1/8" (54mm) projection (standard covers)
- All standard arm applications allow doors to swing 180°, conditions permitting
- 25-year limited warranty
- Metal, architectural plastic or architectural metal covers
- Delayed action
- Heavy-duty arms available: Parallel Rigid, Holder/Stop, Holder/Stop Spring and UNI Stop™

Compliance Standards

- Certified ANSI/BHMA A156.4, Grade 1 
- UL/cUL listed
- UL10C compliant for positive pressure
- Meets requirements for Americans with Disabilities Act (ADA) and ANSI/BHMA A117.1 



2700 Series Architectural Door Closers

The 2700 Series features rugged construction, adjustments for backcheck, closing and latch speed, and rack and pinion operation.

Features

- Adjustable spring sizes 1 through 6
- Non-handed
- Aluminum
- Tri-packed: regular, parallel or top jamb mounting
- Adjustable backcheck valve
- Adjustable closing speed valve
- Adjustable latching speed valve
- Full plastic cover
- Spring power adjustment - adjust with adjustable wrench
- Hold-open and heavy-duty arms available
- Sleeve nuts included with all models
- Optional fasteners:
 - Thrubolts and grommet nuts
- Optional - Delayed action
- 10-year limited warranty

Compliance Standards

- Certified ANSI/BHMA A156.4, Grade 1 
- UL/cUL listed
- UL10C compliant for positive pressure
- Meets requirements for Americans with Disabilities Act (ADA) and ANSI/BHMA A117.1 





51 Series Industrial Door Closers

The 51 series is ideal for use with aluminum store front doors and frames, yet they also complement wood or metal door installations.

Features

- Non-handed
- Staked valves
- Standard, separate and independent, latch, sweep and backcheck intensity valves
- 2-7/8" (73mm) projection
- 15-year limited warranty

Optional Features

- Delayed action (in lieu of backcheck)
- Molded plastic cover

Compliance Standards

- Certified ANSI/BHMA A156.4, Grade 1 
- UL/cUL listed
- UL10C compliant for positive pressure
- Meets requirements for Americans with Disabilities Act (ADA) and ANSI/BHMA A117.1 (51BF) 



	51	51BF
Adjustable spring sizes 3 through 6	X	
Adjustable spring sizes 1 through 4		X
Tri-pack standard (regular arm, top jamb or parallel arm mounting)	X	X

1100 Series Industrial Door Closers

The 1100 Series features rugged construction, adjustments for closing and latch speed, and rack and pinion operation.

Features

- 1101BF (non-hold open) and 1111BF (hold open) door closers are adjustable spring sizes 1 through 4
- 1104BC (non-hold open) door closers are spring size 4
- Non-handed
- Full rack and pinion
- Aluminum
- Tri-packed: regular, parallel or top jamb mounting
- Adjustable backcheck valve
- Adjustable closing speed and latching speed valves
- Auxiliary door stop required
- Sleeve nuts included with all models
- 5-year limited warranty

Optional Features

- Cover (order separately)

Compliance Standards

- UL/cUL listed
- 1101BF/1111BF - designed to meet requirements for ANSI/BHMA A156.4 Grade 1. Door closers meet handicapped requirements for light to medium weight interior doors. 
- 1104BC - designed to meet requirements for ANSI/BHMA A156.4 Grade 2



Door Controls



YDC200 Economy Door Closers

The YDC200 Series is a no-fuss, economical option for aluminum storefront settings and other high volume applications.

Features

- Adjustable spring size 1-4 (YDC201) or fixed spring size 4 (YDC204)
- Tri-packed: regular, top jamb, or parallel mounting options
- Non-handed
- Cast aluminium body and threaded adjustable arm
- Rack & pinion design
- Independent latch, sweep, and backcheck intensity valves
- Available in two finishes 689 & 690
- 5 year limited warranty
- Designed to meet Grade 1 specifications



Electrified Products



Yale offers a range of new and exciting electromechanical products to meet a variety of applications, ensuring a distinct Yale advantage. These products include nexTouch® Keypad Access Lock, alarms and alarmed devices, and electrified mortise and cylindrical locking products. Yale's electrified products incorporate the highest level of security available with the added flexibility and security of remote electrical control. Electrified hardware is ideal for interfacing with access control, security and fire alarm systems.

Electrolynx®

What normally took an hour or more to connect now takes minutes. All Yale® electrified hardware is equipped with Electrolynx® connectors. As a standard feature, these connectors link power from the incoming source to electrified locking products, including hinges, locks, exit devices, magnetic holders and strikes.

Note: Electrified door hardware with Electrolynx® connectors require a compatible hinge.

Mortise Locksets

- Certified ANSI/BHMA A156.13 Series 1000, Grade 1
- UL10B Listed for 3-hour fire-rated openings
- Utilizes 8800 lockset
- Continuous duty integral solenoid
- Available in 12 or 24VDC
- Fail Safe or Fail Secure Operation
- Request to Exit (REX), Latchbolt Monitoring (LBM), Deadbolt Monitoring (DBM) , Integrated Total Security (ITS) options available

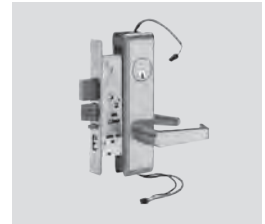

Cylindrical Locksets

- Certified ANSI/BHMA A156.2 Series 4000, Grade 1 and 2
- UL Listed
- Utilizes 5400LN, 5300LN or 4700LN lockset
- Free Wheeling lever mechanism
- Available in 12 or 24V
- External rectifier accepts AC or DC voltage
- Mechanical cylinder override
- Fail Safe or Fail Secure Operation
- Request to Exit (REX) option available (5400LN series only)





Mortise And Cylindrical Functions

Fail Safe – Locked when power is on and unlocked when power is off.

Function Description	Mortise Model Number	Cylindrical Model Numbers
<ul style="list-style-type: none"> Power on – outside lever locked Inside lever always free No key override 	8880	4780LN 5380LN 5480LN
<ul style="list-style-type: none"> Power on – both levers locked No key override 	8884	N/A
<ul style="list-style-type: none"> Power on – outside lever locked Mechanical key override by outside 	8890	4790LN 5390LN 5490LN
<ul style="list-style-type: none"> Power on – both levers locked Mechanical key override by both sides 	8894-2	N/A
<ul style="list-style-type: none"> Power on – outside lever locked Deadbolt by key outside, thumbturn inside Mechanical key override by outside 	8896	N/A
<ul style="list-style-type: none"> Power on – outside lever locked Deadbolt by key both sides Mechanical key override by both sides 	8896-2	N/A
<ul style="list-style-type: none"> Power on – both levers locked Deadbolt by key outside, thumbturn inside Mechanical key override by outside 	8898	N/A
<ul style="list-style-type: none"> Power on – both levers locked Deadbolt by key both sides Mechanical key override by both sides 	8898-2	N/A

Fail Secure – Unlocked when power is on and locked when power is off.

Function Description	Mortise Model Number	Cylindrical Model Numbers
<ul style="list-style-type: none"> Power off – outside lever locked Inside lever always free No key override 	8881	4781LN 5381LN 5481LN
<ul style="list-style-type: none"> Power off – both levers locked No key override 	8885	N/A
<ul style="list-style-type: none"> Power off – outside lever locked Mechanical key override by outside 	8891	4791LN 5391LN 5491LN
<ul style="list-style-type: none"> Power off – both levers locked Mechanical key override by both sides 	8895-2	N/A
<ul style="list-style-type: none"> Power off – outside lever locked Deadbolt by key outside, thumbturn inside Mechanical key override by outside 	8897	N/A
<ul style="list-style-type: none"> Power off – outside lever locked Deadbolt by key both sides Mechanical key override by both sides 	8897-2	N/A
<ul style="list-style-type: none"> Power off – both levers locked Deadbolt by key outside, thumbturn inside Mechanical key override by outside 	8899	N/A
<ul style="list-style-type: none"> Power off – both levers locked Deadbolt by key both sides Mechanical key override by both sides 	8899-2	N/A



Exit Devices

The Yale® 7000 and 6000 Series Exit Devices offer a complete range of electrical options:

- Electric Latch Retraction
- Electric Dogging
- Mortise Device Trim Control
- Touchbar Monitor or Signaling
- Outside Trim Monitor or Signaling
- Bolt Position Monitor or Signaling
- Delayed Egress
- Electric Trim Control
- Alarm

Electrified exit devices may be integrated into the monitoring security and alarm systems of most buildings.



Exit Device Option Descriptions

A	Alarm Option	O	Trim Monitor
A-ALR	Alarm option with red screenprinted pushpad	P	Latch Retraction
B	Touchbar Monitor	S	Bolt Monitor
D	Delayed Egress	SAFE	Fail Safe Operation (Mortise)
G	Electric Dogging	SECURE	Fail Secure Operation (Mortise)
H*	Security Package (DPS)	690F	Fail Safe Electrified Trim
MELR	Motorized Electric Latch Retraction	691F	Fail Secure Electrified Trim

Note: Any combination of the following options cannot be ordered together:
1) P, G, or D 2) B or A 3) D, B or A
***Only available for rim and SquareBolt® Devices when used with Delayed Egress option.**

Electrified Options Chart

Model #	Exit Device Description	A	A-ALR	B	G	H	MELR*	O	P*	S	SAFE	SECURE	690F	691F
6100(F)	Rim Exit Device (Wide)	x	x	x	x	x		x	x	x			x	x
7100(F)	Rim Exit Device (Wide)	x		x	x	x	x	x		x			x	x
6110(F)	Surface Vertical Rod (Narrow)	x		x	x			x	x	x			x	x
7110(F)	Surface Vertical Rod (Wide)	x		x	x		x	x		x			x	x
6120(F)	Surface Vertical Rod (Narrow)	x		x	x			x	x	x			x	x
7120(F)	Concealed Vertical Rod (Wide)	x		x	x		x	x		x			x	x
6130(F) & 7130(F)	Mortise Exit Device (Wide)	x		x	x		x	x	x	x	x	x		
6150(F) & 7150(F)	Rim SquareBolt® Device (Wide)	x		x	x	x	x	x	x	x			x	x
6160(F) & 7160(F)	Concealed Vertical Rod (Wide)	x		x	x		x	x	x	x			x	x
6170(F) & 7170(F)	Surface Vertical Rod (Wide)	x		x	x		x	x	x	x			x	x
6200 & 7200(M)(F)	Rim Exit Device (Narrow)	x		x	x		x		x	x				
6210 & 7210(M)(F)	Surface Vertical Rod (Narrow)	x		x	x		x		x	x				
6220 & 7220(M)(F)	Concealed Vertical Rod (Narrow)	x		x	x		x		x	x				
6250 & 7250(M)(F)	Rim SquareBolt® Device (Narrow)	x		x	x		x		x	x				

*MELR available for 7000 Series only; P available for 6000 Series only

Stand-Alone Door Alarm

The SDA16 stand-alone battery operated door alarm is designed to continually monitor the status of a door. When the door is opened without authorization, an alarm is triggered to alert the security violation. This alarm features a Peizo horn which blasts a deafening 105+ decibels to alert the violation.



This unit is ideal for emergency doors as well as stairwell doors and rear exit doors in retail environments. The unit, which can also be hardwired, easily complements existing hardware, making any opening alarmed. The SDA16 door alarm is typically mounted on the interior of the door frame or door and is paired with a magnet mounted on the opposing side of the door gap.

Remote Mounting

The SDA16 can be installed remotely from the door by attaching the contacts to the door and frame. The unit can be installed up to 6 feet from the door. This provides the ideal solution for circumstances where exposure to weather may be an issue. To order specify "SDA16XL".



Note: Actual wire length is 6 feet.

nexTouch® Keypad Locks



Yale nexTouch locks combine a modern look and innovative access control technology with an array of bold new features, offering an attractive access control solution in many applications. With a heavy-duty design and ANSI/BHMA Grade 1 certification, nexTouch provides durable and reliable security in multiple platforms to a range of commercial facilities including offices, retail and multi-family facilities.

Standalone Keypad

Great for restrooms, offices, storage closets and more, nexTouch as a standalone keypad is easy to install, program, and manage access with PIN codes.



Data-on-Card

In new construction or retrofit projects for multi-family facilities, the data-on-card functionality of nexTouch pairs with Yale Accentra™ software for use with key cards or fobs.



Wireless

The perfect solution for small business, nexTouch allows wireless integration of the lock into new or existing commercial automation systems.



Features

- Choice of capacitive touchscreen or tactile pushbutton keypad
- Ergonomic, easy-to-use design
- Keyless entry and management
- Access with PIN codes
- Voice-guided programming in 3 languages
- Privacy feature with Door Position Switch
- 9V battery power backup feature
- Low battery indicator
- Three volume modes
- Certified ANSI/BHMA Grade 1 **BHMA CERTIFIED**
- UL/cUL listed for use on fire doors
- ADA compliant and decorative levers available
- Optional cylinder/key override – full range of Yale® 6-pin conventional, protected and security cylinders available including large and small format interchangeable core
- Weather resistant
- 3-year limited warranty

nexTouch® Keypad Locks



Cylindrical

Functions

Model Number	Keypad	Function
NTB630	Pushbutton	Without cylinder override
NTB640	Touchscreen	
NTB610	Pushbutton	With cylinder override
NTB620	Touchscreen	



Trim



Sectional Mortise



Functions

Model Number	Keypad	Function
NTM630	Pushbutton	No deadbolt without cylinder override
NTM640	Touchscreen	
NTM610	Pushbutton	No deadbolt with cylinder override
NTM620	Touchscreen	
NTM635	Pushbutton	Deadbolt without cylinder override
NTM645	Touchscreen	
NTM615	Pushbutton	Deadbolt with Cylinder override
NTM625	Touchscreen	



Trim*

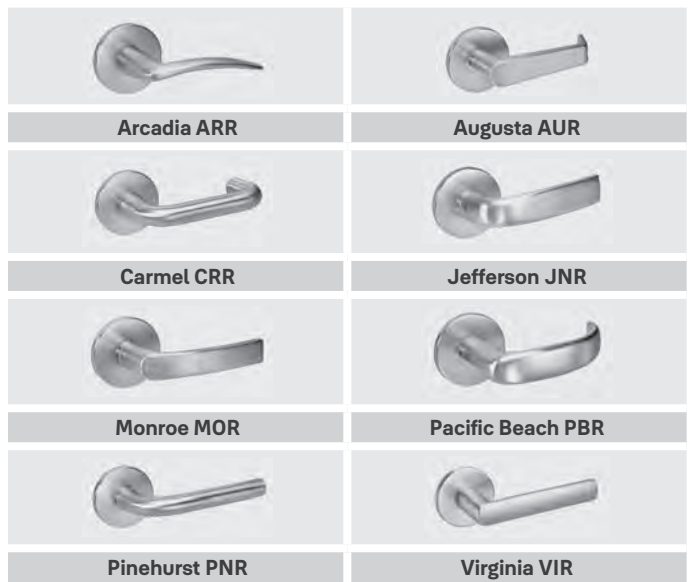

*Full line of Reflections® decorative levers (except Spree) also available, see page 3.

nexTouch® Keypad Locks



Exit Trim

Functions

Model	Keypad	Function
NTT610	Pushbutton	Exit trim, key override
NTT620	Touchscreen	Exit trim, key override



Trim



Compatible Exit Devices

Thanks to its patented adjustable mounting posts, Yale nexTouch exit trim is compatible with several makes and models of exit devices right out of the box, without the need for separate mounting hardware. Check the chart below to see if yours is a fit.

Manufacturer	Model/Series Number*
Arrow	3880, S1250
Corbin Russwin	ED5200, ED5200S
Dorma	9300
Falcon®	24, 25
SARGENT	8800
Von Duprin®	98, 99
Yale	1800, 2100, 6000, 7000

*Compatible with rim device only. Please contact Technical Product Support for more information.

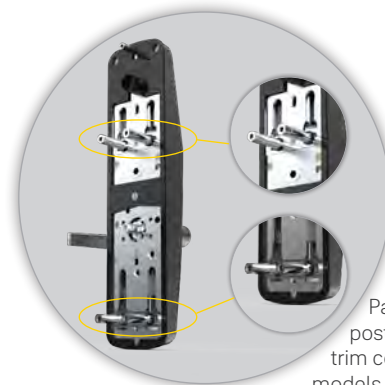

Patented adjustable mounting posts make the nexTouch exit trim compatible with many exit device models (see chart at left).



Trusted every day

Phone

1-855-557-5078

Customer Service Email

customerservice.yale@assaabloy.com

Technical Product Support Email

techsupport.yale@assaabloy.com

Order Entry Email

orders.yaleus@assaabloy.com

Fax

1-800-338-0965

Website

www.yalecommercial.com

Contact Us

U.S.A.

Yale Locks & Hardware

Address: 225 Episcopal Road

Berlin, CT 06037-4004

Tel: 1-800-438-1951

Fax: 1-800-338-0965

yalecommercial.com

Canada:

ASSA ABLOY Door Security Solutions Canada

Address: 160 Four Valley Drive

Vaughan, Ontario L4K 4T9

Tel: 1-800-461-3007

Fax: 1-800-461-8989

assaabloydss.ca

International:

ASSA ABLOY Americas International

Tel: 1-905-821-7775

Fax: 1-905-821-1429

assaabloyai.com

MicroShield®

As part of their promise to provide innovative solutions to their customers, certain ASSA ABLOY Group brands offer the MicroShield® technology, a silver-based antimicrobial coating designed to inhibit the growth of bacteria.

Microshield® is a registered trademark of ASSA ABLOY Access and Egress Hardware Group, Inc.



The Agion antimicrobial is not intended as a substitute for good hygiene. Coated products must still be cleaned to ensure the surfaces will be free of destructive microbes. ASSA ABLOY makes no representations or warranties, express or implied, as to the efficacy of the Agion antimicrobial. A copy of the Agion warranty is available upon request. Agion is a registered trademark of Agion Technologies, Inc., Wakefield, MA, USA.

THE YALE BRAND, with its unparalleled global reach and range of products, reassures more people in more countries than any other consumer locking solution.

THE ASSA ABLOY GROUP is the world's leading manufacturer and supplier of locking solutions, dedicated to satisfying end-user needs for security, safety and convenience.

Yale Commercial is a business associated with ASSA ABLOY Access and Egress Hardware Group, Inc., an ASSA ABLOY Group company. Copyright © 1999-2021, ASSA ABLOY Access and Egress Hardware Group, Inc. All rights reserved. Reproduction in whole or in part without the express written permission of ASSA ABLOY Access and Egress Hardware Group, Inc. is prohibited. Patent pending and/or patent www.assaabloydss.com/patents.



QuickShip

5-Day Shipping Program



Table of Contents

QUICKSHIP POLICY	3	EXIT DEVICES	
KEY BLANKS AND CYLINDER COMPONENTS	4	7000 Series Architectural	48
8800 SERIES GRADE 1 MORTISE LOCKS		2100 Series Flatbar	49-50
Complete with Lever & Rose Trim	5	1800 Series Flatbar	51-52
Complete with Reflections® Lever & Rose Trim	6-7	EXIT DEVICE TRIM AND ACCESSORIES	
Complete Electrified with Lever & Rose Trim	8	210F Series Plate Trim	53
Trim Packs	9	440F Series Rose Trim	54-55
Lock Bodies Only	10	540F Series Rose Trim	56-57
Cylinders and Accessories	11	420F Series Escutcheon Trim	58-59
GRADE 1 CYLINDRICAL LEVER LOCKS		620F Series Escutcheon Trim	60-62
5400LN Series	12-15	630F Series Escutcheon Trim	63
5400LN Electrified Series	16	690F Series Electrified Trim	63
4700LN Series	17-20	Removable Mullions	64
GRADE 2 CYLINDRICAL LEVER LOCKS		Cylinders	65
5300LN Series	21-24	Miscellaneous Hardware and Accessories	66
5300LN Electrified Series	25	DOOR CLOSERS AND OPERATORS	
4600LN Series	26-31	5800 Series Cast Iron	67
GRADE 2 TUBULAR LEVER LOCKS		4400 Series Institutional	68
4300LN Series - 2-3/4" Backset	32-33	3000 Series Architectural	69
4300LN Series - 2-3/8" Backset	34-35	2700 Series Architectural	70
TUBULAR DECORATIVE LEVER LOCKS		51 Series Industrial	71
RL Series	36	1100 Series Industrial	72
GRADE 1 CYLINDRICAL KNOB LOCKS		Accessories	73
5400CK Series	37	QUICKSHIP ORDER FORM	74-75
GRADE 2 CYLINDRICAL KNOB LOCKS			
4600 Series	38		
CYLINDRICAL/TUBULAR CYLINDERS AND ACCESSORIES	39-40		
AUXILIARY LOCKS			
D Series Cylindrical Deadbolts, Grade 1	41-43		
D Series Cylindrical Deadbolts, Grade 2	43-45		
Mortise Deadlocks	46		
Rim/Cabinet Locks	47		



Policy

Order Form

Please use the form on pages 81-82 when placing orders for Yale® products. Copies of this form can also be printed from our website (www.yalelocks.com).

Part Numbers

QuickShip part numbers must be included on the order form. Orders listing model numbers only may be processed as factory orders.

Mixed Orders

QuickShip product orders and factory orders must be submitted on separate order forms. Any order received having both factory and QuickShip products will be processed as a factory order and shipped from the factory at normal lead times.

Quotes

Quote number must be included with the purchase order. Orders without this information will be processed at standard buying programs.

Minimum Order

Minimum invoice is \$250 net product value.

Lead Time

Lead time is 5 delivery days from receipt of order. (Consult the current Yale® Price Book for a complete list of Terms & Conditions regarding delivery.) We reserve the right to limit quantities.

Freight

All orders are shipped FOB factory/warehouse, except as expressly provided below. When delivered to the Transportation Company, the Purchaser assumes the risk of loss or damage in transit.

Customer orders with net product value in excess of \$7,000.00 will be shipped prepaid by the Yale carrier of choice to a single destination point in the United States.

Customer orders with net product value less than \$7,000.00 will be shipped prepaid by the Yale carrier of choice and freight and handling charges will be added to the customer's invoice.

A minimum freight and handling charge of \$15.00 will be charged on orders with net product value of \$400.00 or less.

For orders with net product value greater than \$400.00 and less than \$7,000.00, freight charges will be calculated as a percentage of the net invoice value and will be added to Customer's invoice. The percentage is based on the National U.S. Average On Highway Diesel Fuel Prices as reported by the US Department of Energy in effect at the beginning of each quarter. On the first Monday of each quarter, the new rate will be published on the Yale and Door Security Solutions extranet and will go into effect on the 2nd Monday of the quarter. Please refer to

FINISH CHART

Finishes for *Yale* products are ordered using the ANSI/BHMA finish code.

SPRAYED FINISHES	
FINISH DESCRIPTION	ANSI/BHMA CODE
Aluminum Painted	689
Dark Bronze Painted	690
Light Bronze Painted	691
Dark Bronze Painted	695
Satin Brass Painted	696

the Yale distributor extranet for the rate chart and information on the current freight charge percentage. The percentage in effect at the time of shipment of the order will be charged.

If a customer provides their own freight account number for the freight charges, Yale will apply a handling fee of \$25.00 to the invoice.

Expedited shipping options – If the customer requests an expedited method of shipment such as “Next Day Air” the charges will be prepaid by Yale and the full rate for the service, as published by the carrier, will be added to the customer's invoice.

Packing – Yale will pack, mark and ship the products according to its standard procedures for shipment, unless the parties agree, in writing, that Yale will comply with any special instructions provided by the customer. Special instructions must be submitted, in writing, at time of order placement. Compliance with special instructions may result in an increased price.

Changes/Cancellations

Due to the promptness of delivery, no changes or cancellations can be accepted. The only exception is when we are out of stock.

Prices

All shipments will be made at prices prevailing at time of shipment.

Terms

Invoices dated the 1st through the 15th will be due for 2% discount on the 10th of the following month. Invoices dated the 16th through the 31st will be due for 2% discount on the 25th of the following month. Net immediately thereafter.

Consult the current *Yale* Price Book for pricing information, a complete list of Terms & Conditions and Warranty Information.

For Customer Service Contact:

ASSA ABLOY Door Security Solutions

Customer Service - Monroe

1902 Airport Road

Monroe, NC 28110

Phone: 800-438-1951

Hours of Operation

8:00 am - 4:30pm EST

ALL QUICKSHIP ORDERS MUST BE FAXED TO 800-338-0965. ORDERS CAN ALSO BE SENT BY E-MAIL TO ORDERS@ASSAABLOYDSS-CS.COM.

PLATED FINISHES	
FINISH DESCRIPTION	ANSI/BHMA CODE
Bright Brass, Clear Coated	605
Dark Oxidized Satin Bronze, Oil Rubbed	613
Dark Oxidized Satin Bronze - equivalent	613E
Satin Chrome Plated	626
Satin Stainless Steel	630



Key Blanks And Cylinder Components

KEY BLANKS				
MODEL #	DESCRIPTION	KEY SECTION	QUICKSHIP #	APPROX. WEIGHT (LBS. EACH)
RN11	6-Pin Blank	GA	002817	0.1
RN11	6-Pin Blank	GB	002818	0.1
RN11	6-Pin Blank	GC	002819	0.1
RN11	6-Pin Blank	GD	002820	0.1
RN11	6-Pin Blank	PARA	002815	0.1
RN11	6-Pin Blank	GMK	002825	0.1
KEYING KITS				
SK12	Keying Kit, .019" Step with Plug Follower and Key Gauge		002980	5
R19	Refill Kit for SK12 Keying Kit, .019" Step		002982	1.5
PIN TUMBLERS - .019" STEP				
MODEL #	DESCRIPTION	BITTING #	QUICKSHIP #	APPROX. WEIGHT (LBS. EACH)
351-2	Top Pins	2	002996	0.1
351-3	Top Pins	3	002997	0.1
351-4	Top Pins	4	002998	0.1
451-2	Master Pins	2	002999	0.1
451-4	Master Pins	4	003001	0.1
451-6	Master Pins	6	003003	0.1
451-8	Master Pins	8	003005	0.1
251-0	Bottom Pins	0	002986	0.1
251-1	Bottom Pins	1	002987	0.1
251-2	Bottom Pins	2	002988	0.1
251-3	Bottom Pins	3	002989	0.1
251-4	Bottom Pins	4	002990	0.1
251-5	Bottom Pins	5	002991	0.1
251-6	Bottom Pins	6	002992	0.1
251-7	Bottom Pins	7	002993	0.1
251-8	Bottom Pins	8	002994	0.1
251-9	Bottom Pins	9	002995	0.1
MISCELLANEOUS				
TOOLS & MISC.				
KG1	Key Gauge for .019" and .025 Keys	—	022070	0.1
020	Plug Follower for .51" Plug	—	002984	0.1
021	Tweezers	—	002985	0.1
151	Springs	—	003006	0.1
TEMPORARY CORES AND CUT KEYS				
1210T	Temp. Cores - KA - 6-Pin	PARA	002600	0.2
RN11-T	Change Keys - KA - 6-Pin	PARA	002601	0.1
FN117-T	Control Key - KA - 7-Pin	PARA	002602	0.1
CONTROL KEYS				
FN117-C	Control Key - 0 Bitted - 7-Pin	GA	001766	0.1
FN117-C	Control Key - 0 Bitted - 7-Pin	PARA	001805	0.1

Note: Yale reserves the right to limit quantities
Refer to the end of each product section for available cylinders



Grade 1 Mortise Locks

8800FL SERIES: COMPLETE LOCKSET WITH LEVER & ROSE TRIM



Augusta - AUR



Carmel - CRR



Monroe - MOR



Pacific Beach - PBR

DESIGN	MODEL #	FINISH	HAND	STRIKE	CYLINDER	QUICKSHIP #	APPROX. WEIGHT (LBS. EACH)
8801FL - PASSAGE OR CLOSET LATCH							
AUR	8801FL	626	RH	2815	—	021082	6
CRR	8801FL	626	RH	2815	—	021089	6
MOR	8801FL	626	RH	2815	—	021096	6
PBR	8801FL	626	RH	2815	—	021103	6
8802FL - PRIVACY, BEDROOM OR BATH LOCK							
AUR	8802FL	626	RH	2815	—	021083	6
CRR	8802FL	626	RH	2815	—	021090	6
MOR	8802FL	626	RH	2815	—	021097	6
PBR	8802FL	626	RH	2815	—	021104	6
8805FL - STOREROOM OR CLOSET LOCK							
AUR	8805FL	626	RH	2815	Less Cylinder	021084	6
CRR	8805FL	626	RH	2815	Less Cylinder	021091	6
MOR	8805FL	626	RH	2815	Less Cylinder	021098	6
PBR	8805FL	626	RH	2815	Less Cylinder	021105	6
8807FL - ENTRY LOCK							
AUR	8807FL	626	RH	2815	Less Cylinder	021085	6
CRR	8807FL	626	RH	2815	Less Cylinder	021092	6
MOR	8807FL	626	RH	2815	Less Cylinder	021099	6
PBR	8807FL	626	RH	2815	Less Cylinder	021106	6
8808FL - CLASSROOM LOCK							
AUR	8808FL	626	RH	2815	Less Cylinder	021086	6
CRR	8808FL	626	RH	2815	Less Cylinder	021093	6
MOR	8808FL	626	RH	2815	Less Cylinder	021100	6
PBR	8808FL	626	RH	2815	Less Cylinder	021107	6
8822FL - DORMITORY OR EXIT LOCK							
AUR	8822FL	626	RH	2815	Less Cylinder	021087	7
CRR	8822FL	626	RH	2815	Less Cylinder	021094	7
MOR	8822FL	626	RH	2815	Less Cylinder	021101	7
PBR	8822FL	626	RH	2815	Less Cylinder	021108	7
8847FL - APARTMENT CORRIDOR DOOR LOCK							
AUR	8847FL	626	RH	2815	Less Cylinder	021088	7
CRR	8847FL	626	RH	2815	Less Cylinder	021095	7
MOR	8847FL	626	RH	2815	Less Cylinder	021102	7
PBR	8847FL	626	RH	2815	Less Cylinder	021109	7

Note: Yale reserves the right to limit quantities.
See page 11 for cylinder options



Grade 1 Mortise Locks

8800RL SERIES: COMPLETE LOCKSET WITH REFLECTIONS® LEVER & ROSE TRIM



TB



TQ



TS



TY

DESIGN	MODEL #	FINISH	HAND	ROSE	CYLINDER	QUICKSHIP #	APPROX. WEIGHT (LBS. EACH)
8801RL - PASSAGE OR CLOSET LATCH							
TBR3	8801RL	626	RH	R3	—	021012	7
TQR3	8801RL	626	RH	R3	—	021033	7
TSR3	8801RL	626	RH	R3	—	021047	7
TYR3	8801RL	626	RH	R3	—	021069	7
TYR3	8801RL	626	LH	R3	—	021068	7
8802RL - PRIVACY, BEDROOM OR BATH LOCK							
TBR3	8802RL	626	RH	R3	—	021013	7
TQR3	8802RL	626	RH	R3	—	021034	7
TSR3	8802RL	626	RH	R3	—	021048	7
TYR3	8802RL	626	RH	R3	—	021071	7
TYR3	8802RL	626	LH	R3	—	021070	7
8805RL - STOREROOM OR CLOSET LOCK							
TBR3	8805RL	626	RH	R3	Less Cylinder	021014	7
TQR3	8805RL	626	RH	R3	Less Cylinder	021035	7
TSR3	8805RL	626	RH	R3	Less Cylinder	021049	7
TYR3	8805RL	626	RH	R3	Less Cylinder	021073	7
TYR3	8805RL	626	LH	R3	Less Cylinder	021072	7
8807RL - ENTRY LOCK							
TBR3	8807RL	626	RH	R3	Less Cylinder	021015	7
TQR3	8807RL	626	RH	R3	Less Cylinder	021036	7
TSR3	8807RL	626	RH	R3	Less Cylinder	021050	7
TYR3	8807RL	626	RH	R3	Less Cylinder	021075	7
TYR3	8807RL	626	LH	R3	Less Cylinder	021074	7
8808RL - CLASSROOM LOCK							
TBR3	8808RL	626	RH	R3	Less Cylinder	021016	7
TQR3	8808RL	626	RH	R3	Less Cylinder	021037	7
TSR3	8808RL	626	RH	R3	Less Cylinder	021051	7
TYR3	8808RL	626	RH	R3	Less Cylinder	021077	7
TYR3	8808RL	626	LH	R3	Less Cylinder	021076	7

**Note: Yale reserves the right to limit quantities
See page 11 for cylinder options**



Grade 1 Mortise Locks

8800RL SERIES: COMPLETE LOCKSET WITH REFLECTIONS® LEVER & ROSE TRIM



TB



TQ



TS



TY

DESIGN	MODEL #	FINISH	HAND	ROSE	CYLINDER	QUICKSHIP #	APPROX. WEIGHT (LBS. EACH)
8822RL - DORMITORY OR EXIT LOCK							
TBR3	8822RL	626	RH	R3	Less Cylinder	021017	8
TQR3	8822RL	626	RH	R3	Less Cylinder	021038	8
TSR3	8822RL	626	RH	R3	Less Cylinder	021052	8
TYR3	8822RL	626	RH	R3	Less Cylinder	021079	8
TYR3	8822RL	626	LH	R3	Less Cylinder	021078	8
8847RL - APARTMENT CORRIDOR DOOR LOCK							
TBR3	8847RL	626	RH	R3	Less Cylinder	021018	8
TQR3	8847RL	626	RH	R3	Less Cylinder	021039	8
TSR3	8847RL	626	RH	R3	Less Cylinder	021053	8
TYR3	8847RL	626	RH	R3	Less Cylinder	021081	8
TYR3	8847RL	626	LH	R3	Less Cylinder	021080	8

**Note: Yale reserves the right to limit quantities
See page 11 for cylinder options**



Grade 1 Mortise Locks

8800FL SERIES - COMPLETE ELECTRIFIED LOCKSET WITH LEVER & ROSE TRIM



Augusta - AUR



Carmel - CRR



Monroe - MOR



Pacific Beach - PBR

DESIGN	MODEL #	FINISH	HAND	STRIKE	CYLINDER	QUICKSHIP #	APPROX. WEIGHT (LBS. EACH)
8890FL - 24V FAIL SAFE							
AUR	8890FL	626	RH	2815	Less Cylinder	012808	5
CRR	8890FL	626	RH	2815	Less Cylinder	012810	5
MOR	8890FL	626	RH	2815	Less Cylinder	021008	5
PBR	8890FL	626	RH	2815	Less Cylinder	012819	5
8890FL - 24V FAIL SAFE WITH REQUEST TO EXIT							
AUR	8890FL x REX	626	RH	2815	Less Cylinder	012849	5
CRR	8890FL x REX	626	RH	2815	Less Cylinder	012852	5
MOR	8890FL x REX	626	RH	2815	Less Cylinder	021009	5
PBR	8890FL x REX	626	RH	2815	Less Cylinder	012854	5
8891FL - 24V FAIL SECURE							
AUR	8891FL	626	RH	2815	Less Cylinder	012930	5
CRR	8891FL	626	RH	2815	Less Cylinder	012932	5
MOR	8891FL	626	RH	2815	Less Cylinder	021010	5
PBR	8891FL	626	RH	2815	Less Cylinder	012934	5
8891FL - 24V FAIL SECURE WITH REQUEST TO EXIT							
AUR	8891FL x REX	626	RH	2815	Less Cylinder	012936	5
CRR	8891FL x REX	626	RH	2815	Less Cylinder	012938	5
MOR	8891FL x REX	626	RH	2815	Less Cylinder	021011	5
PBR	8891FL x REX	626	RH	2815	Less Cylinder	012940	5

**Note: Yale reserves the right to limit quantities
See page 11 for cylinder options**



Grade 1 Mortise Locks

8800FL SERIES: TRIM PACKS



Augusta - AUR



Carmel - CRR



Monroe - MOR



Pacific Beach - PBR

DESIGN	FINISH	QUICKSHIP #	APPROX. WEIGHT (LBS. EACH)
8801FL - PASSAGE OR CLOSET LATCH			
AUR	626	021110	3
CRR	626	021111	4
MOR	626	021112	3
PBR	626	021113	3
8802FL - PRIVACY, BEDROOM OR BATH LOCK			
AUR	626	021114	3
CRR	626	021115	4
MOR	626	021116	3
PBR	626	021117	3
8805FL - STOREROOM OR CLOSET LOCK		8807FL - ENTRY LOCK	8808FL - CLASSROOM LOCK
AUR	626	021118	3
CRR	626	021119	4
MOR	626	021120	3
PBR	626	021121	3
8822FL - DORMITORY OR EXIT LOCK		8847FL - APARTMENT CORRIDOR DOOR LOCK	
AUR	626	021122	3
CRR	626	021123	4
MOR	626	021124	3
PBR	626	021125	3

Note: Yale reserves the right to limit quantities



Grade 1 Mortise Locks

8800FL SERIES: LOCK BODY WITH ARMOR FRONT AND STRIKE

MODEL#	FINISH	HAND	QUICKSHIP #	APPROX. WEIGHT (LBS. EACH)
8801FL - PASSAGE OR CLOSET LOCK				
8801FL	626	RH	000777	2
8802FL - PRIVACY, BEDROOM OR BATH LOCK				
8802FL	626	RH	000779	2
8805FL - STOREROOM OR CLOSET LOCK				
8805FL	626	RH	000781	2
8807FL - ENTRY LOCK				
8807FL	626	RH	000783	2
8808FL - CLASSROOM LOCK				
8808FL	626	RH	000785	2
8822FL - DORMITORY OR EXIT LOCK				
8822FL	626	RH	000787	2
8847FL - APARTMENT CORRIDOR DOOR LOCK				
8847FL	626	RH	000789	2

8800FL SERIES: ELECTRIFIED LOCK BODY WITH ARMOR FRONT AND STRIKE

MODEL #	FINISH	HAND	QUICKSHIP #	APPROX. WEIGHT (LBS. EACH)
8890FL - 24V FAIL SAFE				
8890FL	626	RH	009264	2
8890FL x REX	626	RH	009266	2
8891FL - 24V FAIL SECURE				
8891FL	626	RH	009268	2
8891FL x REX	626	RH	009270	2

Note: Yale reserves the right to limit quantities



Grade 1 Mortise Locks

MORTISE CYLINDERS AND ACCESSORIES

MODEL #	DESCRIPTION	KEY SECTION	FINISH	COLLAR SIZE INCLUDED	QUICKSHIP #	APPROX. WEIGHT (LBS. EACH)
MORTISE CYLINDERS						
2153 x 1-1/8"	6-Pin, Keyed Random	GA	626	1765.250	002789	0.4
2153 x 1-1/8"	6-Pin, 0-Bitted	GA	626	1765.250	002752	0.4
2153 x 1-1/8"	6-Pin, Keyed Random	PARA	626	1765.250	002694	0.4
2153 x 1-1/8"	6-Pin, 0-Bitted	PARA	626	1765.250	002796	0.4
2553 x 1-1/8"	6-Pin, Schlage® Keyed Random	C	626	1765.250	022000	0.4
2553 x 1-1/8"	6-Pin, Schlage® 0-Bitted	C	626	1765.250	022001	0.4
MORTISE CYLINDERS (LARGE FORMAT INTERCHANGEABLE CORE)						
2196 x 1-1/2"	LFIC, 6-Pin, 0-Bitted	GA	626	1765.656	022002	1
2196 x 1-1/2"	LFIC, 6-Pin, 0-Bitted	PARA	626	1765.656	022003	1
MORTISE HOUSINGS						
2221 x 1-1/2"	LFIC Housing Only, Less Core	—	626	1765.656	022004	0.4
K660 x 1-3/8"	SFIC Housing Only, Less Core	—	626	1765.563	022005	0.4
INTERCHANGEABLE CORES (LARGE FORMAT)						
1210	Core Only, 6-Pin, 0-Bitted	GA	626	—	001783	0.3
1210	Core Only, 6-Pin, 0-Bitted	PARA	626	—	001791	0.3
ARMOR FRONT & STRIKE PACKS						
—	For 8801/8862(FL)	—	630	—	000695	0.3
—	For 8802/8811/8822/ 8823/8861(FL)	—	630	—	000696	0.3
—	For 8805/8808/8809/ 8817/8824/8828/8829/ 8830/8833/8834/ 8834-2/8864/8865(FL)	—	630	—	000697	0.3
—	For 8807(FL)	—	630	—	000698	0.3
—	For 8827/8847(FL)	—	630	—	000699	0.3
POWER SUPPLY						
BPS-24-1	1 Amp Power Supply	—	—	—	003450	9
MISCELLANEOUS						
1160L	Optional Cam for Adams Rite® Narrow Stile Locks	—	—	—	002979	0.1
—	Cylinder Ring	—	626	1765.156	022071	0.1
—	Cylinder Ring	—	626	1765.219	022072	0.1
—	Cylinder Ring	—	626	1765.250	001611	0.1
—	Cylinder Ring	—	626	1765.656	001610	0.1
—	Cylinder Ring	—	626	KP4	001612	0.1

Note: Yale reserves the right to limit quantities



Grade 1 Cylindrical Lever Locks

5400LN SERIES: 2-3/4" BACKSET



Augusta - AU



Monroe - MO



Pacific Beach - PB

DESIGN	MODEL #	FINISH	STRIKE	CYLINDER	QUICKSHIP #	APPROX. WEIGHT (LBS. EACH)
5401LN - PASSAGE OR CLOSET LATCH						
AU	5401LN	626	497 ANSI	—	001987	4
MO	5401LN	626	497 ANSI	—	002007	4
PB	5401LN	626	497 ANSI	—	001997	4
5402LN - PRIVACY, BEDROOM OR BATH LOCK						
AU	5402LN	626	497 ANSI	—	001989	4
MO	5402LN	626	497 ANSI	—	002008	4
PB	5402LN	626	497 ANSI	—	001999	4
5404LN - ENTRY LOCK						
AU	5404LN	626	497 ANSI	Less Cylinder	002030	5
AU	5404LN	626	497 ANSI	1802, 6-Pin, GA Keyed Random	021150	5
AU	5404LN	626	497 ANSI	1802, 6-Pin, GA 0-Bitted	021151	5
AU	5404LN	626	497 ANSI	1802, 6-Pin, PARA Keyed Random	021152	5
AU	5404LN	626	497 ANSI	1802, 6-Pin, PARA 0-Bitted	021153	5
AU	5404LN	626	497 ANSI	2802, 6-Pin, Schlage® C Keyed Random	021154	5
AU	5404LN	626	497 ANSI	2802, 6-Pin, Schlage® C 0-Bitted	021155	5
MO	5404LN	626	497 ANSI	Less Cylinder	021156	5
MO	5404LN	626	497 ANSI	1802, 6-Pin, GA Keyed Random	021157	5
MO	5404LN	626	497 ANSI	1802, 6-Pin, GA 0-Bitted	021158	5
MO	5404LN	626	497 ANSI	1802, 6-Pin, PARA Keyed Random	021159	5
MO	5404LN	626	497 ANSI	1802, 6-Pin, PARA 0-Bitted	021160	5
MO	5404LN	626	497 ANSI	2802, 6-Pin, Schlage® C Keyed Random	021161	5
MO	5404LN	626	497 ANSI	2802, 6-Pin, Schlage® C 0-Bitted	021162	5
PB	5404LN	626	497 ANSI	Less Cylinder	002031	5
PB	5404LN	626	497 ANSI	1802, 6-Pin, GA Keyed Random	021163	5
PB	5404LN	626	497 ANSI	1802, 6-Pin, GA 0-Bitted	021164	5
PB	5404LN	626	497 ANSI	1802, 6-Pin, PARA Keyed Random	021165	5
PB	5404LN	626	497 ANSI	1802, 6-Pin, PARA 0-Bitted	021166	5
PB	5404LN	626	497 ANSI	2802, 6-Pin, Schlage® C Keyed Random	021167	5
PB	5404LN	626	497 ANSI	2802, 6-Pin, Schlage® C 0-Bitted	021168	5
5404LN - ENTRY LOCK (YALE INTERCHANGEABLE CORE)						
AU	5404LN	626	497 ANSI	Less Core	021169	5
5404LN - ENTRY LOCK (SMALL FORMAT INTERCHANGEABLE CORE)						
BAU	5404LN	626	497 ANSI	Less Core	021170	5

Note: Yale reserves the right to limit quantities



Grade 1 Cylindrical Lever Locks

5400LN SERIES: 2-3/4" BACKSET



Augusta - AU



Monroe - MO



Pacific Beach - PB

DESIGN	MODEL #	FINISH	STRIKE	CYLINDER	QUICKSHIP #	APPROX. WEIGHT (LBS. EACH)
5405LN - STOREROOM OR CLOSET LOCK						
AU	5405LN	626	497 ANSI	Less Cylinder	001420	5
AU	5405LN	626	497 ANSI	1802, 6-Pin, GA Keyed Random	014043	5
AU	5405LN	626	497 ANSI	1802, 6-Pin, GA 0-Bitted	014040	5
AU	5405LN	626	497 ANSI	1802, 6-Pin, PARA Keyed Random	014055	5
AU	5405LN	626	497 ANSI	1802, 6-Pin, PARA 0-Bitted	014052	5
AU	5405LN	626	497 ANSI	2802, 6-Pin, Schlage® C Keyed Random	014150	5
AU	5405LN	626	497 ANSI	2802, 6-Pin, Schlage® C 0-Bitted	014165	5
MO	5405LN	626	497 ANSI	Less Cylinder	001426	5
MO	5405LN	626	497 ANSI	1802, 6-Pin, GA Keyed Random	014133	5
MO	5405LN	626	497 ANSI	1802, 6-Pin, GA 0-Bitted	014130	5
MO	5405LN	626	497 ANSI	1802, 6-Pin, PARA Keyed Random	014145	5
MO	5405LN	626	497 ANSI	1802, 6-Pin, PARA 0-Bitted	014142	5
MO	5405LN	626	497 ANSI	2802, 6-Pin, Schlage® C Keyed Random	014162	5
MO	5405LN	626	497 ANSI	2802, 6-Pin, Schlage® C 0-Bitted	014177	5
PB	5405LN	626	497 ANSI	Less Cylinder	001423	5
PB	5405LN	626	497 ANSI	1802, 6-Pin, GA Keyed Random	014088	5
PB	5405LN	626	497 ANSI	1802, 6-Pin, GA 0-Bitted	014085	5
PB	5405LN	626	497 ANSI	1802, 6-Pin, PARA Keyed Random	014100	5
PB	5405LN	626	497 ANSI	1802, 6-Pin, PARA 0-Bitted	014097	5
PB	5405LN	626	497 ANSI	2802, 6-Pin, Schlage® C Keyed Random	014156	5
PB	5405LN	626	497 ANSI	2802, 6-Pin, Schlage® C 0-Bitted	014171	5
5405LN - STOREROOM OR CLOSET LOCK (YALE INTERCHANGEABLE CORE)						
AU	5405LN	626	497 ANSI	Less Core	001983	5
5405LN - STOREROOM OR CLOSET LOCK (SMALL FORMAT INTERCHANGEABLE CORE)						
BAU	5405LN	626	497 ANSI	Less Core	001980	5
5407LN - ENTRY LOCK						
AU	5407LN	626	497 ANSI	Less Cylinder	001421	5
AU	5407LN	626	497 ANSI	1802, 6-Pin, GA Keyed Random	014044	5
AU	5407LN	626	497 ANSI	1802, 6-Pin, GA 0-Bitted	014041	5
AU	5407LN	626	497 ANSI	1802, 6-Pin, PARA Keyed Random	014056	5
AU	5407LN	626	497 ANSI	1802, 6-Pin, PARA 0-Bitted	014053	5

Note: Yale reserves the right to limit quantities



Grade 1 Cylindrical Lever Locks

5400LN SERIES: 2-3/4" BACKSET



Augusta - AU



Monroe - MO



Pacific Beach - PB

DESIGN	MODEL #	FINISH	STRIKE	CYLINDER	QUICKSHIP #	APPROX. WEIGHT (LBS. EACH)
AU	5407LN	626	497 ANSI	2802, 6-Pin, Schlage® C Keyed Random	014151	5
AU	5407LN	626	497 ANSI	2802, 6-Pin, Schlage® C 0-Bitted	014166	5
MO	5407LN	626	497 ANSI	Less Cylinder	001427	5
MO	5407LN	626	497 ANSI	1802, 6-Pin, GA Keyed Random	014134	5
MO	5407LN	626	497 ANSI	1802, 6-Pin, GA 0-Bitted	014131	5
MO	5407LN	626	497 ANSI	1802, 6-Pin, PARA Keyed Random	014146	5
MO	5407LN	626	497 ANSI	1802, 6-Pin, PARA 0-Bitted	014143	5
MO	5407LN	626	497 ANSI	2802, 6-Pin, Schlage® C Keyed Random	014163	5
MO	5407LN	626	497 ANSI	2802, 6-Pin, Schlage® C 0-Bitted	014178	5
PB	5407LN	626	497 ANSI	Less Cylinder	001424	5
PB	5407LN	626	497 ANSI	1802, 6-Pin, GA Keyed Random	014089	5
PB	5407LN	626	497 ANSI	1802, 6-Pin, GA 0-Bitted	014086	5
PB	5407LN	626	497 ANSI	1802, 6-Pin, PARA Keyed Random	014101	5
PB	5407LN	626	497 ANSI	1802, 6-Pin, PARA 0-Bitted	014098	5
PB	5407LN	626	497 ANSI	2802, 6-Pin, Schlage® C Keyed Random	014157	5
PB	5407LN	626	497 ANSI	2802, 6-Pin, Schlage® C 0-Bitted	014172	5
5407LN - ENTRY LOCK (YALE INTERCHANGEABLE CORE)						
AU	5407LN	626	497 ANSI	Less Core	001984	5
5407LN - ENTRY LOCK (SMALL FORMAT INTERCHANGEABLE CORE)						
BAU	5407LN	626	497 ANSI	Less Core	001981	5
5408LN - CLASSROOM LOCK						
AU	5408LN	626	497 ANSI	Less Cylinder	001422	5
AU	5408LN	626	497 ANSI	1802, 6-Pin, GA Keyed Random	014045	5
AU	5408LN	626	497 ANSI	1802, 6-Pin, GA 0-Bitted	014042	5
AU	5408LN	626	497 ANSI	1802, 6-Pin, PARA Keyed Random	014057	5
AU	5408LN	626	497 ANSI	1802, 6-Pin, PARA 0-Bitted	014054	5
AU	5408LN	626	497 ANSI	2802, 6-Pin, Schlage® C Keyed Random	014152	5
AU	5408LN	626	497 ANSI	2802, 6-Pin, Schlage® C 0-Bitted	014167	5
MO	5408LN	626	497 ANSI	Less Cylinder	001428	5
MO	5408LN	626	497 ANSI	1802, 6-Pin, GA Keyed Random	014135	5
MO	5408LN	626	497 ANSI	1802, 6-Pin, GA 0-Bitted	014132	5
MO	5408LN	626	497 ANSI	1802, 6-Pin, PARA Keyed Random	014147	5

Note: Yale reserves the right to limit quantities



Grade 1 Cylindrical Lever Locks

5400LN SERIES: 2-3/4" BACKSET



Augusta - AU



Monroe - MO



Pacific Beach - PB

DESIGN	MODEL #	FINISH	STRIKE	CYLINDER	QUICKSHIP #	APPROX. WEIGHT (LBS. EACH)
MO	5408LN	626	497 ANSI	1802, 6-Pin, PARA 0-Bitted	014144	5
MO	5408LN	626	497 ANSI	2802, 6-Pin, Schlage® C Keyed Random	014164	5
MO	5408LN	626	497 ANSI	2802, 6-Pin, Schlage® C 0-Bitted	014173	5
PB	5408LN	626	497 ANSI	Less Cylinder	001425	5
PB	5408LN	626	497 ANSI	1802, 6-Pin, GA Keyed Random	014090	5
PB	5408LN	626	497 ANSI	1802, 6-Pin, GA 0-Bitted	014087	5
PB	5408LN	626	497 ANSI	1802, 6-Pin, PARA Keyed Random	014102	5
PB	5408LN	626	497 ANSI	1802, 6-Pin, PARA 0-Bitted	014099	5
PB	5408LN	626	497 ANSI	2802, 6-Pin, Schlage® C Keyed Random	014158	5
PB	5408LN	626	497 ANSI	2802, 6-Pin, Schlage® C 0-Bitted	014179	5
5408LN - CLASSROOM LOCK (YALE INTERCHANGEABLE CORE)						
AU	5408LN	626	497 ANSI	Less Core	001985	5
5408LN - CLASSROOM LOCK (SMALL FORMAT INTERCHANGEABLE CORE)						
BAU	5408LN	626	497 ANSI	Less Core	001982	5
455LN - DUMMY TRIM						
AU	455LN	626	—	—	001308	2
MO	455LN	626	—	—	021171	2
PB	455LN	626	—	—	021172	2

Note: Yale reserves the right to limit quantities



Grade 1 Cylindrical Lever Locks

5400LN ELECTRIFIED SERIES: 2-3/4" BACKSET



Augusta - AU

DESIGN	MODEL #	FINISH	STRIKE	CYLINDER	QUICKSHIP #	APPROX. WEIGHT (LBS. EACH)
5490LN - 24V FAIL SAFE						
AU	5490LN	626	497 ANSI	Less Cylinder	001409	5
AU	5490LN	626	497 ANSI	1802, 6-Pin, GA Keyed Random	021173	5
AU	5490LN	626	497 ANSI	1802, 6-Pin, GA 0-Bitted	021174	5
AU	5490LN	626	497 ANSI	1802, 6-Pin, PARA Keyed Random	021175	5
AU	5490LN	626	497 ANSI	1802, 6-Pin, PARA 0-Bitted	021176	5
AU	5490LN	626	497 ANSI	2802, 6-Pin, Schlage® C Keyed Random	021177	5
AU	5490LN	626	497 ANSI	2802, 6-Pin, Schlage® C 0-Bitted	021178	5
5491LN - 24V FAIL SECURE						
AU	5491LN	626	497 ANSI	Less Cylinder	001410	5
AU	5491LN	626	497 ANSI	1802, 6-Pin, GA Keyed Random	021179	5
AU	5491LN	626	497 ANSI	1802, 6-Pin, GA 0-Bitted	021180	5
AU	5491LN	626	497 ANSI	1802, 6-Pin, PARA Keyed Random	021181	5
AU	5491LN	626	497 ANSI	1802, 6-Pin, PARA 0-Bitted	021182	5
AU	5491LN	626	497 ANSI	2802, 6-Pin, Schlage® C Keyed Random	021183	5
AU	5491LN	626	497 ANSI	2802, 6-Pin, Schlage® C 0-Bitted	021184	5

Note: Yale reserves the right to limit quantities



Grade 1 Cylindrical Lever Locks

4700LN SERIES: 2-3/4" BACKSET



Augusta - AU



Monroe - MO



Pacific Beach - PB

DESIGN	MODEL #	FINISH	STRIKE	CYLINDER	QUICKSHIP #	APPROX. WEIGHT (LBS. EACH)
4701LN - PASSAGE OR CLOSET LATCH						
AU	4701LN	626	497 ANSI	—	017000	4
MO	4701LN	626	497 ANSI	—	017008	4
PB	4701LN	626	497 ANSI	—	017016	4
4702LN - PRIVACY, BEDROOM OR BATH LOCK						
AU	4702LN	626	497 ANSI	—	017001	4
MO	4702LN	626	497 ANSI	—	017009	4
PB	4702LN	626	497 ANSI	—	017017	4
4704LN - ENTRY LOCK						
AU	4704LN	626	497 ANSI	Less Cylinder	021185	5
AU	4704LN	626	497 ANSI	1804, 6-Pin, GA Keyed Random	021186	5
AU	4704LN	626	497 ANSI	1804, 6-Pin, GA 0-Bitted	021187	5
AU	4704LN	626	497 ANSI	1804, 6-Pin, PARA Keyed Random	017002	5
AU	4704LN	626	497 ANSI	1804, 6-Pin PARA 0-Bitted	017036	5
AU	4704LN	626	497 ANSI	2804, 6-Pin, Schlage® C Keyed Random	017024	5
AU	4704LN	626	497 ANSI	2804, 6-Pin, Schlage® C 0-Bitted	017048	5
MO	4704LN	626	497 ANSI	Less Cylinder	021188	5
MO	4704LN	626	497 ANSI	1804, 6-Pin, GA Keyed Random	021189	5
MO	4704LN	626	497 ANSI	1804, 6-Pin, GA 0-Bitted	021190	5
MO	4704LN	626	497 ANSI	1804, 6-Pin, PARA Keyed Random	017010	5
MO	4704LN	626	497 ANSI	1804, 6-Pin, PARA 0-Bitted	017044	5
MO	4704LN	626	497 ANSI	2804, 6-Pin, Schlage® C Keyed Random	017032	5
MO	4704LN	626	497 ANSI	2804, 6-Pin, Schlage® C 0-Bitted	017056	5
PB	4704LN	626	497 ANSI	Less Cylinder	021191	5
PB	4704LN	626	497 ANSI	1804, 6-Pin, GA Keyed Random	021192	5
PB	4704LN	626	497 ANSI	1804, 6-Pin, GA 0-Bitted	021193	5
PB	4704LN	626	497 ANSI	1804, 6-Pin, PARA Keyed Random	017018	5
PB	4704LN	626	497 ANSI	1804, 6-Pin PARA 0-Bitted	017040	5
PB	4704LN	626	497 ANSI	2804, 6-Pin, Schlage® C Keyed Random	017028	5
PB	4704LN	626	497 ANSI	2804, 6-Pin, Schlage® C 0-Bitted	017052	5

Note: Yale reserves the right to limit quantities



Grade 1 Cylindrical Lever Locks

4700LN SERIES: 2-3/4" BACKSET



Augusta - AU



Monroe - MO



Pacific Beach - PB

DESIGN	MODEL #	FINISH	STRIKE	CYLINDER	QUICKSHIP #	APPROX. WEIGHT (LBS. EACH)
4704LN - ENTRY LOCK (SMALL FORMAT INTERCHANGEABLE CORE)						
BAU	4704LN	626	497 ANSI	Less Core	017705	5
4705LN - STOREROOM OR CLOSET LOCK						
AU	4705LN	626	497 ANSI	Less Cylinder	021194	5
AU	4705LN	626	497 ANSI	1804, 6-Pin, GA Keyed Random	021195	5
AU	4705LN	626	497 ANSI	1804, 6-Pin, GA 0-Bitted	021196	5
AU	4705LN	626	497 ANSI	1804, 6-Pin, PARA Keyed Random	017003	5
AU	4705LN	626	497 ANSI	1804, 6-Pin PARA 0-Bitted	017037	5
AU	4705LN	626	497 ANSI	2804, 6-Pin, Schlage® C Keyed Random	017025	5
AU	4705LN	626	497 ANSI	2804, 6-Pin, Schlage® C 0-Bitted	017049	5
MO	4705LN	626	497 ANSI	Less Cylinder	021197	5
MO	4705LN	626	497 ANSI	1804, 6-Pin, GA Keyed Random	021198	5
MO	4705LN	626	497 ANSI	1804, 6-Pin, GA 0-Bitted	021199	5
MO	4705LN	626	497 ANSI	1804, 6-Pin, PARA Keyed Random	017011	5
MO	4705LN	626	497 ANSI	1804, 6-Pin, PARA 0-Bitted	017045	5
MO	4705LN	626	497 ANSI	2804, 6-Pin, Schlage® C Keyed Random	017033	5
MO	4705LN	626	497 ANSI	2804, 6-Pin, Schlage® C 0-Bitted	017057	5
PB	4705LN	626	497 ANSI	Less Cylinder	021200	5
PB	4705LN	626	497 ANSI	1804, 6-Pin, GA Keyed Random	021201	5
PB	4705LN	626	497 ANSI	1804, 6-Pin, GA 0-Bitted	021202	5
PB	4705LN	626	497 ANSI	1804, 6-Pin, PARA Keyed Random	017019	5
PB	4705LN	626	497 ANSI	1804, 6-Pin PARA 0-Bitted	017041	5
PB	4705LN	626	497 ANSI	2804, 6-Pin, Schlage® C Keyed Random	017029	5
PB	4705LN	626	497 ANSI	2804, 6-Pin, Schlage® C 0-Bitted	017053	5
4705LN - STOREROOM OR CLOSET LOCK (SMALL FORMAT INTERCHANGEABLE CORE)						
BAU	4705LN	626	497 ANSI	Less Core	017706	5
4707LN - ENTRY LOCK						
AU	4707LN	626	497 ANSI	Less Cylinder	021203	5
AU	4707LN	626	497 ANSI	1804, 6-Pin, GA Keyed Random	021204	5
AU	4707LN	626	497 ANSI	1804, 6-Pin, GA 0-Bitted	021205	5
AU	4707LN	626	497 ANSI	1804, 6-Pin, PARA Keyed Random	017004	5

Note: Yale reserves the right to limit quantities



Grade 1 Cylindrical Lever Locks

4700LN SERIES: 2-3/4" BACKSET



Augusta - AU



Monroe - MO



Pacific Beach - PB

DESIGN	MODEL #	FINISH	STRIKE	CYLINDER	QUICKSHIP #	APPROX. WEIGHT (LBS. EACH)
AU	4707LN	626	497 ANSI	1804, 6-Pin PARA 0-Bitted	017038	5
AU	4707LN	626	497 ANSI	2804, 6-Pin, Schlage® C Keyed Random	017026	5
AU	4707LN	626	497 ANSI	2804, 6-Pin, Schlage® C 0-Bitted	017050	5
MO	4707LN	626	497 ANSI	Less Cylinder	021206	5
MO	4707LN	626	497 ANSI	1804, 6-Pin, GA Keyed Random	021207	5
MO	4707LN	626	497 ANSI	1804, 6-Pin, GA 0-Bitted	021208	5
MO	4707LN	626	497 ANSI	1804, 6-Pin, PARA Keyed Random	017012	5
MO	4707LN	626	497 ANSI	1804, 6-Pin PARA 0-Bitted	017046	5
MO	4707LN	626	497 ANSI	2804, 6-Pin, Schlage® C Keyed Random	017034	5
MO	4707LN	626	497 ANSI	2804, 6-Pin, Schlage® C 0-Bitted	017058	5
PB	4707LN	626	497 ANSI	Less Cylinder	021209	5
PB	4707LN	626	497 ANSI	1804, 6-Pin, GA Keyed Random	021210	5
PB	4707LN	626	497 ANSI	1804, 6-Pin, GA 0-Bitted	021211	5
PB	4707LN	626	497 ANSI	1804, 6-Pin, PARA Keyed Random	017020	5
PB	4707LN	626	497 ANSI	1804, 6-Pin PARA 0-Bitted	017042	5
PB	4707LN	626	497 ANSI	2804, 6-Pin, Schlage® C Keyed Random	017030	5
PB	4707LN	626	497 ANSI	2804, 6-Pin, Schlage® C 0-Bitted	017054	5
4707LN - ENTRY LOCK (SMALL FORMAT INTERCHANGEABLE CORE)						
BAU	4707LN	626	497 ANSI	Less Core	017707	5
4708LN - CLASSROOM LOCK						
AU	4708LN	626	497 ANSI	Less Cylinder	021212	5
AU	4708LN	626	497 ANSI	1804, 6-Pin, GA Keyed Random	021213	5
AU	4708LN	626	497 ANSI	1804, 6-Pin, GA 0-Bitted	021214	5
AU	4708LN	626	497 ANSI	1804, 6-Pin, PARA Keyed Random	017005	5
AU	4708LN	626	497 ANSI	1804, 6-Pin PARA 0-Bitted	017039	5
AU	4708LN	626	497 ANSI	2804, 6-Pin, Schlage® C Keyed Random	017027	5
AU	4708LN	626	497 ANSI	2804, 6-Pin, Schlage® C 0-Bitted	017051	5
MO	4708LN	626	497 ANSI	Less Cylinder	021215	5
MO	4708LN	626	497 ANSI	1804, 6-Pin, GA Keyed Random	021216	5
MO	4708LN	626	497 ANSI	1804, 6-Pin, GA 0-Bitted	021217	5
MO	4708LN	626	497 ANSI	1804, 6-Pin, PARA Keyed Random	017013	5

Note: Yale reserves the right to limit quantities



Grade 1 Cylindrical Lever Locks

4700LN SERIES: 2-3/4" BACKSET



Augusta - AU



Monroe - MO



Pacific Beach - PB

DESIGN	MODEL #	FINISH	STRIKE	CYLINDER	QUICKSHIP #	APPROX. WEIGHT (LBS. EACH)
MO	4708LN	626	497 ANSI	1804, 6-Pin PARA 0-Bitted	017047	5
MO	4708LN	626	497 ANSI	2804, 6-Pin, Schlage® C Keyed Random	017035	5
MO	4708LN	626	497 ANSI	2804, 6-Pin, Schlage® C 0-Bitted	017059	5
PB	4708LN	626	497 ANSI	Less Cylinder	021218	5
PB	4708LN	626	497 ANSI	1804, 6-Pin, GA Keyed Random	021219	5
PB	4708LN	626	497 ANSI	1804, 6-Pin, GA 0-Bitted	021220	5
PB	4708LN	626	497 ANSI	1804, 6-Pin, PARA Keyed Random	017021	5
PB	4708LN	626	497 ANSI	1804, 6-Pin PARA 0-Bitted	017043	5
PB	4708LN	626	497 ANSI	2804, 6-Pin, Schlage® C Keyed Random	017031	5
PB	4708LN	626	497 ANSI	2804, 6-Pin, Schlage® C 0-Bitted	017055	5
4708LN - CLASSROOM LOCK (SMALL FORMAT INTERCHANGEABLE CORE)						
BAU	4708LN	626	497 ANSI	Less Core	017708	5
4755LN - DUMMY TRIM						
AU	4755LN	626	—	—	017007	2
MO	4755LN	626	—	—	017015	2
PB	4755LN	626	—	—	017023	2

Note: Yale reserves the right to limit quantities



Grade 2 Cylindrical Lever Locks

5300LN SERIES: 2-3/4" BACKSET



Augusta - AU



Monroe - MO



Pacific Beach - PB

DESIGN	MODEL #	FINISH	STRIKE	CYLINDER	QUICKSHIP #	APPROX. WEIGHT (LBS. EACH)
5301LN - PASSAGE OR CLOSET LATCH						
AU	5301LN	626	497 ANSI	—	001390	4
MO	5301LN	626	497 ANSI	—	021221	4
PB	5301LN	626	497 ANSI	—	001456	4
5302LN - PRIVACY, BEDROOM OR BATH LOCK						
AU	5302LN	626	497 ANSI	—	001391	4
MO	5302LN	626	497 ANSI	—	021222	4
PB	5302LN	626	497 ANSI	—	001457	4
5304LN - ENTRY LOCK						
AU	5304LN	626	497 ANSI	Less Cylinder	021223	5
AU	5304LN	626	497 ANSI	1802, 6-Pin, GA Keyed Random	021224	5
AU	5304LN	626	497 ANSI	1802, 6-Pin, GA 0-Bitted	021225	5
AU	5304LN	626	497 ANSI	1802, 6-Pin, PARA Keyed Random	021226	5
AU	5304LN	626	497 ANSI	1802, 6-Pin, PARA 0-Bitted	021227	5
AU	5304LN	626	497 ANSI	2802, 6-Pin, Schlage® C Keyed Random	021228	5
AU	5304LN	626	497 ANSI	2802, 6-Pin, Schlage® C 0-Bitted	021229	5
MO	5304LN	626	497 ANSI	Less Cylinder	021230	5
MO	5304LN	626	497 ANSI	1802, 6-Pin, GA Keyed Random	021231	5
MO	5304LN	626	497 ANSI	1802, 6-Pin, GA 0-Bitted	021232	5
MO	5304LN	626	497 ANSI	1802, 6-Pin, PARA Keyed Random	021233	5
MO	5304LN	626	497 ANSI	1802, 6-Pin, PARA 0-Bitted	021234	5
MO	5304LN	626	497 ANSI	2802, 6-Pin, Schlage® C Keyed Random	021235	5
MO	5304LN	626	497 ANSI	2802, 6-Pin, Schlage® C 0-Bitted	021236	5
PB	5304LN	626	497 ANSI	Less Cylinder	021237	5
PB	5304LN	626	497 ANSI	1802, 6-Pin, GA Keyed Random	021238	5
PB	5304LN	626	497 ANSI	1802, 6-Pin, GA 0-Bitted	021239	5
PB	5304LN	626	497 ANSI	1802, 6-Pin, PARA Keyed Random	021240	5
PB	5304LN	626	497 ANSI	1802, 6-Pin, PARA 0-Bitted	021241	5
PB	5304LN	626	497 ANSI	2802, 6-Pin, Schlage® C Keyed Random	021242	5
PB	5304LN	626	497 ANSI	2802, 6-Pin, Schlage® C 0-Bitted	021243	5

Note: Yale reserves the right to limit quantities



Grade 2 Cylindrical Lever Locks

5300LN SERIES: 2-3/4" BACKSET



Augusta - AU



Monroe - MO



Pacific Beach - PB

DESIGN	MODEL #	FINISH	STRIKE	CYLINDER	QUICKSHIP #	APPROX. WEIGHT (LBS. EACH)
5304LN - ENTRY LOCK (YALE INTERCHANGEABLE CORE)						
AU	5304LN	626	497 ANSI	Less Core	021244	5
5304LN - ENTRY LOCK (SMALL FORMAT INTERCHANGEABLE CORE)						
BAU	5304LN	626	497 ANSI	Less Core	021245	5
5305LN - STOREROOM OR CLOSET LOCK						
AU	5305LN	626	497 ANSI	Less Cylinder	001392	5
AU	5305LN	626	497 ANSI	1802, 6-Pin, GA Keyed Random	002236	5
AU	5305LN	626	497 ANSI	1802, 6-Pin, GA 0-Bitted	011768	5
AU	5305LN	626	497 ANSI	1802, 6-Pin, PARA Keyed Random	002233	5
AU	5305LN	626	497 ANSI	1802, 6-Pin, PARA 0-Bitted	011756	5
AU	5305LN	626	497 ANSI	2802, 6-Pin, Schlage® C Keyed Random	010303	5
AU	5305LN	626	497 ANSI	2802, 6-Pin, Schlage® C 0-Bitted	010127	5
MO	5305LN	626	497 ANSI	Less Cylinder	021246	5
MO	5305LN	626	497 ANSI	1802, 6-Pin, GA Keyed Random	021247	5
MO	5305LN	626	497 ANSI	1802, 6-Pin, GA 0-Bitted	021248	5
MO	5305LN	626	497 ANSI	1802, 6-Pin, PARA Keyed Random	021249	5
MO	5305LN	626	497 ANSI	1802, 6-Pin, PARA 0-Bitted	021250	5
MO	5305LN	626	497 ANSI	2802, 6-Pin, Schlage® C Keyed Random	021251	5
MO	5305LN	626	497 ANSI	2802, 6-Pin, Schlage® C 0-Bitted	021252	5
PB	5305LN	626	497 ANSI	Less Cylinder	001458	5
PB	5305LN	626	497 ANSI	1802, 6-Pin, GA Keyed Random	021253	5
PB	5305LN	626	497 ANSI	1802, 6-Pin, GA 0-Bitted	021254	5
PB	5305LN	626	497 ANSI	1802, 6-Pin, PARA Keyed Random	021255	5
PB	5305LN	626	497 ANSI	1802, 6-Pin, PARA 0-Bitted	021256	5
PB	5305LN	626	497 ANSI	2802, 6-Pin, Schlage® C Keyed Random	021257	5
PB	5305LN	626	497 ANSI	2802, 6-Pin, Schlage® C 0-Bitted	021258	5
5305LN - STOREROOM OR CLOSET LOCK (YALE INTERCHANGEABLE CORE)						
AU	5305LN	626	497 ANSI	Less Core	001321	5
5305LN - STOREROOM OR CLOSET LOCK (SMALL FORMAT INTERCHANGEABLE CORE)						
BAU	5305LN	626	497 ANSI	Less Core	001342	5

Note: Yale reserves the right to limit quantities



Grade 2 Cylindrical Lever Locks

5300LN SERIES: 2-3/4" BACKSET



Augusta - AU



Monroe - MO



Pacific Beach - PB

DESIGN	MODEL #	FINISH	STRIKE	CYLINDER	QUICKSHIP #	APPROX. WEIGHT (LBS. EACH)
5307LN - ENTRY LOCK						
AU	5307LN	626	497 ANSI	Less Cylinder	001393	5
AU	5307LN	626	497 ANSI	1802, 6-Pin, GA Keyed Random	002237	5
AU	5307LN	626	497 ANSI	1802, 6-Pin, GA 0-Bitted	011769	5
AU	5307LN	626	497 ANSI	1802, 6-Pin, PARA Keyed Random	002234	5
AU	5307LN	626	497 ANSI	1802, 6-Pin, PARA 0-Bitted	011757	5
AU	5307LN	626	497 ANSI	2802, 6-Pin, Schlage® C Keyed Random	010304	5
AU	5307LN	626	497 ANSI	2802, 6-Pin, Schlage® C 0-Bitted	010128	5
MO	5307LN	626	497 ANSI	Less Cylinder	021259	5
MO	5307LN	626	497 ANSI	1802, 6-Pin, GA Keyed Random	021260	5
MO	5307LN	626	497 ANSI	1802, 6-Pin, GA 0-Bitted	021261	5
MO	5307LN	626	497 ANSI	1802, 6-Pin, PARA Keyed Random	021262	5
MO	5307LN	626	497 ANSI	1802, 6-Pin, PARA 0-Bitted	021263	5
MO	5307LN	626	497 ANSI	2802, 6-Pin, Schlage® C Keyed Random	021264	5
MO	5307LN	626	497 ANSI	2802, 6-Pin, Schlage® C 0-Bitted	021265	5
PB	5307LN	626	497 ANSI	Less Cylinder	001459	5
PB	5307LN	626	497 ANSI	1802, 6-Pin, GA Keyed Random	021266	5
PB	5307LN	626	497 ANSI	1802, 6-Pin, GA 0-Bitted	021267	5
PB	5307LN	626	497 ANSI	1802, 6-Pin, PARA Keyed Random	021268	5
PB	5307LN	626	497 ANSI	1802, 6-Pin, PARA 0-Bitted	021269	5
PB	5307LN	626	497 ANSI	2802, 6-Pin, Schlage® C Keyed Random	021270	5
PB	5307LN	626	497 ANSI	2802, 6-Pin, Schlage® C 0-Bitted	021271	5
5307LN - ENTRY LOCK (YALE INTERCHANGEABLE CORE)						
AU	5307LN	626	497 ANSI	Less Core	001322	5
5307LN - ENTRY LOCK (SMALL FORMAT INTERCHANGEABLE CORE)						
BAU	5307LN	626	497 ANSI	Less Core	001343	5

Note: Yale reserves the right to limit quantities



Grade 2 Cylindrical Lever Locks

5300LN SERIES: 2-3/4" BACKSET



Augusta - AU



Monroe - MO



Pacific Beach - PB

DESIGN	MODEL #	FINISH	STRIKE	CYLINDER	QUICKSHIP #	APPROX. WEIGHT (LBS. EACH)
5308LN - CLASSROOM LOCK						
AU	5308LN	626	497 ANSI	Less Cylinder	001394	5
AU	5308LN	626	497 ANSI	1802, 6-Pin, GA Keyed Random	002238	5
AU	5308LN	626	497 ANSI	1802, 6-Pin, GA 0-Bitted	011770	5
AU	5308LN	626	497 ANSI	1802, 6-Pin, PARA Keyed Random	002235	5
AU	5308LN	626	497 ANSI	1802, 6-Pin, PARA 0-Bitted	011758	5
AU	5308LN	626	497 ANSI	2802, 6-Pin, Schlage® C Keyed Random	010129	5
AU	5308LN	626	497 ANSI	2802, 6-Pin, Schlage® C 0-Bitted	010305	5
MO	5308LN	626	497 ANSI	Less Cylinder	021272	5
MO	5308LN	626	497 ANSI	1802, 6-Pin, GA Keyed Random	021273	5
MO	5308LN	626	497 ANSI	1802, 6-Pin, GA 0-Bitted	021274	5
MO	5308LN	626	497 ANSI	1802, 6-Pin, PARA Keyed Random	021275	5
MO	5308LN	626	497 ANSI	1802, 6-Pin, PARA 0-Bitted	021276	5
MO	5308LN	626	497 ANSI	2802, 6-Pin, Schlage® C Keyed Random	021277	5
MO	5308LN	626	497 ANSI	2802, 6-Pin, Schlage® C 0-Bitted	021278	5
PB	5308LN	626	497 ANSI	Less Cylinder	001460	5
PB	5308LN	626	497 ANSI	1802, 6-Pin, GA Keyed Random	021279	5
PB	5308LN	626	497 ANSI	1802, 6-Pin, GA 0-Bitted	021280	5
PB	5308LN	626	497 ANSI	1802, 6-Pin, PARA Keyed Random	021281	5
PB	5308LN	626	497 ANSI	1802, 6-Pin, PARA 0-Bitted	021282	5
PB	5308LN	626	497 ANSI	2802, 6-Pin, Schlage® C Keyed Random	021283	5
PB	5308LN	626	497 ANSI	2802, 6-Pin, Schlage® C 0-Bitted	021284	5
5308LN - CLASSROOM LOCK (YALE INTERCHANGEABLE CORE)						
AU	5308LN	626	497 ANSI	Less Core	001323	5
5308LN - CLASSROOM LOCK (SMALL FORMAT INTERCHANGEABLE CORE)						
BAU	5308LN	626	497 ANSI	Less Core	001344	5
355LN - DUMMY TRIM						
AU	355LN	626	—	—	001201	2
MO	355LN	626	—	—	021285	2
PB	355LN	626	—	—	001461	2

Note: Yale reserves the right to limit quantities



Grade 2 Cylindrical Lever Locks

5300LN ELECTRIFIED SERIES: 2-3/4" BACKSET



Augusta - AU

DESIGN	MODEL #	FINISH	STRIKE	CYLINDER	QUICKSHIP #	APPROX. WEIGHT (LBS. EACH)
5390LN - 24V FAIL SAFE						
AU	5390LN	626	497 ANSI	Less Cylinder	021286	5
AU	5390LN	626	497 ANSI	1802, 6-Pin, GA Keyed Random	021287	5
AU	5390LN	626	497 ANSI	1802, 6-Pin, GA 0-Bitted	021288	5
AU	5390LN	626	497 ANSI	1802, 6-Pin, PARA Keyed Random	021289	5
AU	5390LN	626	497 ANSI	1802, 6-Pin, PARA 0-Bitted	021290	5
AU	5390LN	626	497 ANSI	2802, 6-Pin, Schlage® C Keyed Random	021291	5
AU	5390LN	626	497 ANSI	2802, 6-Pin, Schlage® C 0-Bitted	021292	5
5391LN - 24V FAIL SECURE						
AU	5391LN	626	497 ANSI	Less Cylinder	021293	5
AU	5391LN	626	497 ANSI	1802, 6-Pin, GA Keyed Random	021294	5
AU	5391LN	626	497 ANSI	1802, 6-Pin, GA 0-Bitted	021295	5
AU	5391LN	626	497 ANSI	1802, 6-Pin, PARA Keyed Random	021296	5
AU	5391LN	626	497 ANSI	1802, 6-Pin, PARA 0-Bitted	021297	5
AU	5391LN	626	497 ANSI	2802, 6-Pin, Schlage® C Keyed Random	021298	5
AU	5391LN	626	497 ANSI	2802, 6-Pin, Schlage® C 0-Bitted	021299	5

Note: Yale reserves the right to limit quantities



Grade 2 Cylindrical Lever Locks

4600LN SERIES: 2-3/4" BACKSET



Augusta - AU



Monroe - MO



Pacific Beach - PB

DESIGN	MODEL #	FINISH	STRIKE	CYLINDER	QUICKSHIP #	APPROX. WEIGHT (LBS. EACH)
4601LN - PASSAGE OR CLOSET LATCH						
AU	4601LN	613E	497 ANSI	—	017177	4
AU	4601LN	626	497 ANSI	—	017129	4
MO	4601LN	626	497 ANSI	—	021300	4
PB	4601LN	613E	497 ANSI	—	017184	4
PB	4601LN	626	497 ANSI	—	017136	4
4602LN - PRIVACY, BEDROOM OR BATH LOCK						
AU	4602LN	613E	497 ANSI	—	017178	4
AU	4602LN	626	497 ANSI	—	017130	4
MO	4602LN	626	497 ANSI	—	021301	4
PB	4602LN	613E	497 ANSI	—	017185	4
PB	4602LN	626	497 ANSI	—	017137	4
4604LN - ENTRY LOCK						
AU	4604LN	613E	497 ANSI	Less Cylinder	021302	5
AU	4604LN	613E	497 ANSI	1806, 6-Pin, GA Keyed Random	021303	5
AU	4604LN	613E	497 ANSI	1806, 6-Pin, GA 0-Bitted	021304	5
AU	4604LN	613E	497 ANSI	1806, 6-Pin, PARA Keyed Random	021305	5
AU	4604LN	613E	497 ANSI	1806, 6-Pin PARA 0-Bitted	021306	5
AU	4604LN	613E	497 ANSI	2806, 6-Pin, Schlage® C Keyed Random	021307	5
AU	4604LN	613E	497 ANSI	2806, 6-Pin, Schlage® C 0-Bitted	021308	5
AU	4604LN	613E	497 ANSI	3806 x LA, Sargent LA Keyed Random	022618	5
AU	4604LN	613E	497 ANSI	3806 x LA, Sargent LA 0-Bitted	022610	5
AU	4604LN	626	497 ANSI	Less Cylinder	021309	5
AU	4604LN	626	497 ANSI	1806, 6-Pin, GA Keyed Random	021310	5
AU	4604LN	626	497 ANSI	1806, 6-Pin, GA 0-Bitted	021311	5
AU	4604LN	626	497 ANSI	1806, 6-Pin, PARA Keyed Random	021312	5
AU	4604LN	626	497 ANSI	1806, 6-Pin PARA 0-Bitted	021313	5
AU	4604LN	626	497 ANSI	2806, 6-Pin, Schlage® C Keyed Random	021314	5
AU	4604LN	626	497 ANSI	2806, 6-Pin, Schlage® C 0-Bitted	021315	5
AU	4604LN	626	497 ANSI	3806 x LA, Sargent LA Keyed Random	022619	5
AU	4604LN	626	497 ANSI	3806 x LA, Sargent LA 0-Bitted	022611	5
MO	4604LN	626	497 ANSI	Less Cylinder	021316	5
MO	4604LN	626	497 ANSI	1806, 6-Pin, GA Keyed Random	021317	5
MO	4604LN	626	497 ANSI	1806, 6-Pin, GA 0-Bitted	021318	5

Note: Yale reserves the right to limit quantities



Grade 2 Cylindrical Lever Locks

4600LN SERIES: 2-3/4" BACKSET



Augusta - AU



Monroe - MO



Pacific Beach - PB

DESIGN	MODEL #	FINISH	STRIKE	CYLINDER	QUICKSHIP #	APPROX. WEIGHT (LBS. EACH)
MO	4604LN	626	497 ANSI	1806, 6-Pin, PARA Keyed Random	021319	5
MO	4604LN	626	497 ANSI	1806, 6-Pin PARA 0-Bitted	021320	5
MO	4604LN	626	497 ANSI	2806, 6-Pin, Schlage® C Keyed Random	021321	5
MO	4604LN	626	497 ANSI	2806, 6-Pin, Schlage® C 0-Bitted	021322	5
PB	4604LN	613E	497 ANSI	Less Cylinder	021323	5
PB	4604LN	613E	497 ANSI	1806, 6-Pin, GA Keyed Random	021324	5
PB	4604LN	613E	497 ANSI	1806, 6-Pin, GA 0-Bitted	021325	5
PB	4604LN	613E	497 ANSI	1806, 6-Pin, PARA Keyed Random	021326	5
PB	4604LN	613E	497 ANSI	1806, 6-Pin PARA 0-Bitted	021327	5
PB	4604LN	613E	497 ANSI	2806, 6-Pin, Schlage® C Keyed Random	021328	5
PB	4604LN	613E	497 ANSI	2806, 6-Pin, Schlage® C 0-Bitted	021329	5
PB	4604LN	626	497 ANSI	Less Cylinder	021330	5
PB	4604LN	626	497 ANSI	1806, 6-Pin, GA Keyed Random	021331	5
PB	4604LN	626	497 ANSI	1806, 6-Pin, GA 0-Bitted	021332	5
PB	4604LN	626	497 ANSI	1806, 6-Pin, PARA Keyed Random	021333	5
PB	4604LN	626	497 ANSI	1806, 6-Pin PARA 0-Bitted	021334	5
PB	4604LN	626	497 ANSI	2806, 6-Pin, Schlage® C Keyed Random	021335	5
PB	4604LN	626	497 ANSI	2806, 6-Pin, Schlage® C 0-Bitted	021336	5
4605LN - STOREROOM OR CLOSET LOCK						
AU	4605LN	613E	497 ANSI	Less Cylinder	021337	5
AU	4605LN	613E	497 ANSI	1806, 6-Pin, GA Keyed Random	021338	5
AU	4605LN	613E	497 ANSI	1806, 6-Pin, GA 0-Bitted	021339	5
AU	4605LN	613E	497 ANSI	1806, 6-Pin, PARA Keyed Random	017179	5
AU	4605LN	613E	497 ANSI	1806, 6-Pin PARA 0-Bitted	017198	5
AU	4605LN	613E	497 ANSI	2806, 6-Pin, Schlage® C Keyed Random	017207	5
AU	4605LN	613E	497 ANSI	2806, 6-Pin, Schlage® C 0-Bitted	017216	5
AU	4605LN	613E	497 ANSI	3806 x LA, Sargent LA Keyed Random	022620	5
AU	4605LN	613E	497 ANSI	3806 x LA, Sargent LA 0-Bitted	022612	5
AU	4605LN	626	497 ANSI	Less Cylinder	021340	5
AU	4605LN	626	497 ANSI	1806, 6-Pin, GA Keyed Random	021341	5
AU	4605LN	626	497 ANSI	1806, 6-Pin, GA 0-Bitted	021342	5
AU	4605LN	626	497 ANSI	1806, 6-Pin, PARA Keyed Random	017131	5
AU	4605LN	626	497 ANSI	1806, 6-Pin PARA 0-Bitted	017150	5
AU	4605LN	626	497 ANSI	2806, 6-Pin, Schlage® C Keyed Random	017159	5

Note: Yale reserves the right to limit quantities



Grade 2 Cylindrical Lever Locks

4600LN SERIES: 2-3/4" BACKSET



Augusta - AU



Monroe - MO



Pacific Beach - PB

DESIGN	MODEL #	FINISH	STRIKE	CYLINDER	QUICKSHIP #	APPROX. WEIGHT (LBS. EACH)
AU	4605LN	626	497 ANSI	2806, 6-Pin, Schlage® C 0-Bitted	017168	5
AU	4605LN	626	497 ANSI	3806 x LA, Sargent LA Keyed Random	022621	5
AU	4605LN	626	497 ANSI	3806 x LA, Sargent LA 0-Bitted	022613	5
MO	4605LN	626	497 ANSI	Less Cylinder	021343	5
MO	4605LN	626	497 ANSI	1806, 6-Pin, GA Keyed Random	021344	5
MO	4605LN	626	497 ANSI	1806, 6-Pin, GA 0-Bitted	021345	5
MO	4605LN	626	497 ANSI	1806, 6-Pin, PARA Keyed Random	021346	5
MO	4605LN	626	497 ANSI	1806, 6-Pin PARA 0-Bitted	021347	5
MO	4605LN	626	497 ANSI	2806, 6-Pin, Schlage® C Keyed Random	021348	5
MO	4605LN	626	497 ANSI	2806, 6-Pin, Schlage® C 0-Bitted	021349	5
PB	4605LN	613E	497 ANSI	Less Cylinder	021350	5
PB	4605LN	613E	497 ANSI	1806, 6-Pin, GA Keyed Random	021351	5
PB	4605LN	613E	497 ANSI	1806, 6-Pin, GA 0-Bitted	021352	5
PB	4605LN	613E	497 ANSI	1806, 6-Pin, PARA Keyed Random	017186	5
PB	4605LN	613E	497 ANSI	1806, 6-Pin PARA 0-Bitted	017201	5
PB	4605LN	613E	497 ANSI	2806, 6-Pin, Schlage® C Keyed Random	017210	5
PB	4605LN	613E	497 ANSI	2806, 6-Pin, Schlage® C 0-Bitted	017219	5
PB	4605LN	626	497 ANSI	Less Cylinder	021353	5
PB	4605LN	626	497 ANSI	1806, 6-Pin, GA Keyed Random	021354	5
PB	4605LN	626	497 ANSI	1806, 6-Pin, GA 0-Bitted	021355	5
PB	4605LN	626	497 ANSI	1806, 6-Pin, PARA Keyed Random	017138	5
PB	4605LN	626	497 ANSI	1806, 6-Pin PARA 0-Bitted	017153	5
PB	4605LN	626	497 ANSI	2806, 6-Pin, Schlage® C Keyed Random	017162	5
PB	4605LN	626	497 ANSI	2806, 6-Pin, Schlage® C 0-Bitted	017171	5
4605LN - STOREROOM OR CLOSET LOCK (SMALL FORMAT INTERCHANGEABLE CORE)						
BAU	4605LN	613E	497 ANSI	Less Core	017821	5
BAU	4605LN	626	497 ANSI	Less Core	017815	5
BPB	4605LN	613E	497 ANSI	Less Core	017824	5
BPB	4605LN	626	497 ANSI	Less Core	017818	5
4607LN - ENTRY LOCK						
AU	4607LN	613E	497 ANSI	Less Cylinder	021356	5
AU	4607LN	613E	497 ANSI	1806, 6-Pin, GA Keyed Random	021357	5

Note: Yale reserves the right to limit quantities



Grade 2 Cylindrical Lever Locks

4600LN SERIES: 2-3/4" BACK



Augusta - AU



Monroe - MO



Pacific Beach - PB

DESIGN	MODEL #	FINISH	STRIKE	CYLINDER	QUICKSHIP #	APPROX. WEIGHT (LBS. EACH)
AU	4607LN	613E	497 ANSI	1806, 6-Pin, GA 0-Bitted	021358	5
AU	4607LN	613E	497 ANSI	1806, 6-Pin, PARA Keyed Random	017180	5
AU	4607LN	613E	497 ANSI	1806, 6-Pin PARA 0-Bitted	017199	5
AU	4607LN	613E	497 ANSI	2806, 6-Pin, Schlage® C Keyed Random	017208	5
AU	4607LN	613E	497 ANSI	2806, 6-Pin, Schlage® C 0-Bitted	017217	5
AU	4607LN	613E	497 ANSI	3806 x LA, Sargent LA Keyed Random	022622	5
AU	4607LN	613E	497 ANSI	3806 x LA, Sargent LA 0-Bitted	022614	5
AU	4607LN	626	497 ANSI	Less Cylinder	021359	5
AU	4607LN	626	497 ANSI	1806, 6-Pin, GA Keyed Random	021360	5
AU	4607LN	626	497 ANSI	1806, 6-Pin, GA 0-Bitted	021361	5
AU	4607LN	626	497 ANSI	1806, 6-Pin, PARA Keyed Random	017132	5
AU	4607LN	626	497 ANSI	1806, 6-Pin PARA 0-Bitted	017151	5
AU	4607LN	626	497 ANSI	2806, 6-Pin, Schlage® C Keyed Random	017160	5
AU	4607LN	626	497 ANSI	2806, 6-Pin, Schlage® C 0-Bitted	017169	5
AU	4607LN	626	497 ANSI	3806 x LA, Sargent LA Keyed Random	022623	5
AU	4607LN	626	497 ANSI	3806 x LA, Sargent LA 0-Bitted	022615	5
MO	4607LN	626	497 ANSI	Less Cylinder	021362	5
MO	4607LN	626	497 ANSI	1806, 6-Pin, GA Keyed Random	021363	5
MO	4607LN	626	497 ANSI	1806, 6-Pin, GA 0-Bitted	021364	5
MO	4607LN	626	497 ANSI	1806, 6-Pin, PARA Keyed Random	021365	5
MO	4607LN	626	497 ANSI	1806, 6-Pin PARA 0-Bitted	021366	5
MO	4607LN	626	497 ANSI	2806, 6-Pin, Schlage® C Keyed Random	021367	5
MO	4607LN	626	497 ANSI	2806, 6-Pin, Schlage® C 0-Bitted	021368	5
PB	4607LN	613E	497 ANSI	Less Cylinder	021369	5
PB	4607LN	613E	497 ANSI	1806, 6-Pin, GA Keyed Random	021370	5
PB	4607LN	613E	497 ANSI	1806, 6-Pin, GA 0-Bitted	021371	5
PB	4607LN	613E	497 ANSI	1806, 6-Pin, PARA Keyed Random	017187	5
PB	4607LN	613E	497 ANSI	1806, 6-Pin PARA 0-Bitted	017202	5
PB	4607LN	613E	497 ANSI	2806, 6-Pin, Schlage® C Keyed Random	017211	5
PB	4607LN	613E	497 ANSI	2806, 6-Pin, Schlage® C 0-Bitted	017220	5
PB	4607LN	626	497 ANSI	Less Cylinder	021372	5
PB	4607LN	626	497 ANSI	1806, 6-Pin, GA Keyed Random	021373	5
PB	4607LN	626	497 ANSI	1806, 6-Pin, GA 0-Bitted	021374	5
PB	4607LN	626	497 ANSI	1806, 6-Pin, PARA Keyed Random	017139	5
PB	4607LN	626	497 ANSI	1806, 6-Pin PARA 0-Bitted	017154	5

Note: Yale reserves the right to limit quantities



Grade 2 Cylindrical Lever Locks

4600LN SERIES: 2-3/4" BACKSET



Augusta - AU



Monroe - MO



Pacific Beach - PB

DESIGN	MODEL #	FINISH	STRIKE	CYLINDER	QUICKSHIP #	APPROX. WEIGHT (LBS. EACH)
PB	4607LN	626	497 ANSI	2806, 6-Pin, Schlage® C Keyed Random	017163	5
PB	4607LN	626	497 ANSI	2806, 6-Pin, Schlage® C 0-Bitted	017172	5
4607LN - ENTRY LOCK (SMALL FORMAT INTERCHANGEABLE CORE)						
BAU	4607LN	613E	497 ANSI	Less Core	017822	5
BAU	4607LN	626	497 ANSI	Less Core	017816	5
BPB	4607LN	613E	497 ANSI	Less Core	017825	5
BPB	4607LN	626	497 ANSI	Less Core	017819	5
4608LN - CLASSROOM LOCK						
AU	4608LN	613E	497 ANSI	Less Cylinder	021375	5
AU	4608LN	613E	497 ANSI	1806, 6-Pin, GA Keyed Random	021376	5
AU	4608LN	613E	497 ANSI	1806, 6-Pin, GA 0-Bitted	021377	5
AU	4608LN	613E	497 ANSI	1806, 6-Pin, PARA Keyed Random	017181	5
AU	4608LN	613E	497 ANSI	1806, 6-Pin PARA 0-Bitted	017200	5
AU	4608LN	613E	497 ANSI	2806, 6-Pin, Schlage® C Keyed Random	017209	5
AU	4608LN	613E	497 ANSI	2806, 6-Pin, Schlage® C 0-Bitted	017218	5
AU	4608LN	613E	497 ANSI	3806 x LA, Sargent LA Keyed Random	022624	5
AU	4608LN	613E	497 ANSI	3806 x LA, Sargent LA 0-Bitted	022616	5
AU	4608LN	626	497 ANSI	Less Cylinder	021378	5
AU	4608LN	626	497 ANSI	1806, 6-Pin, GA Keyed Random	021379	5
AU	4608LN	626	497 ANSI	1806, 6-Pin, GA 0-Bitted	021380	5
AU	4608LN	626	497 ANSI	1806, 6-Pin, PARA Keyed Random	017133	5
AU	4608LN	626	497 ANSI	1806, 6-Pin PARA 0-Bitted	017152	5
AU	4608LN	626	497 ANSI	2806, 6-Pin, Schlage® C Keyed Random	017161	5
AU	4608LN	626	497 ANSI	2806, 6-Pin, Schlage® C 0-Bitted	017170	5
AU	4608LN	626	497 ANSI	3806 x LA, Sargent LA Keyed Random	022625	5
AU	4608LN	626	497 ANSI	3806 x LA, Sargent LA 0-Bitted	022617	5
MO	4608LN	626	497 ANSI	Less Cylinder	021381	5
MO	4608LN	626	497 ANSI	1806, 6-Pin, GA Keyed Random	021382	5
MO	4608LN	626	497 ANSI	1806, 6-Pin, GA 0-Bitted	021383	5
MO	4608LN	626	497 ANSI	1806, 6-Pin, PARA Keyed Random	021384	5
MO	4608LN	626	497 ANSI	1806, 6-Pin PARA 0-Bitted	021385	5
MO	4608LN	626	497 ANSI	2806, 6-Pin, Schlage® C Keyed Random	021386	5
MO	4608LN	626	497 ANSI	2806, 6-Pin, Schlage® C 0-Bitted	021387	5
PB	4608LN	613E	497 ANSI	Less Cylinder	021388	5

Note: Yale reserves the right to limit quantities



Grade 2 Cylindrical Lever Locks

4600LN SERIES: 2-3/4" BACKSET



Augusta - AU



Monroe - MO



Pacific Beach - PB

DESIGN	MODEL #	FINISH	STRIKE	CYLINDER	QUICKSHIP #	APPROX. WEIGHT (LBS. EACH)
PB	4608LN	613E	497 ANSI	1806, 6-Pin, GA Keyed Random	021389	5
PB	4608LN	613E	497 ANSI	1806, 6-Pin, GA 0-Bitted	021390	5
PB	4608LN	613E	497 ANSI	1806, 6-Pin, PARA Keyed Random	017188	5
PB	4608LN	613E	497 ANSI	1806, 6-Pin PARA 0-Bitted	017203	5
PB	4608LN	613E	497 ANSI	2806, 6-Pin, Schlage® C Keyed Random	017212	5
PB	4608LN	613E	497 ANSI	2806, 6-Pin, Schlage® C 0-Bitted	017221	5
PB	4608LN	626	497 ANSI	Less Cylinder	021391	5
PB	4608LN	626	497 ANSI	1806, 6-Pin, GA Keyed Random	021392	5
PB	4608LN	626	497 ANSI	1806, 6-Pin, GA 0-Bitted	021393	5
PB	4608LN	626	497 ANSI	1806, 6-Pin, PARA Keyed Random	017140	5
PB	4608LN	626	497 ANSI	1806, 6-Pin PARA 0-Bitted	017155	5
PB	4608LN	626	497 ANSI	2806, 6-Pin, Schlage® C Keyed Random	017164	5
PB	4608LN	626	497 ANSI	2806, 6-Pin, Schlage® C 0-Bitted	017173	5
4608LN - CLASSROOM LOCK (SMALL FORMAT INTERCHANGEABLE CORE)						
BAU	4608LN	613E	497 ANSI	Less Core	017823	5
BAU	4608LN	626	497 ANSI	Less Core	017817	5
BPB	4608LN	613E	497 ANSI	Less Core	017826	5
BPB	4608LN	626	497 ANSI	Less Core	017820	5
4628LN - COMMUNICATING PASSAGE LOCK						
AU	4628LN	613E	497 ANSI	—	017182	5
AU	4628LN	626	497 ANSI	—	017134	5
MO	4628LN	626	497 ANSI	—	021394	5
PB	4628LN	613E	497 ANSI	—	017189	5
PB	4628LN	626	497 ANSI	—	017141	5
4655LN - DUMMY TRIM						
AU	4655LN	613E	—	—	017183	2
AU	4655LN	626	—	—	017135	2
MO	4655LN	626	—	—	021395	2
PB	4655LN	613E	—	—	017190	2
PB	4655LN	626	—	—	017142	2

Note: Yale reserves the right to limit quantities

QuickShip



Grade 2 Tubular Lever Locks

4300LN SERIES: 2-3/4" BACKSET



Augusta - AU



Pacific Beach - PB

DESIGN	MODEL #	FINISH	LATCH	STRIKE	CYLINDER	QUICKSHIP #	APPROX. WEIGHT (LBS. EACH)
4301LN - PASSAGE OR CLOSET LATCH							
AU	4301LN	626	280DN	497 ANSI	—	068540	3
AU	4301LN	626	280DN	271	—	065334	3
PB	4301LN	626	280DN	497 ANSI	—	066525	3
PB	4301LN	626	280DN	271	—	066531	3
4302LN - PRIVACY, BEDROOM OR BATH LOCK							
AU	4302LN	626	280DN	497 ANSI	—	068541	3
AU	4302LN	626	280DN	271	—	065335	3
PB	4302LN	626	280DN	497 ANSI	—	066526	3
PB	4302LN	626	280DN	271	—	066532	3
4305LN - STOREROOM OR CLOSET LOCK							
AU	4305LN	626	280DN	497 ANSI	Less Cylinder	068586	3
AU	4305LN	626	280DN	497 ANSI	1812, 6-Pin, PARA Keyed Random	065362	3
AU	4305LN	626	280DN	271	Less Cylinder	068268	3
AU	4305LN	626	280DN	271	1812, 6-Pin, PARA Keyed Random	067229	3
PB	4305LN	626	280DN	497 ANSI	Less Cylinder	066527	3
PB	4305LN	626	280DN	497 ANSI	1812, 6-Pin, PARA Keyed Random	066453	3
PB	4305LN	626	280DN	271	Less Cylinder	066533	3
PB	4305LN	626	280DN	271	1812, 6-Pin, PARA Keyed Random	066459	3
4307LN - ENTRY LOCK							
AU	4307LN	626	280DN	497 ANSI	Less Cylinder	068587	3
AU	4307LN	626	280DN	497 ANSI	1812, 6-Pin, PARA Keyed Random	068569	3
AU	4307LN	626	280DN	271	Less Cylinder	068269	3
AU	4307LN	626	280DN	271	1812, 6-Pin, PARA Keyed Random	067230	3
PB	4307LN	626	280DN	497 ANSI	Less Cylinder	066528	3
PB	4307LN	626	280DN	497 ANSI	1812, 6-Pin, PARA Keyed Random	066454	3
PB	4307LN	626	280DN	271	Less Cylinder	066534	3
PB	4307LN	626	280DN	271	1812, 6-Pin, PARA Keyed Random	066460	3

Note: Yale reserves the right to limit quantities



Grade 2 Tubular Lever Locks

4300LN SERIES: 2-3/4" BACKSET



Augusta - AU



Pacific Beach - PB

DESIGN	MODEL #	FINISH	LATCH	STRIKE	CYLINDER	QUICKSHIP #	APPROX. WEIGHT (LBS. EACH)
4308LN - CLASSROOM LOCK							
AU	4308LN	626	280DN	497 ANSI	Less Cylinder	068588	3
AU	4308LN	626	280DN	497 ANSI	1812, 6-Pin, PARA Keyed Random	068570	3
AU	4308LN	626	280DN	271	Less Cylinder	068270	3
AU	4308LN	626	280DN	271	1812, 6-Pin, PARA Keyed Random	067231	3
PB	4308LN	626	280DN	497 ANSI	Less Cylinder	066529	3
PB	4308LN	626	280DN	497 ANSI	1812, 6-Pin, PARA Keyed Random	066455	3
PB	4308LN	626	280DN	271	Less Cylinder	066535	3
PB	4308LN	626	280DN	271	1812, 6-Pin, PARA Keyed Random	066461	3
4328LN - COMMUNICATING PASSAGE LOCK							
AU	4328LN	626	280DN	497 ANSI	—	066326	3
AU	4328LN	626	280DN	271	—	066336	3
PB	4328LN	626	280DN	497 ANSI	—	066530	3
PB	4328LN	626	280DN	271	—	066536	3
4355LN - DUMMY TRIM							
AU	4355LN	626	—	—	—	068297	1
PB	4355LN	626	—	—	—	066627	1

Note: Yale reserves the right to limit quantities



Grade 2 Tubular Lever Locks

4300LN SERIES: 2-3/8" BACKSET



Augusta - AU



Pacific Beach - PB

DESIGN	MODEL #	FINISH	LATCH	STRIKE	CYLINDER	QUICKSHIP #	APPROX. WEIGHT (LBS. EACH)
4301LN - PASSAGE OR CLOSET LATCH							
AU	4301LN	626	280N	271	—	067100	3
AU	4301LN	626	280RN	271	—	065330	3
PB	4301LN	626	280N	271	—	066537	3
PB	4301LN	626	280RN	271	—	066543	3
4302LN - PRIVACY, BEDROOM OR BATH LOCK							
AU	4302LN	626	280N	271	—	067101	3
AU	4302LN	626	280RN	271	—	065331	3
PB	4302LN	626	280N	271	—	066538	3
PB	4302LN	626	280RN	271	—	066544	3
4305LN - STOREROOM OR CLOSET LOCK							
AU	4305LN	626	280N	271	Less Cylinder	068256	3
AU	4305LN	626	280N	271	1812, 6-Pin, PARA Keyed Random	067129	3
AU	4305LN	626	280RN	271	Less Cylinder	068280	3
AU	4305LN	626	280RN	271	1812, 6-Pin, PARA Keyed Random	067329	3
PB	4305LN	626	280N	271	Less Cylinder	066539	3
PB	4305LN	626	280N	271	1812, 6-Pin, PARA Keyed Random	066465	3
PB	4305LN	626	280RN	271	Less Cylinder	066545	3
PB	4305LN	626	280RN	271	1812, 6-Pin, PARA Keyed Random	066471	3
4307LN - ENTRY LOCK							
AU	4307LN	626	280N	271	Less Cylinder	068257	3
AU	4307LN	626	280N	271	1812, 6-Pin, PARA Keyed Random	067130	3
AU	4307LN	626	280RN	271	Less Cylinder	068281	3
AU	4307LN	626	280RN	271	1812, 6-Pin, PARA Keyed Random	065342	3
PB	4307LN	626	280N	271	Less Cylinder	066540	3
PB	4307LN	626	280N	271	1812, 6-Pin, PARA Keyed Random	066466	3
PB	4307LN	626	280RN	271	Less Cylinder	066546	3
PB	4307LN	626	280RN	271	1812, 6-Pin, PARA Keyed Random	066472	3

Note: Yale reserves the right to limit quantities



Grade 2 Tubular Lever Locks

4300LN SERIES: 2-3/8" BACKSET



Augusta - AU



Pacific Beach - PB

DESIGN	MODEL #	FINISH	LATCH	STRIKE	CYLINDER	QUICKSHIP #	APPROX. WEIGHT (LBS. EACH)
4308LN - CLASSROOM LOCK							
AU	4308LN	626	280N	271	Less Cylinder	068258	3
AU	4308LN	626	280N	271	1812, 6-Pin, PARA Keyed Random	067131	3
AU	4308LN	626	280RN	271	Less Cylinder	068282	3
AU	4308LN	626	280RN	271	1812, 6-Pin, PARA Keyed Random	067331	3
PB	4308LN	626	280N	271	Less Cylinder	066541	3
PB	4308LN	626	280N	271	1812, 6-Pin, PARA Keyed Random	066467	3
PB	4308LN	626	280RN	271	Less Cylinder	066547	3
PB	4308LN	626	280RN	271	1812, 6-Pin, PARA Keyed Random	066473	3
4328LN - COMMUNICATING PASSAGE LOCK							
AU	4328LN	626	280N	271	—	066346	3
AU	4328LN	626	280RN	271	—	066356	3
PB	4328LN	626	280N	271	—	066542	3
PB	4328LN	626	280RN	271	—	066548	3
4355LN - DUMMY TRIM							
AU	4355LN	626	—	—	—	068297	1
PB	4355LN	626	—	—	—	066627	1

Note: Yale reserves the right to limit quantities



Tubular Decorative Lever Locks

RL SERIES: 2-3/4" BACKSET



TB



TQ



TS



TY

DESIGN	MODEL #	FINISH	STRIKE	HAND	ROSE	QUICKSHIP #	APPROX. WEIGHT (LBS. EACH)
RL201 - PASSAGE OR CLOSET LATCH							
TBR3	RL201	626	371	RH	R3	021396	3.5
TQR3	RL201	626	371	RH	R3	021399	3.5
TSR3	RL201	626	371	RH	R3	021401	3.5
TYR3	RL201	626	371	RH	R3	021404	3.5
TYR3	RL201	626	371	LH	R3	021405	3.5
RL202 - PRIVACY, BEDROOM OR BATH LOCK							
TBR3	RL202	626	371	RH	R3	021406	3.5
TQR3	RL202	626	371	RH	R3	021409	3.5
TSR3	RL202	626	371	RH	R3	021411	3.5
TYR3	RL202	626	371	RH	R3	021414	3.5
TYR3	RL202	626	371	LH	R3	021415	3.5
RL228 - COMMUNICATING PASSAGE LOCK							
TBR3	RL228	626	371	RH	R3	021416	2.5
TQR3	RL228	626	371	RH	R3	021419	2.5
TSR3	RL228	626	371	RH	R3	021421	2.5
TYR3	RL228	626	371	RH	R3	021424	2.5
TYR3	RL228	626	371	LH	R3	021425	2.5
RL255 - DUMMY TRIM							
TBR3	RL255	626	—	RH	R3	021426	2
TQR3	RL255	626	—	RH	R3	021429	2
TSR3	RL255	626	—	RH	R3	021431	2
TYR3	RL255	626	—	RH	R3	021434	2
TYR3	RL255	626	—	LH	R3	021435	2
RL255D - DOUBLE DUMMY TRIM							
TBR3	RL255D	626	—	RH	R3	021436	2
TQR3	RL255D	626	—	RH	R3	021439	2
TSR3	RL255D	626	—	RH	R3	021441	2
TYR3	RL255D	626	—	RH	R3	021444	2
TYR3	RL255D	626	—	LH	R3	021445	2
RL255S - DUMMY TRIM - SURFACE							
TBR3	RL255S	626	—	RH	R3	021446	2
TQR3	RL255S	626	—	RH	R3	021449	2
TSR3	RL255S	626	—	RH	R3	021451	2
TYR3	RL255S	626	—	RH	R3	021454	2
TYR3	RL255S	626	—	LH	R3	021455	2

Note: Yale reserves the right to limit quantities



Grade 1 Cylindrical Knob Locks

4700 SERIES: 2-3/4" BACKSET



Carolina - CA

DESIGN	MODEL #	FINISH	STRIKE	CYLINDER	QUICKSHIP #	APPROX. WEIGHT (LBS. EACH)
5401CK - PASSAGE OR CLOSET LATCH						
CA	5401CK	630	497 ANSI	—	021520	3
5402CK - PRIVACY, BEDROOM OR BATH LOCK						
CA	5402CK	630	497 ANSI	—	021521	3
5405CK - STOREROOM OR CLOSET LOCK						
CA	5405CK	630	497 ANSI	Less Cylinder	021522	3
CA	5405CK	630	497 ANSI	1803-54K, 6-Pin, GA Keyed Random	021523	3
CA	5405CK	630	497 ANSI	1803-54K, 6-Pin, GA 0-Bitted	021524	3
CA	5405CK	630	497 ANSI	1803-54K, 6-Pin, PARA Keyed Random	021525	3
CA	5405CK	630	497 ANSI	1803-54K, 6-Pin, PARA 0-Bitted	021526	3
CA	5405CK	630	497 ANSI	2803-54K, 6-Pin, Schlage® C Keyed Random	021527	3
CA	5405CK	630	497 ANSI	2803-54K, 6-Pin, Schlage® C 0-Bitted	021528	3
5405CK - STOREROOM OR CLOSET LOCK (SMALL FORMAT INTERCHANGEABLE CORE)						
BCA	5405CK	630	497 ANSI	Less Core	021529	3
5407CK - ENTRY LOCK						
CA	5407CK	630	497 ANSI	Less Cylinder	021530	3
CA	5407CK	630	497 ANSI	1803-54K, 6-Pin, GA Keyed Random	021531	3
CA	5407CK	630	497 ANSI	1803-54K, 6-Pin, GA 0-Bitted	021532	3
CA	5407CK	630	497 ANSI	1803-54K, 6-Pin, PARA Keyed Random	021533	3
CA	5407CK	630	497 ANSI	1803-54K, 6-Pin, PARA 0-Bitted	021534	3
CA	5407CK	630	497 ANSI	2803-54K, 6-Pin, Schlage® C Keyed Random	021535	3
CA	5407CK	630	497 ANSI	2803-54K, 6-Pin, Schlage® C 0-Bitted	021536	3
5407CK - ENTRY LOCK (SMALL FORMAT INTERCHANGEABLE CORE)						
BCA	5407CK	630	497 ANSI	Less Core	021537	3
5408CK - CLASSROOM LOCK						
CA	5408CK	630	497 ANSI	Less Cylinder	021538	3
CA	5408CK	630	497 ANSI	1803-54K, 6-Pin, GA Keyed Random	021539	3
CA	5408CK	630	497 ANSI	1803-54K, 6-Pin, GA 0-Bitted	021540	3
CA	5408CK	630	497 ANSI	1803-54K, 6-Pin, PARA Keyed Random	021541	3
CA	5408CK	630	497 ANSI	1803-54K, 6-Pin, PARA 0-Bitted	021542	3
CA	5408CK	630	497 ANSI	2803-54K, 6-Pin, Schlage® C Keyed Random	021543	3
CA	5408CK	630	497 ANSI	2803-54K, 6-Pin, Schlage® C 0-Bitted	021544	3
5408CK - CLASSROOM LOCK (SMALL FORMAT INTERCHANGEABLE CORE)						
BCA	5408CK	630	497 ANSI	Less Core	021545	3

Note: Yale reserves the right to limit quantities



Grade 2 Cylindrical Knob Locks

4600 SERIES: 2-3/4" BACKSET



Carolina - CA

DESIGN	MODEL #	FINISH	STRIKE	CYLINDER	QUICKSHIP #	APPROX. WEIGHT (LBS. EACH)
4601 - PASSAGE OR CLOSET LATCH						
CA	4601	630	371	—	017143	2
4602 - PRIVACY, BEDROOM OR BATH LOCK						
CA	4602	630	371	—	017144	2
4605 - STOREROOM OR CLOSET LOCK						
CA	4605	630	371	Less Cylinder	021482	2.5
CA	4605	630	371	1805, 6-Pin, GA Keyed Random	021483	2.5
CA	4605	630	371	1805, 6-Pin, GA 0-Bitted	021484	2.5
CA	4605	630	371	1805, 6-Pin, PARA Keyed Random	017145	2.5
CA	4605	630	371	1805, 6-Pin, PARA 0-Bitted	017156	2.5
CA	4605	630	371	2805, 6-Pin, Schlage® C Keyed Random	017165	2.5
CA	4605	630	371	2805, 6-Pin, Schlage® C 0-Bitted	017174	2.5
4605 - STOREROOM OR CLOSET LOCK (SMALL FORMAT INTERCHANGEABLE CORE)						
BCA	4605	630	371	Less Core	017827	2.5
4607 - ENTRY LOCK						
CA	4607	630	371	Less Cylinder	021485	2.5
CA	4607	630	371	1805, 6-Pin, GA Keyed Random	021486	2.5
CA	4607	630	371	1805, 6-Pin, GA 0-Bitted	021487	2.5
CA	4607	630	371	1805, 6-Pin, PARA Keyed Random	017146	2.5
CA	4607	630	371	1805, 6-Pin, PARA 0-Bitted	017157	2.5
CA	4607	630	371	2805, 6-Pin, Schlage® C Keyed Random	017166	2.5
CA	4607	630	371	2805, 6-Pin, Schlage® C 0-Bitted	017175	2.5
4607 - ENTRY LOCK (SMALL FORMAT INTERCHANGEABLE CORE)						
BCA	4607	630	371	Less Core	017828	2.5
4608 - CLASSROOM LOCK						
CA	4608	630	371	Less Cylinder	021488	2.5
CA	4608	630	371	1805, 6-Pin, GA Keyed Random	021489	2.5
CA	4608	630	371	1805, 6-Pin, GA 0-Bitted	021490	2.5
CA	4608	630	371	1805, 6-Pin, PARA Keyed Random	017147	2.5
CA	4608	630	371	1805, 6-Pin, PARA 0-Bitted	017158	2.5
CA	4608	630	371	2805, 6-Pin, Schlage® C Keyed Random	017167	2.5
CA	4608	630	371	2805, 6-Pin, Schlage® C 0-Bitted	017176	2.5
4608 - CLASSROOM LOCK (SMALL FORMAT INTERCHANGEABLE CORE)						
BCA	4608	630	371	Less Core	017829	2.5
4655 - DUMMY TRIM						
CA	4655	630	—	—	066685	1

Note: Yale reserves the right to limit quantities



Grades 1 & 2 Cylindrical/Tubular Locks

CYLINDRICAL/TUBULAR CYLINDERS

MODEL #	DESCRIPTION	KEY SECTION	FINISH	QUICKSHIP #	APPROX. WEIGHT (LBS. EACH)
COMPONENT CYLINDERS					
FOR USE WITH 5400LN AND 5300LN LEVER LOCKS*					
1802	6-Pin, Keyed Random	GA	626	002786	0.2
1802	6-Pin, 0-Bitted	GA	626	002782	0.2
1802	6-Pin, Keyed Random	PARA	626	002785	0.2
1802	6-Pin, 0-Bitted	PARA	626	002798	0.2
2802	6-Pin, Schlage® Keyed Random	C	626	001899	0.2
2802	6-Pin, Schlage® 0-Bitted	C	626	001897	0.2
FOR USE WITH 4700LN LEVER LOCKS*					
1804	6-Pin, Keyed Random	GA	626	022526	0.2
1804	6-Pin, 0-Bitted	GA	626	022527	0.2
1804	6-Pin, Keyed Random	PARA	626	022528	0.2
1804	6-Pin, 0-Bitted	PARA	626	022529	0.2
2804	6-Pin, Schlage® Keyed Random	C	626	022530	0.2
2804	6-Pin, Schlage® 0-Bitted	C	626	022531	0.2
FOR USE WITH 4700 AND 4600 KNOB LOCKS					
1805	6-Pin, Keyed Random	GA	606	022006	0.2
1805	6-Pin, 0-Bitted	GA	606	022007	0.2
1805	6-Pin, Keyed Random	PARA	606	022008	0.2
1805	6-Pin, 0-Bitted	PARA	606	022009	0.2
2805	6-Pin, Schlage® Keyed Random	C	606	022014	0.2
2805	6-Pin, Schlage® 0-Bitted	C	606	022015	0.2
1805	6-Pin, Keyed Random	GA	626	022010	0.2
1805	6-Pin, 0-Bitted	GA	626	022011	0.2
1805	6-Pin, Keyed Random	PARA	626	022012	0.2
1805	6-Pin, 0-Bitted	PARA	626	022013	0.2
2805	6-Pin, Schlage® Keyed Random	C	626	022016	0.2
2805	6-Pin, Schlage® 0-Bitted	C	626	022017	0.2
FOR USE WITH 4600LN LEVER LOCKS					
1806	6-Pin, Keyed Random	GA	606	022018	0.2
1806	6-Pin, 0-Bitted	GA	606	022019	0.2
1806	6-Pin, Keyed Random	PARA	606	022020	0.2
1806	6-Pin, 0-Bitted	PARA	606	022021	0.2
2806	6-Pin, Schlage® Keyed Random	C	606	022026	0.2
2806	6-Pin, Schlage® 0-Bitted	C	606	022027	0.2
1806	6-Pin, Keyed Random	GA	626	022022	0.2
1806	6-Pin, 0-Bitted	GA	626	022023	0.2
1806	6-Pin, Keyed Random	PARA	626	022024	0.2
1806	6-Pin, 0-Bitted	PARA	626	022025	0.2
2806	6-Pin, Schlage® Keyed Random	C	626	022028	0.2
2806	6-Pin, Schlage® 0-Bitted	C	626	022029	0.2

***Note: Cylinders used with 5300LN and 4700LN series require 9053 cylinder sleeve, this sleeve is already packed with 5300LN and 4700LN locks and 1804/2804 cylinders
Yale reserves the right to limit quantities**



Grades 1 & 2 Cylindrical/Tubular Locks

CYLINDRICAL/TUBULAR CYLINDERS

MODEL #	DESCRIPTION	KEY SECTION	FINISH	QUICKSHIP #	APPROX. WEIGHT (LBS. EACH)
FOR USE WITH 4300LN LEVER LOCKS					
1812	6-Pin, Keyed Random	GA	626	075146	0.2
1812	6-Pin, 0-Bitted	GA	626	075145	0.2
1812	6-Pin, Keyed Random	PARA	626	075150	0.2
1812	6-Pin, 0-Bitted	PARA	626	075149	0.2
2812	6-Pin, Schlage® Keyed Random	C	626	075153	0.2
2812	6-Pin, Schlage® 0-Bitted	C	626	022031	0.2
INTERCHANGEABLE CORES (LARGE FORMAT)					
1210	Core Only, 6-Pin, 0-Bitted	GA	626	001783	0.3
1210	Core Only, 6-Pin, 0-Bitted	PARA	626	001791	0.0
GRADE 2 & TUBULAR LATCHBOLTS					
378N	Plain, 2-3/8" Backset, 1" Universal Front	—	626	001356	0.2
380N	Deadlocking, 2-3/8" Backset, 1" Universal Front	—	626	001359	0.2
MCP238	Plain, 2-3/8" Backset, 1" Square Front	—	613	017126	0.2
MCP238	Plain, 2-3/8" Backset, 1" Square Front	—	626	017125	0.2
MCD238	Deadlocking, 2-3/8" Backset, 1" Square Front	—	613	017124	0.2
MCD238	Deadlocking, 2-3/8" Backset, 1" Square Front	—	626	017128	0.2
RLP38A	Plain, 2-3/8" Backset, 1" Square Front (for passage functions)	—	626	021510	0.2
RLP38	Plain, 2-3/8" Backset, 1" Square Front (for privacy function)	—	626	021513	0.2
STRIKES					
497	ANSI Strike, 1-1/4" Lip	—	613	001574	0.2
497	ANSI Strike, 1-1/4" Lip	—	626	001571	0.2
371	T-Strike, 1-1/4" Lip	—	613	017957	0.1
371	T-Strike, 1-1/4" Lip	—	626	001353	0.1
70S	Full Lip, Square Corner	—	613	017960	0.1
70S	Full Lip, Square Corner	—	626	001348	0.1
71S	Full Lip, Round Corner	—	613	021511	0.1
71S	Full Lip, Round Corner	—	626	021512	0.1
MISCELLANEOUS					
10C	Fire Cup for UL Rating	—	—	075074	0.1
301	Dust Box for 2-3/4" Strike	—	—	075122	0.1
302	Dust Box for 2-1/4" Strike	—	—	075123	0.1
107S	Schlage® Tailpiece Kit	—	—	001892	0.3
108S	Schlage® Adaptor Kit	—	—	001891	0.3
202	Strike Box	—	—	001772	0.2
9053	Cylinder Sleeve	—	—	001560	0.5
	5400LN Spacer Kit for 1-3/8" Door (2 Rings)	—	693	001661	0.5

Note: Yale reserves the right to limit quantities



Auxiliary Locks

D SERIES CYLINDRICAL DEADBOLTS: 2-3/4" BACKSET



MODEL #	FINISH	STRIKE	CYLINDER	QUICKSHIP #	APPROX. WEIGHT (LBS. EACH)
GRADE 1					
CYLINDER X THUMBTURN					
D112	613	D243	1807, 6-Pin, GA Keyed Random	022074	2
D112	613	D243	1807, 6-Pin, GA 0-Bitted	022075	2
D112	613	D243	1807, 6-Pin, PARA Keyed Random	022076	2
D112	613	D243	1807, 6-Pin, PARA 0-Bitted	022077	2
D112	613	D243	2807, 6-Pin, Schlage® C Keyed Random	022078	2
D112	613	D243	2807, 6-Pin, Schlage® C 0-Bitted	022079	2
D112	626	D243	1807, 6-Pin, GA Keyed Random	022080	2
D112	626	D243	1807, 6-Pin, GA 0-Bitted	022081	2
D112	626	D243	1807, 6-Pin, PARA Keyed Random	022082	2
D112	626	D243	1807, 6-Pin, PARA 0-Bitted	022083	2
D112	626	D243	2807, 6-Pin, Schlage® C Keyed Random	022084	2
D112	626	D243	2807, 6-Pin, Schlage® C 0-Bitted	022085	2
CYLINDER X THUMBTURN (SMALL FORMAT INTERCHANGEABLE CORE)					
B-D112	613	D243	Less Core	022086	2
B-D112	626	D243	Less Core	022087	2
CYLINDER X CYLINDER					
D122	613	D243	1808, 6-Pin, GA Keyed Random	022088	2
D122	613	D243	1808, 6-Pin, GA 0-Bitted	022089	2
D122	613	D243	1808, 6-Pin, PARA Keyed Random	022090	2
D122	613	D243	1808, 6-Pin, PARA 0-Bitted	022091	2
D122	613	D243	2808, 6-Pin, Schlage® C Keyed Random	022092	2
D122	613	D243	2808, 6-Pin, Schlage® C 0-Bitted	022093	2
D122	626	D243	1808, 6-Pin, GA Keyed Random	022094	2
D122	626	D243	1808, 6-Pin, GA 0-Bitted	022095	2
D122	626	D243	1808, 6-Pin, PARA Keyed Random	022096	2
D122	626	D243	1808, 6-Pin, PARA 0-Bitted	022097	2
D122	626	D243	2808, 6-Pin, Schlage® C Keyed Random	022098	2
D122	626	D243	2808, 6-Pin, Schlage® C 0-Bitted	022099	2
CYLINDER X CYLINDER (SMALL FORMAT INTERCHANGEABLE CORE)					
B-D122	613	D243	Less Core	022100	2
B-D122	626	D243	Less Core	022101	2

Note: Yale reserves the right to limit quantities



Auxiliary Locks

D SERIES CYLINDRICAL DEADBOLTS: 2-3/4" BACKSET



MODEL #	FINISH	STRIKE	CYLINDER	QUICKSHIP #	APPROX. WEIGHT (LBS. EACH)
CYLINDER X BLANK ROSE					
D132	613	D243	1807, 6-Pin, GA Keyed Random	022102	2
D132	613	D243	1807, 6-Pin, GA 0-Bitted	022103	2
D132	613	D243	1807, 6-Pin, PARA Keyed Random	022104	2
D132	613	D243	1807, 6-Pin, PARA 0-Bitted	022105	2
D132	613	D243	2807, 6-Pin, Schlage® C Keyed Random	022106	2
D132	613	D243	2807, 6-Pin, Schlage® C 0-Bitted	022107	2
D132	626	D243	1807, 6-Pin, GA Keyed Random	022108	2
D132	626	D243	1807, 6-Pin, GA 0-Bitted	022109	2
D132	626	D243	1807, 6-Pin, PARA Keyed Random	022110	2
D132	626	D243	1807, 6-Pin, PARA 0-Bitted	022111	2
D132	626	D243	2807, 6-Pin, Schlage® C Keyed Random	022112	2
D132	626	D243	2807, 6-Pin, Schlage® C 0-Bitted	022113	2
BLANK PLATE X THUMBTURN					
D142	613	D243	—	022114	2
D142	626	D243	—	022115	2
BLANK PLATE X CYLINDER					
D152	613	D243	1807, 6-Pin, GA Keyed Random	022116	2
D152	613	D243	1807, 6-Pin, GA 0-Bitted	022117	2
D152	613	D243	1807, 6-Pin, PARA Keyed Random	022118	2
D152	613	D243	1807, 6-Pin, PARA 0-Bitted	022119	2
D152	613	D243	2807, 6-Pin, Schlage® C Keyed Random	022120	2
D152	613	D243	2807, 6-Pin, Schlage® C 0-Bitted	022121	2
D152	626	D243	1807, 6-Pin, GA Keyed Random	022122	2
D152	626	D243	1807, 6-Pin, GA 0-Bitted	022123	2
D152	626	D243	1807, 6-Pin, PARA Keyed Random	022124	2
D152	626	D243	1807, 6-Pin, PARA 0-Bitted	022125	2
D152	626	D243	2807, 6-Pin, Schlage® C Keyed Random	022126	2
D152	626	D243	2807, 6-Pin, Schlage® C 0-Bitted	022127	2
BLANK PLATE X CYLINDER (SMALL FORMAT INTERCHANGEABLE CORE)					
B-D152	613	D243	Less Core	022128	2
B-D152	626	D243	Less Core	022129	2

Note: Yale reserves the right to limit quantities



Auxiliary Locks

D SERIES CYLINDRICAL DEADBOLTS: 2-3/4" BACKSET



MODEL #	FINISH	STRIKE	CYLINDER	QUICKSHIP #	APPROX. WEIGHT (LBS. EACH)
CYLINDER X CLASSROOM THUMBTURN					
D162	613	D243	1807, 6-Pin, GA Keyed Random	022130	2
D162	613	D243	1807, 6-Pin, GA 0-Bitted	022131	2
D162	613	D243	1807, 6-Pin, PARA Keyed Random	022132	2
D162	613	D243	1807, 6-Pin, PARA 0-Bitted	022133	2
D162	613	D243	2807, 6-Pin, Schlage® C Keyed Random	022134	2
D162	613	D243	2807, 6-Pin, Schlage® C 0-Bitted	022135	2
D162	626	D243	1807, 6-Pin, GA Keyed Random	022136	2
D162	626	D243	1807, 6-Pin, GA 0-Bitted	022137	2
D162	626	D243	1807, 6-Pin, PARA Keyed Random	022138	2
D162	626	D243	1807, 6-Pin, PARA 0-Bitted	022139	2
D162	626	D243	2807, 6-Pin, Schlage® C Keyed Random	022140	2
D162	626	D243	2807, 6-Pin, Schlage® C 0-Bitted	022141	2
CYLINDER X CLASSROOM THUMBTURN (SMALL FORMAT INTERCHANGEABLE CORE)					
B-D162	613	D243	Less Core	022142	2
B-D162	626	D243	Less Core	022143	2
GRADE 2					
CYLINDER X THUMBTURN					
D212	613	D243	1807, 6-Pin, GA Keyed Random	022144	2
D212	613	D243	1807, 6-Pin, GA 0-Bitted	022145	2
D212	613	D243	1807, 6-Pin, PARA Keyed Random	017259	2
D212	613	D243	1807, 6-Pin, PARA 0-Bitted	017265	2
D212	613	D243	2807, 6-Pin, Schlage® C Keyed Random	017271	2
D212	613	D243	2807, 6-Pin, Schlage® C 0-Bitted	017277	2
D212	626	D243	1807, 6-Pin, GA Keyed Random	022146	2
D212	626	D243	1807, 6-Pin, GA 0-Bitted	022147	2
D212	626	D243	1807, 6-Pin, PARA Keyed Random	017235	2
D212	626	D243	1807, 6-Pin, PARA 0-Bitted	017241	2
D212	626	D243	2807, 6-Pin, Schlage® C Keyed Random	017247	2
D212	626	D243	2807, 6-Pin, Schlage® C 0-Bitted	017253	2
CYLINDER X THUMBTURN (SMALL FORMAT INTERCHANGEABLE CORE)					
B-D212	613	D243	Less Core	017736	2
B-D212	626	D243	Less Core	017730	2

Note: Yale reserves the right to limit quantities



Auxiliary Locks

D SERIES CYLINDRICAL DEADBOLTS: 2-3/4" BACKSET



MODEL #	FINISH	STRIKE	CYLINDER	QUICKSHIP #	APPROX. WEIGHT (LBS. EACH)
CYLINDER X CYLINDER					
D222	613	D243	1808, 6-Pin, GA Keyed Random	022148	2
D222	613	D243	1808, 6-Pin, GA 0-Bitted	022149	2
D222	613	D243	1808, 6-Pin, PARA Keyed Random	017261	2
D222	613	D243	1808, 6-Pin, PARA 0-Bitted	017267	2
D222	613	D243	2808, 6-Pin, Schlage® C Keyed Random	017273	2
D222	613	D243	2808, 6-Pin, Schlage® C 0-Bitted	017279	2
D222	626	D243	1808, 6-Pin, GA Keyed Random	022150	2
D222	626	D243	1808, 6-Pin, GA 0-Bitted	022151	2
D222	626	D243	1808, 6-Pin, PARA Keyed Random	017237	2
D222	626	D243	1808, 6-Pin, PARA 0-Bitted	017243	2
D222	626	D243	2808, 6-Pin, Schlage® C Keyed Random	017249	2
D222	626	D243	2808, 6-Pin, Schlage® C 0-Bitted	017255	2
CYLINDER X CYLINDER (SMALL FORMAT INTERCHANGEABLE CORE)					
B-D222	613	D243	Less Core	017738	2
B-D222	626	D243	Less Core	017732	2
CYLINDER X BLANK ROSE					
D232	613	D243	1807, 6-Pin, GA Keyed Random	022152	2
D232	613	D243	1807, 6-Pin, GA 0-Bitted	022153	2
D232	613	D243	1807, 6-Pin, PARA Keyed Random	017263	2
D232	613	D243	1807, 6-Pin, PARA 0-Bitted	017269	2
D232	613	D243	2807, 6-Pin, Schlage® C Keyed Random	017275	2
D232	613	D243	2807, 6-Pin, Schlage® C 0-Bitted	017281	2
D232	626	D243	1807, 6-Pin, GA Keyed Random	022154	2
D232	626	D243	1807, 6-Pin, GA 0-Bitted	022155	2
D232	626	D243	1807, 6-Pin, PARA Keyed Random	017239	2
D232	626	D243	1807, 6-Pin, PARA 0-Bitted	017245	2
D232	626	D243	2807, 6-Pin, Schlage® C Keyed Random	017251	2
D232	626	D243	2807, 6-Pin, Schlage® C 0-Bitted	017257	2
BLANK PLATE X THUMBTURN					
D242	613	D243	—	017285	2
D242	626	D243	—	017284	2

Note: Yale reserves the right to limit quantities



Auxiliary Locks

D SERIES CYLINDRICAL DEADBOLTS: 2-3/4" BACKSET



MODEL #	FINISH	STRIKE	CYLINDER	QUICKSHIP #	APPROX. WEIGHT (LBS. EACH)
BLANK PLATE X CYLINDER					
D252	613	D243	1807, 6-Pin, GA Keyed Random	022156	2
D252	613	D243	1807, 6-Pin, GA 0-Bitted	022157	2
D252	613	D243	1807, 6-Pin, PARA Keyed Random	022158	2
D252	613	D243	1807, 6-Pin, PARA 0-Bitted	022159	2
D252	613	D243	2807, 6-Pin, Schlage® C Keyed Random	022160	2
D252	613	D243	2807, 6-Pin, Schlage® C 0-Bitted	022161	2
D252	626	D243	1807, 6-Pin, GA Keyed Random	022162	2
D252	626	D243	1807, 6-Pin, GA 0-Bitted	022163	2
D252	626	D243	1807, 6-Pin, PARA Keyed Random	022164	2
D252	626	D243	1807, 6-Pin, PARA 0-Bitted	022165	2
D252	626	D243	2807, 6-Pin, Schlage® C Keyed Random	022166	2
D252	626	D243	2807, 6-Pin, Schlage® C 0-Bitted	022167	2
BLANK PLATE X CYLINDER (SMALL FORMAT INTERCHANGEABLE CORE)					
B-D252	613	D243	Less Core	022168	2
B-D252	626	D243	Less Core	022169	2
CYLINDER X CLASSROOM THUMBTURN					
D262	613	D243	1807, 6-Pin, GA Keyed Random	022170	2
D262	613	D243	1807, 6-Pin, GA 0-Bitted	022171	2
D262	613	D243	1807, 6-Pin, PARA Keyed Random	022172	2
D262	613	D243	1807, 6-Pin, PARA 0-Bitted	022173	2
D262	613	D243	2807, 6-Pin, Schlage® C Keyed Random	022174	2
D262	613	D243	2807, 6-Pin, Schlage® C 0-Bitted	022175	2
D262	626	D243	1807, 6-Pin, GA Keyed Random	022176	2
D262	626	D243	1807, 6-Pin, GA 0-Bitted	022177	2
D262	626	D243	1807, 6-Pin, PARA Keyed Random	022178	2
D262	626	D243	1807, 6-Pin, PARA 0-Bitted	022179	2
D262	626	D243	2807, 6-Pin, Schlage® C Keyed Random	022180	2
D262	626	D243	2807, 6-Pin, Schlage® C 0-Bitted	022181	2
CYLINDER X CLASSROOM THUMBTURN (SMALL FORMAT INTERCHANGEABLE CORE)					
B-D262	613	D243	Less Core	022182	2
B-D262	626	D243	Less Core	022183	2
OCCUPANCY INDICATOR X THUMBTURN					
D292	613	D243	—	020725	2
D292	626	D243	—	020724	2
D100 & D200 SERIES ACCESSORIES					
DEADBOLT ASSEMBLIES					
D38	613	—	2-3/8" Backset, 2-1/4" x 1" Front, 1" Throw	017966	1
D38	626	—	2-3/8" Backset, 2-1/4" x 1" Front, 1" Throw	017965	1



Auxiliary Locks

350 SERIES: MORTISE DEADLOCKS



MODEL #	DESCRIPTION	FINISH	STRIKE	CYLINDER	QUICKSHIP #	APPROX WEIGHT (LBS. EACH)
351	Cylinder x Cylinder	626	30S	Less Cylinder	022184	2
352	Cylinder x Thumbturn	626	30S	Less Cylinder	022185	2
353	Cylinder x Blank Plate	626	30S	Less Cylinder	022186	2
357	Cylinder x Thumbturn, Classroom Function	626	30S	Less Cylinder	022187	2

Note: Yale reserves the right to limit quantities



Auxiliary Locks

RIM AND CABINET LOCKS



112
Rim Deadbolt



80
Security Latchlock



197
Jimmy-Proof Deadlock



511
Cabinet Lock

MODEL #	DESCRIPTION	FINISH	CYLINDER	QUICKSHIP #	APPROX. WEIGHT (LBS. EACH)
112 SERIES HEAVY-DUTY RIM DEADBOLTS					
112	Cylinder x Thumbturn	696	1109E, 5-Pin, PARA Keyed Random	000424	2
112F	Cylinder x Thumbturn for Outswing Doors	696	1109E, 5-Pin, PARA Keyed Random	000398	2
112-1/4	Cylinder x Cylinder	696	1109E, 5-Pin, PARA Keyed Random	000427	2
112-1/4F	Cylinder x Cylinder for Outswing Doors	696	1109E, 5-Pin, PARA Keyed Random	000399	2
80 SERIES SECURITY LATCHLOCKS					
80	Cylinder x Thumbturn	696	1109E, 5-Pin, PARA Keyed Random	000403	1
88	Cylinder x Handle	689	1109E, 5-Pin, PARA Keyed Random	000608	2
197 SERIES JIMMY-PROOF DEADLOCKS					
197	Cylinder x Thumbturn	691	1109E, 5-Pin, PARA Keyed Random	000406	2
197F	Cylinder by Thumbturn for Outswing Doors	691	1109E, 5-Pin, PARA Keyed Random	000418	2
197-1/4	Cylinder x Cylinder	691	1109E, 5-Pin, PARA Keyed Random	000407	2
197-1/4F	Cylinder x Cylinder for Outswing Doors	691	1109E, 5-Pin, PARA Keyed Random	000419	2
511 SERIES CABINET LOCK					
511S	Key Retracts Latchbolt x RH x 3/4"	605	4-Pin, PARA KA47	002501	3
STRIKES					
197F	Flat Strike for 197F and 197F-1/4 Outswing Doors	691	—	000450	0.2
8RB	Rim Strike for 80 and 88 Outswing Doors	696	—	000451	0.2
112F	Flat Strike for 112F and 112-1/4F Outswing Doors	696	—	000452	0.2

Note: 1109E depths and spacings are not compatible with other cylinders available from Yale Locks & Hardware. The 1109E is not available as a replacement cylinder. Yale reserves the right to limit quantities



7000 Series Architectural Exit Devices

7100 SERIES: WIDE STILE ARCHITECTURAL



7150 SquareBolt®



7110 Surface Vertical Rod

MODEL #	DESCRIPTION	FINISH	HAND	STRIKE	QUICKSHIP #	APPROX. WEIGHT (LBS. EACH)
7150 - SQUAREBOLT®						
7150-36	SquareBolt® Exit Device, 36"	630	—	757F	003966	17
7150-48	SquareBolt® Exit Device, 48"	630	—	757F	003962	18
7150F-36	3 Hour Fire Rated SquareBolt® Exit Device, 36"	630	—	757F	003967	17
7150F-48	3 Hour Fire Rated SquareBolt® Exit Device, 48"	630	—	757F	003843	18
7100 - RIM						
7100-36	Rim Exit Device, 36"	630	—	757F	003884	14
7100-48	Rim Exit Device, 48"	630	—	757F	003882	17
7100F-36	3 Hour Fire Rated Rim Exit Device, 36"	630	—	757F	003885	14
7100F-48	3 Hour Fire Rated Rim Exit Device, 48"	630	—	757F	003883	17
7110 - SURFACE VERTICAL ROD						
7110-36	SVR Exit Device, 36"	630	RHR	791 Top, 790 Bottom	003886	18
7110-36	SVR Exit Device, 36"	630	LHR	791 Top, 790 Bottom	003963	18
7110F-36	3 Hour Fire Rated SVR Exit Device, 36"	630	RHR	791 Top, 790 Bottom	003964	18
7110F-36	3 Hour Fire Rated SVR Exit Device, 36"	630	LHR	791 Top, 790 Bottom	003965	18
7110-48	SVR Exit Device, 48"	630	RHR	791 Top, 790 Bottom	021600	22
7110-48	SVR Exit Device, 48"	630	LHR	791 Top, 790 Bottom	021601	22
7110F-48	3 Hour Fire Rated SVR Exit Device, 48"	630	RHR	791 Top, 790 Bottom	003622	22
7110F-48	3 Hour Fire Rated SVR Exit Device, 48"	630	LHR	791 Top, 790 Bottom	003623	22
7170 - SURFACE VERTICAL ROD - LBR						
7170F90LBR	90 Minute Fire Rated SVR Exit Device, Less Bottom Rod, 36"	630	—	726	003534	22

Note: Yale reserves the right to limit quantities



7000 Series Architectural Exit Devices

2100 SERIES: WIDE STILE FLATBAR



2150 SquareBolt®



2100 Rim

MODEL #	DESCRIPTION	FINISH	STRIKE	QUICKSHIP #	APPROX. WEIGHT (LBS. EACH)
2150 - SQUAREBOLT®					
2150-36	SquareBolt® Exit Device, 36"	630	757F	021602	11
2150-36	SquareBolt® Exit Device, 36"	689	757F	021603	11
2150-42	SquareBolt® Exit Device, 42"	630	757F	021604	11
2150-42	SquareBolt® Exit Device, 42"	689	757F	021605	11
2150-48	SquareBolt® Exit Device, 48"	630	757F	021606	11
2150-48	SquareBolt® Exit Device, 48"	689	757F	021607	11
2150F-36	3 Hour Fire Rated SquareBolt® Exit Device, 36"	630	757F	021608	11
2150F-36	3 Hour Fire Rated SquareBolt® Exit Device, 36"	689	757F	021609	11
2150F-42	3 Hour Fire Rated SquareBolt® Exit Device, 42"	630	757F	021610	11
2150F-42	3 Hour Fire Rated SquareBolt® Exit Device, 42"	689	757F	021611	11
2150F-48	3 Hour Fire Rated SquareBolt® Exit Device, 48"	630	757F	021612	11
2150F-48	3 Hour Fire Rated SquareBolt® Exit Device, 48"	689	757F	021613	11
2100 - RIM					
2100-36	Rim Exit Device, 36"	630	757F	003278	11
2100-36	Rim Exit Device, 36"	689	757F	003280	11
2100-42	Rim Exit Device, 42"	630	757F	017381	11
2100-42	Rim Exit Device, 42"	689	757F	017664	11
2100-48	Rim Exit Device, 48"	630	757F	017382	11
2100-48	Rim Exit Device, 48"	689	757F	017666	11
2100F-36	3 Hour Fire Rated Rim Exit Device, 36"	630	757F	003277	11
2100F-36	3 Hour Fire Rated Rim Exit Device, 36"	689	757F	003289	11
2100F-42	3 Hour Fire Rated Rim Exit Device, 42"	630	757F	017384	11
2100F-42	3 Hour Fire Rated Rim Exit Device, 42"	689	757F	017670	11
2100F-48	3 Hour Fire Rated Rim Exit Device, 48"	630	757F	017385	11
2100F-48	3 Hour Fire Rated Rim Exit Device, 48"	689	757F	017672	11

Note: Yale reserves the right to limit quantities



7000 Series Architectural Exit Devices

2100 SERIES: WIDE STILE FLATBAR



2110 Surface Vertical Rod



2170 Less Bottom Rod

MODEL #	DESCRIPTION	FINISH	HAND	STRIKE	QUICKSHIP #	APPROX. WEIGHT (LBS. EACH)
2110 - SURFACE VERTICAL ROD						
2110-36	SVR Exit Device, 36"	630	RHR	791 Top, 790 Bottom	003276	15
2110-36	SVR Exit Device, 36"	630	LHR	791 Top, 790 Bottom	003279	15
2110-36	SVR Exit Device, 36"	689	RHR	791 Top, 790 Bottom	003283	15
2110-36	SVR Exit Device, 36"	689	LHR	791 Top, 790 Bottom	003284	15
2110-42	SVR Exit Device, 42"	630	RHR	791 Top, 790 Bottom	017387	15
2110-42	SVR Exit Device, 42"	630	LHR	791 Top, 790 Bottom	021626	15
2110-42	SVR Exit Device, 42"	689	RHR	791 Top, 790 Bottom	017665	15
2110-42	SVR Exit Device, 42"	689	LHR	791 Top, 790 Bottom	021627	15
2110-48	SVR Exit Device, 48"	630	RHR	791 Top, 790 Bottom	017388	15
2110-48	SVR Exit Device, 48"	630	LHR	791 Top, 790 Bottom	021628	15
2110-48	SVR Exit Device, 48"	689	RHR	791 Top, 790 Bottom	021629	15
2110-48	SVR Exit Device, 48"	689	LHR	791 Top, 790 Bottom	021630	15
2110F-36	3 Hour Fire Rated SVR Exit Device, 36"	630	RHR	791 Top, 790 Bottom	003274	15
2110F-36	3 Hour Fire Rated SVR Exit Device, 36"	630	LHR	791 Top, 790 Bottom	003275	15
2110F-36	3 Hour Fire Rated SVR Exit Device, 36"	689	RHR	791 Top, 790 Bottom	003290	15
2110F-36	3 Hour Fire Rated SVR Exit Device, 36"	689	LHR	791 Top, 790 Bottom	003291	15
2110F-42	3 Hour Fire Rated SVR Exit Device, 42"	630	RHR	791 Top, 790 Bottom	021631	15
2110F-42	3 Hour Fire Rated SVR Exit Device, 42"	630	LHR	791 Top, 790 Bottom	021632	15
2110F-42	3 Hour Fire Rated SVR Exit Device, 42"	689	RHR	791 Top, 790 Bottom	017671	15
2110F-42	3 Hour Fire Rated SVR Exit Device, 42"	689	LHR	791 Top, 790 Bottom	021633	15
2110F-48	3 Hour Fire Rated SVR Exit Device, 48"	630	RHR	791 Top, 790 Bottom	017525	15
2110F-48	3 Hour Fire Rated SVR Exit Device, 48"	630	LHR	791 Top, 790 Bottom	021634	15
2110F-48	3 Hour Fire Rated SVR Exit Device, 48"	689	RHR	791 Top, 790 Bottom	017673	15
2110F-48	3 Hour Fire Rated SVR Exit Device, 48"	689	LHR	791 Top, 790 Bottom	021635	15
2170 - SURFACE VERTICAL ROD - LBR						
2170F90LBR	90 Min. Fire Rated SVR Exit Device, Less Bottom Rod, 36"	630	—	726	021636	14
2170F90LBR	90 Min. Fire Rated SVR Exit Device, Less Bottom Rod, 36"	689	—	726	021637	14

Note: Yale reserves the right to limit quantities



1800 Series Flatbar Exit Device

1800 SERIES: WIDE STILE FLATBAR



1800 Rim



1810 Surface Vertical Rod

MODEL #	DESCRIPTION	FINISH	HAND	STRIKE	QUICKSHIP #	APPROX. WEIGHT (LBS. EACH)
1800 - RIM						
1800-36	Rim Exit Device, 36"	689	—	757F	017368	11
1800-36	Rim Exit Device, 36"	695	—	757F	017532	11
1800-42	Rim Exit Device, 42"	689	—	757F	017370	12
1800-42	Rim Exit Device, 42"	695	—	757F	017534	12
1800-48	Rim Exit Device, 48"	689	—	757F	017372	12
1800-48	Rim Exit Device, 48"	695	—	757F	017536	12
1800F-36	3 Hour Fire Rated Rim Exit Device, 36"	689	—	757F	017374	11
1800F-36	3 Hour Fire Rated Rim Exit Device, 36"	695	—	757F	017538	11
1800F-42	3 Hour Fire Rated Rim Exit Device, 42"	689	—	757F	017376	12
1800F-42	3 Hour Fire Rated Rim Exit Device, 42"	695	—	757F	017540	12
1800F-48	3 Hour Fire Rated Rim Exit Device, 48"	689	—	757F	017378	12
1800F-48	3 Hour Fire Rated Rim Exit Device, 48"	695	—	757F	017542	12
1810 - SURFACE VERTICAL ROD						
1810-36	SVR Exit Device, 36"	689	RHR	791 Top, 790 Bottom	017369	15
1810-36	SVR Exit Device, 36"	689	LHR	791 Top, 790 Bottom	021638	15
1810-36	SVR Exit Device, 36"	695	RHR	791 Top, 790 Bottom	017533	15
1810-36	SVR Exit Device, 36"	695	LHR	791 Top, 790 Bottom	021639	15
1810-42	SVR Exit Device, 42"	689	RHR	791 Top, 790 Bottom	017371	16
1810-42	SVR Exit Device, 42"	689	LHR	791 Top, 790 Bottom	021640	16
1810-42	SVR Exit Device, 42"	695	RHR	791 Top, 790 Bottom	017535	16
1810-42	SVR Exit Device, 42"	695	LHR	791 Top, 790 Bottom	021641	16
1810-48	SVR Exit Device, 48"	689	RHR	791 Top, 790 Bottom	017373	16
1810-48	SVR Exit Device, 48"	689	LHR	791 Top, 790 Bottom	021642	16
1810-48	SVR Exit Device, 48"	695	RHR	791 Top, 790 Bottom	017537	16
1810-48	SVR Exit Device, 48"	695	LHR	791 Top, 790 Bottom	021643	16

Note: Yale reserves the right to limit quantities



1800 Series Flatbar Exit Device

1800 SERIES: WIDE STILE FLATBAR



1800 Rim



1810 Surface Vertical Rod

MODEL #	DESCRIPTION	FINISH	HAND	STRIKE	QUICKSHIP #	APPROX. WEIGHT (LBS. EACH)
1810F-36	3 Hour Fire Rated SVR Exit Device, 36"	689	RHR	791 Top, 790 Bottom	017375	15
1810F-36	3 Hour Fire Rated SVR Exit Device, 36"	689	LHR	791 Top, 790 Bottom	021644	15
1810F-36	3 Hour Fire Rated SVR Exit Device, 36"	695	RHR	791 Top, 790 Bottom	017539	15
1810F-36	3 Hour Fire Rated SVR Exit Device, 36"	695	LHR	791 Top, 790 Bottom	021645	15
1810F-42	3 Hour Fire Rated SVR Exit Device, 42"	689	RHR	791 Top, 790 Bottom	017377	16
1810F-42	3 Hour Fire Rated SVR Exit Device, 42"	689	LHR	791 Top, 790 Bottom	021646	16
1810F-42	3 Hour Fire Rated SVR Exit Device, 42"	695	RHR	791 Top, 790 Bottom	017541	16
1810F-42	3 Hour Fire Rated SVR Exit Device, 42"	695	LHR	791 Top, 790 Bottom	021647	16
1810F-48	3 Hour Fire Rated SVR Exit Device, 48"	689	RHR	791 Top, 790 Bottom	017379	16
1810F-48	3 Hour Fire Rated SVR Exit Device, 48"	689	LHR	791 Top, 790 Bottom	021648	16
1810F-48	3 Hour Fire Rated SVR Exit Device, 48"	695	RHR	791 Top, 790 Bottom	017543	16
1810F-48	3 Hour Fire Rated SVR Exit Device, 48"	695	LHR	791 Top, 790 Bottom	021649	16

Note: Yale reserves the right to limit quantities



Exit Device Trim

210F SERIES: PLATE TRIM



MODEL #	FINISH	CYLINDER	QUICKSHIP #	APPROX. WEIGHT (LBS. EACH)
NIGHTLATCH ACCESS BY KEY				
213F	689	Less Cylinder	017505	1
213F	695	Less Cylinder	017635	1
DUMMY TRIM PULL PLATE				
214F	689	—	017424	1
214F	695	—	017554	1
NIGHTLATCH CYLINDER X PULL				
217F	689	Less Cylinder	001345	1
217F	695	Less Cylinder	017636	1

Note: See page 65 for cylinder options
Yale reserves the right to limit quantities
The following chart indicates the cylinder finishes used with trims

TRIM FINISH	CYLINDER FINISH
689	626
695	613



Exit Device Trim

440F SERIES: ROSE TRIM



Augusta - AU



Pacific Beach - PB

DESIGN	MODEL #	FINISH	CYLINDER	QUICKSHIP #	APPROX. WEIGHT (LBS. EACH)
NIGHTLATCH ACCESS BY KEY					
AU	441F	626	1802, 6-Pin, PARA Keyed Random	017389	2.5
AU	441F	626	2802, 6-Pin, Schlage® C Keyed Random	017401	2.5
AU	441F	689	1802, 6-Pin, PARA Keyed Random	017437	2.5
AU	441F	689	2802, 6-Pin, Schlage® C Keyed Random	017473	2.5
AU	441F	695	1802, 6-Pin, PARA Keyed Random	017567	2.5
AU	441F	695	2802, 6-Pin, Schlage® C Keyed Random	017603	2.5
PB	441F	626	1802, 6-Pin, PARA Keyed Random	017395	2.5
PB	441F	626	2802, 6-Pin, Schlage® C Keyed Random	017407	2.5
PB	441F	689	1802, 6-Pin, PARA Keyed Random	017440	2.5
PB	441F	689	2802, 6-Pin, Schlage® C Keyed Random	017476	2.5
PB	441F	695	1802, 6-Pin, PARA Keyed Random	017570	2.5
PB	441F	695	2802, 6-Pin, Schlage® C Keyed Random	017606	2.5
NIGHTLATCH ACCESS BY KEY (SMALL FORMAT INTERCHANGEABLE CORE)					
BAU	441F	626	Less Core	017773	2.5
BAU	441F	689	Less Core	017783	2.5
BAU	441F	695	Less Core	017801	2.5
BPB	441F	626	Less Core	017776	2.5
BPB	441F	689	Less Core	017786	2.5
BPB	441F	695	Less Core	017804	2.5
CLASSROOM					
AU	446F	626	1802, 6-Pin, PARA Keyed Random	017391	2.5
AU	446F	626	2802, 6-Pin, Schlage® C Keyed Random	017403	2.5
AU	446F	689	1802, 6-Pin, PARA Keyed Random	017442	2.5
AU	446F	689	2802, 6-Pin, Schlage® C Keyed Random	017478	2.5
AU	446F	695	1802, 6-Pin, PARA Keyed Random	017572	2.5
AU	446F	695	2802, 6-Pin, Schlage® C Keyed Random	017608	2.5
PB	446F	626	1802, 6-Pin, PARA Keyed Random	017397	2.5
PB	446F	626	2802, 6-Pin, Schlage® C Keyed Random	017409	2.5
PB	446F	689	1802, 6-Pin, PARA Keyed Random	017444	2.5
PB	446F	689	2802, 6-Pin, Schlage® C Keyed Random	017480	2.5
PB	446F	695	1802, 6-Pin, PARA Keyed Random	017574	2.5
PB	446F	695	2802, 6-Pin, Schlage® C Keyed Random	017610	2.5

Note: Yale reserves the right to limit quantities



Exit Device Trim

440F SERIES: ROSE TRIM



Augusta - AU



Pacific Beach - PB

DESIGN	MODEL #	FINISH	CYLINDER	QUICKSHIP #	APPROX. WEIGHT (LBS. EACH)
CLASSROOM (SMALL FORMAT INTERCHANGEABLE CORE)					
BAU	446F	626	Less Core	017774	2.5
BAU	446F	689	Less Core	017788	2.5
BAU	446F	695	Less Core	017806	2.5
BPB	446F	626	Less Core	017777	2.5
BPB	446F	689	Less Core	017790	2.5
BPB	446F	695	Less Core	017808	2.5
PASSAGE/DUMMY FREE-WHEELING LEVER					
AU	448F	626	—	017419	2.5
AU	448F	689	—	017427	2.5
AU	448F	695	—	017557	2.5
PB	448F	626	—	017421	2.5
PB	448F	689	—	017431	2.5
PB	448F	695	—	017561	2.5
DUMMY RIGID LEVER					
AU	449F	626	—	017420	2.5
AU	449F	689	—	017428	2.5
AU	449F	695	—	017558	2.5
PB	449F	626	—	017422	2.5
PB	449F	689	—	017432	2.5
PB	449F	695	—	017562	2.5

Note: Yale reserves the right to limit quantities



Exit Device Trim

540F SERIES: ROSE TRIM



Augusta - AU



Pacific Beach - PB

DESIGN	MODEL #	FINISH	CYLINDER	QUICKSHIP #	APPROX. WEIGHT (LBS. EACH)
NIGHTLATCH ACCESS BY KEY					
AU	541F	626	1802, 6-Pin, PARA Keyed Random	003850	2
AU	541F	626	2802, 6-Pin, Schlage® C Keyed Random	021667	2
AU	541F	689	1802, 6-Pin, PARA Keyed Random	021668	2
AU	541F	689	2802, 6-Pin, Schlage® C Keyed Random	021669	2
PB	541F	626	1802, 6-Pin, PARA Keyed Random	021670	2
PB	541F	626	2802, 6-Pin, Schlage® C Keyed Random	021671	2
PB	541F	689	1802, 6-Pin, PARA Keyed Random	021672	2
PB	541F	689	2802, 6-Pin, Schlage® C Keyed Random	021673	2
NIGHTLATCH ACCESS BY KEY (SMALL FORMAT INTERCHANGEABLE CORE)					
BAU	541F	626	Less Core	021674	2
BAU	541F	689	Less Core	021675	2
BPB	541F	626	Less Core	021676	2
BPB	541F	689	Less Core	021677	2
CLASSROOM					
AU	546F	626	1802, 6-Pin, PARA Keyed Random	003809	3
AU	546F	626	2802, 6-Pin, Schlage® C Keyed Random	021678	3
AU	546F	689	1802, 6-Pin, PARA Keyed Random	003936	3
AU	546F	689	2802, 6-Pin, Schlage® C Keyed Random	021679	3
PB	546F	626	1802, 6-Pin, PARA Keyed Random	021680	3
PB	546F	626	2802, 6-Pin, Schlage® C Keyed Random	021681	3
PB	546F	689	1802, 6-Pin, PARA Keyed Random	021682	3
PB	546F	689	2802, 6-Pin, Schlage® C Keyed Random	021683	3
CLASSROOM (SMALL FORMAT INTERCHANGEABLE CORE)					
BAU	546F	626	Less Core	021684	3
BAU	546F	689	Less Core	021685	3
BPB	546F	626	Less Core	021686	3
BPB	546F	689	Less Core	021687	3

Note: Yale reserves the right to limit quantities



Exit Device Trim

540F SERIES: ROSE TRIM



Augusta - AU



Pacific Beach - PB

DESIGN	MODEL #	FINISH	QUICKSHIP #	APPROX. WEIGHT (LBS. EACH)
PASSAGE/DUMMY FREE-WHEELING LEVER				
AU	548F	626	003858	2
AU	548F	689	021688	2
PB	548F	626	021689	2
PB	548F	689	021690	2
DUMMY RIGID LEVER				
AU	549F	626	021691	2
AU	549F	689	021692	2
PB	549F	626	021693	2
PB	549F	689	021694	2

Note: Yale reserves the right to limit quantities



Exit Device Trim

420F SERIES: ESCUTCHEON TRIM



DESIGN	MODEL #	FINISH	HAND	CYLINDER	QUICKSHIP #	APPROX. WEIGHT (LBS. EACH)
EXIT ONLY/BLANK PLATE						
—	420F	630	—	—	021792	2
—	420F	689	—	—	017423	2
—	420F	695	—	—	017553	2
NIGHTLATCH						
—	421F	630	—	Less Cylinder	021650	2.2
—	421F	689	—	Less Cylinder	017507	2.2
—	421F	695	—	Less Cylinder	017637	2.2
CLASSROOM/STOREROOM						
AU	426F	630	RHR	Less Cylinder	021651	2.7
AU	426F	630	LHR	Less Cylinder	021652	2.7
AU	426F	689	RHR	Less Cylinder	017513	2.7
AU	426F	689	LHR	Less Cylinder	017465	2.7
AU	426F	695	RHR	Less Cylinder	017643	2.7
AU	426F	695	LHR	Less Cylinder	017597	2.7
PB	426F	630	RHR	Less Cylinder	021653	2.7
PB	426F	630	LHR	Less Cylinder	021654	2.7
PB	426F	689	RHR	Less Cylinder	017515	2.7
PB	426F	689	LHR	Less Cylinder	017466	2.7
PB	426F	695	RHR	Less Cylinder	017645	2.7
PB	426F	695	LHR	Less Cylinder	017598	2.7
NIGHTLATCH X LEVER						
AU	427F	630	RHR	Less Cylinder	021655	2.7
AU	427F	630	LHR	Less Cylinder	021656	2.7
AU	427F	689	RHR	Less Cylinder	017508	2.7
AU	427F	689	LHR	Less Cylinder	017793	2.7
AU	427F	695	RHR	Less Cylinder	017638	2.7
AU	427F	695	LHR	Less Cylinder	017657	2.7
PB	427F	630	RHR	Less Cylinder	021657	2.7
PB	427F	630	LHR	Less Cylinder	021658	2.7
PB	427F	689	RHR	Less Cylinder	017511	2.7
PB	427F	689	LHR	Less Cylinder	017794	2.7
PB	427F	695	RHR	Less Cylinder	017641	2.7
PB	427F	695	LHR	Less Cylinder	017658	2.7

Note: See page 65 for cylinder options
The following chart indicates the cylinder finishes used with trims
Yale reserves the right to limit quantities

TRIM FINISH	CYLINDER FINISH
630	626
689	626
695	613



Exit Device Trim

420F SERIES: ESCUTCHEON TRIM



DESIGN	MODEL #	FINISH	HAND	CYLINDER	QUICKSHIP #	APPROX. WEIGHT (LBS. EACH)
PASSAGE/DUMMY						
AU	428F	630	RHR	—	021659	2.7
AU	428F	630	LHR	—	021660	2.7
AU	428F	689	RHR	—	017425	2.7
AU	428F	689	LHR	—	017661	2.7
AU	428F	695	RHR	—	017555	2.7
AU	428F	695	LHR	—	017675	2.7
PB	428F	630	RHR	—	021661	2.7
PB	428F	630	LHR	—	021662	2.7
PB	428F	689	RHR	—	017429	2.7
PB	428F	689	LHR	—	017674	2.7
PB	428F	695	RHR	—	017559	2.7
PB	428F	695	LHR	—	017676	2.7
DUMMY RIGID LEVER						
AU	429F	630	RHR	—	021663	2.7
AU	429F	630	LHR	—	021664	2.7
AU	429F	689	RHR	—	017426	2.7
AU	429F	689	LHR	—	017677	2.7
AU	429F	695	RHR	—	017556	2.7
AU	429F	695	LHR	—	017679	2.7
PB	429F	630	RHR	—	021665	2.7
PB	429F	630	LHR	—	021666	2.7
PB	429F	689	RHR	—	017430	2.7
PB	429F	689	LHR	—	017678	2.7
PB	429F	695	RHR	—	017560	2.7
PB	429F	695	LHR	—	017680	2.7

Note: See page 65 for cylinder options
The following chart indicates the cylinder finishes used with trims
Yale reserves the right to limit quantities

TRIM FINISH	CYLINDER FINISH
630	626
689	626
695	613



Exit Device Trim

620F SERIES: ESCUTCHEON TRIM



DESIGN	MODEL #	FINISH	HAND	CYLINDER	QUICKSHIP #	APPROX. WEIGHT (LBS. EACH)
EXIT ONLY/BLANK PLATE						
—	620F	626	—	—	021695	2
—	620F	630	—	—	021696	2
NIGHTLATCH						
—	621F	626	—	Less Cylinder	021697	2.5
—	621F	630	—	Less Cylinder	021793	2.5
CLASSROOM/STOREROOM						
AU	626F	626	RHR	Less Cylinder	002336	5
AU	626F	626	LHR	Less Cylinder	002337	5
AU	626F	630	RHR	Less Cylinder	001328	5
AU	626F	630	LHR	Less Cylinder	001329	5
CR	626F	626	RHR	Less Cylinder	002340	5
CR	626F	626	LHR	Less Cylinder	002341	5
CR	626F	630	RHR	Less Cylinder	002370	5
CR	626F	630	LHR	Less Cylinder	002373	5
PB	626F	626	RHR	Less Cylinder	002344	5
PB	626F	626	LHR	Less Cylinder	002345	5
PB	626F	630	RHR	Less Cylinder	001374	5
PB	626F	630	LHR	Less Cylinder	001375	5
NIGHTLATCH X LEVER						
AU	627F	626	RHR	Less Cylinder	021698	5
AU	627F	626	LHR	Less Cylinder	021699	5
AU	627F	630	RHR	Less Cylinder	021700	5
AU	627F	630	LHR	Less Cylinder	021701	5
CR	627F	626	RHR	Less Cylinder	021702	5
CR	627F	626	LHR	Less Cylinder	021703	5
CR	627F	630	RHR	Less Cylinder	021704	5
CR	627F	630	LHR	Less Cylinder	021705	5
PB	627F	626	RHR	Less Cylinder	021706	5
PB	627F	626	LHR	Less Cylinder	021707	5
PB	627F	630	RHR	Less Cylinder	021708	5
PB	627F	630	LHR	Less Cylinder	021709	5

**Note: See page 65 for cylinder options
Yale reserves the right to limit quantities**



Exit Device Trim

620F SERIES: ESCUTCHEON TRIM



DESIGN	MODEL #	FINISH	HAND	QUICKSHIP #	APPROX. WEIGHT (LBS. EACH)
PASSAGE/DUMMY					
AU	628F	626	RHR	002346	5
AU	628F	626	LHR	002347	5
AU	628F	630	RHR	001372	5
AU	628F	630	LHR	001373	5
CR	628F	626	RHR	002348	5
CR	628F	626	LHR	002349	5
CR	628F	630	RHR	002394	5
CR	628F	630	LHR	002395	5
PB	628F	626	RHR	002350	5
PB	628F	626	LHR	002351	5
PB	628F	630	RHR	001376	5
PB	628F	630	LHR	001377	5
DUMMY RIGID LEVER					
AU	629F	626	RHR	002352	5
AU	629F	626	LHR	002353	5
AU	629F	630	RHR	002408	5
AU	629F	630	LHR	002409	5
CR	629F	626	RHR	021710	5
CR	629F	626	LHR	021711	5
CR	629F	630	RHR	021712	5
CR	629F	630	LHR	021713	5
PB	629F	626	RHR	021714	5
PB	629F	626	LHR	021715	5
PB	629F	630	RHR	021716	5
PB	629F	630	LHR	021717	5

Note: Yale reserves the right to limit quantities



Exit Device Trim

620F SERIES: ESCUTCHEON TRIM WITH REFLECTIONS® DECORATIVE LEVERS



TB



TQ



TS



TY

DESIGN	MODEL #	FINISH	HAND	CYLINDER	QUICKSHIP #	APPROX. WEIGHT (LBS. EACH)
CLASSROOM/STOREROOM						
TB	626F	626	RHR	Less Cylinder	021718	6
TB	626F	626	LHR	Less Cylinder	021719	6
TQ	626F	626	RHR	Less Cylinder	021724	6
TQ	626F	626	LHR	Less Cylinder	021725	6
TS	626F	626	RHR	Less Cylinder	021728	6
TS	626F	626	LHR	Less Cylinder	021729	6
TY	626F	626	RHR	Less Cylinder	021732	6
TY	626F	626	LHR	Less Cylinder	021733	6
NIGHTLATCH X LEVER						
TB	627F	626	RHR	Less Cylinder	021734	6
TB	627F	626	LHR	Less Cylinder	021735	6
TQ	627F	626	RHR	Less Cylinder	021740	6
TQ	627F	626	LHR	Less Cylinder	021741	6
TS	627F	626	RHR	Less Cylinder	021744	6
TS	627F	626	LHR	Less Cylinder	021745	6
TY	627F	626	RHR	Less Cylinder	021748	6
TY	627F	626	LHR	Less Cylinder	021749	6
PASSAGE/DUMMY						
TB	628F	626	RHR	—	021750	6
TB	628F	626	LHR	—	021751	6
TQ	628F	626	RHR	—	021756	6
TQ	628F	626	LHR	—	021757	6
TS	628F	626	RHR	—	021760	6
TS	628F	626	LHR	—	021761	6
TY	628F	626	RHR	—	021764	6
TY	628F	626	LHR	—	021765	6
DUMMY RIGID LEVER						
TB	629F	626	RHR	—	021766	6
TB	629F	626	LHR	—	021767	6
TQ	629F	626	RHR	—	021772	6
TQ	629F	626	LHR	—	021773	6
TS	629F	626	RHR	—	021776	6
TS	629F	626	LHR	—	021777	6
TY	629F	626	RHR	—	021780	6
TY	629F	626	LHR	—	021781	6

**Note: Yale reserves the right to limit quantities
See page 65 for cylinder options**



Exit Device Trim

630F SERIES: ESCUTCHEON TRIM



MODEL #	FINISH	CYLINDER	QUICKSHIP #	APPROX. WEIGHT (LBS. EACH)
NIGHTLATCH X PULL				
632F	626	Less Cylinder	002400	5
632F	630	Less Cylinder	002403	5
CLASSROOM/STOREROOM				
633F	626	Less Cylinder	002376	5
633F	630	Less Cylinder	002379	5
DUMMY				
634F	626	—	002410	5
634F	630	—	002411	5

690F SERIES: ELECTRIFIED TRIM



DESIGN	MODEL #	FINISH	HAND	CYLINDER	QUICKSHIP #	APPROX. WEIGHT (LBS. EACH)
FAIL SAFE						
AU	690F	630	RHR	Less Cylinder	001386	6
AU	690F	630	LHR	Less Cylinder	001387	6
FAIL SECURE						
AU	691F	630	RHR	Less Cylinder	001388	6
AU	691F	630	LHR	Less Cylinder	001389	6

**Note: See page 65 for cylinder options
Yale reserves the right to limit quantities**



Removable Mullions

M200 & KRM200 SERIES: REMOVABLE MULLIONS



M200(F) Removable mullion



KRM200(F) Keyed Removable Mullion

MODEL #	DESCRIPTION	CYLINDER	QUICKSHIP #	APPROX. WEIGHT (LBS. EACH)
REMOVEABLE MULLIONS				
FOR 7 FT. OPENINGS				
M200-7	Complete for Panic Exits	—	021782	32
M200F-7	Complete for Fire Exits	—	017548	32
FOR 8 FT. OPENINGS				
M200-8	Complete for Panic Exits	—	003524	37
M200F-8	Complete for Fire Exits	—	003525	37
KEY REMOVEABLE MULLIONS				
FOR 7 FT. OPENINGS				
KRM200-7	Complete for Panic Exits	Less Cylinder	021783	32
KRM200F-7	Complete for Fire Exits	Less Cylinder	017546	32
FOR 8 FT. OPENINGS				
KRM200-8	Complete for Panic Exits	Less Cylinder	021784	37
KRM200F-8	Complete for Fire Exits	Less Cylinder	017547	37
OPTIONS				
M203	Spacer Block - Recommended for: 1) double rabbeted frames where the "stop face" width is less than the mounting hole spacing. 2) 5-3/4" or less doors.	—	021785	0.5
M204	Angle Bracket - Recommended for any header configuration with less than 3" of mounting surface.	—	021786	0.2

Note: Yale reserves the right to limit quantities
See page 65 for cylinder options



Cylinders For Trim And Mullions

CYLINDERS FOR EXIT DEVICE TRIMS AND MULLIONS

MODEL #	DESCRIPTION	KEY SECTION	FINISH	COLLAR SIZE INCLUDED	QUICKSHIP #	APPROX. WEIGHT (LBS. EACH)
RIM CYLINDERS						
1109	6-Pin, Keyed Random	GA	613	1765.250	022032	0.4
1109	6-Pin, 0-Bitted	GA	613	1765.250	022033	0.4
1109	6-Pin, Keyed Random	PARA	613	1765.250	022034	0.4
1109	6-Pin, 0-Bitted	PARA	613	1765.250	022035	0.4
1109	6-Pin, Keyed Random	GA	626	1765.250	002779	0.4
1109	6-Pin, 0-Bitted	GA	626	1765.250	002729	0.4
1109	6-Pin, Keyed Random	PARA	626	1765.250	002778	0.4
1109	6-Pin, 0-Bitted	PARA	626	1765.250	022036	0.4
2109	6-Pin, Schlage® Keyed Random	C	613	1765.250	022037	0.4
2109	6-Pin, Schlage® 0-Bitted	C	613	1765.250	022038	0.4
2109	6-Pin, Schlage® Keyed Random	C	626	1765.250	022039	0.4
2109	6-Pin, Schlage® 0-Bitted	C	626	1765.250	022040	0.4
RIM CYLINDERS (INTERCHANGEABLE CORE)						
1193 x 1-7/16"	LFIC, 6-Pin, 0-Bitted	GA	613	1765.250	022041	1
1193 x 1-7/16"	LFIC, 6-Pin, 0-Bitted	PARA	613	1765.250	022042	1
1193 x 1-7/16"	LFIC, 6-Pin, 0-Bitted	GA	626	1765.250	022043	1
1193 x 1-7/16"	LFIC, 6-Pin, 0-Bitted	PARA	626	1765.250	022044	1
1193 x 1-7/16"	LFIC, 6-Pin, 0-Bitted	GA	613	1765.469	022045	1
1193 x 1-7/16"	LFIC, 6-Pin, 0-Bitted	PARA	613	1765.469	022046	1
1193 x 1-7/16"	LFIC, 6-Pin, 0-Bitted	GA	626	1765.469	010141	1
1193 x 1-7/16"	LFIC, 6-Pin, 0-Bitted	PARA	626	1765.469	022047	1
1193 x 1-7/16"	LFIC, 6-Pin, 0-Bitted	GA	613	1765.656	022048	1
1193 x 1-7/16"	LFIC, 6-Pin, 0-Bitted	PARA	613	1765.656	022049	1
1193 x 1-7/16"	LFIC, 6-Pin, 0-Bitted	GA	626	1765.656	022050	1
1193 x 1-7/16"	LFIC, 6-Pin, 0-Bitted	PARA	626	1765.656	022051	1
RIM HOUSINGS						
1212 x 1-7/16"	LFIC Housing Only, Less Core	—	613	1765.250	022052	0.5
1212 x 1-7/16"	LFIC Housing Only, Less Core	—	626	1765.250	022053	0.5
1212 x 1-7/16"	LFIC Housing Only, Less Core	—	613	1765.469	022054	0.5
1212 x 1-7/16"	LFIC Housing Only, Less Core	—	626	1765.469	001784	0.5
1212 x 1-7/16"	LFIC Housing Only, Less Core	—	613	1765.656	022055	0.5
1212 x 1-7/16"	LFIC Housing Only, Less Core	—	626	1765.656	022056	0.5
K680 x 1-3/8"	SFIC Housing Only, Less Core	—	613	1765.187	022057	0.5
K680 x 1-3/8"	SFIC Housing Only, Less Core	—	626	1765.187	022058	0.5
K680 x 1-3/8"	SFIC Housing Only, Less Core	—	613	1765.375	022059	0.5
K680 x 1-3/8"	SFIC Housing Only, Less Core	—	626	1765.375	022060	0.5
K680 x 1-3/8"	SFIC Housing Only, Less Core	—	613	1765.406	022061	0.5
K680 x 1-3/8"	SFIC Housing Only, Less Core	—	626	1765.406	022062	0.5
K680 x 1-3/8"	SFIC Housing Only, Less Core	—	613	1765.563	022063	0.5
K680 x 1-3/8"	SFIC Housing Only, Less Core	—	626	1765.563	022192	0.5
MORTISE CYLINDERS FOR KRM AND SDA16						
2153 x 1-1/8"	6-Pin, Keyed Random	GA	626	1765.312	022064	0.4
2153 x 1-1/8"	6-Pin, 0-Bitted	GA	626	1765.312	022065	0.4
2153 x 1-1/8"	6-Pin, Keyed Random	PARA	626	1765.312	022066	0.4
2153 x 1-1/8"	6-Pin, 0-Bitted	PARA	626	1765.312	022067	0.4
2553 x 1-1/8"	6-Pin, Schlage® Keyed Random	C	626	1765.312	022068	0.4
2553 x 1-1/8"	6-Pin, Schlage® 0-Bitted	C	626	1765.312	022069	0.4
INTERCHANGEABLE CORES (LARGE FORMAT)						
1210	Core Only, 6-Pin, 0-Bitted	GA	—	626	001783	0.3
1210	Core Only, 6-Pin, 0-Bitted	PARA	—	626	001791	0.3

Note: Yale reserves the right to limit quantities



Exit Device Miscellaneous Hardware

MISCELLANEOUS HARDWARE FOR EXIT DEVICES AND TRIM

MODEL #	DESCRIPTION	FINISH	QUICKSHIP #	APPROX. WEIGHT (LBS. EACH)
EXTENSION RODS - FOR ALL EXIT DEVICE SERIES				
7010-2	2" (51mm) Length	630	003817	1
7010-6	6" (152mm) Length	630	003818	1
7010-12	12" (305mm) Length	630	003819	1
2010-2	2" (51mm) Length	689	003980	1
2010-6	6" (152mm) Length	689	003981	1
2010-12	12" (305mm) Length	689	003982	1
2010-2	2" (51mm) Length	695	021787	1
2010-6	6" (152mm) Length	695	021788	1
2010-12	12" (305mm) Length	695	021789	1
SHIM KITS				
723	For Rim, SquareBolt®, CVR and Mortise Devices	693	003599	2
724	For SVR Devices	693	003601	3
STRIKES				
790	Standard Floor Strike	693	003566	0.1
791	Standard Top Strike	693	003565	0.1
793	Optional Rim Strike for Double Door Applications without a Mullion	—	003567	1.5
SLEEVE NUT PACKS				
SN-104	—	626, 630, 689	003682	0.1
SN-134	—	626, 630, 689	002398	0.2
SN-134	—	695	002399	0.2
MISCELLANEOUS				
1109BPK	Backplate Kit for 1109 Rim Cylinders	626	002771	0.5
7000	Long Spindle (Tailpiece) Kit for All 620F & 630F Series Trim, 2" to 2-1/2" Thick Door	—	003955	0.1
ECK1	Flush End Cap Kit	630	021790	1
ECK7	Impact Resistant End Cap Kit	630	003612	1
60-7000-0815	Schlage® Cam and Housing Assembly	—	022432	0.5
1765.250	Cylinder Collar	626	001611	0.1
1765.312	Cylinder Collar	626	022073	0.1
1765.656	Cylinder Collar	626	001610	0.1
KP4	Cylinder Collar	626	001612	0.1
ELECTRIFIED OPTIONS				
BPS-24-1	1 AMP Power Supply	—	003450	9
BPS-24-2	2 AMP Power Supply	—	003451	15
BPS-24-4	4 AMP Power Supply	—	003452	22
7116	Alarm Kit for 7000 Series Exit Devices	630	003541	2
SDA16-1	Stand-Alone Door Alarm, Less Cylinder	—	021791	1.5

Note: Yale reserves the right to limit quantities



Door Closers

5800 SERIES: CAST IRON

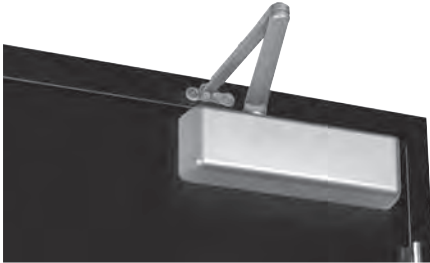

5801

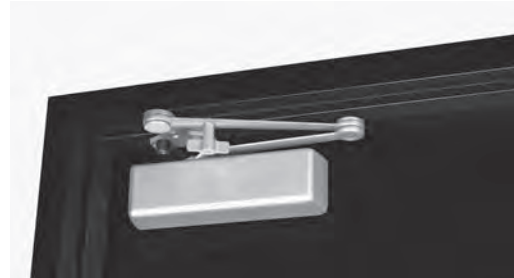

5821T

MODEL #	DESCRIPTION	FINISH	QUICKSHIP #	APPROX. WEIGHT (LBS. EACH)
NON-HOLD OPEN, WITH SLEEVE NUTS				
5801	Multi-Size 1-6	689	015032	12
5801	Multi-Size 1-6	690	015033	12
5801DL	Multi-Size 1-6, Delayed Action	689	015192	12
5801DL	Multi-Size 1-6, Delayed Action	690	015193	12
NON-HOLD OPEN, WITH SLEEVE NUTS				
5821	Stop Only, Multi-Size 1-6	689	015036	14
5821	Stop Only, Multi-Size 1-6	690	015037	14
5831	Stop Only with Spring, Multi-Size 1-6	689	015194	14
5831	Stop Only with Spring, Multi-Size 1-6	690	015195	14
HOLD OPEN, WITH SLEEVE NUTS				
5811	Multi-Size 1-6	689	015034	12
5811	Multi-Size 1-6	690	015035	12
HOLD OPEN, WITH SLEEVE NUTS				
5821T	Holder/Stop Thumbturn, Multi-Size 1-6	689	015038	14
5821T	Holder/Stop Thumbturn, Multi-Size 1-6	690	015039	14
5831T	Holder/Stop Thumbturn with Spring, Multi-Size 1-6	689	015196	14
5831T	Holder/Stop Thumbturn with Spring, Multi-Size 1-6	690	015197	14
ACCESSORIES				
5800COV	Full Plastic Cover	689	015040	0.5
5800COV	Full Plastic Cover	690	015041	0.5
5800SP	Screw Pack	689	015042	0.2
5800SP	Screw Pack	690	015043	0.2
2730KIT	Door Saver Spring Stop	689	015184	0.2
2730KIT	Door Saver Spring Stop	690	015185	0.2
5800RDP	Narrow Frame Drop Plate (Regular Arm)	689	015116	2
5800RDP	Narrow Frame Drop Plate (Regular Arm)	690	015117	2
5800PDP	Narrow Top Rail Drop Plate (Parallel Arm)	689	015118	2
5800PDP	Narrow Top Rail Drop Plate (Parallel Arm)	690	015119	2
SN-134	Sleeve Nut Pkg., 1-3/4" Door	689	002331	0.2
SN-134	Sleeve Nut Pkg., 1-3/4" Door	690	002334	0.2
TBGN134-47	Through-Bolt and Grommet Nut Pkg., 1-3/4" Door	689	007240	0.2
TBGN134-47	Through-Bolt and Grommet Nut Pkg., 1-3/4" Door	690	007264	0.2

Notes:

- Closers tri-packed
- Case quantity = 4
- SN-134 = 4 per pack; supplied standard with all 5800 door closers

- TBGN134-47 = 4 sets per pack
- Yale reserves the right to limit quantities
- For heavy-duty parallel rigid arm applications, specify 5821 or 5821T, stop is removable



Door Closers

4400 SERIES: INSTITUTIONAL



4400



4420

MODEL #	DESCRIPTION	FINISH	QUICKSHIP #	APPROX. WEIGHT (LBS. EACH)
NON-HOLD OPEN, SLEEVE NUTS NOT INCLUDED				
4400	Multi-Size 1-6	689	002087	9
CLOSERS PACKED WITH SLEEVE NUTS				
4400 x SN	Multi-Size 1-6	689	002086	9
HOLDER/STOP, NON-HOLD OPEN				
4420	Multi-Size	689	002095	14
ACCESSORIES				
SN-134	Sleeve Nut Pkg., 1-3/4" Door	689	002331	0.2
TBGN134-47	Through-Bolt and Grommet Nut Pkg., 1-3/4" Door	689	007240	0.2

Notes:

- Closers tri-packed
- Case quantity = 4
- SN-134 = 4 per pack
- TBGN134-47 = 4 sets per pack
- Yale reserves the right to limit quantities



Door Closers

3000 SERIES: ARCHITECTURAL



3301 - SLIM LINE COVER



3501 - FULL COVER



3521T

MODEL #	DESCRIPTION	FINISH	QUICKSHIP #	APPROX. WEIGHT (LBS. EACH)
3300 - SLIM LINE COVER				
NON-HOLD OPEN, SLEEVE NUTS NOT INCLUDED				
3301	Multi-Size 1-6	689	005079	7
3301	Multi-Size 1-6	690	005080	7
3500 - FULL COVER				
NON-HOLD OPEN, SLEEVE NUTS NOT INCLUDED				
3501	Multi-Size 1-6	689	005083	8
3501	Multi-Size 1-6	690	005084	8
HOLDER/STOP, NON-HOLD OPEN WITH SLEEVE NUTS				
3521 x SN	Multi-Size	689	002126	9
HOLDER/STOP, HOLD OPEN WITH SLEEVE NUTS				
3521T x SN	Multi-Size x Thumbturn	689	002128	9
CLOSERS PACKED WITH SLEEVE NUTS				
3301 x SN	Multi-Size 1-6, Slim Line Cover	689	005174	7
3501 x SN	Multi-Size 1-6, Full Cover	689	005207	7
CLOSER BODY ONLY				
3101LAP	3300/3500	689	005086	10
ACCESSORIES				
SN-134	Sleeve Nut Pkg., 1-3/4" Door	689	002331	0.2
SN-134	Sleeve Nut Pkg., 1-3/4" Door	690	002334	0.2
TBGN134-38	Through-Bolt and Grommet Nut Pkg., 1-3/4" Door	689	007228	0.2
TBGN134-38	Through-Bolt and Grommet Nut Pkg., 1-3/4" Door	690	002300	0.2

Notes:

- Closers tri-packed
- Case quantity = 4
- SN-134 = 4 per pack
- TBGN134-38 = 4 sets per pack
- Yale reserves the right to limit quantities



Door Closers

2700 SERIES: ARCHITECTURAL



2701



2721T

MODEL #	DESCRIPTION	FINISH	QUICKSHIP #	APPROX. WEIGHT (LBS. EACH)
NON-HOLD OPEN, WITH SLEEVE NUTS				
2701	Multi-Size 1-6	689	015014	6.5
2701	Multi-Size 1-6	690	015015	6.5
2701DL	Multi-Size 1-6, Delayed Action	689	015190	6.5
2701DL	Multi-Size 1-6, Delayed Action	690	015191	6.5
NON-HOLD OPEN, WITH SLEEVE NUTS				
2721	Stop Only, Multi-Size 1-6	689	015020	7.75
2721	Stop Only, Multi-Size 1-6	690	015021	7.75
2731	Stop Only with Spring, Multi-Size 1-6	689	015186	7.75
2731	Stop Only with Spring, Multi-Size 1-6	690	015187	7.75
HOLD OPEN, WITH SLEEVE NUTS				
2711	Multi-Size 1-6	689	015016	6.5
2711	Multi-Size 1-6	690	015017	6.5
HOLD OPEN, WITH SLEEVE NUTS				
2721T	Holder/Stop Thumbturn, Multi-Size 1-6	689	015022	7.75
2721T	Holder/Stop Thumbturn, Multi-Size 1-6	690	015023	7.75
2731T	Holder/Stop Thumbturn with Spring, Multi-Size 1-6	689	015188	7.75
2731T	Holder/Stop Thumbturn with Spring, Multi-Size 1-6	690	015189	7.75
ACCESSORIES				
2700COV	Full Plastic Cover	689	015024	0.5
2700COV	Full Plastic Cover	690	015025	0.5
2730KIT	Door Saver Spring Stop	689	015184	0.2
2730KIT	Door Saver Spring Stop	690	015185	0.2
2700SP	Screw Pack	689	015026	0.2
2700SP	Screw Pack	690	015027	0.2
SN-134	Sleeve Nut Pkg., 1-3/4" Door	689	002331	0.2
SN-134	Sleeve Nut Pkg., 1-3/4" Door	690	002334	0.2
TBGN134-38	Through-Bolt and Grommet Nut Pkg., 1-3/4" Door	689	007228	0.2
TBGN134-38	Through-Bolt and Grommet Nut Pkg., 1-3/4" Door	690	002300	0.2

Notes:

- Closers tri-packed
- Case quantity 2701 = 6
- Case quantity 2711, 2721, 2721T = 4
- SN-134 = 4 per pack; supplied standard with all 2700 door closers
- TBGN134-38 = 4 sets per pack
- Yale reserves the right to limit quantities
- For heavy-duty parallel rigid arm applications, specify 2721 or 2721T, stop is removable



Door Closers

51 SERIES: INDUSTRIAL



MODEL #	DESCRIPTION	FINISH	QUICKSHIP #	APPROX. WEIGHT (LBS. EACH)
NON-HOLD OPEN				
51BF	Multi-Size 1-4, Barrier Free	689	008390	7
51BF	Multi-Size 1-4, Barrier Free	690	008391	7
51	Multi-Size 3-6	689	008395	7
51	Multi-Size 3-6	690	008396	7
ACCESSORIES				
SN-134	Sleeve Nut Pkg., 1-3/4" Door	689	002331	0.2
SN-134	Sleeve Nut Pkg., 1-3/4" Door	690	002334	0.2
TBGN134-38	Through-Bolt and Grommet Nut Pkg., 1-3/4" Door	689	007228	0.2
TBGN134-38	Through-Bolt and Grommet Nut Pkg., 1-3/4" Door	690	002300	0.2

Notes:

- Closers tri-packed
- Case quantity = 6
- SN-134 = 4 per pack
- TBGN134-38 = 4 sets per pack
- Sleeve nuts not included
- Yale reserves the right to limit quantities



Door Closers

1100 SERIES: INDUSTRIAL



MODEL #	DESCRIPTION	FINISH	QUICKSHIP #	APPROX. WEIGHT (LBS. EACH)
NON-HOLD OPEN, WITH SLEEVE NUTS				
1101BF	Multi-Size 1-4	689	017919	6
1101BF	Multi-Size 1-4	690	017923	6
1101BFCOV	Multi-Size 1-4, Cover Included	689	015185	6
1101BFCOV	Multi-Size 1-4, Cover Included	690	015183	6
1104BC	Size 4 with Backcheck	689	017917	6
1104BC	Size 4 with Backcheck	690	017918	6
HOLD OPEN, WITH SLEEVE NUTS				
1111BF	Multi-Size 1-4	689	017921	8
1111BF	Multi-Size 1-4	690	017922	8
ACCESSORIES				
1100COV	Optional Cover for 1100 Series	689	017933	0.5
1100COV	Optional Cover for 1100 Series	690	017934	0.5
SN-134	Sleeve Nut Pkg., 1-3/4" Door	689	002331	0.2
SN-134	Sleeve Nut Pkg., 1-3/4" Door	690	002334	0.2
TBGN134-38	Through-Bolt and Grommet Nut Pkg., 1-3/4" Door	689	007228	0.2
TBGN134-38	Through-Bolt and Grommet Nut Pkg., 1-3/4" Door	690	002300	0.2

Notes:

- Closers tri-packed
- Case quantity 1101BF, 1104BC = 6
- Case quantity 1111BF = 4
- SN-134 = 4 per pack; supplied standard with all 1100 door closers
- TBGN134-38 = 4 sets per pack
- Yale reserves the right to limit quantities
- Cover ordered separately



Door Closers

DOOR CLOSER ACCESSORIES

CLOSER TOUCH-UP PAINT				
MODEL #	DESCRIPTION	FINISH	QUICKSHIP #	APPROX. WEIGHT (LBS. EACH)
1A	Aluminum	689	007781	1
5S*	Dark Bronze	690	007786	1
2B	Light Bronze	691	007787	1
6SB	Satin Brass (Gold)	696	007788	1

Spray paint to match closers manufactured:
*after November 2002.

OPTIONAL FASTENERS				
MODEL #	DESCRIPTION	FINISH	QUICKSHIP #	APPROX. WEIGHT (LBS. EACH)
SNB134-38	Sleeve Nut w/ Screws (3000, 2700, 51, 1100)	689	004900	1

Note: SNB134-38 - 4 sets per pack



Order Form

FAX TO: 800-338-0965 OR E-MAIL TO: ORDERS@ASSAABLOYDSS-CS.COM
ATTENTION: CUSTOMER SERVICE

Account # _____ P.O. # _____ P.O. Date _____

Buying Program **Quote Number (or fax copy of quote submitted with this form)** _____

Company Name _____

Contact Name _____

Contact Phone _____ Contact Fax _____ Contact E-mail _____

Ship To _____

Address _____

City _____ State _____ Zip _____

Attention _____

-
- Ship Via:** Standard: Ground
 Next Day: Freight Pre-Paid and Added to Customer Invoice
 2nd Day: Freight Pre-Paid and Added to Customer Invoice

Special Markings: _____

Instructions:

1. Orders should be submitted on this form to qualify for QuickShip.
2. Factory lead times apply if ANY items on the order are NOT listed in the current published QuickShip offering.
3. Orders can not be changed or cancelled.

Qty.	QuickShip #	Description	Comments	Price



Order Form

FAX TO: 800-338-0965 OR E-MAIL TO: ORDERS@ASSAABLOYDSS-CS.COM
ATTENTION: CUSTOMER SERVICE

Account # _____ P.O. # _____ Page _____ of _____

Instructions:

1. Orders should be submitted on this form to qualify for QuickShip.
2. Factory lead times apply if ANY items on the order are NOT listed in the current published QuickShip offering.
3. Orders can not be changed or cancelled.

Qty.	QuickShip #	Description	Comments	Price

Contact Us

The world's favorite lock



U.S.A.

Yale Locks & Hardware

Address: 225 Episcopal Road
Berlin, CT 06037-4004
Tel: 1-800-438-1951
Fax: 1-800-338-0965
yalelocks.com

Canada:

ASSA ABLOY Door Security Solutions Canada

Address: 160 Four Valley Drive
Vaughan, Ontario L4K 4T9
Tel: 1-800-461-3007
Fax: 1-800-461-8989
assaabloydss.ca

International:

ASSA ABLOY Americas International

Tel: 1-905-821-7775
Fax: 1-905-821-1429
assaabloyai.com

Yale Locks & Hardware is a division of Yale Security Inc., an ASSA ABLOY Group company.

Copyright © 2002-2020, Yale Security, Inc., an ASSA ABLOY Group company. All rights reserved. Reproduction in whole or in part without the express written permission of Yale Security, Inc. is prohibited. Patent pending and/or patent www.assaabloydss.com/patents.

YALE, with its unique global reach and range of products, is the world's favorite lock.

ASSA ABLOY is the global leader in door opening solutions, dedicated to satisfying end-user needs for security, safety and convenience.

42024-4/20



Trusted every day

Phone

1-855-557-5078

Customer Service Email

customerservice.yale@assaabloy.com

Technical Product Support Email

techsupport.yale@assaabloy.com

Order Entry Email

orders.yaleus@assaabloy.com

Fax

1-800-338-0965

Website

www.yalecommercial.com

Contact Us

U.S.A.

Yale Locks & Hardware

Address: 225 Episcopal Road

Berlin, CT 06037-4004

Tel: 1-800-438-1951

Fax: 1-800-338-0965

yalecommercial.com

Canada:

ASSA ABLOY Door Security Solutions Canada

Address: 160 Four Valley Drive

Vaughan, Ontario L4K 4T9

Tel: 1-800-461-3007

Fax: 1-800-461-8989

assaabloydss.ca

International:

ASSA ABLOY Americas International

Tel: 1-905-821-7775

Fax: 1-905-821-1429

assaabloyai.com

MicroShield®

As part of their promise to provide innovative solutions to their customers, certain ASSA ABLOY Group brands offer the MicroShield® technology, a silver-based antimicrobial coating designed to inhibit the growth of bacteria.

Microshield® is a registered trademark of ASSA ABLOY Access and Egress Hardware Group, Inc.



The Agion antimicrobial is not intended as a substitute for good hygiene. Coated products must still be cleaned to ensure the surfaces will be free of destructive microbes. ASSA ABLOY makes no representations or warranties, express or implied, as to the efficacy of the Agion antimicrobial. A copy of the Agion warranty is available upon request. Agion is a registered trademark of Agion Technologies, Inc., Wakefield, MA, USA.

THE YALE BRAND, with its unparalleled global reach and range of products, reassures more people in more countries than any other consumer locking solution.

THE ASSA ABLOY GROUP is the world's leading manufacturer and supplier of locking solutions, dedicated to satisfying end-user needs for security, safety and convenience.

Yale Commercial is a business associated with ASSA ABLOY Access and Egress Hardware Group, Inc., an ASSA ABLOY Group company. Copyright © 1999-2021, ASSA ABLOY Access and Egress Hardware Group, Inc. All rights reserved. Reproduction in whole or in part without the express written permission of ASSA ABLOY Access and Egress Hardware Group, Inc. is prohibited. Patent pending and/or patent www.assaabloydss.com/patents.