

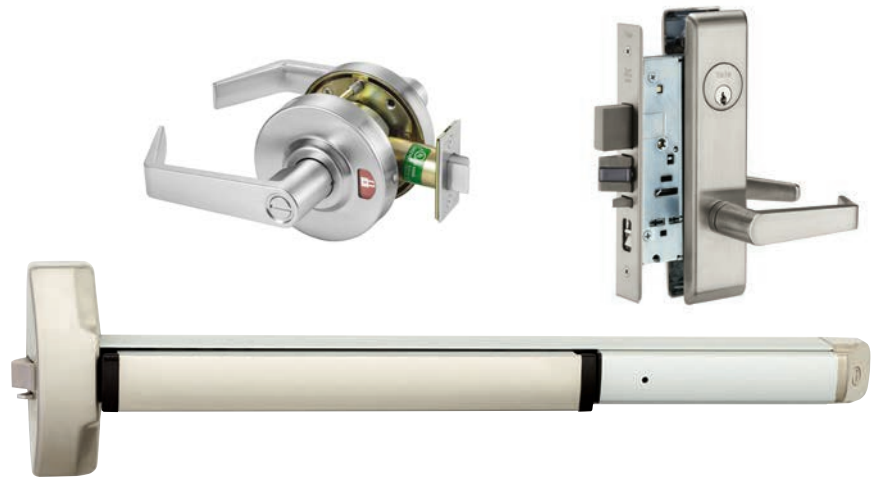

# Condensed Catalog



**ACCENTRA**  
**ASSA ABLOY**

This product is now proudly being offered under the ASSA ABLOY ACCENTRA™ brand, effective June 20, 2023.  
Visit [YaleCommercial.com/en/Today](https://www.yalecommercial.com/en/Today) for support and information.

# Introduction



Yale Locks & Hardware, an ASSA ABLOY Group company based in Berlin, CT, has provided dependable security since 1840. A leading manufacturer in the industry, Yale offers a broad line of door hardware developed for commercial, retail, office buildings, and mixed-use facilities as well as a wide variety of residential options. Our products include mortise and cylindrical locks, exit devices, decorative hardware, door closers, electromechanical products and key systems, as well as solutions for windstorm, multi-family and small business.

When you need an affordable, reliable solution for your facility, Yale Works for You<sup>SM</sup>.

For further information, contact your Door Security Solutions sales representative, call 800-438-1951 or visit us at [www.yalecommercial.com](http://www.yalecommercial.com).

## Americans With Disabilities Act (ADA)

Title III of the Americans With Disabilities Act (ADA), Public Law 101-336, went into effect on January 28, 1992. The ADA "prohibits discrimination on the basis of disability by private entities in places of public accommodation and that the commercial facilities be designed and constructed so as to be readily accessible to and usable by persons with disabilities..." (Federal Register, Vol. 56, No. 144/7-26-91/Rules and Regulations).

Yale locksets and door controls that comply with ADA requirements are indicated as such by the accessibility symbol in this catalog.

## Contents

Introduction.....	2
Reflections® Decorative Levers.....	3
Mortise Locksets .....	4
Mortise Lock Trim.....	5-6
Mortise Lock Status Indicators .....	7
Cylindrical Locksets .....	8-13
RL Series Tubular Locks .....	14
Monolocks.....	15
Auxiliary Locks.....	16
Lockset Functions.....	17-22
Exit Devices.....	23-25
Exit Device Functions .....	26
Exit Device Trim .....	27-28
Cylinders and Keying/Security Cylinders .....	29
Door Controls.....	30-33
Electrified Products.....	34-36
NexTouch® Keypad Locks .....	37-39

## MicroShield®

Yale locks and exit devices are available with MicroShield antimicrobial coating. MicroShield is a revolutionary hardware finish coating, using a silver ion based technology, which inhibits the growth of bacteria, algae, yeast, fungus, mold and mildew. MicroShield is non-toxic and lasts for the lifetime of the finish to which it is applied. To order, suffix option code "YMS".

Note: MicroShield coating may vary finish color from architectural standards. Locksets and exit devices available with MicroShield will be indicated as such by the MicroShield icon. MicroShield is not intended as a substitute for traditional infection control programs such as hand hygiene or use of disinfectants. Coated products must still be cleaned to ensure the surfaces will be free of destructive microbes. Yale makes no representations or warranties, express or implied, as to the efficacy of MicroShield.

# Reflections® Decorative Trim



For more than 150 years, Yale has distinguished itself as an innovative manufacturer and designer of locksets and door hardware. That tradition continues with Reflections® by Yale®, a comprehensive line of highly stylized door levers and coordinating hardware. This premier product series is available for Yale® 8800RL mortise locks, RL tubular locks and exit device trim, creating a continuity of beautiful design throughout a building.

Reflections consists of 36 dynamic and distinctive levers. Each captures a unique beauty and spirit of design unlike any other. These exquisite levers offer Yale quality and exceptional elegance to a variety of high-end commercial projects, including office buildings, museums, upscale hotels and resorts, and large multi-use projects such as apartment and condominium complexes.

Let Reflections® by Yale® inspire your vision of great design.



Hudson	Spree	Seine	Thames	Victoria	Niagara
TB 	RS 	TG* 	TM 	TT* 	CH* 
UB 	RT 	TO* 	TN 	TU* 	DW 
TC 	RU 	TJ* 	TP 	TV* 	MA* 
TD 	RV 	TK* 	TR 	TW* 	RA* 
UC 		TE 	TS 	UW* 	RB* 
		TI 	TQ 	UX* 	RC* 
				TY* 	
				TZ* 	

\*Indicates levers that are handed.

Note: The following Reflections levers are not available in 629 or 630 finish: Victoria TT, TU, TV, TW, TX, TY, UW, UX, TZ; Seine TG, TJ, TK, TO; Danube TE, TI; Hudson TD. Please consider the 618 or 619 finish as an alternative. Reflections levers are not available with knurling option.

# Mortise Locksets



## 8800 Series Mortise Locksets

Yale 8800 Series Mortise Locks are designed and manufactured for uncompromising strength and durability in a range of commercial applications. Lock installation is made easy with quick lever handing, field reversible latchbolt and standard nonhanded strike. The 8800 Series Mortise Lock offers a new measure of security, featuring a reinforced stainless steel deadbolt, heavy-duty, vandal-resistant trim and ANSI/BHMA Grade 1 certification for long life and durability. The 8800 Series Mortise Lock is even backed by a 10 year mechanical warranty, making this product completely worry-free. See pages 34-36 for information on electrified options.



## Features

**ANSI/BHMA:** A156.13, Series 1000 Grade 1 

**UL/cUL:** UL/cUL fire-rated up to 3 hours

**Windstorm:** Certified (refer to local codes)  Hurricane

**Lock Case and Cover:** Heavy-gauge wrought steel, zinc-plated, dichromated

**Backset:** 2-3/4" only

**Deadbolt:** Stainless steel, 1" throw

**Latchbolt:** 3/4" throw, stainless steel one-piece anti-friction

**Guardbolt:** Non-handed. Deadlocks latchbolt when door is closed

**Armor Front:** 8" x 1-1/4"

**Rabbeted Doors:** Non-handed for 1/2" rabbet

**Lead Shielding:** Available to order

**Cylinders:** Brass, 6-pin, keyed-random cylinder with two keys furnished standard, 7-pin available to order. For other cylinder and keying options see page 29.

**Reversibility:** Locksets are handed and offer quick field reversibility

**Strikes:** 1-1/4" Non-handed curved lip standard; other curved lip and flat available to order

**Finishes:** Available in 14 standard finishes

**Warranty:** 10-year mechanical

## Heavy-Duty Escutcheon Trim

8800 Series locks with escutcheon trim are provided standard with the Camden (CN) escutcheon. This zinc die cast escutcheon features one-piece casting for superior strength.

Locks with this escutcheon are ANSI/BHMA certified operational and security Grade 1 and will retrofit to existing Yale escutcheon preps. The aesthetics of the CN escutcheon provide a design continuum with Yale exit device trim for a consistent look throughout the facility.

















# Mortise Lock Trim



## 8800FL Series Standard Lever Trim



All through-bolted



Arcadia*		Augusta	
			
ARR	AR x CN	AUR	AU x CN
Carmel		Jefferson	
			
CRR	CR x CN	JNR	JN x CN
Monroe		Pacific Beach	
			
MOR	MO x CN	PBR	PB x CN
Pinehurst		Virginia	
			
PNR	PN x CN	VIR	VI x CN

\* Indicates levers that are handed.

## 8800 Series Standard Knob Trim Through-bolted



Copenhagen	
	
COR	CO x CN

## 8800FL Designer Trim Through-bolted



Hampton	
	
HAR5	HAE3

## Optional Designer Rose And Escutcheon

R3	E4
	
HAR3	HAE4

# Mortise Lock Trim



## Reflections® Decorative Levers

Yale® 8800RL Mortise Locks are available with Reflections lever trim, a comprehensive line of highly stylized lever handles. Reflections lever handles are made from solid brass or stainless steel and can withstand years of abuse. Available in a multitude of finishes, the levers complement any wood grain or other door exterior. Each lever is hand-polished and specially designed for ergonomics and style.

## Features

- All 8800RL Series lever trims feature through-bolted installation. For sectional trims, this ensures positive alignment of the trim with the lock case.
- All outside trim is held in place by threaded posts. For sectional trims, the posts fit through holes in the lock case and are secured by through-bolts from the inside trim. For escutcheon trims, the posts fit through the door and are secured by through-bolts from the inside trim.
- Outside escutcheon trims have no visible screws - a great deterrent to vandalism.
- 8800RL Mortise Locks feature an internal heavy-duty spring cartridge which prevents lever sag.
- All 8800RL trims are UL/cUL listed for fire door applications.
- Available for 1-3/4" to 3-1/4" thick doors.
- Lever designs are available as shown on page 3.

## Reflections® Roses

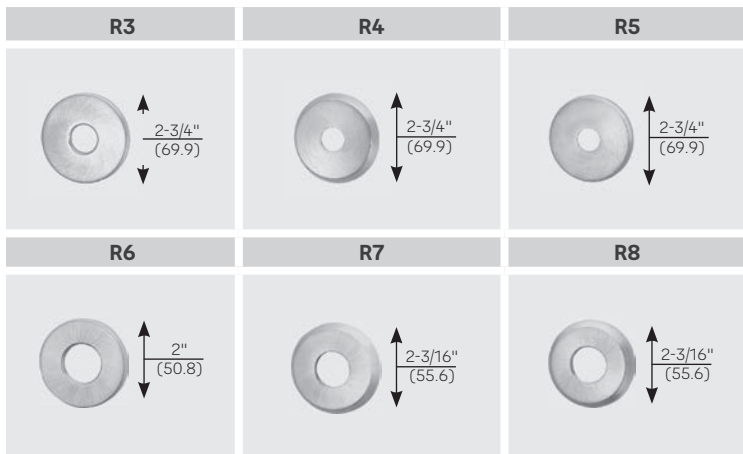

## Reflections® Escutcheons

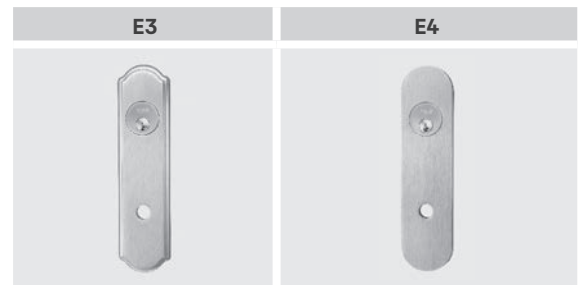



# Mortise Lock Status Indicators

## Applications

8800 Series indicators can be used in a variety of applications and are most commonly used to identify occupancy or display the locked/unlocked status of a room.

- Restrooms
- Quiet rooms
- Nursing mother's rooms
- Classroom doors



## Features

- Inside, outside or both sides of the door
- Sectional or escutcheon trim
- Available with 24 different functions – including thumbturn functions
- Viewing window 25% larger than competition
- Patented curved design for viewing at multiple angles
- Window located prominently above the cylinder
- Highly reflective viewing window for increased safety
- Optional directional engraving available – must specify handing
- Retrofittable for existing applications

## Functions

- Indicators are available with the following 8800 Series functions. See pages 17-22 for details.

8802	8827
8808	8832
8808-2	8840
8809	8847
8811-2	8860
8812-2	8860-2
8814	8861
8814-2	8862
8815	8864
8818-2	8865
8820	8866
8822	8867

# Cylindrical Locksets



## YPL Series Status Indicator Lock

Eliminate potentially embarrassing situations and provide peace of mind with the YPL Series cylindrical lock with status indicator. With a visual display of the occupancy status, the indicator notifies individuals if the door is locked or unlocked, providing an increased level of privacy.



## Features

- ANSI/BHMA:** Certified ANSI/BHMA A156.2 Grade 1 
- UL/cUL:** UL/cUL listed for 3 hour doors
- Backset:** 2-3/4" (70mm) standard, 2-3/8" (60mm) optional
- Latchbolt:** Plain, 2-3/4" (70mm) backset x 1-1/8" (29mm) square corner front with 1/2" (13mm) throw standard, 2-3/8" (60mm) x 1" (25mm) optional
- Door Thickness:** 1-3/4" (44mm) standard, accommodates 1-3/8" (35mm) with adapter plate kit (ordered separately, specify APK-2)
- Reversibility:** Non-handed
- Strikes:** ANSI strike 4-7/8" x 1-1/4" x 1-1/4" (124mm x 32mm x 32mm) lip to center
- Finishes:** Available in 4 finishes
- Warranty:** 3 years

## YPL Series Trim



**Augusta AU**



# Cylindrical Locksets





## 5400LN Series Cylindrical Lever Locksets

Designed for commercial and industrial use, the Yale 5400LN offers no compromise when it comes to reliability and performance. With construction features such as our Free Wheeling lever mechanism, wear-resistant chassis plates, heavy-duty return springs and door thickness adjustment, it's easy to see why the 5400LN is a favorite among those who demand the highest standard of product quality. See pages 33-34 for information on electrified options.



### Features

- ANSI/BHMA:** A156.2, Series 4000 Grade 1 
- UL/cUL:** UL/cUL fire-rated up to 3 hours
- Windstorm:** Certified (refer to local codes)  Hurricane
- Mechanism:** Heavy-gauge steel, zinc-plated, dichromated
- Backset:** 2-3/4" standard; 3-3/4" or 5" extension link available to order
- Latchbolt:** 1/2" stainless steel throw standard; 3/4" throw available to order
- Guardbolt:** Deadlocks latchbolt when door is closed; standard on all locking functions
- Door Thickness:** Adjustable from 1-3/4" to 2". Available to 2-1/4" doors to order.
- Fronts:** 2-1/4" x 1-1/8" beveled standard; flat fronts available to order
- Lead Shielding:** Available to order
- Cylinders:** Brass, 6-pin, keyed-random cylinder with two keys furnished standard, 7-pin available to order. For other cylinder and keying options, see page 29.
- Reversibility:** Non-handed
  - Strikes:** 1-1/4" curved lip for 1-3/4" door standard; other lip lengths available to order; all reversible
  - Finishes:** Available in 10 standard finishes
  - Warranty:** 7-year mechanical

## 5400LN Series Trim



Levers available to accept small format interchangeable cores and large format interchangeable cores from ASSA®, Medeco® and Schlage®. Fixed core cylinders available with keyways from Corbin®, Corbin Russwin®, Russwin®, Sargent® and Schlage®.

# Cylindrical Locksets



## 5400CK Series Cylindrical Knob Locksets

When demanding the highest standard of product performance in even the toughest industrial applications, look no further than the Yale 5400CK Series Heavy-Duty Grade 1 cylindrical locksets. These high-quality key-in-knob locksets offer the finest cylindrical lock mechanisms available and are constructed with high-grade materials for long-lasting reliability. Manufactured for the industrial, commercial and institutional markets, 5400CK Series locksets feature security, dependability and versatility in attractive designs and finishes that fulfill all decorative requirements and blend with any architectural décor.



### Features

- ANSI/BHMA:** A156.2, Series 4000 Grade 1 
- UL/cUL:** UL/cUL fire-rated up to 3 hours
- Mechanism:** Heavy-gauge steel, zinc-plated, dichromated
- Backset:** 2-3/4" standard
- Latchbolt:** 1/2" stainless steel throw standard
- Guardbolt:** Deadlocks latchbolt when door is closed; standard on all locking functions
- Door Thickness:** Adjustable from 1-3/8" to 2" standard; Factory preset to 1-3/4" (44mm). 1-1/4" to 1-3/8" or 2" to 2-1/4" available to order for most trim
- Fronts:** 2-1/4" x 1-1/8" universal
- Cylinders:** Brass, 6-pin, keyed-random cylinder with two keys furnished standard. For other cylinder and keying options, see page 29.
- Reversibility:** Non-handed
- Strikes:** 1-1/4" curved lip ANSI 497 supplied standard, T-Strike optional. All strikes available with optional lip lengths and wrought boxes
- Finishes:** Available in 3 finishes
- Warranty:** 10-year mechanical

## 5400CK Series Trim



Carolina CA

# Cylindrical Locksets





## 5300LN Series Cylindrical Lever Locksets

This revolutionary lockset boasts features such as a vandal-resistant Free Wheeling lever mechanism and an adjustable door thickness design that makes installation a breeze. Through-bolting provides a secure fit that resists rattling and shaking. With three lever designs and eleven finishes, you have the freedom and ability to match any decor. See pages 34-36 for electrified information.



### Features

- ANSI/BHMA:** A156.2, Series 4000 Grade 2 
- UL/cUL:** UL/cUL fire-rated up to 3 hours
- Windstorm:** Certified (refer to local codes)  Hurricane
- Mechanism:** Heavy-gauge steel, zinc-plated, dichromated
- Backset:** 2-3/4" standard; 2-3/8", 3-3/4" or 5" extension links available to order
- Latchbolt:** 1/2" stainless steel throw
- Guardbolt:** Deadlocks latchbolt when door is closed; standard on all locking functions
- Door Thickness:** Adjustable from 1-3/4" to 2". Available for 1-3/8" or 2-1/4" doors to order.
- Fronts:** Universal for both flat and beveled door edges
- Lead Shielding:** Not available
- Cylinders:** Brass, 6-pin, keyed-random cylinder with two keys furnished standard, 7-pin not available. For other cylinder and keying options see page 29.
- Reversibility:** Non-handed
  - Strikes:** 1-1/4" curved lip for 1-3/4" door standard; other lip lengths available to order; all reversible
  - Finishes:** Available in 10 standard finishes
  - Warranty:** 5-year mechanical

## 5300LN Series Trim



Levers available to accept small format interchangeable cores and large format interchangeable cores from ASSA®, Medeco® and Schlage®. Fixed core cylinders available with keyways from Corbin®, Corbin Russwin®, Russwin®, Sargent® and Schlage®.

# Cylindrical Locksets





## 4700LN Series Cylindrical Locksets

Yale® 4700LN cylindrical locks are the ideal choice for a wide variety of commercial applications where consistent quality, ease of use and installation are required at an economical price. The 4700LN series is certified to ANSI/BHMA Grade 1 standards and is UL fire-listed for all functions ensuring reliability and peace of mind. See pages 34-36 for electrified information.



### Features

- ANSI/BHMA:** A156.2, Series 4000 Grade 1 
- UL/cUL:** UL/cUL fire-rated up to 3 hours
- Windstorm:** Certified (refer to local codes)  Hurricane
- Mechanism:** Heavy-gauge steel, die-cast, zinc-plated, chromated
- Backset:** 2-3/4" standard
- Latchbolt:** 1/2" stainless steel throw standard
- Guardbolt:** Deadlocks latchbolt when door is closed; standard on all locking functions
- Door Thickness:** Adjustable from 1-3/4" to 2", available for 1-3/8" or 2-1/4" doors to order.
- Fronts:** 2-1/4" x 1-1/8" beveled standard; flat fronts available to order
- Cylinders:** Brass, 6-pin, keyed-random cylinder with two keys furnished standard, 7-pin not available. For other cylinder and keying options see page 29.
- Reversibility:** Non-handed
- Strikes:** ANSI strike 4-7/8" x 1-1/4" x 1-1/4" lip to center supplied standard. Optional T-strike available to order for 4700LN.
- Finishes:** Available in 9 standard finishes
- Warranty:** 5-year mechanical

## 4700LN Series Trim

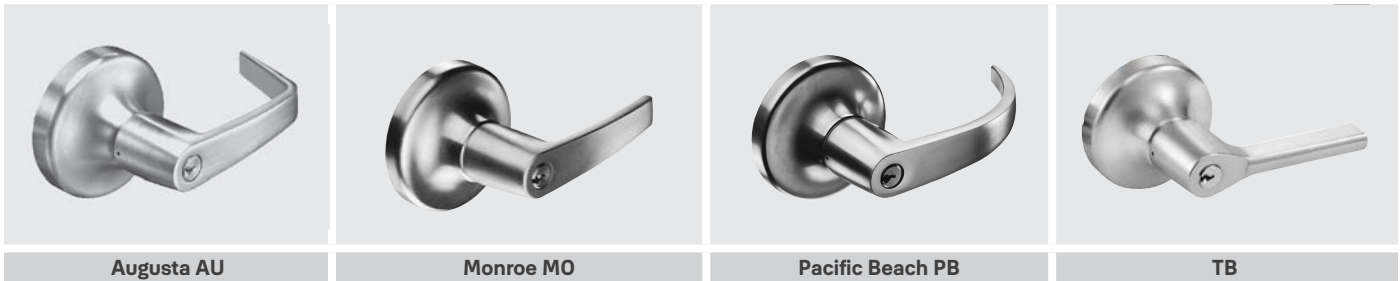

Levers and knob available to accept 6- and 7- pin small format interchangeable cores.  
Fixed core cylinders available with keyways from Corbin®, Corbin Russwin®, Russwin®, Sargent® and Schlage®.

# Cylindrical Locksets





## 4600LN and 4600YC Series Cylindrical Locksets

Yale® 4600LN and 4600YC cylindrical locks are the ideal choice for a wide variety of commercial applications where consistent quality, ease of use and installation are required at an economical price. These series are certified to ANSI/BHMA Grade 2 standards and is UL fire-listed for all functions ensuring reliability and peace of mind. 4600LN cylindrical lever locks are supplied with optional through-bolts. Installation of through-bolts is at the discretion of the installer.



### Features

- ANSI/BHMA:** A156.2, Series 4000 Grade 2 
- UL/cUL:** UL/cUL fire rated up to 3 hours
- Windstorm:** 4600LN Certified (refer to local codes)  Hurricane
- Mechanism:** Heavy-gauge steel, zinc plated, dichromated
- Backset:** 2-3/4" standard; 2-3/8" to order
- Latchbolt:** 1/2" stainless steel throw
- Guardbolt:** Deadlocks latchbolt when door is closed; standard on all locking functions
- Door Thickness:** Adjustable from 1-3/8" to 1-3/4"
- Fronts:** Universal for both flat and beveled door edges
- Cylinders:** Brass, 6-pin, keyed-random cylinder with two keys furnished standard, 7-pin not available. For other cylinder and keying options see page 29.
- Reversibility:** Non-handed
- Strikes:** 1-1/4" curved lip for 1-3/4" door standard; other lip lengths to special order; all reversible
- Finishes:** 4600LN available in 6 finishes; 4600YC available in 5 finishes
- Warranty:** 3-year mechanical

### 4600YC Series Trim

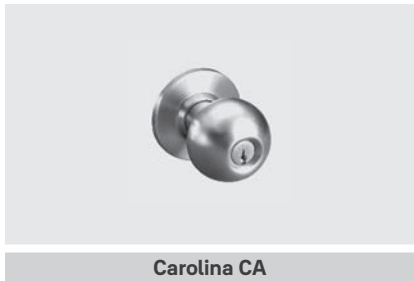

Levers and knob available to accept 6- and 7-pin small format interchangeable cores. Fixed core cylinders available with keyways from Corbin®, Corbin Russwin®, Russwin®, Sargent® and Schlage®.

### 4600LN Series Trim



# RL Series Tubular Locksets



RL Series Tubular Locks are designed to work with Yale® Reflections® decorative levers. Engineered for ease of installation with the quality you expect from Yale, the RL series will meet and exceed the expectations of the most demanding architects and design professionals. Ideal interior applications include hospitality, mixed-use facilities, apartments and condominiums.



## Features

- UL/cUL:** Available UL/cUL fire-rated up to 3 hours
- Backset:** 2-3/4" standard or 2-3/8" available to order
- Latchbolt:** 1/2" brass throw
- Door Thickness:** Adjustable from 1-3/8" to 1-3/4"
- Fronts:** 2-3/4" backset furnished standard with a 1-1/8" wide square corner front. 2-3/8" backset furnished standard with a 1" wide square corner front.
- Reversibility:** Non-handed
- Strikes:** 1-1/4" curved lip T-strike standard; ANSI and full lip strikes available to order
- Finishes:** Available in 13 finishes
- Warranty:** 1-year mechanical

## RL Series Trim

See page 3 for Reflections® decorative levers.

# Monolocks



## 6400LN Series Monolocks

Based on the Yale® 5400LN Grade 1 cylindrical lockset, the 6400LN Monolock continues the tradition of quality and dependability as a preassembled lock series designed to retrofit existing Yale® Monolock as well as Corbin Russwin Unit Lock and Falcon® Retrofit Lock installations with 1-3/4" latch height.



## Features

- UL/cUL:** UL/cUL fire-rated up to 1-1/2 hours
- Mechanism:** Heavy-gauge steel, zinc-plated, dichromated
- Backset:** 2-3/4"
- Latchbolt:** 1/2" stainless steel throw
- Guardbolt:** Deadlocks latchbolt when door is closed; standard on all locking functions
- Door Thickness:** 1-3/4" only
- Lead Shielding:** Available to order
- Cylinders:** Brass, 6-pin, keyed-random cylinder with two keys furnished standard, 7-pin available to order. For other cylinder and keying options, see page 29.
- Reversibility:** Handing must be specified for all functions and designs
  - Strikes:** 1-1/4" lip ANSI strike supplied; other lip lengths and strikes available to order; all reversible
  - Finishes:** Available in 1 finish
  - Warranty:** 7-year mechanical

## 6400LN Series Trim



Levers available to accept small format interchangeable cores and large format interchangeable cores from ASSA®, Medeco® and Schlage®. Fixed core cylinders available with keyways from Corbin®, Corbin Russwin, Russwin®, Sargent® and Schlage®.

# Auxiliary Locks



## D100/D200 Series Cylindrical Deadbolts

- ANSI/BHMA:** D100 = A156.36, Grade 1  
D200 = A156.36, Grade 2 
- UL/cUL:** UL/cUL fire-rated up to and including 3 hours. cUL fire-rated for wood doors up to 90 minutes.
- Backset:** 2-3/4" or 2-3/8" available to order
- Door Preparation:** Can be installed on metal doors prepared to ANSI/BHMA A156.115 Specifications
- Cross Bore Wood Doors:** Standard - 2-1/8" diameter
- Edge Bore:** 1" diameter
- Deadbolt:** 1" throw, solid steel deadbolt with hardened, free spinning, steel pin insert.
- Door Thickness:** 1-3/8" to 1-3/4" standard
- Cylinders:** Brass, 6-pin, keyed-random cylinder with two keys furnished standard. For other cylinder and keying options, see page 29.
- Reversibility:** Non-handed
- Strikes:** 2-3/4" x 1-1/8" metal and wood door strikes with strike reinforcement standard
- Finishes:** Available in 8 standard finishes
- Warranty:** 1-year mechanical



## 350 Series Auxiliary Mortise Deadlock

- UL/cUL:** UL/cUL fire-rated up to and including 3 hours. cUL fire-rated for wood doors up to 90 minutes.
- Case:** Heavy wrought steel, zinc-plated and dichromated
- Backset:** 2-3/4"
- Deadbolt:** Laminated stacked steel with hardened pin, 1" throw.
- Door Thickness:** 1-3/8" to 4" maximum, must be specified
- Front:** Universal for both flat and beveled door edges
- Thumbturn:** Brass, bronze or stainless steel. Thumbturn attaches directly to lock case for added security.
- Cylinder:** Brass, 6-pin, keyed-random cylinder with two keys furnished standard, 7-pin available to order. For other cylinder and keying options, see page 29.
- Reversibility:** Non-handed
- Finishes:** Available in 13 standard finishes
- Warranty:** 1-year mechanical





# Lockset Functions



Function/ Application	(ANSI) Model Nos.	Mortise Locksets	(ANSI) Model Nos.	Cylindrical Knob Locksets	(ANSI) Model Nos.	Cylindrical Lever Locksets/ Monolocks
Passage or Closet Latch	<b>(F01) Knob</b> 8801 <b>Levers</b> 8801FL SL8801FL 8801RL		<b>(F75)</b> 5401CK 4601		<b>(F75)</b> 5401LN 5301LN 4701LN 4601LN 4301LN 6401LN	
Privacy, Bedroom or Bath Lock	<b>(F19) Knob</b> 8802 <b>Levers</b> 8802FL SL8802FL 8802RL		<b>(F76A)</b> 5402CK 4602		<b>(F76A)</b> YPL02 5402LN 5302LN 4702LN 4602LN 4302LN 6402LN	
Patio or Privacy Lock		N/A		N/A	<b>(F77)</b> 5403LN 5303LN 4703LN 6403LN	
Entry Lock		N/A		N/A	<b>(F82A)</b> 5404LN 5304LN 4704LN 4604LN 6404LN	
Storeroom or Closet Lock	<b>(F07) Knob</b> 8805 <b>Levers</b> 8805FL SL8805FL 8805RL		<b>(F86)</b> 5405CK 4605		<b>(F86)</b> 5405LN 5305LN 4705LN 4605LN 4305LN 6405LN	
Service Station Lock		N/A		N/A	<b>(F92)</b> 5406LN 5306LN 4706LN 6406LN	
Entry Lock	<b>(F04) Knob</b> 8807 <b>Levers</b> 8807FL SL8807FL 8807RL		<b>(F109)</b> 5407CK 4707 4607		<b>(F109)</b> 5407LN 5307LN 4707LN 4607LN 4307LN 6407LN	
Classroom Lock	<b>(F05) Knob</b> 8808 <b>Levers</b> 8808FL SL8808FL 8808RL		<b>(F84)</b> 5408CK 4708 4608		<b>(F84)</b> 5408LN 5308LN 4708LN 4608LN 4308LN 6408LN	
Note: Shaded area denotes rigid lever or knob.			Note: Shaded area denotes rigid knob.		Note: Shaded area denotes Free Wheeling lever (except 4300LN and 4600LN).	

Indicator options available for both sectional and escutcheon trim.

# Lockset Functions



Function/ Application	(ANSI) Model Nos.	Mortise Locksets	(ANSI) Model Nos.	Cylindrical Knob Locksets	(ANSI) Model Nos.	Cylindrical Lever Locksets/ Monolocks
<b>Intruder Latchbolt Lock</b>	<b>(F32) Knob</b> 8808-2 <b>Levers</b> 8808-2FL SL8808-2FL 8808-2RL		N/A		N/A	
<b>Classroom or Office Lock (Mortise) Exit Latch (Cylindrical)</b>	<b>Knob</b> 8809 <b>Levers</b> 8809FL SL8809FL 8809RL		N/A		<b>(F89)</b> 5409LN 5309LN 4709LN 6409LN	
<b>Intruder Deadbolt Lock</b>	<b>(F33) Knob</b> 8811-2 <b>Levers</b> 8811-2FL SL8811-2FL 8811-2RL		N/A		N/A	
<b>Intruder Deadbolt Lock</b>	<b>(F34) Knob</b> 8812-2 <b>Levers</b> 8812-2FL SL8812-2FL 8812-2RL		N/A		N/A	
<b>Classroom Deadlock</b>	<b>(F29)</b> 8813ST		N/A		N/A	
<b>Classroom Deadlock</b>	8813ST-2		N/A		N/A	
<b>Deadlock</b>	<b>(F18)</b> 8814		N/A		N/A	
<b>Deadlock</b>	<b>(F16)</b> 8814-2		N/A		N/A	
	<b>Note: Shaded area denotes rigid lever or knob.</b>		<b>Note: Shaded area denotes rigid knob.</b>		<b>Note: Shaded area denotes Free Wheeling lever.</b>	

 Indicator options available for both sectional and escutcheon trim.

# Lockset Functions











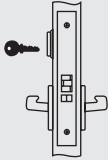

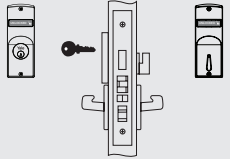
Function/ Application	(ANSI) Model Nos.	Mortise Locksets	(ANSI) Model Nos.	Cylindrical Knob Locksets	(ANSI) Model Nos.	Cylindrical Lever Locksets/ Monlocks
<b>Deadlock</b>	<b>(F17)</b> 8815			N/A		N/A
<b>Apartment, Exit or Public Toilet Lock</b>	<b>(F09)</b> <b>Knob</b> 8817-2 <b>Levers</b> 8817-2FL SL8817-2FL 8817-2RL			N/A	<b>(F88)</b> 5417LN 6417LN	
<b>Classroom Security Intruder Lock</b>	<b>Knob</b> 8818-2 <b>Levers</b> 8818-2FL SL8818-2FL 8818-2RL			N/A	<b>(F110)</b> 5418LN 5318LN 4718LN 6418LN	
<b>Store Door Lock</b>		N/A		N/A		N/A
<b>Hotel Guest Lock</b>	<b>(F15)</b> <b>Knob</b> 8820 <b>Levers</b> 8820FL SL8820FL 8820RL			N/A		N/A
<b>Communicating Lock</b>		N/A		N/A	<b>(F80)</b> 5421LN 5321LN 4721LN 6421LN	
<b>Dormitory, Exit or Corridor Lock</b>	<b>(F13)</b> <b>Knob</b> 8822 <b>Levers</b> 8822FL SL8822FL 8822RL			N/A	<b>(F90)</b> 5422LN 5322LN 4722LN 6422LN	
<b>Storeroom Lock</b>	<b>Knob</b> 8823 <b>Levers</b> 8823FL SL8823FL 8823RL			N/A		N/A
	<b>Note: Shaded area denotes rigid lever or knob.</b>		<b>Note: Shaded area denotes rigid knob.</b>		<b>Note: Shaded area denotes Free Wheeling lever.</b>	

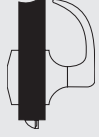
Indicator options available for both sectional and escutcheon trim.

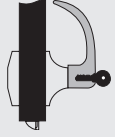
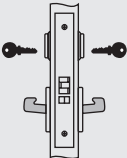
# Lockset Functions

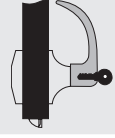

Function/ Application	(ANSI) Model Nos.	Mortise Locksets	(ANSI) Model Nos.	Cylindrical Knob Locksets	(ANSI) Model Nos.	Cylindrical Lever Locksets/ Monolocks
<b>Holdback Lock</b>	<b>Knob</b> 8824 <b>Levers</b> 8824FL SL8824FL 8824RL			N/A		N/A
<b>Privacy Lock</b>		N/A		N/A	5425LN 5325LN 4725LN 6425LN	
<b>Hotel/Motel Lock</b>	<b>Knob</b> 8827 <b>Levers</b> 8827FL SL8827FL 8827RL			N/A		N/A
<b>Exit or Communicating Passage Lock</b>	<b>(F31)</b> <b>Knob</b> 8828 <b>Levers</b> 8828FL SL8828FL 8828RL			N/A	<b>(F111)</b> 5428LN 5328LN 4728LN 4628LN 4328LN 6428LN	
<b>Communicating Classroom or Closet Lock</b>	<b>Knob</b> 8829 <b>Levers</b> 8829FL SL8829FL 8829RL			N/A	<b>(F113)</b> 5429LN 5329LN 4729LN 6429LN	
<b>Asylum or Institutional Lock</b>	<b>(F30)</b> <b>Knob</b> 8830-2 <b>Levers</b> 8830-2FL SL8830-2FL 8830-2RL		<b>(F87)</b>  5430		<b>(F87)</b> 5430LN 5330LN 4730LN 6430LN	
<b>Communicating Storeroom Lock</b>		N/A		N/A	<b>(F112)</b> 5439LN 5339LN 4739LN	
<b>Note: Shaded area denotes rigid lever or knob.</b>			<b>Note: Shaded area denotes rigid knob.</b>		<b>Note: Shaded area denotes Free Wheeling lever.</b>	

 Indicator options available for both sectional and escutcheon trim.

# Lockset Functions



Function/ Application	(ANSI) Model Nos.	Mortise Locksets	Function/ Application	(ANSI) Model Nos.	Mortise Locksets
<b>Detention Lock</b>	<b>Knob</b> 8831 <b>Lever</b> SL8831FL		<b>Apartment Corridor Door Lock</b>	<b>(F20) Knob</b> 8847 <b>Levers</b> 8847FL SL8847FL 8847RL	
<b>Hotel/Motel Lock</b>	<b>Knob</b> 8832 <b>Levers</b> 8832FL SL8832FL 8832RL		<b>Room Door Lock</b>	<b>(F21) Knob</b> 8860 <b>Levers</b> 8860FL SL8860FL 8860RL	
<b>Exit Lock</b>	<b>Knob</b> 8833 <b>Lever</b> 8833FL 8833RL		<b>Store Door Lock</b>	<b>(F14) Knob</b> 8860-2 <b>Levers</b> 8860-2FL SL8860-2FL 8860-2RL	
<b>All Purpose Lock</b>	8833-2		<b>Dormitory or Storeroom Lock</b>	<b>Knob</b> 8861 <b>Levers</b> 8861FL SL8861FL 8861RL	
<b>All Purpose Lock</b>	<b>Knob</b> 8834 <b>Lever</b> 8834FL 8834RL		<b>Privacy, Bedroom or Bath Lock</b>	<b>(F22) Knob</b> 8862 <b>Levers</b> 8862FL SL8862FL 8862RL	
<b>All Purpose Lock</b>	<b>Knob</b> 8834-2 <b>Lever</b> 8834-2FL 8834-2RL		<b>Bathroom Lock with Indicator</b>	<b>Knob</b> 8864 <b>Levers</b> 8864FL 8864RL	
<b>Exit Lock</b>	<b>Knob</b> 8835 <b>Lever</b> 8835FL SL8835FL 8835RL		<b>Bathroom Lock</b>	<b>Knob</b> 8865 <b>Levers</b> 8865FL SL8865FL 8865RL	
<b>Storeroom Deadbolt</b>	<b>Knob</b> 8840 <b>Levers</b> 8840FL SL8840FL 8840RL		<b>Passage Lock with Indicator</b>	<b>Knob</b> 8866 <b>Levers</b> 8866FL 8866RL	
<b>Note: Shaded area denotes rigid lever or knob.</b>			<b>Dormitory or Exit Lock</b>	<b>(F12) Knob</b> 8867 <b>Levers</b> 8867FL SL8867FL 8867RL	
<b>Note: Shaded area denotes rigid lever or knob.</b>					

Indicator options available for both sectional and escutcheon trim.

# Lockset Functions



Function/Application	ANSI (Grade 1/Grade 2)	Model Number	Deadlocks
<b>Mortise Deadlocks</b>			
<b>Cylinder x Thumbturn</b> Deadbolt operated by key outside, thumbturn inside.	—	352	
<b>Cylinder x Cylinder</b> Deadbolt operated by key outside, key inside.	—	351	
<b>Cylinder x Blank (Rose)</b> Deadbolt operated by key outside only. No inside operation.	—	353	
<b>Blank Plate x Thumbturn</b> Deadbolt operated by thumbturn inside only. No outside operation.	—	354	
<b>Cylinder x Classroom Thumbturn</b> Deadbolt operated by key outside, deadbolt retracted by thumbturn inside. Thumbturn will not project deadbolt.	—	357	
<b>Cylinder x Cylinder &amp; Thumbturn</b> Deadbolt by key outside and inside. Inside thumbturn will retract deadbolt but will not project it.	—	356	

Function/Application	ANSI (Grade 1/Grade 2)	Model Number		Deadbolts
		D100	D200	
<b>Cylindrical Deadbolts</b>				
<b>Cylinder x Thumbturn</b> Deadbolt operated by key outside, thumbturn inside.	E0151/E0152	D111 D112 B-D171 B-D172	D211 D212	
<b>Cylinder x Cylinder</b> Deadbolt operated by key outside, key inside.	E0141/E0142	D121 D122	D221 D222	
<b>Cylinder x Blank (Rose)</b> Deadbolt operated by key outside only. No inside operation.	E0161/E0162	D131 D132	D231 D232	
<b>Blank Plate x Thumbturn</b> Deadbolt operated by thumbturn inside only. No outside operation.	E0191/E0192	D141 D142	D241 D242	
<b>Blank Plate x Cylinder</b> Deadbolt operated by key inside only. No outside operation.	E0101/E0102	D151 D152	D251 D252	
<b>Cylinder x Classroom Thumbturn</b> Deadbolt operated by key outside, deadbolt retracted by thumbturn inside. Thumbturn will not project deadbolt.	E0171/E0172	D161 D162 B-D181 B-D182	D261 D262	
<b>Indicator x Thumbturn</b> Deadbolt operated by thumbturn inside, emergency override key outside. Indicator standard for both sides of door, specify indicator option code.	NA/E01112	N/A	D291 D292	

### Deadbolt Model Number Description

D	X	X	X
Model Number	Grade	Function	Backset "1" = 2-3/8", "2" = 2-3/4"



# Exit Devices

## 7000 Series Architectural Exit Devices

Yale® 7000 Series Exit Devices deliver an unparalleled combination of durability, breadth of line, innovation and aesthetics. With an architecturally inspired design that features simple clean lines, both our wide and narrow stile devices are visually appealing and bring gracious totality to the entire line of Yale locks and hardware.



Available with Motorized Electric Latch Retraction. Delivering a quiet, smooth operation for convenient, hassle-free egress using 86% less power consumption during retraction than solenoid devices.



## 7100 Series Exit Devices

A conventional exit device used for single swing doors or pairs of doors of metal, wood or composite construction.

### Types

- Rim SquareBolt® Devices (type 28)
- Rim Pullman Bolt Devices (type 1)
- Surface Vertical Rod Devices (type 2)
- Concealed Vertical Rod Devices (types 7 and 8)
- Mortise Devices (type 3)

### Features

- Certified ANSI/BHMA A156.3 Grade 1 exit hardware 
- UL/cUL listed for fire labeled or panic exit doors
- Windstorm certified (refer to local codes)  Hurricane
- Outside trim fits stock 161 door preps, escutcheon outside fitting stock 86 door preps
- Surface and concealed vertical rod devices are available in Less Bottom Rod varieties
- Double cylinder devices are available for Rim SquareBolt, Rim Pullman and Mortise varieties
- Available with complete range of electrified options, including REX, electric dogging, outside trim monitoring, latch pullback, bolt status monitoring or delayed egress
- Available in 16 standard finishes
- 5-year mechanical warranty





## 7200/7200M Series Exit Devices

The 7200M(F) rim exit device provides the appearance of a narrow stile rim exit device for use on wide stile or flush doors. Using the 7200M(F) with narrow stile trim provides design continuity and pleasing aesthetics when matching exit devices for inside doors to outside narrow stile doors.

### Types

- Rim SquareBolt Devices (type 28)
- Rim Pullman Bolt Devices (type 4)
- Surface Vertical Rod Devices (type 5)
- Concealed Vertical Rod Devices (types 6 and 8)

### Features

- Certified ANSI/BHMA A156.3 Grade 1 exit hardware 
- UL/cUL listed for fire labeled (7200M) or panic exit doors
- Windstorm certified (refer to local codes)  Hurricane
- Optional removable mullions, keyed removable mullions, raised molding clearance kits and custom specialties are all available
- Available with complete range of electrified options, including REX, electric dogging, outside trim monitoring, latch pullback, bolt status monitoring or delayed egress
- Available in 16 standard finishes
- 5-year mechanical warranty





## 6000 Series Commercial Exit Device

With a full range of functions and options and ANSI Grade 1 certification, the Yale® 6000 Series Exit Devices provide the right security for your commercial facility.

### Types

- Rim SquareBolt® Devices (type 5)
- Rim Pullman Bolt Devices (type 0)
- Surface Vertical Rod Devices (type 7)
- Concealed Vertical Rod Devices (type 6)
- Mortise Devices (type 3)



6100-A-ALR emergency exit device features red screenprinted pushpad. See 6000 Series catalog for more information.

### Features

- ANSI/BHMA A156.3 Grade 1 certified 
- UL/cUL listed for fired rated or panic doors
- Available in 13 mechanical functions
- Available in standard or decorative lever designs
- Available in 7 standard finishes
- 10 year warranty





## 2100 Series Flatbar Exit Devices

It's no secret that the 2100 Series Flatbar Exit Device has a reputation as the right choice for meeting the rigors of demanding industry segments.

### Types

- Rim SquareBolt® Devices (type 28)
- Rim Pullman Bolt Devices (type 1)
- Surface Vertical Rod Devices (type 2)
- Concealed Vertical Rod Devices (types 7 and 8)

### Features

- Certified ANSI/BHMA A156.3  Grade 1 exit hardware
- UL/cUL listed for fire labeled or panic exit doors
- Windstorm certified (refer to  Hurricane local codes)
- Optional removable mullions, keyed removable mullions, Torx® security screws and custom specialties are all available
- Available in 8 finishes
- 3-year mechanical warranty







# Exit Devices

## 1800 Series Flatbar Exit Devices

1800 Series Exit Devices are the ideal choice for a wide variety of commercial applications where consistent quality, ease of use and installation are required.

### Types

- Rim Pullman Bolt Devices (type 1)
- Surface Vertical Rod Devices (type 2)

### Features

- Certified ANSI/BHMA A156.3 **BHMA CERTIFIED**  
Grade 1 exit hardware
- UL/cUL listed for fire labeled or panic exit doors
- Outside trim fits stock 161 door preps, escutcheon outside fitting stock 86 door preps
- Available in 8 finishes
- 3-year mechanical warranty

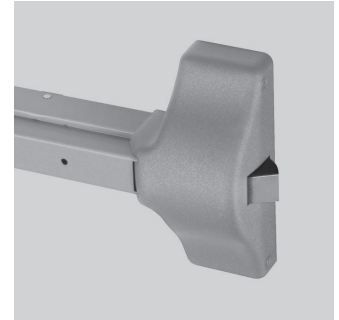

## 1500 Series Traditional Exit Devices

Traditional exit devices for compliance with the exit and access demands of today's codes, where it is important to maintain the architectural lines of yesterday.

### Types

- Rim Pullman Bolt Devices (type 1)
- Surface Vertical Rod Devices (type 2)
- Concealed Vertical Rod Devices (type 8)
- Mortise Devices (type 3)









### Features

- Certified ANSI/BHMA A156.3 **BHMA CERTIFIED**  
Grade 1 exit hardware
- UL listed for fire labeled or panic exit doors
- Mortise devices available with fail safe or fail secure options
- Outside trim options available for most functions
- Optional removable mullions, keyed removable mullions, Torx® security screws and custom specialties are all available
- Available in 15 standard finishes
- 1-year mechanical warranty



# Exit Device Functions



Series	Application	Rim Pullman Bolt	Rim SquareBolt®	Surface Vertical Rod	Concealed Vertical Rod		Mortise
					Metal Doors	Wood Doors	
7100	 Flush or Wide Stile Doors	<b>Panic:</b> 7100 7100-2 <b>Fire:</b> 7100F 7100F-2	<b>Panic:</b> 7150 7150-2 7150WS <b>Fire:</b> 7150F 7150F-2 7150FWS	<b>Panic:</b> 7110 7170* 7170WS <b>Fire:</b> 7110F 7170F* 7170WS	<b>Panic:</b> 7120 7160* <b>Fire:</b> 7120F 7160F*	<b>Panic:</b> 7160* <b>Fire:</b> 7160F*	<b>Panic:</b> 7130 7130-2 <b>Fire:</b> 7130F 7130F-2
7200	 Narrow Stile Doors	<b>Panic:</b> 7200	<b>Panic:</b> 7250	<b>Panic:</b> 7210	<b>Panic:</b> 7220	—	—
7200M	 Flush or Wide Stile Doors	<b>Panic:</b> 7200M <b>Fire:</b> 7200MF	<b>Panic:</b> 7250M 7250MWS <b>Fire:</b> 7250MF 7250MFWS	<b>Panic:</b> 7210M <b>Fire:</b> 7210MF	<b>Panic:</b> 7220M <b>Fire:</b> 7220MF	—	—
6100	 Wide Stile Doors	<b>Panic:</b> 6100-2 <b>Fire:</b> 6100F-2	<b>Panic:</b> 6150 6150-2 6150WS <b>Fire:</b> 6150F 6150F-2 6150FWS	<b>Panic:</b> 6170* 6170WS <b>Fire:</b> 6170F* 6170WS	<b>Panic:</b> 6160* <b>Fire:</b> 6160F*	<b>Panic:</b> 6160* <b>Fire:</b> 6160F*	<b>Panic:</b> 6130 6130-2 <b>Fire:</b> 6130F 6130F-2
6200	 Narrow Stile Doors	<b>Panic:</b> 6200	<b>Panic:</b> 6250	<b>Panic:</b> 6210	<b>Panic:</b> 6220	—	—
2100	 Flush or Wide Stile Doors	<b>Panic:</b> 2100 2100WS <b>Fire:</b> 2100F 2100FWS	<b>Panic:</b> 2150 2150WS <b>Fire:</b> 2150F 2150FWS	<b>Panic:</b> 2110 2170* <b>Fire:</b> 2110F 2170F*	<b>Panic:</b> 2120 2160* <b>Fire:</b> 2120F 2160F*	<b>Panic:</b> 2160* <b>Fire:</b> 2160F*	—
1800	 Flush or Wide Stile Doors	<b>Panic:</b> 1800 <b>Fire:</b> 1800F	—	<b>Panic:</b> 1810 <b>Fire:</b> 1810F	—	—	—
1500	 Flush or Wide Stile Doors	<b>Panic:</b> 1500 <b>Fire:</b> 1500F	—	<b>Panic:</b> 1510 <b>Fire:</b> 1510F	<b>Panic:</b> 1520 <b>Fire:</b> 1520F	—	<b>Panic:</b> 1530 <b>Fire:</b> 1530F

\*Less Bottom Rod (LBR) option available (F90).



# Exit Device Trim

**Entry functions**, for doors equipped with Yale® exit devices, are provided by trim with mechanisms mortised into the doors, and exposed components in architectural finishes. Yale keying systems, as well as other keying, are easily integrated.

**Cylinders:** Brass, 6-pin, keyed-random cylinder with two keys furnished standard, 7-pin available to order. For other cylinder and keying options, see page 29.













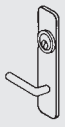





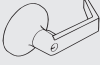

**ADA compliance** is maintained when Yale® exit devices are used with lever handle or pull trims.

**Warranty:** 5-year mechanical for all 600 series trims.



**Vandal-Resistant Free Wheeling** lever action offers protection against forced entry, lockouts, and damage to the hardware.

**Options** include outside cylinder only and decorative lever handles

Trim Series	Device Series	Trim Functions	Remarks
 500F Narrow Escutcheon	7200 7200M 6200	F02, F03, F08, F09 F11, F12 Passage Blank Plate	 ADA Pull Access  Vandal Resistant Lever Action
 480F 510 Narrow Escutcheon With Pull	7200 7200M 6200	F02, F03, F05, F06 F11, F12, F15, F16 Passage Blank Plate	 ADA Pull Access
 420 (Rim, V.R.) 620F (Rim, V.R.) 650F (Mortise) 350F (Mortise) Full Escutcheon	7100 6100 2100 1800	F02, F03, F08, F09, F14 Passage Blank Plate	 ADA Pull Access  Vandal Resistant Lever Action (Rim V.R. Only)
	1500		
 630F (Rim, V.R.) 660F/670F (Mortise) Full Escutcheon	7100 6100 2100 1500	F02, F03, F05, F06, F15 Passage Blank Plate	 ADA Pull Access
 440F 540F 580F Rose	7100 6100 2100 1800	F02, F03, F08, F14 Passage	 ADA Pull Access  Vandal Resistant Lever Action
 210F Plate/Finger Pull	2100	F02, F03	Baked Enamel Finishes
 603F Full Escutcheon with Thumbturn	7100 2100	F08, F09, F14 Passage	Rim, SVR, CVR for use with pull by others
 480F Narrow Escutcheon with Offset Pull	7200 7200M 6200	F02, F03	 ADA Pull Access
 680F Full Escutcheon with Offset Pull	7100	F02, F03	 ADA Pull Access

# Exit Device Trim



## Lever Trim Designs

			
<b>Arcadia AR</b>	<b>Augusta AU</b>	<b>Carmel CR</b>	<b>Jefferson JN</b>
			
<b>Monroe MO</b>	<b>Pacific Beach PB</b>	<b>Pinehurst PN</b>	<b>Virginia VI</b>

## Designer Trim Design



**Hampton HA**

## Reflections® Decorative Levers

See Page 3 For Reflections Decorative Levers.



# Cylinders and Keying/Security Cylinders

## Cylinders And Keying

All Yale® locksets are available in a wide choice of cylinder and keying options:

### Cylinder Types and Options:

- Fixed Core (standard)
- Large Format Interchangeable Core
- Small Format Interchangeable Core
- Conventional Keyways
- Protected Keyways
- Security Cylinders (Not UL437 Certified)
- High Security Cylinders (UL437 Certified)

### Keying Options:

- Keyed Different (KD)
- Keyed Alike (KA)
- Master-Keyed (MK)
- Grand Master-Keyed (GMK)
- Great Grand Master-Keyed (GGMK)
- Construction Keying (CMK)

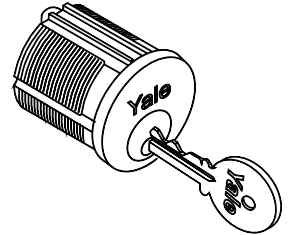

## Interchangeable Cores

Yale® cylinders with interchangeable cores allow your master key systems to be flexible. With the special "Control" key any cylinder can have its core interchanged quickly. Any Yale core can be interchanged into any other Yale lock provided it has a interchangeable core. As a result, security for any given lock can be changed in a matter of minutes. Yale interchangeable core cylinders can be used throughout the entire master key system. They can be used selectively within the system along with Yale fixed core cylinders. There are two types of interchangeable cores that are offered by Yale.

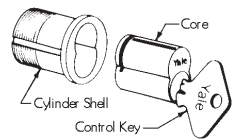

1. Large Format (LFIC) - These cores are available in both standard Yale cylinders and also Yale KeyMark® cylinders. Note that standard Yale cylinders and Yale KeyMark cylinders cannot be keyed to the same master key system.
2. Small Format (SFIC) - Yale offers SFIC cores in Yale KeyMark and Best® keyways A, B, C, D, E, F, G, H, J, K, L and M. Best® keyway cores can be provide keyed random, master keyed or uncombined. Yale will provide master keying to new key system only. Systems can be provided using the A2 or A4 pinning specification and can not be tied into any conventional or Yale KeyMark key systems. All cylindrical lock small format preparations and 1-3/8" housings accept either 6- or 7-pin cores.



## Yale® KeyMark®

For those applications requiring protected key control, Yale® KeyMark® cylinders guard against unauthorized key duplication. The Yale KeyMark Security Leg® keyway feature increases resistance against picking and impressioning and can easily retrofit into existing systems. Cylinders include mortise, rim, key-in-lever, key-in-knob, auxiliary, and interchangeable core. IC core is available in both large and small formats. All formats can be tied into one master key system.



## Security/High Security Cylinders

Yale® security/high-security cylinders contain two independent locking mechanisms. The first is a traditional 6 or 7-pin tumbler mechanism with spool drivers for increased picking resistance.

The second is a 5-tumbler rotating disc mechanism with sidebar engagement. The rotating discs are spring loaded and block the bottom of the keyway. Only a specially cut key will move the discs and allow entrance of the key. This key has a special side biting and must align all five discs perfectly before the cylinder plug will rotate to open the lock.



# Door Controls



## 5800 Series Cast Iron Door Closers

Yale® 5800 Series Cast Iron Door Closers are ideal for commercial applications where ease of use, installation and aesthetics are required at an economical price.

The 5800 Series features rugged construction, adjustments for backcheck, closing and latch speed, rack and pinion operation and a variety of arm options.

### Features

- Adjustable spring sizes 1 through 6
- Non-handed
- Cast iron
- Tri-packed: regular, parallel or top jamb mounting
- Adjustable backcheck valve
- Adjustable closing speed valve
- Adjustable latching speed valve
- Full plastic cover
- Spring power adjustment
- Hold-open and heavy-duty arms arm configurations
- Sleeve nuts included with all models
- Optional - Delayed action
- 10-year limited warranty



### Compliance Standards

- Certified for ANSI/BHMA A156.4 Grade 1 
- UL and cUL listed. This includes compliance to UL10C.
- Meets requirements for Americans with Disabilities Act (ADA) and ANSI/BHMA A117.1 

## 4400 Series Institutional Door Closers

The 4400 Series offers customers the ideal combination of superior performance, quality and strength.

### Features

- Adjustable spring sizes 1 through 6
- Tri-pack standard (regular arm, top jamb and parallel arm mounting)
- Non-handed
- Standard, separate and independent, latch, sweep and backcheck intensity valves
- 2-3/16" (56mm) projection
- Staked valves
- All standard arm applications allow doors to swing 180°, conditions permitting
- 25-year limited warranty

### Optional Features

- Metal cover
- Corrosion-resistant model (specify 4400S)
- Delayed action
- Enhanced backcheck
- Heavy-duty arms available: Regular Rigid, Parallel Rigid, Holder/Stop, Holder/Stop Spring and UNI Stop™
- Slide track – push or pull mounting



### Compliance Standards

- Certified ANSI/BHMA A156.4, Grade 1 
- UL/cUL listed
- UL10C compliant for positive pressure
- Meets requirements for Americans with Disabilities Act (ADA) and ANSI/BHMA A117.1 



# Door Controls

## 3000 Series Architectural Door Closers

The 3000 Series offers the perfect combination of reliability, appearance and durability in today's market.

### Features

- Adjustable spring sizes 1 through 6
- Tri-pack standard (regular arm, top jamb or parallel arm mounting)
- Non-handed
- Staked valves
- Standard, separate and independent, latch, sweep and backcheck intensity valves
- 2-1/8" (54mm) projection (standard covers)
- All standard arm applications allow doors to swing 180°, conditions permitting
- 25-year limited warranty
- Metal, architectural plastic or architectural metal covers
- Delayed action
- Heavy-duty arms available: Parallel Rigid, Holder/Stop, Holder/Stop Spring and UNI Stop™



### Compliance Standards

- Certified ANSI/BHMA A156.4, Grade 1 
- UL/cUL listed
- UL10C compliant for positive pressure
- Meets requirements for Americans with Disabilities Act (ADA) and ANSI/BHMA A117.1 

## 2700 Series Architectural Door Closers

The 2700 Series features rugged construction, adjustments for backcheck, closing and latch speed, and rack and pinion operation.

### Features

- Adjustable spring sizes 1 through 6
- Non-handed
- Aluminum
- Tri-packed: regular, parallel or top jamb mounting
- Adjustable backcheck valve
- Adjustable closing speed valve
- Adjustable latching speed valve
- Full plastic cover
- Spring power adjustment - adjust with adjustable wrench
- Hold-open and heavy-duty arms available
- Sleeve nuts included with all models
- Optional fasteners:
  - Through-bolts and grommet nuts
- Optional - Delayed action
- 10-year limited warranty



### Compliance Standards

- Certified ANSI/BHMA A156.4, Grade 1 
- UL/cUL listed
- UL10C compliant for positive pressure
- Meets requirements for Americans with Disabilities Act (ADA) and ANSI/BHMA A117.1 



## 51 Series Industrial Door Closers

The 51 series is ideal for use with aluminum store front doors and frames, yet they also complement wood or metal door installations.

### Features

- Non-handed
- Staked valves
- Standard, separate and independent, latch, sweep and backcheck intensity valves
- 2-7/8" (73mm) projection
- 15-year limited warranty

### Optional Features

- Delayed action (in lieu of backcheck)
- Molded plastic cover

### Compliance Standards

- Certified ANSI/BHMA A156.4, Grade 1 
- UL/cUL listed
- UL10C compliant for positive pressure
- Meets requirements for Americans with Disabilities Act (ADA) and ANSI/BHMA A117.1 (51BF) 



	51	51BF
Adjustable spring sizes 3 through 6	X	
Adjustable spring sizes 1 through 4		X
Tri-pack standard (regular arm, top jamb or parallel arm mounting)	X	X

## 1100 Series Industrial Door Closers

The 1100 Series features rugged construction, adjustments for closing and latch speed, and rack and pinion operation.

### Features

- 1101BF (non-hold open) and 1111BF (hold open) door closers are adjustable spring sizes 1 through 4
- 1104BC (non-hold open) door closers are spring size 4
- Non-handed
- Full rack and pinion
- Aluminum
- Tri-packed: regular, parallel or top jamb mounting
- Adjustable backcheck valve
- Adjustable closing speed and latching speed valves
- Auxiliary door stop required
- Sleeve nuts included with all models
- 5-year limited warranty

### Optional Features

- Cover (order separately)

### Compliance Standards

- UL/cUL listed
- 1101BF/1111BF - designed to meet requirements for ANSI/BHMA A156.4 Grade 1. Door closers meet handicapped requirements for light to medium weight interior doors. 
- 1104BC - designed to meet requirements for ANSI/BHMA A156.4 Grade 2





# Door Controls



## YDC200 Economy Door Closers

The YDC200 Series is a no-fuss, economical option for aluminum storefront settings and other high volume applications.

### Features

- Adjustable spring size 1-4 (YDC201) or fixed spring size 4 (YDC204)
- Tri-packed: regular, top jamb, or parallel mounting options
- Non-handed
- Cast aluminium body and threaded adjustable arm
- Rack & pinion design
- Independent latch, sweep, and backcheck intensity valves
- Available in two finishes 689 & 690
- 5 year limited warranty
- Designed to meet Grade 1 specifications



# Electrified Products



Yale offers a range of electromechanical products to meet a variety of applications, ensuring a distinct Yale advantage. These products include nexTouch® Keypad Access Lock, alarms and alarmed devices, and electrified mortise and cylindrical locking products. Yale's electrified products incorporate the highest level of security available with the added flexibility and security of remote electrical control. Electrified hardware is ideal for interfacing with access control, security and fire alarm systems.

## Electrolynx®

What normally took an hour or more to connect now takes minutes. All Yale® electrified hardware is equipped with Electrolynx® connectors. As a standard feature, these connectors link power from the incoming source to electrified locking products, including hinges, locks, exit devices, magnetic holders and strikes.

Note: Electrified door hardware with Electrolynx® connectors require a compatible hinge.

## Mortise Locksets

- Certified ANSI/BHMA A156.13 Series 1000, Grade 1
- UL10B Listed for 3-hour fire-rated openings
- Utilizes 8800 lockset
- Continuous duty integral solenoid
- Available in 12 or 24VDC
- Fail Safe or Fail Secure Operation
- Request to Exit (REX), Latchbolt Monitoring (LBM), Deadbolt Monitoring (DBM) , Integrated Total Security (ITS) options available



## Cylindrical Locksets

- Certified ANSI/BHMA A156.2 Series 4000, Grade 1 and 2
- UL Listed
- Utilizes 5400LN, 5300LN or 4700LN lockset
- Free Wheeling lever mechanism
- Available in 12 or 24V
- External rectifier accepts AC or DC voltage
- Mechanical cylinder override
- Fail Safe or Fail Secure Operation
- Request to Exit (REX) option available (5400LN series only)





## Mortise And Cylindrical Functions

Fail Safe – Locked when power is on and unlocked when power is off.

Function Description	Mortise Model Number	Cylindrical Model Numbers
<ul style="list-style-type: none"> <li>Power on – outside lever locked</li> <li>Inside lever always free</li> <li>No key override</li> </ul>	8880	4780LN 5380LN 5480LN
<ul style="list-style-type: none"> <li>Power on – both levers locked</li> <li>No key override</li> </ul>	8884	N/A
<ul style="list-style-type: none"> <li>Power on – outside lever locked</li> <li>Mechanical key override by outside</li> </ul>	8890	4790LN 5390LN 5490LN
<ul style="list-style-type: none"> <li>Power on – both levers locked</li> <li>Mechanical key override by both sides</li> </ul>	8894-2	N/A
<ul style="list-style-type: none"> <li>Power on – outside lever locked</li> <li>Deadbolt by key outside, thumbturn inside</li> <li>Mechanical key override by outside</li> </ul>	8896	N/A
<ul style="list-style-type: none"> <li>Power on – outside lever locked</li> <li>Deadbolt by key both sides</li> <li>Mechanical key override by both sides</li> </ul>	8896-2	N/A
<ul style="list-style-type: none"> <li>Power on – both levers locked</li> <li>Deadbolt by key outside, thumbturn inside</li> <li>Mechanical key override by outside</li> </ul>	8898	N/A
<ul style="list-style-type: none"> <li>Power on – both levers locked</li> <li>Deadbolt by key both sides</li> <li>Mechanical key override by both sides</li> </ul>	8898-2	N/A

Fail Secure – Unlocked when power is on and locked when power is off.

Function Description	Mortise Model Number	Cylindrical Model Numbers
<ul style="list-style-type: none"> <li>Power off – outside lever locked</li> <li>Inside lever always free</li> <li>No key override</li> </ul>	8881	4781LN 5381LN 5481LN
<ul style="list-style-type: none"> <li>Power off – both levers locked</li> <li>No key override</li> </ul>	8885	N/A
<ul style="list-style-type: none"> <li>Power off – outside lever locked</li> <li>Mechanical key override by outside</li> </ul>	8891	4791LN 5391LN 5491LN
<ul style="list-style-type: none"> <li>Power off – both levers locked</li> <li>Mechanical key override by both sides</li> </ul>	8895-2	N/A
<ul style="list-style-type: none"> <li>Power off – outside lever locked</li> <li>Deadbolt by key outside, thumbturn inside</li> <li>Mechanical key override by outside</li> </ul>	8897	N/A
<ul style="list-style-type: none"> <li>Power off – outside lever locked</li> <li>Deadbolt by key both sides</li> <li>Mechanical key override by both sides</li> </ul>	8897-2	N/A
<ul style="list-style-type: none"> <li>Power off – both levers locked</li> <li>Deadbolt by key outside, thumbturn inside</li> <li>Mechanical key override by outside</li> </ul>	8899	N/A
<ul style="list-style-type: none"> <li>Power off – both levers locked</li> <li>Deadbolt by key both sides</li> <li>Mechanical key override by both sides</li> </ul>	8899-2	N/A

# Electrified Products



## Exit Devices

The Yale® 7000 and 6000 Series Exit Devices offer a complete range of electrical options:

- Electric Latch Retraction
- Electric Dogging
- Mortise Device Trim Control
- Touchbar Monitor or Signaling
- Outside Trim Monitor or Signaling
- Bolt Position Monitor or Signaling
- Delayed Egress
- Electric Trim Control
- Alarm

Electrified exit devices may be integrated into the monitoring security and alarm systems of most buildings.



## Exit Device Option Descriptions

A	Alarm Option	O	Trim Monitor
A-ALR	Alarm option with red screenprinted pushpad	P	Latch Retraction
B	Touchbar Monitor	S	Bolt Monitor
D	Delayed Egress	SAFE	Fail Safe Operation (Mortise)
G	Electric Dogging	SECURE	Fail Secure Operation (Mortise)
H*	Security Package (DPS)	690F	Fail Safe Electrified Trim
MELR	Motorized Electric Latch Retraction	691F	Fail Secure Electrified Trim

**Note: Any combination of the following options cannot be ordered together:**  
**1) P, G, or D 2) B or A 3) D, B or A**  
**\*Only available for rim and SquareBolt® Devices when used with Delayed Egress option.**

## Electrified Options Chart

Model #	Exit Device Description	A	A-ALR	B	G	H	MELR*	O	P*	S	SAFE	SECURE	690F	691F
6100(F)	Rim Exit Device (Wide)	x	x	x	x	x		x	x	x			x	x
7100(F)	Rim Exit Device (Wide)	x		x	x	x	x	x		x			x	x
6110(F)	Surface Vertical Rod (Narrow)	x		x	x			x	x	x			x	x
7110(F)	Surface Vertical Rod (Wide)	x		x	x		x	x		x			x	x
6120(F)	Surface Vertical Rod (Narrow)	x		x	x			x	x	x			x	x
7120(F)	Concealed Vertical Rod (Wide)	x		x	x		x	x		x			x	x
6130(F) & 7130(F)	Mortise Exit Device (Wide)	x		x	x		x	x	x	x	x	x		
6150(F) & 7150(F)	Rim SquareBolt® Device (Wide)	x		x	x	x	x	x	x	x			x	x
6160(F) & 7160(F)	Concealed Vertical Rod (Wide)	x		x	x		x	x	x	x			x	x
6170(F) & 7170(F)	Surface Vertical Rod (Wide)	x		x	x		x	x	x	x			x	x
6200 & 7200(M)(F)	Rim Exit Device (Narrow)	x		x	x		x		x	x				
6210 & 7210(M)(F)	Surface Vertical Rod (Narrow)	x		x	x		x		x	x				
6220 & 7220(M)(F)	Concealed Vertical Rod (Narrow)	x		x	x		x		x	x				
6250 & 7250(M)(F)	Rim SquareBolt® Device (Narrow)	x		x	x		x		x	x				

\*MELR available for 7000 Series only; P available for 6000 Series only

## Stand-Alone Door Alarm

The SDA16 stand-alone battery operated door alarm is designed to continually monitor the status of a door. When the door is opened without authorization, an alarm is triggered to alert the security violation. This alarm features a Peizo horn which blasts a deafening 105+ decibels to alert the violation.



This unit is ideal for emergency doors as well as stairwell doors and rear exit doors in retail environments. The unit, which can also be hardwired, easily complements existing hardware, making any opening alarmed. The SDA16 door alarm is typically mounted on the interior of the door frame or door and is paired with a magnet mounted on the opposing side of the door gap.

## Remote Mounting

The SDA16 can be installed remotely from the door by attaching the contacts to the door and frame. The unit can be installed up to 6 feet from the door. This provides the ideal solution for circumstances where exposure to weather may be an issue. To order specify "SDA16XL".

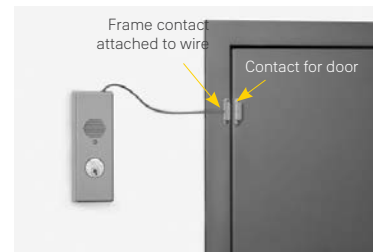

Note: Actual wire length is 6 feet.

# nexTouch® Keypad Locks



Yale nexTouch locks combine a modern look and innovative access control technology with an array of bold new features, offering an attractive access control solution in many applications. With a heavy-duty design and ANSI/BHMA Grade 1 certification, nexTouch provides durable and reliable security in multiple platforms to a range of commercial facilities including offices, retail and multi-family facilities.

## Standalone Keypad

Great for restrooms, offices, storage closets and more, nexTouch as a standalone keypad is easy to install, program, and manage access with PIN codes.



## Data-on-Card

In new construction or retrofit projects for multi-family facilities, the data-on-card functionality of nexTouch pairs with Yale Accentra™ software for use with key cards or fobs.



## Features

- Choice of capacitive touchscreen or tactile pushbutton keypad
- Ergonomic, easy-to-use design
- Keyless entry and management
- Access with PIN codes
- Voice-guided programming in 3 languages
- Privacy feature with Door Position Switch
- 9V battery power backup feature
- Low battery indicator
- Three volume modes
- Certified ANSI/BHMA Grade 1 **BHMA CERTIFIED**
- UL/cUL listed for use on fire doors
- ADA compliant and decorative levers available
- Optional cylinder/key override – full range of Yale® 6-pin conventional, protected and security cylinders available including large and small format interchangeable core
- Weather resistant
- 3-year electronic and mechanical, 1-year finish

# nexTouch® Keypad Locks



## Cylindrical

### Functions

^Model Number	Keypad	Function
NTB633	Pushbutton	Without cylinder override
NTB643	Touchscreen	
NTB613	Pushbutton	With cylinder override
NTB623	Touchscreen	



### Trim



## Sectional Mortise



### Functions

^Model Number	Keypad	Function
NTM633	Pushbutton	No deadbolt without cylinder override
NTM643	Touchscreen	
NTM613	Pushbutton	No deadbolt with cylinder override
NTM623	Touchscreen	
NTM638	Pushbutton	Deadbolt without cylinder override
NTM648	Touchscreen	
NTM618	Pushbutton	Deadbolt with Cylinder override
NTM628	Touchscreen	



### Trim\*

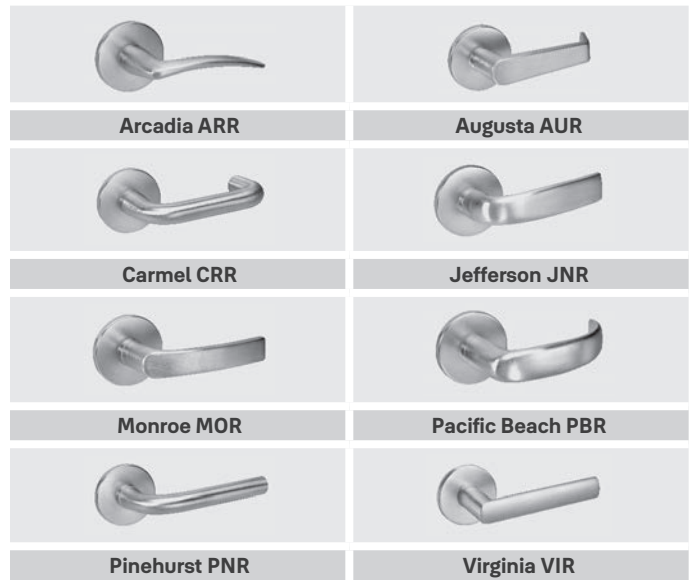

\*Full line of Reflections® decorative levers (except Spree) also available, see page 3.

^All nexTouch lock model numbers noted on this page can be upgraded for use with the Yale Accentra Cloud platform by installing the Accentra radio module available to all Yale Multi Family Housing Certified Integrators. **These model numbers can NOT be upgraded for use with a Z-Wave compatible system.**

# nexTouch® Keypad Locks



## Exit Trim

### Functions

Model Number	Keypad	Function
NTT613	Pushbutton	Exit trim, key override
NTT623	Touchscreen	Exit trim, key override



### Trim



## Compatible Exit Devices

Thanks to its patented adjustable mounting posts, Yale nexTouch exit trim is compatible with several makes and models of exit devices right out of the box, without the need for separate mounting hardware. Check the chart below to see if yours is a fit.

Manufacturer	Model/Series Number*
Arrow	3880, S1250
Corbin Russwin	PED/ED5200, PED/ED5200S
Dorma	9300
Falcon®	24, 25
SARGENT	PE8000/8000
Von Duprin®	98, 99
Yale	1800, 2100, 6000, 7000

\*Compatible with rim device only. Please contact Technical Product Support for more information.

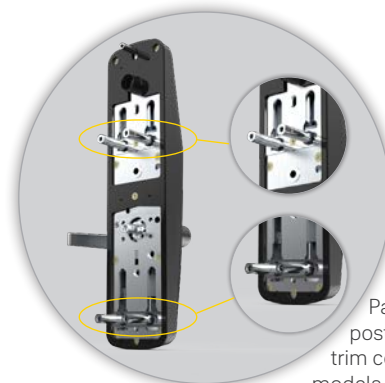

Patented adjustable mounting posts make the nexTouch exit trim compatible with many exit device models (see chart at left).

^All nexTouch lock model numbers noted on this page can be upgraded for use with the Yale Accentra Cloud platform by installing the Accentra radio module available to all Yale Multi Family Housing Certified Integrators. **These model numbers can NOT be upgraded for use with a Z-Wave compatible system.**



**Trusted every day**

**Phone**

1-855-557-5078

**Customer Service Email**

customerservice.yale@assaabloy.com

**Technical Product Support Email**

techsupport.yale@assaabloy.com

**Order Entry Email**

orders.yaleus@assaabloy.com

**Fax**

1-800-338-0965

**Website**

www.yalecommercial.com

## Contact Us

**U.S.A.**

**Yale Locks & Hardware**

Address: 225 Episcopal Road

Berlin, CT 06037-4004

Tel: 1-800-438-1951

Fax: 1-800-338-0965

yalecommercial.com

**Canada:**

**ASSA ABLOY Door Security Solutions Canada**

Address: 160 Four Valley Drive

Vaughan, Ontario L4K 4T9

Tel: 1-800-461-3007

Fax: 1-800-461-8989

assaabloydss.ca

**International:**

**ASSA ABLOY Americas International**

Tel: 1-905-821-7775

Fax: 1-905-821-1429

assaabloyai.com

**MicroShield®**

As part of their promise to provide innovative solutions to their customers, certain ASSA ABLOY Group brands offer the MicroShield® technology, a silver-based antimicrobial coating designed to inhibit the growth of bacteria.

Microshield® is a registered trademark of ASSA ABLOY Access and Egress Hardware Group, Inc.



The Agion antimicrobial is not intended as a substitute for good hygiene. Coated products must still be cleaned to ensure the surfaces will be free of destructive microbes. ASSA ABLOY makes no representations or warranties, express or implied, as to the efficacy of the Agion antimicrobial. A copy of the Agion warranty is available upon request. Agion is a registered trademark of Agion Technologies, Inc., Wakefield, MA, USA.

**THE YALE BRAND**, with its unparalleled global reach and range of products, reassures more people in more countries than any other consumer locking solution.

**THE ASSA ABLOY GROUP** is the world's leading manufacturer and supplier of locking solutions, dedicated to satisfying end-user needs for security, safety and convenience.

Yale Commercial is a business associated with ASSA ABLOY Access and Egress Hardware Group, Inc., an ASSA ABLOY Group company. Copyright © 1999-2023, ASSA ABLOY Access and Egress Hardware Group, Inc. All rights reserved. Reproduction in whole or in part without the express written permission of ASSA ABLOY Access and Egress Hardware Group, Inc. is prohibited. Patent pending and/or patent [www.assaabloydss.com/patents](http://www.assaabloydss.com/patents).