

VON DUPRIN®

55 Series

Exit device



Introduction

Function and style

Since creating the first exit device, Von Duprin® remains the trusted name in the industry by creating products that meet the highest standards for fire and life safety. It's evident in the meticulous engineering behind every exit device. Today, Von Duprin's product line is available in a wide range of styles and finishes to blend seamlessly into varying aesthetic environments.

The 55 Series is a narrow stile device with a classic look that's ideal for retro-inspired architecture and historical buildings. Several mechanical, electronic and finish options can be customized to meet the needs of your facility. Take advantage of field reversible handing and flexible field sizing for several surface-mounted vertical rod and rim applications.

Passion driving performance

With superior products comes exceptional customer care. Von Duprin customers are supported by industry-leading expertise. Allegion's representatives average more than 15 years of experience, so you're assured to receive knowledgeable advice on fire and life safety codes, installation resources and more. And for those looking to take their skills to the next level, Allegion offers instructor-led workshops, videos and online courses. It's another way Von Duprin stands by our customers—today, tomorrow and for years to come.

VON DUPRIN
Administrative Offices
2720 Tobey Dr.
Indianapolis, IN 46219

Customer Service
877-671-7011
800-999-0328 - Fax

Technical Support
877-671-7011

Table of contents

Exit hardware

Rim devices

55	8
55 Trim	9

Mortise lock devices

5575	10
Trim	11

Concealed vertical rod devices

5547	14
Trim	15

Wood door concealed vertical rod devices

5547WDC	18
Trim	19

Fire hardware

Mortise lock devices

5575-F	12
Trim	13

Concealed vertical rod devices

5547-F	16
Trim	17

Wood door concealed vertical rod devices

5547WDC-F	20
Trim	21



Options and accessories

Applications & trim operation	Double door applications Door handing outside trim operation Lever styles	Device accessories	Cover / Adapter plates Cylinders Optional levers Power supplies conversion kit — NL
Trim options			
Strike options/ Stile information	Strike application/minimum stile strikes for rim devices	Additional information	UL listed — fire exit hardware label/ opening ANSI function, grade & type

Symbols



Indicates fire rated application



indicates ADA products

How to order

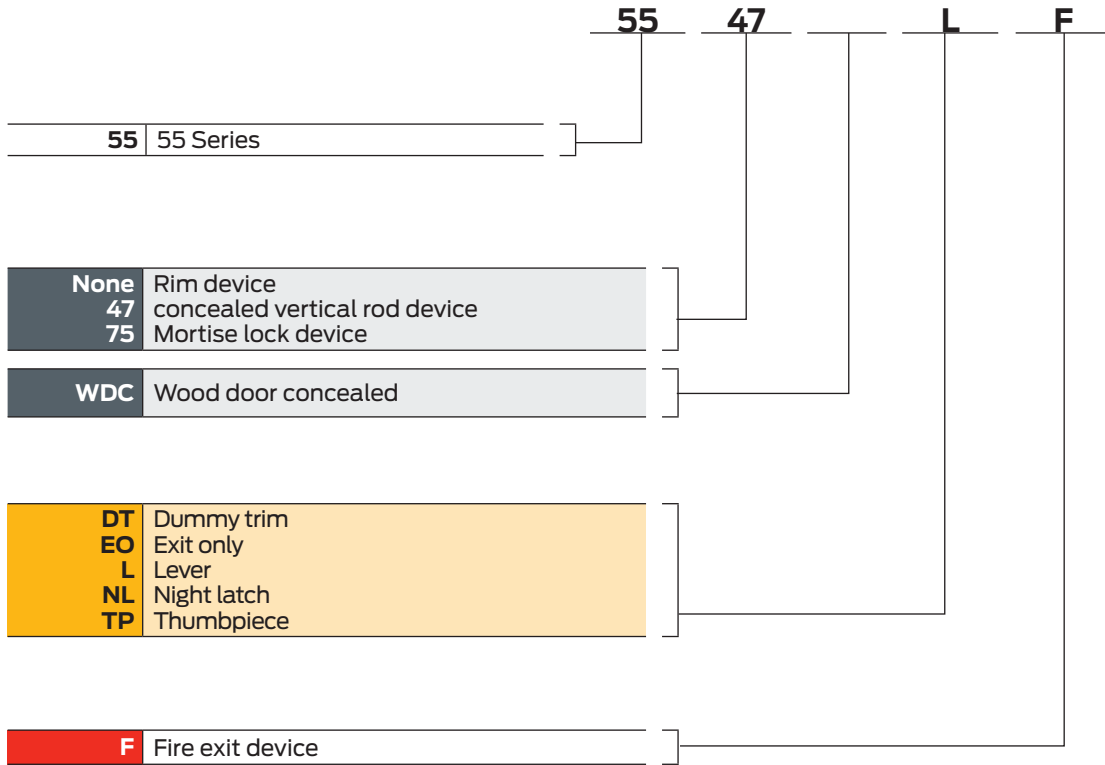

Rim and mortise lock devices, specify:

- Exit device model number and trim selection.
Examples: 55EO (exit only and no outside trim). 55DT (includes standard 550 DT trim).
- Door width 3' (914mm), or 4' (1219mm).
- Door thickness if other than 1³/₄" (44mm).
- Door and frame material if other than hollow metal.
- Finish, see page 28.
- Handing, LHR or RHR.

Vertical rod devices, specify:

- Exit device model number and trim selection.
Examples: 5547EO (exit only and no outside trim). 5547DT (includes standard 550DT trim).
- Door width 3' (914mm), or 4' (1219mm).
- Door thickness if other than 1³/₄" (44mm).
- Door height if other than 8' (2438mm), extension rods must be ordered.
- Door and frame material if other than hollow metal.
- Finish, see page 28.
- Handing, LHR or RHR.

Popular double door applications

Double door applications

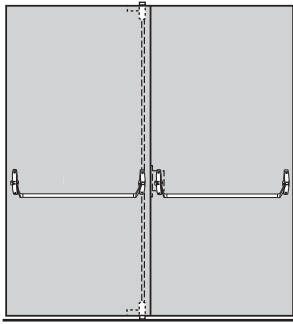

Mortise lock and vertical rod device combination — same direction
*hollow metal only

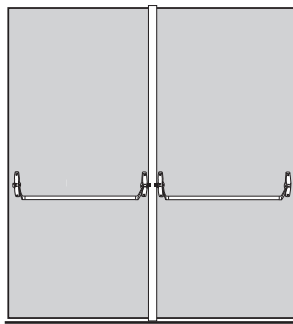

Two rim devices with mullion — same direction

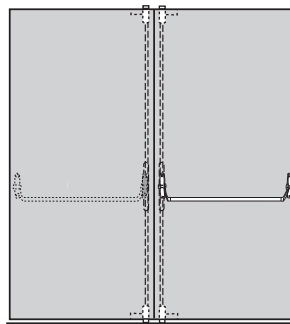

Two vertical rods — double egress

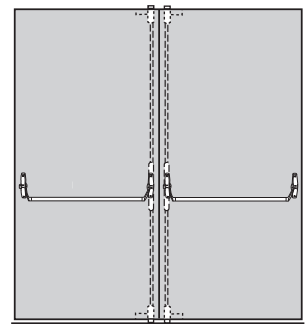

Two vertical rod devices — same direction (do not use with overlapping astragal)

Door handing

Left hand reverse orientation



Right hand reverse orientation



LHR
(Left hand reverse)



RHR
(Right hand reverse)

Outside

Outside trim operation

Trim operation lever

Standard operation



Key locks and unlocks lever.

NL Function



Lever is locked when key is removed.
(ANSI O9 function)

Blank escutcheon

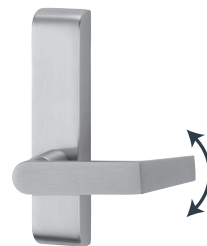

Lever always active. BE suffix,
E.G., 371L-BE.

Standard trim

Series 550

Heavy aluminum bracket 10" (25mm) with stainless steel or brass pull bar. 550DT with NL function is furnished with 110MD or WD rim device. On 555NL (Metal) and 556NL (Wood), the cylinder locates in pull return. Cylinder must be ordered separately.



550DT



555NL
(5547 only)



556NL
(5547WDC only)

Series 376T

Thumbturn control has a forged brass 7/8" (25 mm) thick escutcheon. Often used with DT trim or pull. An NL cylinder plate is included with thumbturn control for night latch operation if required. BE blank escutcheon is available, specify 376T-BE.



376T



375L (5575-F)

Series 370L

Lever control has a forged brass 7/8" (25 mm) thick escutcheon. Optional lever designs are available. An NL cylinder plate is included with lever control for night latch. BE Blank escutcheon is available, specify 371L-BE.



371L (5547-F)
376L (5547/5547WDC)
379L (55 Rim)

Lever styles

Standard levers



01



02
Knurling available



03
Knurling available



06
Default lever
Knurling available



07



12
(Handed)



17
Knurling available

55 Rim exit device



55 Rim devices for all types of single and double doors with mullion, UL listed for accident hazard installations. Fits doors stiles as narrow as 1³/₄" (44 mm). Specify for 2¹/₄" door. Device is field reversible.

Finishes – US3, US4, US10B, US10, US26, US26D

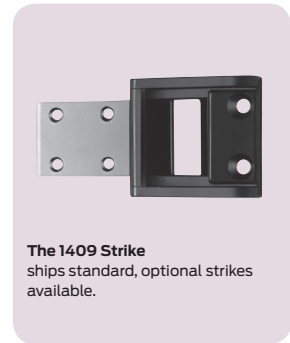

The 1409 Strike ships standard, optional strikes available.

Hex key dogging comes standard on 55 Rim exit device



RX



Crossbar monitor switch

- Signals use of an opening
- SPDT switch to monitor crossbar

Specifications

Device functions	Device ships EO/DT/NL/L
Crossbar length	30" for 3' door, 42" for 4' door
Crossbar height to finished floor	36 ⁹ / ₈ " (935 mm) at center
Lock stile case	7 ¹ / ₄ " x 1 ¹ / ₈ " x 2 ¹ / ₄ " (184 mm x 30 mm x 57 mm)
Hinge stile case	7 ¹ / ₄ " x 1 ¹ / ₈ " x 2 ¹ / ₄ " (184 mm x 30 mm x 57 mm)
Crossbar tubing	1" (25 mm)
Projection	Crossbar neutral – 3 ³ / ₄ " (95 mm) Crossbar depressed – 2 ³ / ₈ " (60 mm)
Latch bolt	3/4" (19 mm), throw
Fasteners and Sex bolts (SBN)	Includes screw pack for 1 ³ / ₄ " (44 mm) and 2 ¹ / ₄ " (57 mm) thick metal or wood doors. Sex nuts and bolts included.
Outside trim	Standard 379L 550DT x 110NL-MD 550DT x 110NL-WD 550DT
Electrical options	RX Crossbar monitor switch E Electric unlocking (BE trim only)
Mechanical options	RCB Reinforced crossbar KN Knurled crossbar
Strikes	1409 - Dull black

Standard trim

	EO	DT	NL	L
				
	Exit only	Dummy trim Pull when dogged	Night latch Key retracts latch bolt	Lever Locks/unlocks
Product description	55EO	55DT	55NL	55L
Trim description	—	550DT	550DT/110MD	379L
Escutcheon plate size	—	—	—	7½" x 1⅞"
Pull overall length	—	3⅝" x 11 9/16"	3⅝" x 11 9/16"	—
Pull center to center	—	10"	10"	—
Projection	—	2 5/8" x 1 7/8"	2 5/8" x 1 7/8"	2 5/8"
ANSI function	01	02	03	08
Cylinder type	—	—	Rim	Mortise
Handing	Handed	Handed	Handed	Handed
Sex bolts furnished	4	4	4	—

Notes

5575 Mortise lock exit device



5575 Mortise lock devices for all types of single and double doors. UL listed for accident hazard installations.

The 7500 Mortise lock is field reversible without removing the lock from the door. It has a non-handed auxiliary bolt for deadlocking and a faceplate with an adjustable bevel. Wood doors required 589 cover plate. Specify for 2 1/4" door.

Finishes – US3, US4, US10B, US10, US26, US26D

Hex key dogging comes standard on 5575 Series mortise lock exit devices





Specifications	
Device functions	EO/DT/NL/L
Crossbar length	30" for 3' door, 42" for 4' door
Crossbar height to finished floor	36 13/16" (935 mm) at center
Latch bolt height to finished floor	40 3/32" (1018 mm) at center
Lock stile case	7 1/4" x 1 3/16" x 2 1/4" (184 mm x 30 mm x 57 mm)
Lock case	4 5/8" x 5 3/4" x 1 1/16" (117 mm x 146 mm x 27 mm)
Faceplate	1 1/4" x 8" x 7/32" (32 mm x 203 mm x 6 mm)
Cylinder backset	2 3/4" (70 mm)
Hinge stile case	7 1/4" x 1 3/16" x 2 1/4" (184 mm x 30 mm x 57 mm)
Crossbar tubing	1" (25 mm)
Projection	Crossbar neutral – 3 3/4" (95 mm) Crossbar depressed – 2 3/8" (60 mm)
Latch bolt	Anti-friction, 3/4" (19 mm), throw
Fasteners and Sex bolts (SBN)	Includes screw pack for 1 3/4" (44 mm) and 2 1/4" (57 mm) thick metal or wood doors. Sex nuts and bolts included.
Outside trim	Standard 375L 550DT
Electrical options	RX Crossbar monitor switch E Electric unlocking (BE trim only)
Mechanical options	RCB Reinforced crossbar KN Knurled crossbar
Strikes	575 - Dull black

RX

Crossbar monitor switch

- Signals use of an opening
- SPDT switch to monitor crossbar

Standard trim

	EO	DT	NL	L
				
	Exit only	Dummy trim Pull when dogged	Night latch Key retracts latch bolt	Lever Locks/unlocks
Product description	5575EO	5575DT	5575NL	5575L
Trim description	—	550DT	550DT	375L
Escutcheon plate size	—	—	—	10½" x 2"
Pull overall length	—	3 ⁵ / ₈ " x 11 ⁹ / ₁₆ "	3 ⁵ / ₈ " x 11 ⁹ / ₁₆ "	—
Pull center to center	—	10"	10"	—
Projection	—	2 ⁵ / ₈ " x 1 ⁷ / ₈ "	2 ⁵ / ₈ " x 1 ⁷ / ₈ "	2 ⁵ / ₈ "
ANSI function	01	02	03	08
Cylinder type	—	—	1¼" Mortise	Mortise
Handing	Handed	Handed	Handed	Handed
Sex bolts furnished	2	2	2	—

Notes

5575-F Mortise lock fire exit device



5575-F fire exit mortise lock devices for 4' x 10' (1219 mm x 3048 mm) single or 8' x 8' (2438 mm x 2438 mm) double metal doors, UL listed for up to 3 hour labeled installations. Fits door stiles as narrow as 4³/₄" (121 mm). Specify for 2¹/₄" door.

The 7500 mortise lock is equipped with a ³/₄" (19mm) anti-friction latch bolt which is field reversible without removing the lock from the door. It has a non-handed auxiliary bolt for deadlocking and a faceplate with an adjustable bevel. Wood door required 589 cover plate.

Finishes – US3, US4, US10B, US10, US26, US26D

Specifications



Device functions	EO/NL/L
Crossbar length	30" for 3' door, 42" for 4' door
Crossbar height to finished floor	36 ¹³ / ₁₆ " (935 mm) at center
Latch bolt height to finished floor	40 ³ / ₃₂ " (1018 mm) at center
Lock stile case	7 ¹ / ₄ " x 1 ³ / ₁₆ " x 2 ¹ / ₄ " (184 mm x 30 mm x 57 mm)
Lock case	4 ⁵ / ₈ " x 5 ³ / ₄ " x 1 ¹ / ₁₆ " (117 mm x 146 mm x 27 mm)
Faceplate	1 ¹ / ₄ " x 8" x ⁷ / ₃₂ " (32 mm x 203 mm x 6 mm)
Cylinder backset	2 ³ / ₄ " (70 mm)
Hinge stile case	7 ¹ / ₄ " x 1 ³ / ₁₆ " x 2 ¹ / ₄ " (184 mm x 30 mm x 57 mm)
Crossbar tubing	1" (25 mm)
Projection	Crossbar neutral – 3 ³ / ₄ " (95 mm) Crossbar depressed – 2 ³ / ₈ " (60 mm)
Latch bolt	Anti-friction, ³ / ₄ " (19 mm), throw
Fasteners and Sex bolts (SBN)	Includes screw pack for 1 ³ / ₄ " (44 mm) and 2 ¹ / ₄ " (57 mm) thick metal or wood doors. Sex nuts and bolts included.
Outside trim	Standard 375L 550DT
Electrical options	RX Crossbar monitor switch E Electric unlocking (BE trim only)
Mechanical options	RCB Reinforced crossbar KN Knurled crossbar
Strikes	575 - Dull black

RX

Crossbar monitor switch

- Signals use of an opening
- SPDT switch to monitor crossbar

Standard trim

	EO	NL	L
			
	Exit only	Night latch Key retracts latch bolt	Lever Locks/unlocks
Product description	5575EO-F	5575NL-F	5575L-F
Trim description	—	550DT	375L
Escutcheon plate size	—	—	10 1/2" x 2"
Pull overall length	—	3 5/8" x 11 9/16"	—
Pull center to center	—	10"	—
Projection	—	2 5/8" x 1 7/8"	2 5/8"
ANSI function	01	03	08
Cylinder type	—	1 1/4" Mortise	Mortise
Handing	Handed	Handed	Handed
Sex bolts furnished	2	2	—

Notes



5575-F Mortise lock fire exit device

5547 Concealed vertical rod exit device

5547 Concealed vertical rod exit device



5547 Concealed vertical rod devices for use on single or double metal doors. UL listed for accident hazard installations and fits door stiles as narrow as 1 3/4" (44 mm). Specify for 2 1/4" door. Standard device fits 6' 8" to 8'0" door height.

Finishes – US3, US4, US10, US10B, US26, US26D

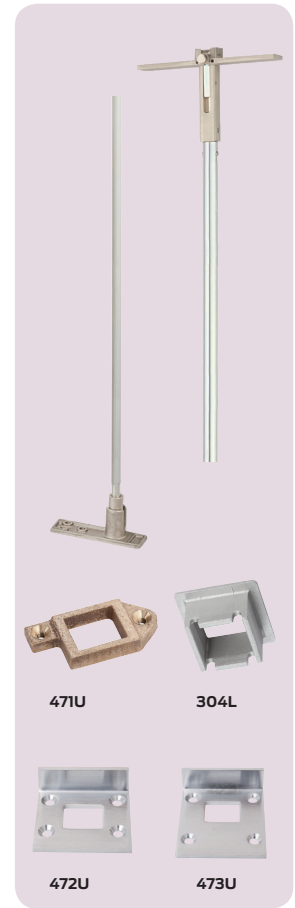

Hex key dogging comes standard on 5547 Series concealed vertical rod exit devices







RX
Crossbar monitor switch

- Signals use of an opening
- SPDT switch to monitor crossbar

Specifications	
Device functions	EO/DT/NL/L/TL
Crossbar length	30" for 3' door, 42" for 4' door, Handed, field reversible
Crossbar height to finished floor	36 13/16" (935 mm) at center
Lock stile case	7 1/4" x 1 3/16" x 2 1/4" (184 mm x 30 mm x 57 mm)
Hinge stile case	7 1/4" x 1 3/16" x 2 1/4" (184 mm x 30 mm x 57 mm)
Vertical rods-hexagon	3/8" (10 mm) adjustable top rod
Crossbar tubing	1" (25 mm)
Projection	Crossbar neutral – 3 3/4" (95 mm) Crossbar depressed – 2 3/8" (60 mm)
Latch bolt	1/2" (13 mm), throw
Fasteners and Sex bolts (SBN)	Sex nuts and bolts for mounting are included for 1 3/4" (44 mm) and 2 1/4" (57 mm) thick doors, when specified.
Wood frame strikes	472U for 1 3/4" door and 473U for 2 1/2" door.
Outside trim	Hollow metal 555NL 550DT 376 L 376T x 550DT
Electrical options	RX Crossbar monitor switch E Electric unlocking (BE trim only)
Mechanical options	RCB Reinforced crossbar KN Knurled crossbar
Strikes	471U - Top-unfinished 304L - Bottom-unfinished

Standard trim

	EO	DT 	NL 	L 	TL 
	Exit only	Dummy trim Pull when dogged	Night latch Key retracts latch bolt	Lever Key unlocks & locks	Key Locks Thumbturn
Product description	5547EO	5547DT	5547NL	5547L	5547TL
Trim description	—	550DT	555NL	376L	550DT/376T
Escutcheon plate size	—	—	—	7½" x 1⅞"	7½" x 1⅞"
Pull overall length	—	11 9/16" x 3 5/8"	11 9/16" x 3 5/8"	—	—
Projection	—	2 5/8" x 1 7/8"	2 5/8" x 1 7/8"	2 5/8"	1 3/16"
ANSI function	01	02	03	08	11
Cylinder type	—	—	Rim	Mortise	Mortise
Handing	—	Handed	Handed	Handed	Handed
Sex bolts furnished	2	2	2	2	2

Notes

- For 5547L, minimum control centerline of lever or thumbturn is 49 7/8" and the minimum stile width is 1 3/4".
- Electrified lever operation available, must be blank escutcheon (L-BE).
- NY5547L is available to meet ADA requirements of 45 13/16" lever height.
- NY5547 with a 38" device centerline is available to meet California ADA requirements of 44" lever height.

5547-F Concealed vertical rod fire exit device

5547-F Concealed vertical rod fire exit device



5547-F Fire exit concealed vertical rod devices for use on 8' x 8' (2438 mm x 2438 mm) double metal doors swinging same direction or double egress. UL listed for up to 3 hour labeled installations and fits door stiles as narrow as 4³/₄" (121 mm). Standard device fits 6'8" to 8'0" door height

Double doors swinging same direction using a pair of 5547-F devices must not have an overlapping astragal.

Finishes – US3, US4, US10, US10B, US26, US26D



301L

Specifications



Device functions	EO/L/TL	
Crossbar length	30" for 3' door, 42" for 4' door	
Crossbar height to finished floor	36 ¹³ / ₁₆ " (935 mm) at center	
Lock stile case	7 ¹ / ₄ " x 1 ³ / ₁₆ " x 2 ¹ / ₄ " (184 mm x 30 mm x 57 mm)	
Hinge stile case	7 ¹ / ₄ " x 1 ³ / ₁₆ " x 2 ¹ / ₄ " (184 mm x 30 mm x 57 mm)	
Vertical rods-hexagon	3 ³ / ₈ " (10 mm) adjustable top rod	
Crossbar tubing	1" (25 mm)	
Projection	Crossbar neutral – 3 ³ / ₄ " (95 mm) Crossbar depressed – 2 ³ / ₈ " (60 mm)	
Latch bolt	5/8", throw	
Fasteners and Sex bolts (SBN)	Sex nuts and bolts for mounting are included for 1 ³ / ₄ " (44 mm) and 2 ¹ / ₄ " (57 mm) thick doors, when specified.	
Outside trim	Hollow metal 376T x 609DT 371L	
Electrical options	RX	Crossbar monitor switch
	E	Electric unlocking (BE trim only)
Mechanical options	RCB	Reinforced crossbar
	KN	Knurled crossbar
Strikes	301L - Bottom-unfinished	

RX

Crossbar monitor switch

- Signals use of an opening
- SPDT switch to monitor crossbar

Standard trim

	EO	L	TL
	Exit only	 <p>Lever Key unlocks & locks</p>	 <p>Key locks Thumbturn</p>
Product description	5547EO-F	5547L-F	5547TL-F
Trim description	—	371L	609DT/376T
Escutcheon plate size	—	7 1/2" x 1 11/16"	7 1/2" x 1 11/16"
Pull overall length	—	—	—
Projection	—	2 5/8"	1 13/16"
ANSI function	01	08	11
Cylinder type	—	Moritise	Moritise
Handing	—	Handed	Handed
Optional trim			
Sex bolts furnished	2	2	2

Notes

- Electrified lever operation available, must be blank escutcheon (L-BE).



5547WDC Wood door concealed vertical rod exit device

5547WDC Wood door concealed vertical rod exit device



5547WDC Concealed vertical rod devices for use on single or double wood doors. Fits door stiles as narrow as 4" (102 mm).

Finishes – US3, US4, US10, US10B, US26, US26D







Hex key dogging comes standard on 5547WDC Series wood concealed vertical rod exit devices



RX
Crossbar monitor switch
 • Signals use of an opening
 • SPDT switch to monitor crossbar

Specifications	
Device functions	EO/DT/NL/L /TL
Crossbar length	30" for 3' door, 42" for 4' door
Crossbar height to finished floor	36 ¹³ / ₁₆ " (935 mm) at center
Lock stile case	7 ¹ / ₄ " x 1 ¹³ / ₁₆ " x 2 ¹ / ₄ " (184 mm x 30 mm x 57 mm)
Hinge stile case	7 ¹ / ₄ " x 1 ³ / ₁₆ " x 2 ¹ / ₄ " (184 mm x 30 mm x 57 mm)
Vertical rods-hexagon	³ / ₈ " (10 mm) adjustable top rod
Crossbar tubing	1" (25 mm)
Projection	Crossbar neutral – 3 ³ / ₄ " (95 mm) Crossbar depressed – 2 ³ / ₈ " (60 mm)
Latch bolt	5/8" (16mm) , throw
Fasteners and Sex bolts (SBN)	Sex nuts and bolts for mounting are included for 1 ³ / ₄ " (44 mm) and 2 ¹ / ₄ " (57 mm) thick doors, when specified.
Wood frame strikes	472U for 1 ³ / ₄ " door and 473U for 2 ¹ / ₄ " door.
Outside trim	Wood door 376-WDC-L 556NL 550DT 376-WDC-T x 550DT
Electrical options	RX Crossbar monitor switch E Electric unlocking (BE trim only)
Mechanical options	RCB Reinforced crossbar KN Knurled crossbar
Strikes	378 - Top 304L - Bottom, unfinished

Standard trim

	EO Exit only	DT  Dummy trim Pull when dogged	NL  Night latch Key retracts latch bolt	L  Lever Key unlocks & locks	TL  Key locks thumbturn
Product description	5547WDC-EO	5547WDC-DT	5547WDC-NL	5547WDC- L	5547WDC-TL
Trim description	—	550DT	556-NL	376WDC-L	550DT/376WDC-T
Escutcheon plate size	—	—	—	7½" x 1⅛"	7½" x 1⅛"
Pull overall length	—	11 9⁄16" x 3 5⁄8"	11 9⁄16" x 3 5⁄8"	—	—
Projection	—	2 5⁄8" x 1 7⁄8"	2 5⁄8" x 1 7⁄8"	2 5⁄8"	1 13⁄16"
ANSI function	01	02	03	08	11
Cylinder type	—	—	Rim	Mortise	Mortise
Handing	—	Handed	Handed	Handed	Handed
Sex bolts furnished	2	2	2	2	2

Notes

- For 5547WDC-L, minimum control centerline of lever or thumbturn is 45³/₁₆" and the minimum stile width is 1³/₄".
If standard mounting height is required, use 5547-F x 371L
- NY5547WDC-L with a 38" device centerline is available to meet California ADA requirements of 44" lever height.

🔥 5547WDC-F Wood door concealed vertical rod fire exit device



5547WDC-F Fire exit concealed vertical rod devices for use on 8' x 9'3" (2438 mm x 2819 mm) double wood doors swinging same direction or double egress. UL listed for up to 90 minute doors and fits stiles as narrow as 4³/₄" (121 mm). Standard device fits 6'8" to 8'0" door height

Double doors swinging same direction using a pair of 5547WDC-F devices must not have an overlapping astragal. Device is field reversible.

Finishes – US3, US4, US10, US10B, US26, US26D



Specifications	
Device functions	EO/L/TL /NL
Crossbar length	30" for 3' door, 42" for 4' door
Crossbar height to finished floor	36 ¹³ / ₁₆ " (935 mm) at center
Lock stile case	7 ¹ / ₄ " x 1 ³ / ₁₆ " x 2 ¹ / ₄ " (184 mm x 30 mm x 57 mm)
Hinge stile case	7 ¹ / ₄ " x 1 ³ / ₁₆ " x 2 ¹ / ₄ " (184 mm x 30 mm x 57 mm)
Vertical rods-hexagon	³ / ₈ " (10 mm) adjustable top rod
Crossbar tubing	1" (25 mm)
Projection	Crossbar neutral – 3 ³ / ₄ " (95 mm) Crossbar depressed – 2 ³ / ₈ " (60 mm)
Latch bolt	⁵ / ₈ " , throw
Fasteners and Sex bolts (SBN)	Sex nuts and bolts for mounting are included for 1 ³ / ₄ " (44 mm) and 2 ¹ / ₄ " (57 mm) thick doors, when specified.
Wood frame strikes	472U for 1 ³ / ₄ " door and 473U for 2 ¹ / ₄ " door.
Outside trim	Wood door 376WDC-L 556NL 550DT 376WDC-T x 550DT
Electrical options	RX Crossbar monitor switch E Electric unlocking (BE trim only)
Mechanical options	RCB Reinforced crossbar KN Knurled crossbar
Strikes	378 - Top 304L - Bottom, unfinished

RX
Crossbar monitor switch

- Signals use of an opening
- SPDT switch to monitor crossbar

5547WDC-F Wood door concealed vertical rod fire exit device

Standard trim

	EO	NL 	L 	TL 
	Exit only	Night latch Key retracts latch bolt	Lever Key unlocks & locks	Key locks thumbturn
Product description	5547WDC-EO-F	5547WDC-NL-F	5547WDC-L-F	5547WDC-TL-F
Trim description	—	556NL	WDC-L	550DT/376WDC-T
Escutcheon plate size	—	—	7½" x 1 ¹¹ / ₁₆ "	7½" x 1 ¹¹ / ₁₆ "
Pull overall length	—	11 ⁹ / ₁₆ " x 3 ⁵ / ₈ "	—	—
Projection	—	2 ⁵ / ₈ " x 1 ⁷ / ₈ "	2 ⁵ / ₈ "	1 ¹³ / ₁₆ "
ANSI function	01	03	08	11
Cylinder type	—	Rim	Mortise	Mortise
Handing	—	Handed	Handed	Handed
Sex bolts furnished	2	2	2	2

Notes

- For 5547WDC-L, minimum control centerline of lever or thumbturn is 45³/₁₆" and the minimum stile width is 1³/₄".
If standard mounting height is required, use 5547-F x 371L
- NY5547WDC-L with a 38" device centerline is available to meet California ADA requirements of 44" lever height.

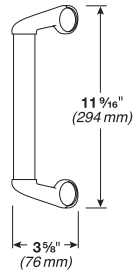
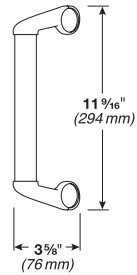
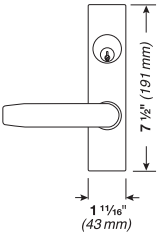
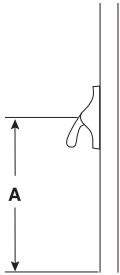
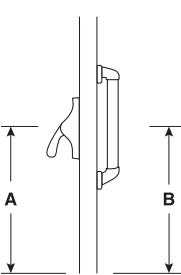
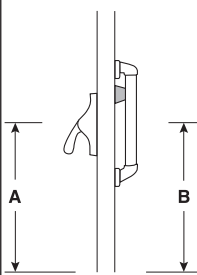
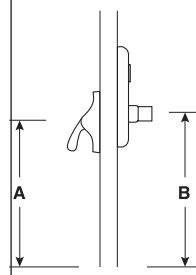

Trim options

Function	01	02	03	08	
	Exit only	Pull when dogged	Key retracts latch bolt	Key locks lever	
Trim number and dimensions		550DT 	550DT 555NL-5547 556NL-5547WDC 	371L-5547F 376L-5547/5547WDC 379L-55 Rim 	
Device/trim center line to finished floor					
Projection/Offset	—	2 ⁵ / ₈ " (67 mm) 1 ⁷ / ₈ " (48 mm)	2 ⁵ / ₈ " (67 mm) 1 ⁷ / ₈ " (48 mm)	2 ⁵ / ₈ " (67 mm)	
Rim	Panic	55EO	55DT	55NL	55L
	Ctr. line	A 39 ¹³ / ₁₆ " (1011 mm)	A 39 ¹³ / ₁₆ " (1011 mm) B 39 ¹³ / ₁₆ " (1011 mm)	A 39 ¹³ / ₁₆ " (1011 mm) B 39 ¹³ / ₁₆ " (1011 mm)	A 39 ¹³ / ₁₆ " (1011 mm)
Mortise lock	Panic	5575EO	5575DT	5575NL	—
	Fire	5575EO-F	—	5575NL-F	—
	Ctr. line	—	—	—	—
Concealed vertical rod lock	Panic	5547EO/5547WDC-EO	5547DT/5547WDC-DT	5547NL/5547WDC-NL	5547L/5547WDC-L
	Fire	5547EO-F /5547WDC-EO-F	—	5547 WDC-NL-F	5547L-F
Ctr. line	—	—	—	A 39 ¹³ / ₁₆ " (1011mm) B 40 ⁷ / ₁₆ " (1027 mm) for 5547L-F x 371L B 53 1/2" (1359 mm) for 5547L and 5547WDC-L-F	
Cylinder type required	Rim	—	—	Rim	Mortise
	Mortise	—	—	Mortise	Mortise
	C.V.R.	—	—	Rim	Mortise

Trim options

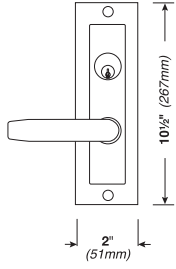
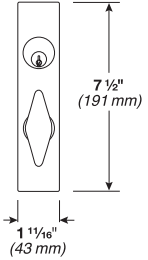
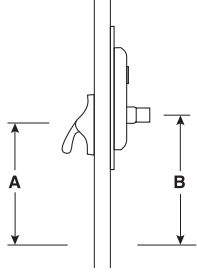
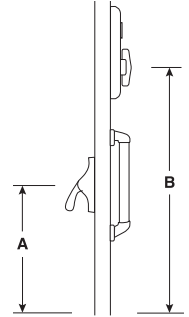
Function		08	11
		Key locks lever	Key locks thumbturn (pull required)
Trim number and dimensions		375-L 	376T x 550DT-5547/5547WDC 376T x 609DT - 5547F 
Device/trim center line to finished floor			
Projection		2 ⁵ / ₈ " (67 mm)	1 ¹³ / ₁₆ " (46 mm)
Rim	Panic	—	—
	Ctr. line	—	—
Mortise lock	Panic	5575L	—
	Fire	5575L-F	—
	Ctr. line	A 39 ¹³ / ₁₆ " (1011 mm) B 38 ¹ / ₂ " (978 mm)	
Concealed vertical rod lock	Panic	—	5547TL/5547WDC-TL
	Fire	—	5547TL-F/5547WDC-TL-F
	Ctr. line	—	A 39 ¹³ / ₁₆ " (1011 mm) B 53 ¹ / ₂ " (1359 mm)
Additional SNB requirements		2	2
Cylinder type required	Rim	—	—
	Mortise	—	—
	C.V.R.	Mortise	Mortise

55 Strike/Stile information

Device type	Standard single door		Standard double door		Optional single door		Optional double door	
	Strike	Stile	Strike w/mullion	Stile	Strike	Stile	Strike w/mullion	Stile
55 Rim	1409	1 ³ / ₄ " (44mm)	1408 x 5754	1 ³ / ₄ " (44mm)	299 1410 1606 264	2 ¹³ / ₁₆ " (71mm) 1 ³ / ₄ " (44mm) 2 ³ / ₈ " (60mm) 2 ⁹ / ₁₆ " (65mm)	299 x 5654 264 x 5654 1606 x 1654 299 x 4954 264 x 4954	2 ³ / ₄ " (70mm) 2 ¹ / ₂ " (64mm) 2 ³ / ₄ " (70mm) 3 ³ / ₁₆ " (81mm) 2 ¹⁵ / ₁₆ " (75mm)
5575	575	4 ³ / ₄ " (121mm)	—	—	—	—	575-2 576A-576B	4 ³ / ₄ " (121mm)
5575-F	575	4 ³ / ₄ " (121mm)	—	—	—	—	575-2 576A-576B	4 ³ / ₄ " (121mm)
5547	STRIKE		STILE		STRIKE		STILE	
	471U (Top) 304L (Bottom)		Single door	1 ⁷ / ₈ " (48mm)	472U/473U (Top) For wood frames		Single door	1 ⁷ / ₈ " (48mm)
			Two vertical rod devices	1 ³ / ₄ " (44mm)			Two vertical rod devices	1 ³ / ₄ " (44mm)
Vertical rod w/mortise lock device			4 ³ / ₄ " (121mm)	Vertical rod w/mortise lock device			4 ³ / ₄ " (121mm)	
5547WDC	338 (Top) 304L (Bottom)		Single door	4" (127mm)	472U/473U (Top) For wood frames		Single door	4" (127mm)
		Two vertical rod devices	4" (127mm)	Two vertical rod devices		4" (127mm)		
5547-F	Soffit Latch (Top) 301L (Bottom)		Two vertical rod devices	4 ³ / ₄ " (121mm)	385A (Bottom)		Vertical rod w/mortise lock device	4 ³ / ₄ " (121mm)
			Vertical rod w/mortise lock device	4 ³ / ₄ " (121mm)				
5547WDC-F	338 (Top) 304L (Bottom)		Two vertical rod devices	4" (127mm)	472U/473U (Top) For wood frames		Two vertical rod devices	4" (127mm)

55 Strike/Stile information

Strike application/Minimum stile

Strikes for rim devices

<p>264</p> <p>Projection $\frac{9}{16}$" (14mm)</p>	<p>299</p> <p>Projection $\frac{15}{16}$" (21mm)</p>	<p>1408</p> <p>One per pair of doors</p>	<p>1409 – Blade stop</p> <p>One per pair of doors</p>
<p>1410 – Integral stop</p> <p>Projection $\frac{1}{2}$" (13mm)</p>	<p>1606</p> <p>Projection $\frac{3}{8}$" (10mm)</p>	<p>1609 For rim/vertical rod consult factory - panic only</p>	

Strikes for vertical rod devices

<p>301L</p> <p>Mortise $\frac{3}{4}$" (19mm)</p>	<p>304L</p> <p>Mortise $\frac{13}{16}$" (21mm)</p>	<p>338</p> <p>Projection $\frac{5}{8}$" (16mm)</p>	<p>385A</p> <p>Mortise $2 \frac{1}{2}$" (64mm)</p>
<p>471U</p> <p>Hollow metal frame</p>	<p>472U</p> <p>Wood frame $1 \frac{3}{4}$" (44mm) thick doors - surface mounted</p>		<p>473U</p> <p>Wood frame $2 \frac{1}{4}$" (57mm) thick doors - surface mounted</p>

Strikes for mortise devices

<p>575</p> <p>For use on $\frac{13}{16}$" (44mm) or $2 \frac{1}{4}$" (57mm) Single door and $2 \frac{1}{4}$" (57mm) double door with coordinator.</p>	<p>575-2</p> <p>For use on $\frac{13}{16}$" (44mm) thick double door with coordinator and astragal</p>	<p>576A</p> <p>Open back strike for $\frac{13}{16}$" (44mm) thick double doors without coordinator.</p>	<p>576B</p> <p>Open back strike for $2 \frac{1}{4}$" (57mm) thick double doors without coordinator.</p>
<p>– Not for use with astragals – For use on wood doors, contact door manufacturer</p>		<p>– Acceptable for 90 minute pair of hollow metal doors</p>	

55 Electrical options

E5575 Electric mortise lock device



The E5575 electric mortise lock device has all the versatility and advantages of the 5575 mortise lock device, plus the advantage of being electrically controllable by a remote switching device, an access control or automatic device, or an automatic fire alarm system. The E5575 feature controls the locking of the outside trim. When unlocked, the door remains latched, preserving the fire rating of the door and making it particularly useful where codes permit locking, but require unlocking during a fire emergency.

Standard features:

- Field reversible mortise lock
- 24 VDC continuous duty solenoid
- Tamper resistant (auxiliary dead latch)
- Silent operation
- Corrosion resistant
- Signaling functions
- Key mechanically retracts latchbolt

Optional features:

- Fail safe (locked when energized, unlocked when de-energized or during power failure, specify with suffix "FS").
- Fail secure (unlocked when energized — specify with suffix "FSE"). Outside trim automatically relocks, unless held unlocked electrically.
- 24 VAC (by adding SO option).
- 12 VDC or 12 VAC with SO option.

To order, specify:

- 1a. E5575 or E5575F.
- 1b. E7500 (if lock only is required).
2. FS or FSE.
3. Voltage.
4. Handing, LHR or RHR
5. Outside trim. "L-BE" function only. When using with "L" function, no cylinder operation is available. Outside control is furnished "BE".

E - Electric unlocking of outside trim (BE only)

Available in Fail Secure (FSE) or Fail Safe (FS) options. 24VDC furnished as standard, 12 VDC available.

To order, specify:

1. E prefix:
 - E371L-BE / E376L-BE = for use with concealed vertical rods
 - E376WDC-L-BE = for use with wood door concealed devices
 - E379L-BE = for use with rim devices
2. FS or FSE
3. Voltage
4. Handing, LHR or RHR

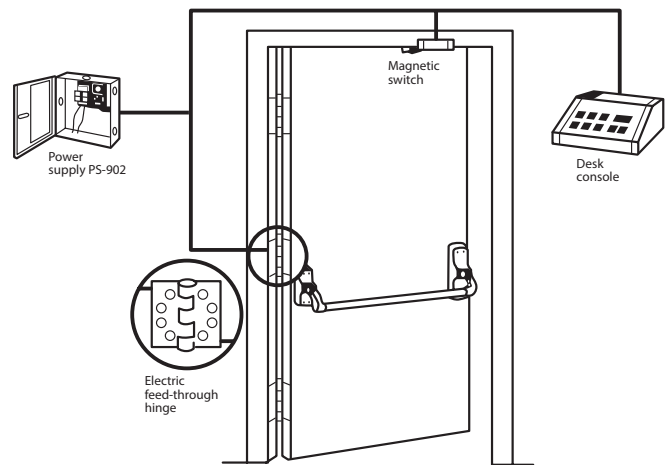

Adaptable for openings where continuous latching is required while the trim may be electrically locked or unlocked from a remote location — stairwells, exterior doors, etc.

Device options & accessories

Cylinders

Cylinders are not furnished with device or trim and must be specified when ordering. Rim and concealed vertical rod exit devices use rim type cylinders. Mortise lock exit devices and series 370 controls use mortise type cylinders.



Mortise — 3215 (Schlage 20-001, B502-191 cam)

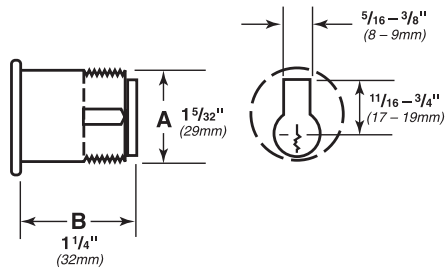

Rim — 3216 (Schlage 20-022 cam)

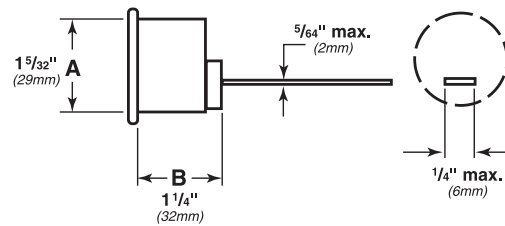

Conversion kit — NL

NL Kit is used for converting 55DT or 55EO to 55NL for night latch function. Kit includes NL cam only.

The 55DT trim, 3216 rim cylinder, and 110NL/MD/WDC cylinder assemblies must be ordered separately.

Dogged (inverted) cam

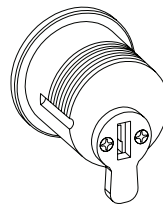

For cylinder dogging
Special dogging

Undogged cam (standard operations)

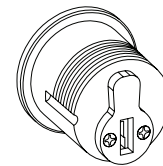

Undogged cam
(standard operations)

Additional information

UL Listed — Fire exit hardware label/opening size

Exit device	Single door	Double door		
		Same direction vert./vert.	Same direction vert./mortise	Double egress
5575-F	3 Hour 4' x 10'	—	3 Hour 8' x 8'	—
5547-F	—	90 Min. 8' x 8'	3 Hour 8' x 8'	3 Hour 8' x 8'
5547-F-WDC	—	90 Min. 8' x 9' 3"	—	—

ANSI Function, grade & type

Function	Grade 1, type 4	Grade 1, type 3 & 10	Grade 1, type 6 & 8
01	55EO	5575EO 5575EO-F	5547EO/5547WDCEO/F 5547EO-F
02	55DT	5575DT/F	5547DT/5547WDCDT/F
03	55NL	5575NL 5575NL-F	5547NL/5547WDCNL/F
08	55L	5575L	5547L-F/5547EDCL/F
11-12	—	—	5547TL 5547TL-F
11-12	—	—	5547TL-WDC 5547TL-WDC-F

55 Series finishes

Finishes*

	Color	US Number	BHMA Number
	Chromium, polished	US26	625
	Chromium, dull	US26D	626
	Brass, polished	US3	605
	Brass, dull	US4	606
	Bronze, dull	US10	612
	Bronze, dull-oxidized	US10B	613

Special finishes

	Color	US Number	BHMA Number
	Brass, polished	US3A	605
	Brass, dull	US4A	606
	Aged bronze	643E	
	Sprayed black	SPBLK	

* **Note:** Durable powder coated finishes available at specific special request. PLEASE CONTACT FACTORY.

Notes

Notes

About Allegion

Allegion (NYSE: ALLE) is a global pioneer in safety and security, with leading brands like CISA®, Interflex®, LCN®, Schlage®, SimonsVoss® and Von Duprin®. Focusing on security around the door and adjacent areas, Allegion produces a range of solutions for homes, businesses, schools and other institutions. Allegion is a \$2 billion company, with products sold in almost 130 countries.

For more, visit www.allegion.com

KRYPTONITE ■ LCN ■  ■ STEELCRAFT ■ VON DUPRIN