



UT5200 Series

Unit Locksets

Product Catalog

Experience a safer
and more open world

Features

Handing

Specify hand. All functions are handed.

Door Thickness

1-3/4" (44mm) only.

Backset

2-3/4" (70mm) only.

Lock Chassis

One-piece investment cast frame. Machined internal parts of steel, bronze and stainless steel. Zinc dichromated for corrosion resistance.

Front

Beveled 1/8" (3mm) in 2" (51mm).

Latchbolt

Brass, chrome plated, 3/4" (19mm) throw pivoted, swinging type.

Auxiliary Latch

Deadlocks latchbolt, preventing manipulation when door is closed.

Strike

Wrought brass or bronze, ANSI strike with nylon adjusting screw, standard. 4-7/8" (124mm) x 1-1/4" (32mm) x 1-1/4" (32mm) lip to center. Optional strikes and lip lengths available; see pages 6 and 9.

Cylinder

Brass, 6-pin, L4 keyway, 0-bitted standard.

Keys

Two nickel silver standard.

Keying Features Available

- Master keying
- Construction master keying
- Visual key control
- Concealed key control
- Interchangeable core (IC)
- Security
- Security (IC)
- Access 3™
- Pyramid High Security
- Pyramid High Security (IC)
- Pyramid Security
- Pyramid Security (IC)
- Master ring

Warranty

One-year limited.

MicroShield®

UT5200 series locks are available with MicroShield® antimicrobial coating. *MicroShield* is a revolutionary hardware finish coating, using a silver ion based technology, which inhibits the growth of bacteria, algae, yeast, fungus, mold and mildew. *MicroShield* is non-toxic and lasts for the lifetime of the finish to which it is applied. To order, suffix option code "C".

Note: MicroShield® coating may vary finish color from architectural standards. *MicroShield* is not intended as a substitute for traditional infection control programs such as hand hygiene or use of disinfectants. Coated product must still be cleaned to insure the surfaces will be free of destructive microbes. Corbin Russwin makes no representations or warranties, express or implied, as to the efficacy of the *MicroShield* antimicrobial.

Certification/Compliance

ANSI/BHMA

Designed to meet A156.2 Series 2000. Meets A117.1 Accessibility Code (lever design only).

Federal

Meets FF-H-106C.

California State Reference Code

(Formerly Title 19, California State Fire Marshal Standard)

All levers with return comply; levers return to within 1/2" (13mm) of door face.

UL-cUL

All locks listed for A label and lesser class doors, single or pair, maximum door size 3'8" (111.7cm) x 7'2" (218.4cm) All locksets also listed for B label doors, single or pair, maximum door size 4' x 8'. Letter F and UL symbol on lock frame indicate listing.

Any retrofit or other field modification to a fire-rated opening can potentially impact the fire rating of the opening, and Corbin Russwin, Inc. makes no representations or warranties concerning what such impact may be in any specific situation. When retrofitting any portion of an existing fire-rated opening, or specifying and installing a new fire-rated opening, please consult with a code specialist or local code official (Authority Having Jurisdiction) to ensure compliance with all applicable codes and ratings.

Finishes

612	US10	Satin Bronze
613	US10B	Dark Oxidized Satin Bronze, Oil Rubbed
613E	—	Dark Oxidized Satin Bronze - equivalent
625	US26	Bright Chromium Plated
626	US26D	Satin Chromium Plated
626C	—	Satin Chromium Plated with MicroShield®

Precision machined internal parts ensure smooth operation an long life

Installation of preassembled lockset requires only tightening three through bolts, significantly reducing costs and potential for error

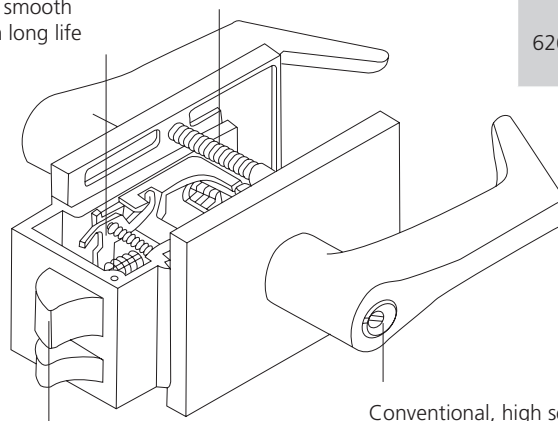

3/4" throw latchbolt provides security and meets all force-to-latch requirements

Conventional, high security, interchangeable core and master ring cylinders available for keying flexibility

Functions

UT5200 Series

Outside	Inside	Series/Function	Type	ANSI No.	Function Description
		UT5210	Passage or Closet	F36	<ul style="list-style-type: none"> Latchbolt by grip either side. Both grips always free.
		UT5220	Privacy Bedroom or Bathroom	F37	<ul style="list-style-type: none"> Latchbolt by grip either side. Outside grip locked by push button. Outside grip unlocked by emergency release tool outside, by rotating inside grip or by closing door. Inside grip always free.
		UT5251	Entrance or Office	F40	<ul style="list-style-type: none"> Deadlocking latchbolt by grip either side, except when turn button locks outside grip. Key outside retracts latchbolt. Outside grip unlocked by turn button. Inside grip always free.
		UT5255	Classroom	F42	<ul style="list-style-type: none"> Deadlocking latchbolt by grip either side, except when key outside locks outside grip. Outside grip unlocked by key outside. Inside grip always free.
		UT5257	Storeroom or Closet	F44	<ul style="list-style-type: none"> Deadlocking latchbolt by key in outside grip or by rotating inside lever. Outside grip always rigid. Inside grip always free.
		UT5282	Store Door	F46	<ul style="list-style-type: none"> Deadlocking latchbolt by grip either side, except when key either side locks both grips. Keyed alike unless specified otherwise.

Indicates optional interchangeable core available; see How to Order, page 9.

Indicates rigid grip.

Trim Designs

UT5200 Series

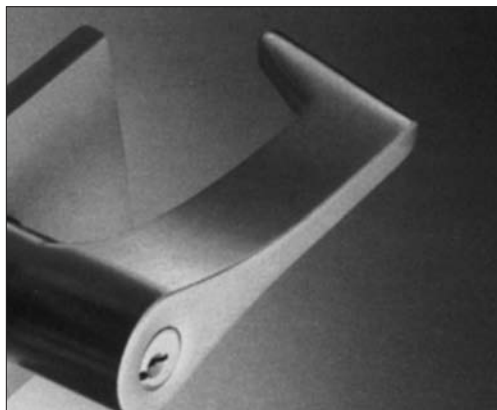

Essex

Complies with codes requiring lever to return to within 1/2" (13mm) of door face.

Brass.

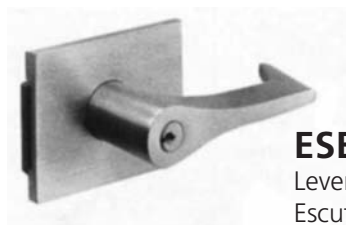

ESE

Lever: Forged
Escutcheon: Forged

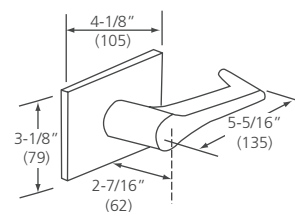

Options and Accessories

UT5200 Series

Cylinders

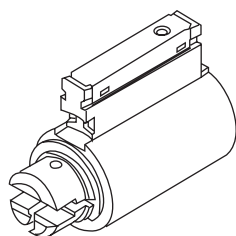

Standard Cylinder
 .552" plug diameter
 Brass, 6-pin
 2 nickel silver keys
 Finishes: 606, 626
 .496" plug diameter Pyramid

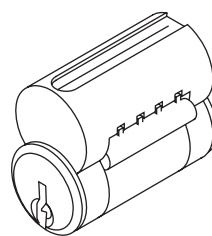

Interchangeable Core
 .509" plug diameter conventional
 .552" plug diameter high security
 Brass, 6-pin
 2 nickel silver keys
 Finishes: 612, 613, 613E, 625, 626
 .496" plug diameter Pyramid

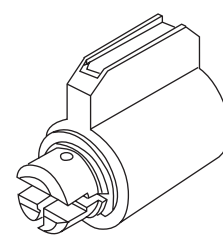

Master Ring Cylinder
 .552" plug diameter
 Brass, 6-pin
 2 nickel silver keys
 Finishes: 606, 626

Conventional 6-Pin	2000-052	8000	2060-052
Conventional 7-Pin	N/A	8000-7	N/A
Security	2010-052	8010	N/A
Pyramid High Security	2020-052	8020	N/A
Pyramid Security	2027-052	8027	N/A
Access 3 - Patented (AP)	2500-052	8500	N/A
Access 3 - Security (AS)	2600-052	8600	N/A
Access 3 - High Security (AHS)	2700-052	8700	N/A

To order optional cylinder with lockset, see How to Order, page 9.

To order cylinder separately, specify Part No. x Keyway x Finish) (e.g., 2000-052 x L4 x 626).

How to Order

UT5200 Series

Cylinder and Keying

Description	Specify
Conventional 6-pin	(standard)
Less cylinder(s)	LC
IC 6-pin	C6
IC 6-pin less core	CL6
IC 7-pin (ESE trim only)	C7
IC 7-pin less core (ESE trim only)	CL7
High Security	HS
High Security IC	CHS
Master ring	MR
0-bitted with 2 blank keys	(standard)
Keyed random	KR
Construction master keyed	CMK
Access 3® Patented Fixed Core	AP
Access 3® Security Fixed Core	AS
Access 3® High Security Fixed Core	AHS
Access 3® Patented IC3	ACP
Access 3® Security IC3	ACS
Access 3® High Security IC3	ACHS
Pyramid Security Fixed Core	PS
Pyramid Security IC	PCS
Pyramid High Security Fixed Core	PHS
Pyramid High Security IC	PCHS
Pyramid IC with Temporary Construction Core	CTP
Pyramid IC with Temporary Disposable Core	CTPD
Pyramid IC Less Core	CLP
IC 6-pin with Temporary Construction Core (Red)	CT6R
IC 6-pin with Temporary Construction Core (Blue)	CT6B
IC 6-pin with Temporary Construction Core (Green)	CT6G
IC 6-pin with Temporary Disposable Core	CT6D
IC 7-pin with Temporary Construction Core (Red)	CT7R
IC 7-pin with Temporary Construction Core (Blue)	CT7B
IC 7-pin with Temporary Construction Core (Green)	CT7G
IC 7-pin with temporary Disposable Core	CT7D
No Stamping	VKC0
Keys only	VKC1
Cylinders and keys (not for HS or CHS)	VKC2
Cylinders only (not for HS or CHS)	VKC3
Concealed key control (CKC)	
CKC cylinders with VKC keys	CKC2
CKC cylinders only	CKC3
2 keys per lock	(standard)
More than 2 keys	KY# (e.g., KY6)

Strikes

Lip Length	ANSI Curved Lip Specify	T-Strike Curved Lip Box* Specify
1-1/4" (32mm)	(standard)	N/A
2" (51mm)	N/A	SC200
2-1/8" (54mm)	N/A	SC218
2-1/4" (57mm)	N/A	SC214
2-1/2" (64mm)	N/A	SC212
2-3/4" (70mm)	N/A	SC234
3" (76mm)	N/A	SC300
Lip Length	ANSI* Straight Lip for Door Pair Specify	For Door Pair* Specify
1-13/16" (46mm)	SA136	SP136
Lip Length	ANSI Straight Lip for Extended Lip Escutcheon	For Extended Lip Escutcheon
15/16" (24mm)	Standard when extended lip escutcheon option is specified	SX156

*Lip is measured from back of strike

Miscellaneous Options

Description	Specify
Spanner head screws	M02
Lever to accept SFIC core	M08
Extended lip escutcheon (for single door reverse bevel; 630 finish to match 626 only)	M11
Knurling outside and inside	M20
Knurling outside only	M21
Knurling inside only	M22
Abrasive coat outside and inside	M23
Abrasive coat inside only	M24
Abrasive coat outside only	M25
Lead-lined escutcheon (inside only)	M28
Unstaked lever retainer	M33
MicroShield Coating (626C only)	C

Finish

Description	Specify
US10 Satin Bronze	612
US10B Dark Oxidized Satin Bronze, Oil Rubbed	613
— Dark Oxidized Satin Bronze - equivalent	613E
US26 Bright Chromium Plated	625
US26D Satin Chromium Plated	626
— Satin Chromium Plated with MicroShield®	626C

Handing

Hand	Specify
Right Hand	RH
Left Hand	LH
Right Hand Reverse	RHR
Left Hand Reverse	LHR