



**Safety Technology
International, Inc.**

UB-1 Universal Button

UB-1/LTUL Universal Button with Latching Timer



**ADA
Compliant**

For UB-1/LTUL the enclosed timer is to be used and installed per the enclosed LT-1UL installation sheet. For access control installations, power for the LT-1UL Timer must be supplied by a power source listed to UL294. When used for access control, this device shall be used as part of an access controlled egress door system. It is up to the local AHJ to allow use of this device in place of an automatic sensor. For higher security installations, lower time limits should be used.

Pour les modèles UB-1/LTUL, la minuterie intégrée doit être installée et utilisée suivant la fiche d'installation LT-1UL fournie. Pour les installations de contrôle d'accès, l'alimentation de la minuterie LT-1 doit être fournie par une source homologuée UL294. Lorsque cet appareil est utilisé aux fins de contrôle d'accès, il doit faire partie d'un système de porte de sortie à accès contrôlé. Il incombe donc à l'AHJ local d'autoriser l'utilisation de cet appareil au lieu d'un capteur automatique. Pour les installations de sécurité plus renforcée, des délais inférieurs doivent être utilisés.

We protect the things that protect you.®

NOTES

It is important to read, understand and follow all instructions provided with this product. It is the installer's responsibility to comply with NFPA 70 & 101, NEC, mounting specifications according to ADA and other applicable electrical codes. For Type SM (Self Monitored) rating, the term Emergency message may be installed on Model UB-1 when used in a system with a Listed, compatible Releasing Device. All other applications are rated Type NM (Non-Monitored) for non-emergency signaling. To avoid electrical shock, DO NOT attempt to install this product when power is on. ADA mounting compliance requires the operable part of the initiating device shall not be less than 3 1/2 ft. (1.1 m) or greater than 4 1/2 ft. (1.37m) above finished floor surface. After installation and testing are complete, provide a copy of this manual to all personnel responsible for testing and maintenance of this product.

REMARQUES

Il est important de lire, de comprendre et de suivre toutes les instructions fournies avec ce produit. Il incombe à l'installateur de se conformer aux normes NFPA 70 et 101, NEC, aux spécifications de montage selon l'ADA et aux autres codes de l'électricité en vigueur. Pour les cotes de type SM (auto surveillée), le message d'Urgence peut être apposé sur le modèle UB-1 lorsqu'il est utilisé dans un système intégrant un dispositif de déclenchement compatible et homologué. Toutes les autres applications sont cotées de Type NM (non surveillée) pour la signalisation non urgente. Pour éviter un choc électrique, NE tentez PAS d'installer ce produit lorsqu'il est sous tension. La conformité aux règles d'installation de l'ADA exige que la partie utilisable du dispositif de déclenchement soit installée à une hauteur située entre 3 1/2 pi (1,1 m) et 4 1/2 pi (1,37 m) au-dessus du plancher fini. Une fois l'installation et les essais terminés, vous devez fournir une copie de ce manuel à l'ensemble du personnel chargé de l'essai et de l'entretien de ce produit.

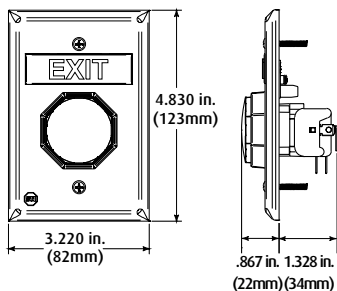

SWITCH RATING

2 Momentary Independent Form "C" contacts

UB-1/rated at: 10A, 1/2 HP, 125/250 VAC

6A, 30 VDC

100,000 Operations

Temperature: -40° to 185°F (-40° to 85°C)

Model UB-1/LTUL

Form C contacts on

Timer rated:

30 VDC 3A, 1.0 pf

1. TO CHANGE BUTTON COLOR AND ROUND MESSAGE

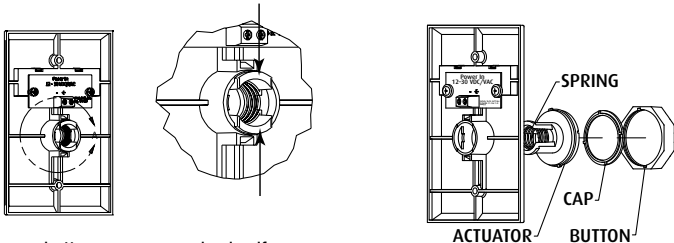

1. Choose button message and color. If same as existing, proceed to **2**.
2. To remove push button actuator assembly, pinch together actuator tabs in direction of arrows shown above and push through plate.
3. Push actuator through plate.
4. Align actuator cap to push button actuator. Align button slots to tabs on push button actuator.
5. Snap button onto push button actuator and rotate right to lock.
6. Insert spring into push button actuator.
7. Pinch legs of push button actuator and align into die cast plate.

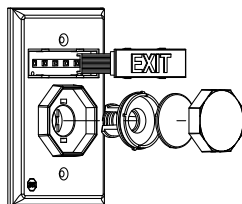

2. CHANGE TOP MESSAGE

Refer to notes on pg. 2 for “EMERGENCY” message use.

1. Remove LED circuit board.
2. Remove current message by pushing in and down on tabs 1 and 2 with a small screwdriver. If necessary, also push in and down on tabs 3 and 4. Once message is loose, remove from the front of the plate.
3. Select new message and snap into place. Blank plates are included to create your own custom message.

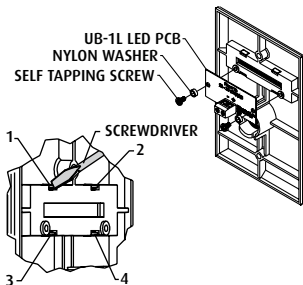

3. INSTALL OR REMOVE CONTACT BLOCK

INSTALL

To attach, align tabs (as shown) and gently snap **top**, **then bottom**. Be sure to hear BOTH tabs snap into place. (Can be reversed if wiring comes from the top of the box.)

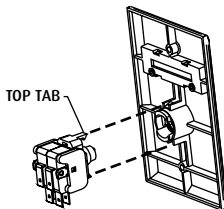

REMOVE

Repeat **STEP A** for the **top and bottom tab** before removing contact block.

Step A: Position small flat screwdriver blade under tab and gently rotate until tab disengages. The contact block will rotate a little. Do NOT pull yet.

Step B: Repeat for opposite tab.

Step C: When both tabs are disengaged, pull the contact block straight off.

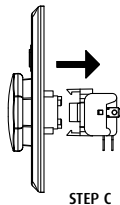
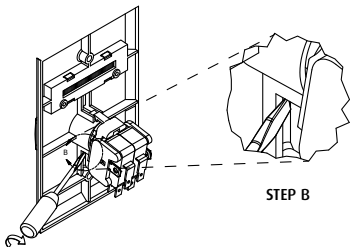
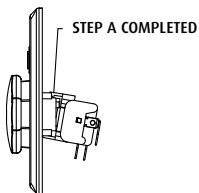
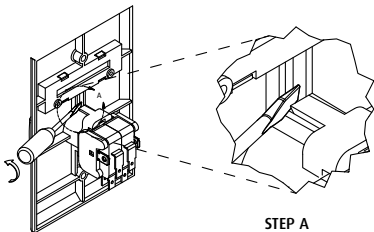

4. ATTACH POWER FOR MESSAGE LED (if desired)

(See drawing)

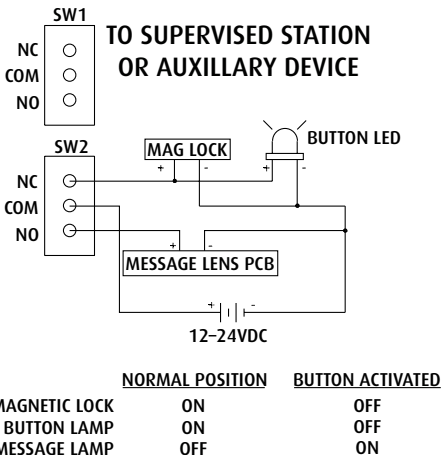

NOTE

LED connection: The polarity shown is factory installed. LED is polarity sensitive. If LED does not light, switch positive and negative wiring or remove LED and rotate 180°. 24 volt is included and will operate on 12 volts; however not as bright. 12 volt LED's are also available.

5. SURFACE MOUNT OPTION

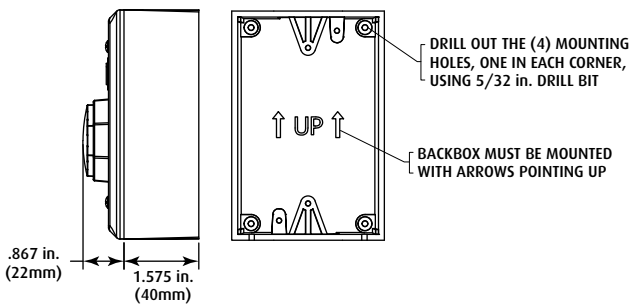
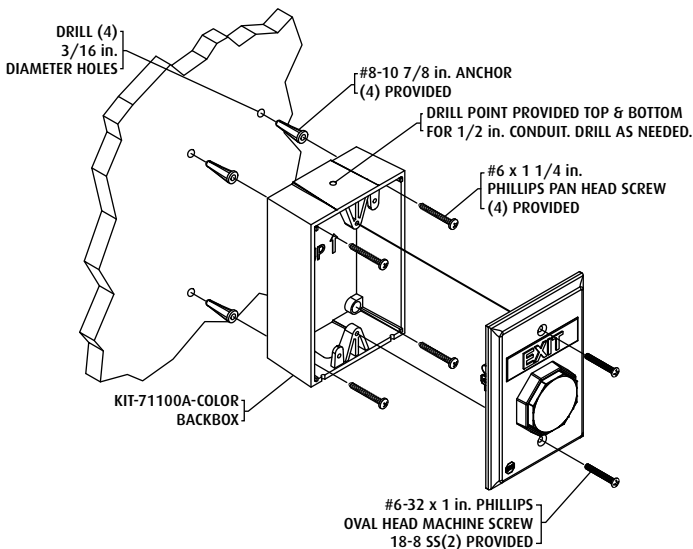

6. MOUNT BUTTON ONTO ELECTRICAL BOX OPTION

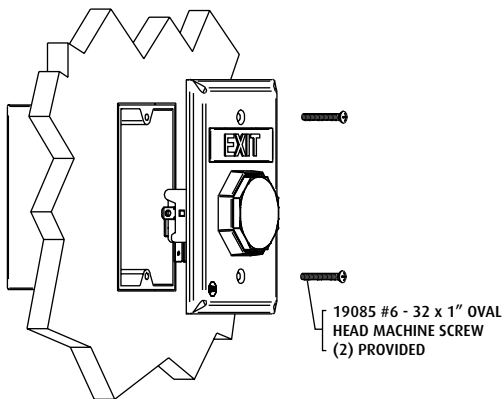

7. CUSTOM LABELS

To create your own custom label, size to fit in .48h x 2.23w as shown below.
Also available online at: www.sti-usa.com/ublabel

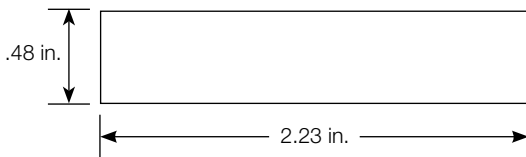

WARRANTY

Three year guarantee against breakage of polycarbonate in normal use (one year on electro mechanical and electronic components).

Electronic warranty form at www.sti-usa.com/wc14.

ACCESSORIES

PART #	DESCRIPTION
KIT-UB-1C KIT-71100A-COLOR (red, blue, green, white or yellow)	CONTACT BLOCK COLORMATCH BACKBOX KIT
UB-1CL-COLOR (blue, green, white or yellow)	CUSTOM LABEL APPLIED TO BLANK MESSAGE PLATES
E10147 E10145 E10141 E10143	24 VOLT LED WHITE (STANDARD) RED BLUE GREEN
E10144 E10140 E10142	12 VOLT LED RED BLUE GREEN
STI-6518 STI-13000 SERIES STI-1100 SERIES	COVERS BOPPER STOPPER UNIVERSAL STOPPER STOPPER II

- SEE WEBSITE FOR COMPLETE COVER DETAILS -



**Safety Technology
International, Inc.**

2306 Airport Rd • Waterford, MI 48327, USA
Phone: 248-673-9898 • Fax: 248-673-1246
info@sti-usa.com • www.sti-usa.com

Safety Technology International Ltd

Taylor House • 34 Sherwood Road • Bromsgrove
Worcestershire • B60 3DR • England • Tel: +44 (0)1527 520 999
Fax: +44 (0)1527 501 999 • info@sti-europe.com • www.sti-europe.com