



B500 Series

Grade 2 Deadbolt

OVERVIEW

The B500 Series deadbolt from Schlage offers some of the toughest, most versatile Grade 2 deadbolts in the business. Designed by locksmiths for locksmiths, B500 Series can accept every Schlage cylinder format and fit virtually every door you service. It features enhanced lock strength on the jamb side of the door and is offered in most functions with optional single- or dual-sided lock status indicator trim options. Large window size and Schlage's patented 180-degree visibility will change forever the way you look at deadbolts.

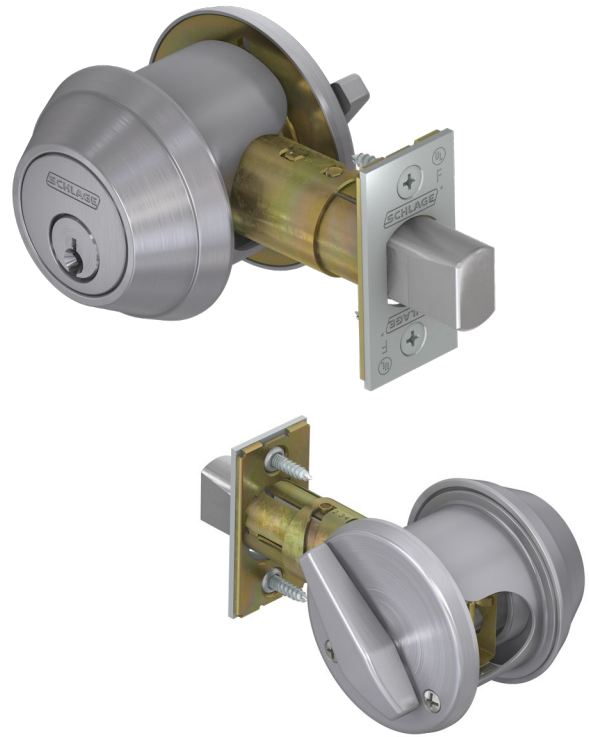

FINISHES



605
Bright Brass



606
Satin Brass

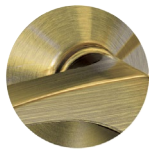

609
Antique Bronze



612
Satin Bronze



613
Oil Rubbed
Bronze

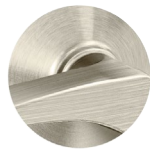

619
Satin Nickel



622
Matte Black



625
Bright Chrome

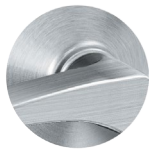

626
Satin Chrome

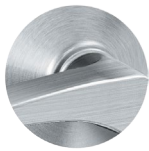

626AM
Satin Chrome
Antimicrobial



643e
Aged Bronze

e = an equivalent finish to the BHMA standard.



INDICATORS

Inside Trims



Thumbturn



Key cylinder

Outside Trims



Coin turn



Key cylinder

Available Messages

	LOCKED	OCCUPIED
	UNLOCKED	VACANT
Inside trim	IS-LOC	IS-OCC
Outside trim	OS-LOC	OS-OCC
Inside trim (Française)	IS-LOCFR	IS-OCCFR
Outside trim (Française)	OS-LOCFR	OS-OCCFR

Note: Spanish language options available via RFQ.

DIMENSIONS

Standard Trim

Conventional Key Cylinder

Thumbturn side		Cylinder side	
Rose diameter	2.57"	Trim ring diameter	2.54"
Projection	0.78"	Projection	0.59"

FSIC/SFIC Key Cylinder

Thumbturn side		Cylinder side	
Rose diameter	2.57"	Trim ring diameter	2.54"
Projection	0.78"	Projection	0.89"

Indicator Trim

Conventional/FSIC/SFIC Key Cylinder

Escutcheon		Projection	
Height	4.125"	Thumbturn side	0.92"
Width	2.54"	Cylinder side	1.28"

LOCK FUNCTIONS

Legend

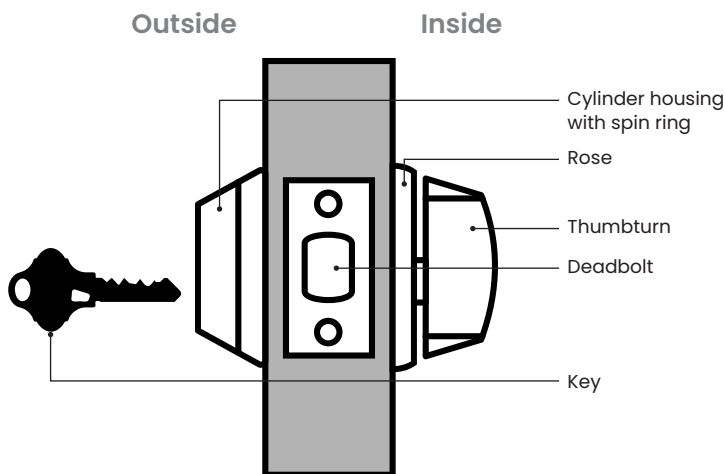

Key



Inside lock status indicator available



Outside lock status indicator available

Product Identification Guide

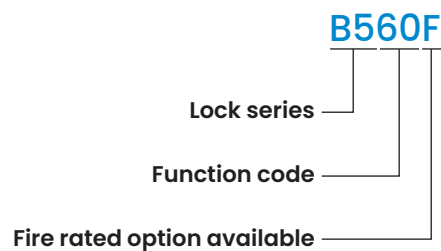

LOCK FUNCTIONS

Schlage
B560/B560F

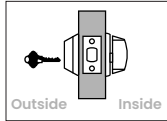

- Key cylinder outside; thumbturn inside
- Deadbolt thrown or retracted by key outside or thumbturn inside
- When installed with optional lock status indicator trim, in unlocked state message displays on white background; in locked state on red background

To order configured with indicator specify function and note indicator code as a special option

ANSI
E0152



Schlage
B561/B561F

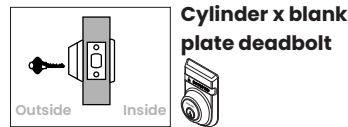
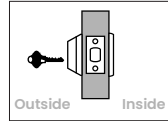

- Key cylinder outside; blank plate inside
- Deadbolt thrown or retracted by key outside
- When installed with optional lock status indicator trim, in unlocked state message displays on white background; in locked state on red background

To order configured with indicator specify function and note indicator code as a special option.

ANSI
E0162

Schlage
B562

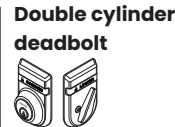
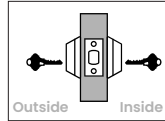

- Key cylinder both sides
- Deadbolt thrown or retracted by key from either side
- When installed with optional lock status indicator trim, in unlocked state message displays on white background; in locked state on red background

Caution: Double cylinder locks on any door, in any structure which is used for egress are a life safety hazard in times of emergency and their use is not recommended. Installation should be in accordance with existing codes only.

Note: This function cannot be ordered UL 10C fire rated.

To order configured with indicator specify function and note indicator code as a special option.

ANSI
E0142

Schlage
B563/B563F

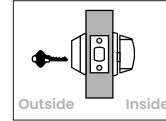

- Key cylinder outside; thumbturn inside
- Deadbolt thrown or retracted by key outside
- Thumbturn inside can only retract deadbolt
- When installed with optional lock status indicator trim, in unlocked state message displays on white background; in locked state on red background

To order configured with indicator specify function and note indicator code as a special option.

ANSI
E0172

Schlage
B572/B572F

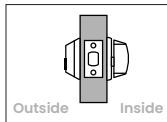

- Coin turn outside; thumbturn inside
- Deadbolt thrown or retracted by thumbturn inside
- A flat screwdriver inserted in the coin turn outside can also retract deadbolt
- When installed with optional lock status indicator trim, in unlocked state message displays on white background; in locked state on red background

To order configured with indicator specify function and note indicator code as a special option.

ANSI
-

Schlage
B580/B580F

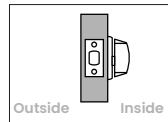

- No outside trim; thumbturn inside
- Deadbolt thrown or retracted by thumbturn inside

Note: 1-1/2" bore only.

ANSI
E0192

Schlage
B581/B581F

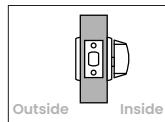

- Blank plate outside; thumbturn inside
- Deadbolt thrown or retracted by thumbturn inside
- When installed with optional lock status indicator trim, in unlocked state message displays on white background; in locked state on red background

To order configured with indicator specify function and note indicator code as a special option.

ANSI
E01112

CYLINDERS

Conventional cylinder

P6	6-pin cylinder (default) with Schlage logo
P	6-pin cylinder, keyed 5
Z	Everest SL cylinder, 7-pin (A2 pinning) with Schlage logo
L	Less conventional cylinder

Full size interchangeable core (FSIC)

R	6-pin FSIC with Schlage logo
M	Everest SL FSIC, 7-pin (A2 pinning) with Schlage logo
J	Less FSIC
T	Refundable FSIC construction core

Small format interchangeable core (SFIC)

G	7-pin SFIC (A2 pinning) with Schlage logo
B	Less SFIC
BDC	Disposable SFIC construction core
H	Refundable SFIC construction core

SPECIFICATIONS

Trim	
Material	Solid zinc cylinder housing; 1" standoff wrought brass or bronze trim ring over solid zinc spin ring.
Door thickness	Standard: 1-3/8" to 1-7/8" conventional cylinder or thumbturn only; 1-5/8" to 2" interchangeable core cylinder.

Deadbolt	
Backset	Adjustable for 2-3/8" or 2-3/4".
Faceplate	1" x 2-1/4", Square corner faceplate standard. Options available.
Bolt	Solid zinc bolt with hardened steel anti-saw pin insert; 1" housing diameter, 1" throw.
Strike	1-1/8" x 2-3/4", Square corner, metal box. Options available.

Keying	
Cylinder format	6-pin Conventional (standard); also available in FSIC, SFIC and 7-pin SL cylinder formats.
Keyway	Patented Everest 29 S123 (standard); also available in open, restricted, and Primus security levels with available master keying and construction keying.

Attachment	
	Three 3" screws anchor metal dustbox to frame. 1/4" machine screws through bolt to firmly anchor lock to door.

Warranty	
	3-year limited mechanical warranty. See price book for details.

Certifications	
ANSI/BHMA	ANSI A156.36, Grade 2. When installed with SFIC cylinder, Grade 3.
UL/cUL	Available UL Listed for 3-hour fire door (except B562)
Federal	BAA compliant, all functions.
Other	ADA compliant thumbturn.