

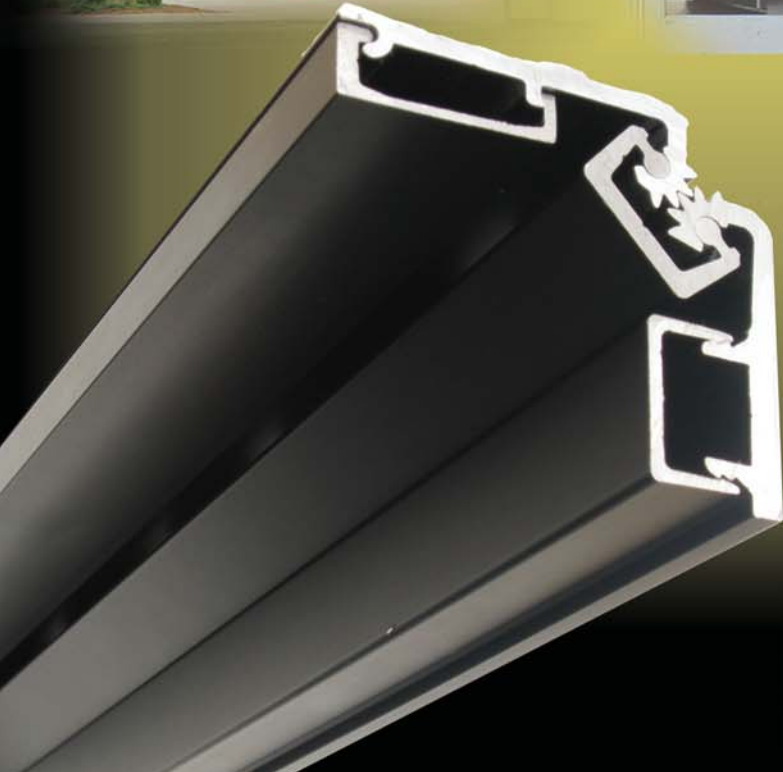

# CONTINUOUS HINGES

ALUMINUM GEAR

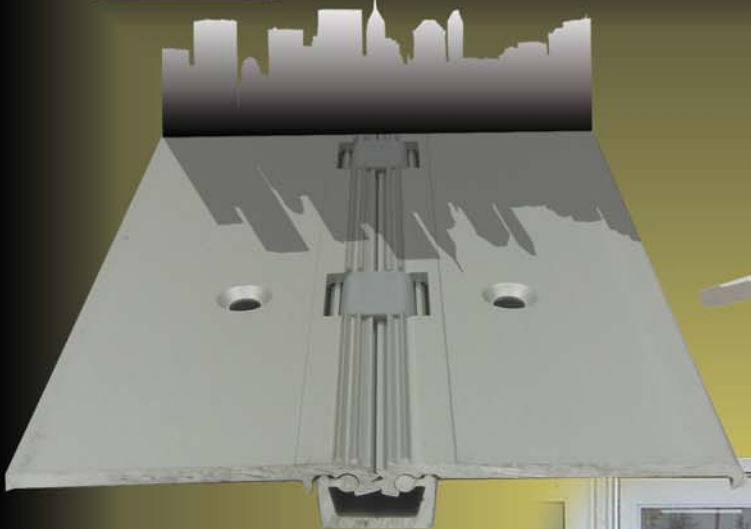



## INTRODUCTION

All PBB Continuous Gear Hinges are offered in standard duty or heavy duty sizes. There are no accessible screws, bolts or pins when the door is closed. PBB gear hinges are surface mount or concealed, the PBB continuous gear hinges eliminate the gap between the door and frame, and provide a weatherproof, tamper-proof barrier. PBB gear hinges are manufactured with state of the art maCGinery making eaCG unit true templated. Full concealed units are UL listed for 3 hour fire rated doors. Certified to fire rating standards UL10B, UL10C, and UBC 7.2 in the U.S. and Canada.

- Extruded 6063-T6 aluminum alloy
- Lifetime Lubrication
- 83", 85", 95", and 120" are standard. Other sizes available
- PBB continuous gear hinges are offered in 30 minute clear anodized and 2-step dark bronze anodized
- PBB gear hinges are non-handed unless cut in the field. When field cut, the hinge becomes handed
- #12-24 x 11/16" self drilling & tapping flathead Phillips undercut screws are standard for concealed hinges. Other screws available. Stainless steel or security fasteners furnished on request at an additional CGarge.
- PBB can provide any custom mounting hole location per customer specifications.

### TABLE OF CONTENTS

#### SPECIFICATIONS

CG31L Full Mortise 1/16" Inset	1
CG31PN Full Mortise 3/32" Inset	2
CG31I Full Mortise 1/8" Inset	3
CG31 Full Mortise Flush Mount	4
CG31P Full Mortise Flush Mount	5
CG31CL Swing Clear Full Mortise Flush Mount	6
CG33N Full Surface Narrow Frame	7
CG33C Full Surface Swing Clear	8
CG34N Half Surface Narrow Frame 3/32" Inset	9
CG34 Half Surface Narrow Frame 3/32" Inset	10

#### TEMPLATES

<b>CG31-CG31I-CG31L:</b> 79HD, 83SD, 83HD, 83LL	11
<b>CG31-CG31I-CG31L:</b> 85SD, 85HD, 85LL, 95SD	12
<b>CG31-CG31I-CG31L:</b> 95HD, 95LL, 120SD, 120HD	13
<b>CG31PN-CG31P:</b> 83LL, 85LL, 95LL, 120LL	14
<b>CG33N-CG33C:</b> 83SD&HD, 85SD&HD, 95SD&HD, 120SD&HD	15
<b>CG31CL:</b> 83HD, 83LL, 85HD, 85LL	16
<b>CG31CL:</b> 95HD, 95LL, 120HD, 120LL	17
<b>CG34N-CG34:</b> 83HD, 85HD, 95HD, 120HD	18

### INSTALLATION INSTRUCTIONS

CG31, CG31I, CG31L, CG31PN, CG31P	19-20	CG31CL	23-24
CG33C, CG33N	21-22	CG34N	25-26

### EPT | PT | CUTOUTS | ORDER FORMS

POWER TRANSFER (EP)	27	ELECTRICAL & ELECTRICAL MONITOR (E &EM)	29
DUTCG DOOR ORDER FORM	28	REMOVABLE & MOVABLE PANEL (R & M)	30



# CG31L HEAVY DUTY SERIES

## FULL MORTISE 1 1/16" INSET

Closed Position

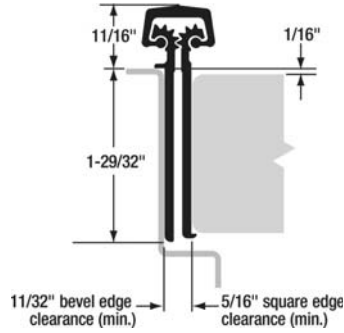

90° Open Position

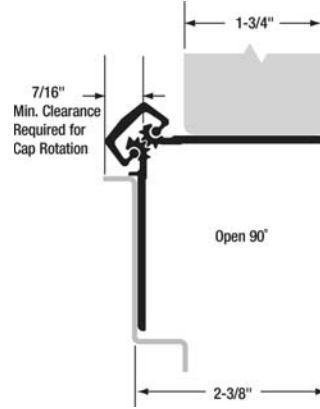

180° Open Position

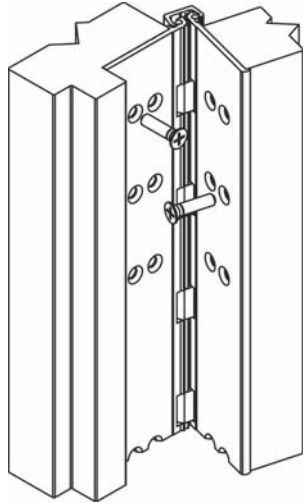
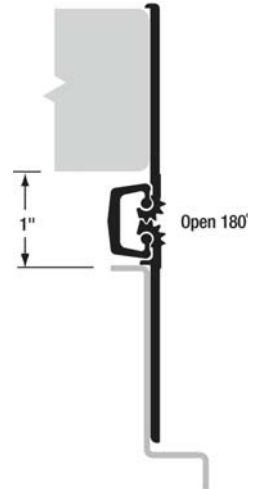

- ◆ For new construction
- ◆ For renovation with new doors and/or frames
- ◆ No mortising of doors or frames required
- ◆ Will cover butt hinge cutouts in old frames
- ◆ Material - Extruded 6063-T6 Aluminum Alloy w/ Polyester thrust bearings
- ◆ Can manufacturer hole sizes & locations per customers specs
- ◆ No door reinforcement required
- ◆ Over 200 lbs. reinforce frame with 16 Ga. Channel
- ◆ For 1 3/4" doors up to 450 lbs.
- ◆ 1/16" door inset
- ◆ LL for doors up to 1000 lbs
- ◆ Door Edge Protector
- ◆ Template and hole pattern is same from hinge to hinge
- ◆ 83" can be field cut to 79" without cutting thru a bearing or mounting holes
- ◆ Hinge is non-handed unless cut in the field
- ◆ UL listed for 90 minute rated doors
- ◆ Can be UL listed for up to 3 hours

PBB Model Number	Length		Screw Count		LL Screw Count	
	Inches	Centimeters	Door	Jamb	Door	Jamb
CG31L83	83"	210.8	19	19	26	26
CG31L85	85"	215.9	19	19	26	26
CG31L95	95"	241.3	21	21	30	30
CG31L120	120"	304.8	23	23	34	34

628 - CLEAR ANODIZED - US28

710 - DARK ANODIZED - US10B

Full Mortise Fasteners-	
<p><b>Screw Pack A</b> #12-24 x 1/2" Phillips Flat Head Undercut Thread Forming Screws</p>	



# CG31PN HEAVY DUTY SERIES

## FULL MORTISE 3/32" INSET

Closed Position

90° Open Position

180° Open Position

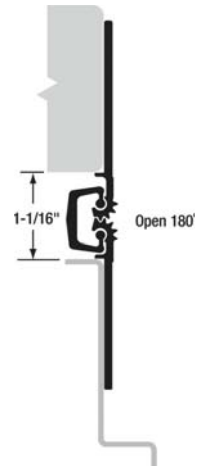
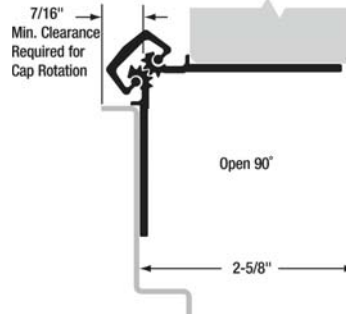
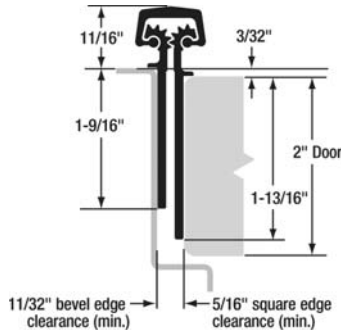
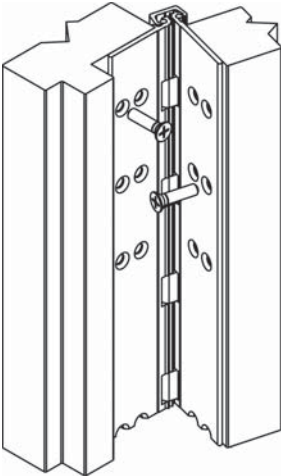

- ◆ Narrow frame leaf
- ◆ For new construction
- ◆ For renovation with new doors and/or frames
- ◆ No mortising of doors or frames required
- ◆ Will cover butt hinge cutouts in old frames
- ◆ Material - Extruded 6063-T6 Aluminum Alloy w/ Polyester thrust bearings
- ◆ Can manufacturer hole sizes & locations per customers specs
- ◆ No door reinforcement required
- ◆ Over 200 lbs. reinforce frame with 16 Ga. Channel
- ◆ For 2" doors up to 450 lbs.
- ◆ 3/32" Door inset
- ◆ For use on flush aluminum, glass rail, hollow metal or wood doors
- ◆ Template and hole pattern is same from hinge to hinge
- ◆ 83" can be field cut to 79" without cutting thru a bearing or mounting holes
- ◆ Hinge is non-handed unless cut in the field
- ◆ UL listed for 90 minute rated doors
- ◆ Can be UL listed for up to 3 hours

PBB Model Number	Length		Screw Count		LL Screw Count	
	Inches	Centimeters	Door	Jamb	Door	Jamb
CG31PN83	83"	210.8	25	25	25	25
CG31PN85	85"	215.9	25	25	25	25
CG31PN95	95"	241.3	29	29	29	29
CG31PN120	120"	304.8	33	33	33	33

628 - CLEAR ANODIZED - US28

710 - DARK ANODIZED - US10B

Full Mortise Fasteners-	
<p><b>Screw Pack A</b> #12-24 x 1/2" Phillips Flat Head Undercut Thread Forming Screws</p>	



# CG31I HEAVY DUTY SERIES

## FULL MORTISE 1 1/8" INSET

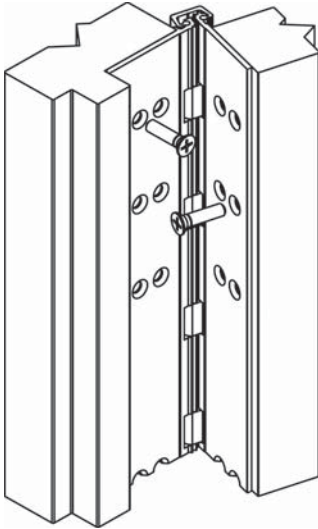

Closed Position

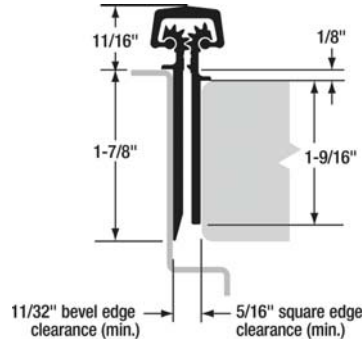

90° Open Position

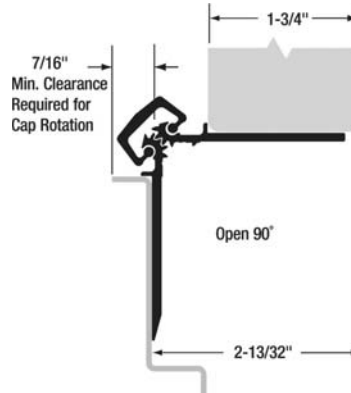

180° Open Position

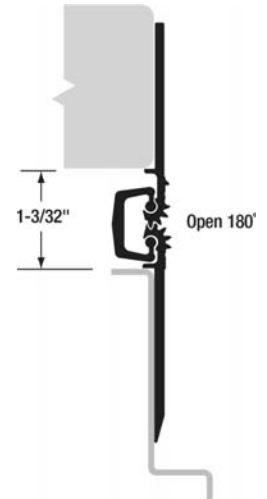

- ◆ For new construction
- ◆ 1/8" Inset
- ◆ For renovation with new doors and/or frames
- ◆ No mortising of doors or frames required
- ◆ Will cover butt hinge cut-outs in old frames
- ◆ Material - Extruded 6063-T6 Aluminum Alloy w / Polyester thrust bearings
- ◆ Can manufacturer hole sizes & locations per customers specs
- ◆ No door reinforcement required
- ◆ Over 200 lbs. reinforce frame with 16 Ga. Channel
- ◆ For 1 3/4" doors up to 450 lbs
- ◆ LL for doors up to 1000 lbs
- ◆ Template and hole pattern is same from hinge to hinge
- ◆ 83" can be field cut to 79" without cutting thru a bearing or mounting
- ◆ Hinge is non-handed unless cut in the field
- ◆ UL listed for 90 minute rated doors
- ◆ Can be UL listed for up to 3 hours

PBB Model Number	Length		Screw Count		LL Screw Count	
	Inches	Centimeters	Door	Jamb	Door	Jamb
CG31I83	83"	210.8	19	19	26	26
CG31I85	85"	215.9	19	19	26	26
CG31I95	95"	241.3	21	21	30	30
CG31I120	120"	304.8	23	23	34	34

628 - CLEAR ANODIZED - US28

710 - DARK ANODIZED - US10B

Full Mortise Fasteners-	
<b>Screw Pack A</b> #12-24 x 1/2" Phillips Flat Head Undercut Thread Forming Screws	



# CG31 HEAVY DUTY SERIES

## FULL MORTISE FLUSH MOUNT

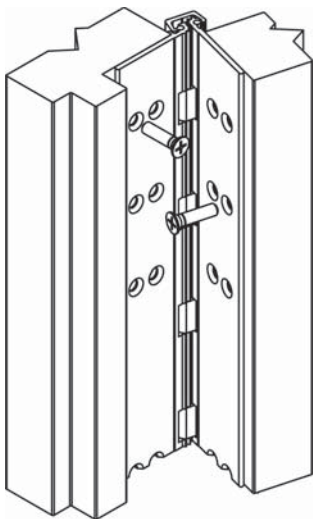

Closed Position

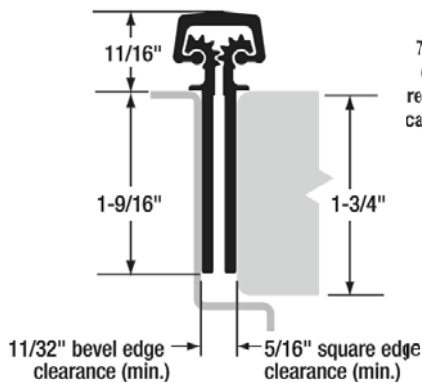

90° Open Position

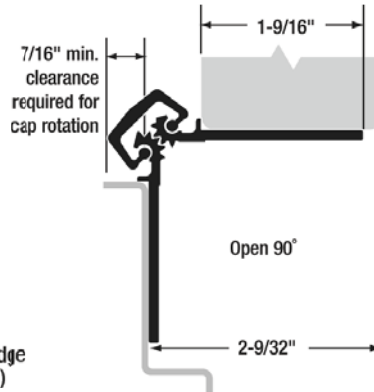

180° Open Position

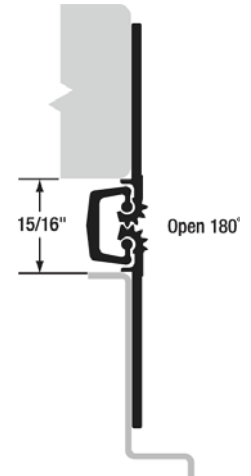

- ◆ For new construction
- ◆ Flush Mount
- ◆ For renovation with new doors and/or frames
- ◆ No mortising of doors or frames required
- ◆ Will cover butt hinge cutouts in old frames
- ◆ Material - Extruded 6063-T6 Aluminum Alloy w/ Polyester thrust bearings
- ◆ Can manufacturer hole sizes & locations per customers specs
- ◆ No door reinforcement required
- ◆ Over 200 lbs. reinforce frame with 16 Ga. Channel
- ◆ For 1 3/4" doors up to 450 lbs.
- ◆ LL for doors up to 1000 lbs
- ◆ Template and hole pattern is same from hinge to hinge
- ◆ 83" can be field cut to 79" without cutting thru a bearing or mounting holes
- ◆ Hinge is non-handed unless cut in the field
- ◆ UL listed for 90 minute rated doors
- ◆ Can be UL listed for up to 3 hours

PBB Model Number	Length		Screw Count		LL Screw Count	
	Inches	Centimeters	Door	Jamb	Door	Jamb
CG3183	83"	210.8	19	19	26	26
CG3185	85"	215.9	19	19	26	26
CG3195	95"	241.3	21	21	30	30
CG31120	120"	304.8	23	23	34	34

628 - CLEAR ANODIZED - US28

710 - DARK ANODIZED - US10B

Full Mortise Fasteners-	
<p><b>Screw Pack A</b> #12-24 x 1/2" Phillips Flat Head Undercut Thread Forming Screws</p>	



# CG31P HEAVY DUTY SERIES

## FULL MORTISE FLUSH MOUNT

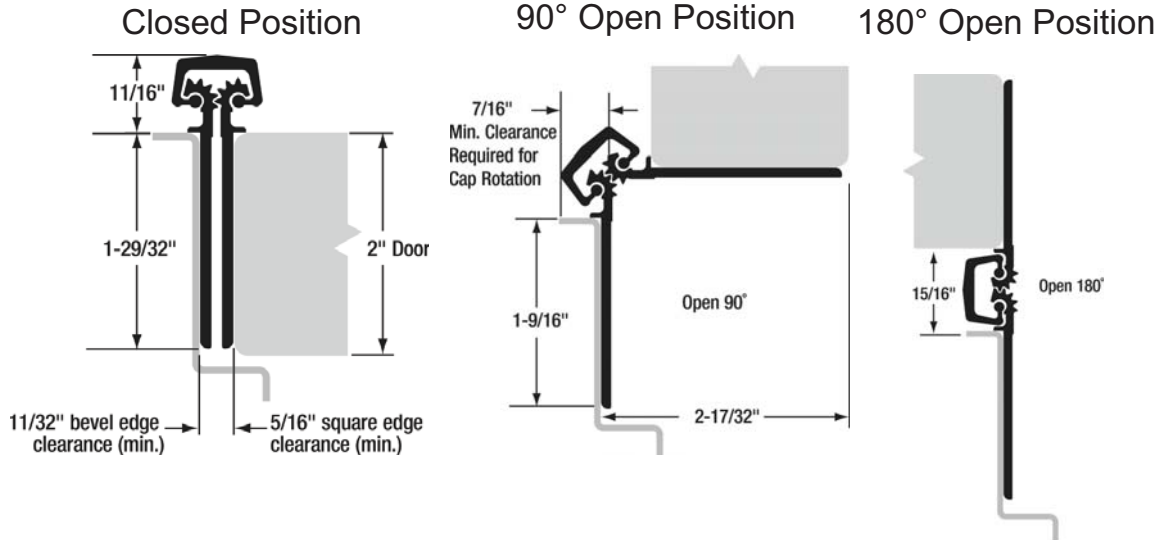
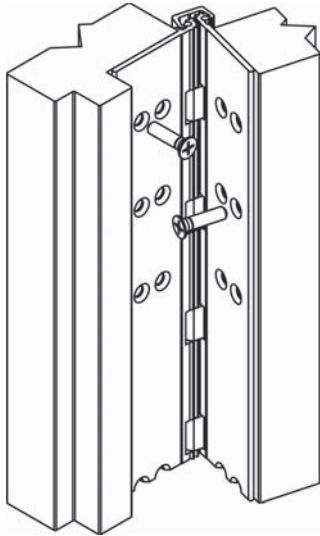

- ◆ For new construction
- ◆ Flush mount, no inset
- ◆ For renovation with new doors and/or frames
- ◆ No mortising of doors or frames required
- ◆ Will cover butt hinge cut-outs in old frames
- ◆ Material - Extruded 6063-T6 Aluminum Alloy w / Polyester thrust bearings
- ◆ Can manufacturer hole sizes & locations per customers specs
- ◆ No door reinforcement required
- ◆ Over 200 lbs. reinforce frame with 16 Ga. Channel
- ◆ For 2" doors up to 450 lbs
- ◆ LL for doors up to 1000 lbs
- ◆ Template and hole pattern is same from hinge to hinge
- ◆ 83" can be field cut to 79" without cutting thru a bearing or mounting
- ◆ Hinge is non-handed unless cut in the field
- ◆ UL listed for 90 minute rated doors
- ◆ Can be UL listed for up to 3 hours

PBB Model Number	Length		Screw Count		LL Screw Count	
	Inches	Centimeters	Door	Jamb	Door	Jamb
CG31P83	83"	210.8	25	25	25	25
CG31P85	85"	215.9	25	25	25	25
CG31P95	95"	241.3	29	29	29	29
CG31P120	120"	304.8	33	33	33	33

628 - CLEAR ANODIZED - US28

710 - DARK ANODIZED - US10B

Full Mortise Fasteners-	
<p><b>Screw Pack A</b></p> <p>#12-24 x 1/2" Phillips Flat Head Undercut Thread Forming Screws</p>	



# CG31CL HEAVY DUTY SERIES

## SWING CLEAR FULL MORTISE 1/16" INSET

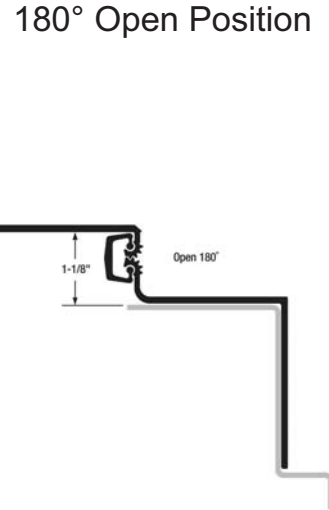
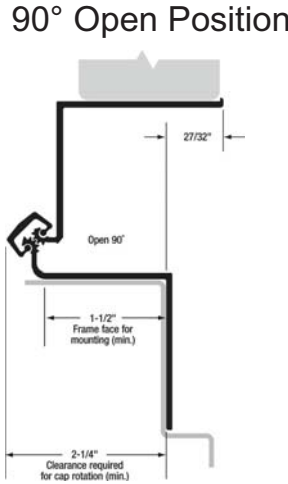
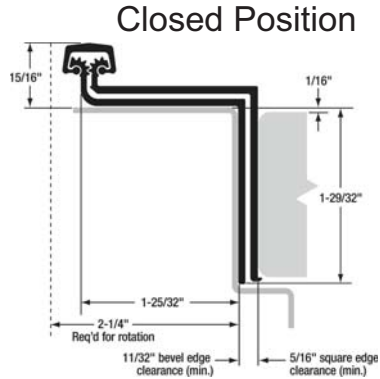
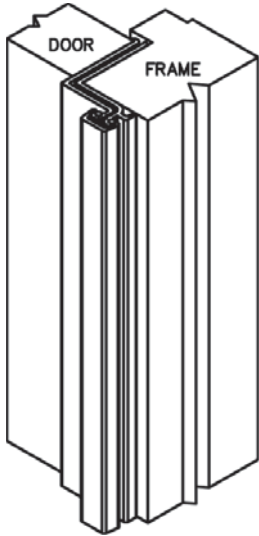

- ◆ For new construction
- ◆ 1/16" Door inset
- ◆ For renovation with new doors and/or frames
- ◆ No mortising of doors or frames required
- ◆ Will cover butt hinge cutouts in old frames
- ◆ Material - Extruded 6063-T6 Aluminum Alloy w/ Polyester thrust bearings
- ◆ Can manufacturer hole sizes & locations per customers specs
- ◆ No door reinforcement required
- ◆ Over 200 lbs. reinforce frame with 16 Ga. Channel
- ◆ For 1 3/4" doors up to 450 lbs.
- ◆ LL for doors up to 1000 lbs
- ◆ Template and hole pattern is same from hinge to hinge
- ◆ 83" can be field cut to 79" without cutting thru a bearing or mounting holes
- ◆ Hinge is non-handed unless cut in the field
- ◆ UL listed for 90 minute rated doors

PBB Model Number	Length		Screw Count		LL Screw Count	
	Inches	Centimeters	Door	Jamb	Door	Jamb
CG31CL83	83"	210.8	19	19	26	26
CG31CL85	85"	215.9	19	19	26	26
CG31CL95	95"	241.3	21	21	30	30
CG31CL120	120"	304.8	23	23	34	34

628 - CLEAR ANODIZED - US28

710 - DARK ANODIZED - US10B

Full Mortise Fasteners-	
<p><b>Screw Pack A</b> #12-24 x 1/2" Phillips Flat Head Undercut Thread Forming Screws</p>	





## CG33N HEAVY DUTY SERIES

### FULL SURFACE NARROW FRAME 1/16" INSET

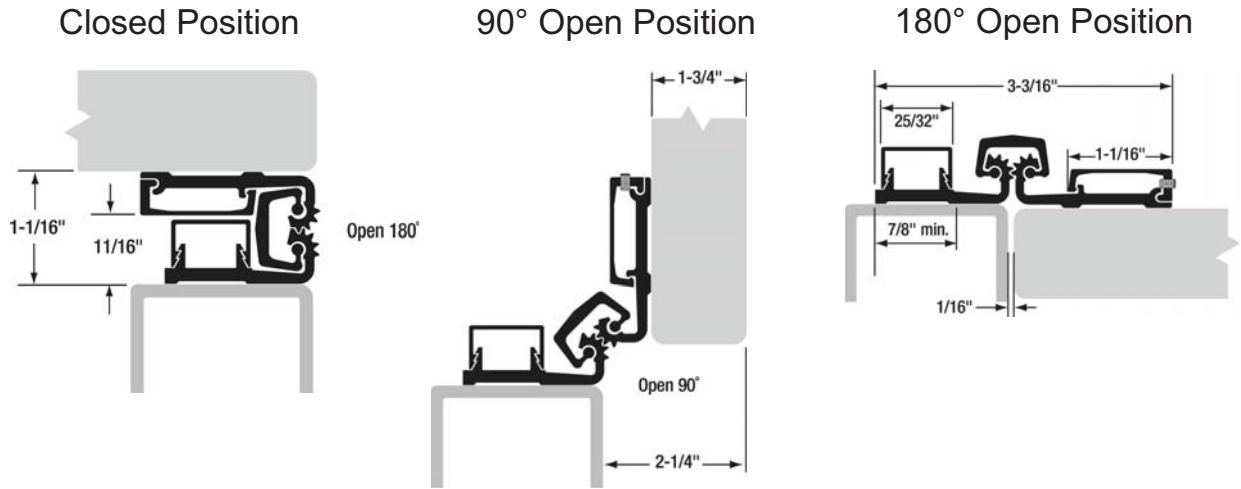
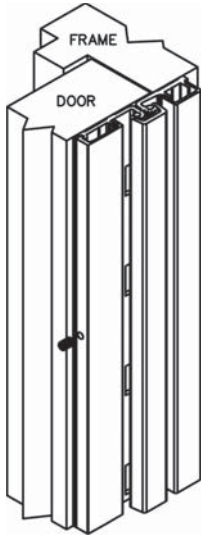

- ◆ For new construction
- ◆ For use on flush aluminum, glass rail, hollow metal or wood doors
- ◆ For permanent replacement of existing doors and frames
- ◆ No mortising of doors or frames required
- ◆ Will cover butt hinge cutouts in old frames
- ◆ Full Surface
- ◆ Requires 7/8" minimum frame size
- ◆ 1/16" inset
- ◆ Material - Extruded 6063-T6 Aluminum Alloy w/ Polyester thrust bearings
- ◆ Can manufacturer hole sizes & locations per customers specs
- ◆ No door reinforcement required
- ◆ For doors up to 450 lbs.
- ◆ Template and hole pattern is same from hinge to hinge
- ◆ 83" can be field cut to 79" without cutting thru a bearing or mounting holes
- ◆ Hinge is non-handed unless cut in the field
- ◆ Can be UL listed for up to 3 hours

PBB Model Number	Length		Screw Count	
	Inches	Centimeters	Door	Jamb
CG33N83	83"	210.8	10	14
CG33N85	85"	215.9	10	14
CG33N95	95"	241.3	11	15
CG33N120	120"	304.8	14	18

628 - CLEAR ANODIZED - US28

710 - DARK ANODIZED - US10B

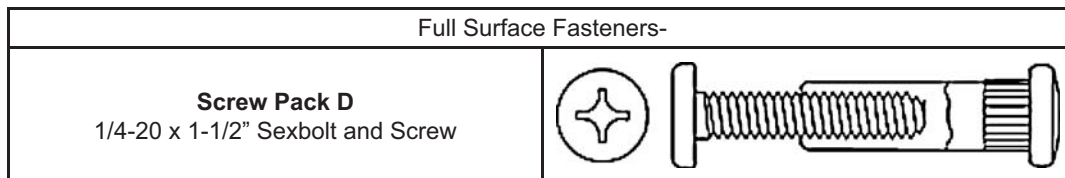



## CG33C HEAVY DUTY SERIES

### FULL SURFACE SWING CLEAR 1/32" INSET

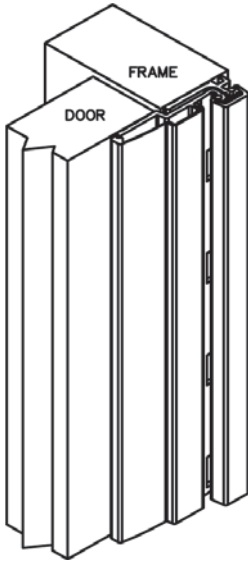

Closed Position

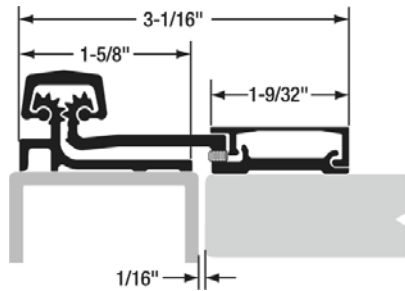

90° Open Position

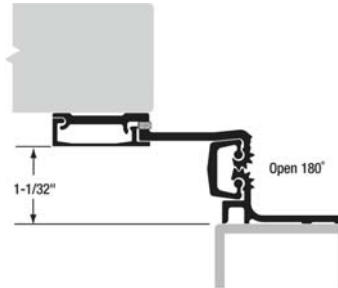

180° Open Position

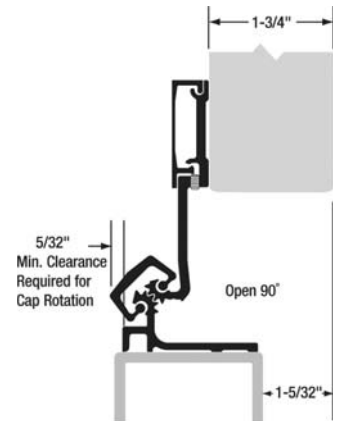

- ◆ For new construction
- ◆ For permanent replacement of existing frame and new doors
- ◆ No mortising of doors or frames required
- ◆ Will cover butt hinge cut-outs in old frames
- ◆ Swing door completely out of door opening
- ◆ For use on flush aluminum, glass rail, hollow metal or wood doors
- ◆ Full Surface
- ◆ 1/32" inset
- ◆ Material - Extruded 6063-T6 Aluminum Alloy w / Polyester thrust bearings
- ◆ Can manufacturer hole sizes & locations per customers specs
- ◆ No door reinforcement required
- ◆ Over 200 lbs reinforce frame with 16 Ga. Channel
- ◆ For doors up to 450 lbs
- ◆ Template and hole pattern is same from hinge to hinge
- ◆ 83" can be field cut to 79" without cutting thru a bearing or mounting
- ◆ Hinge is non-handed unless cut in the field
- ◆ UL listed for up to 3 hours

PBB Model Number	Length		Screw Count	
	Inches	Centimeters	Door	Jamb
CG33C83	83"	210.8	10	14
CG33C85	85"	215.9	10	14
CG33C95	95"	241.3	11	15
CG33C120	120"	304.8	14	18

628 - CLEAR ANODIZED - US28

710 - DARK ANODIZED - US10B

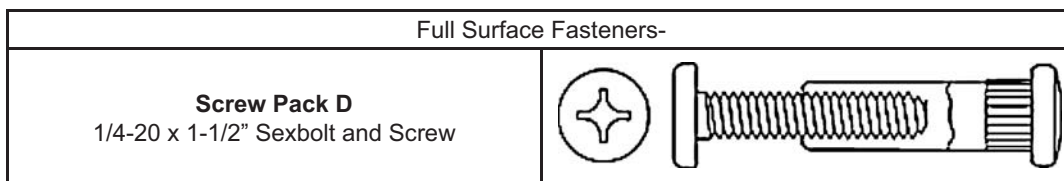



# CG34N HEAVY DUTY SERIES

## HALF SURFACE NARROW FRAME 3/32" INSET

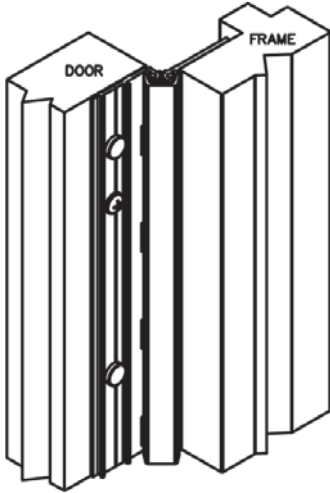

Closed Position

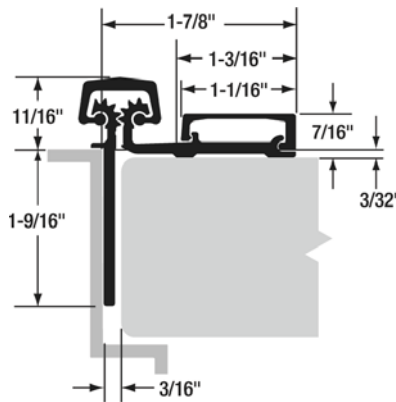

90° Open Position

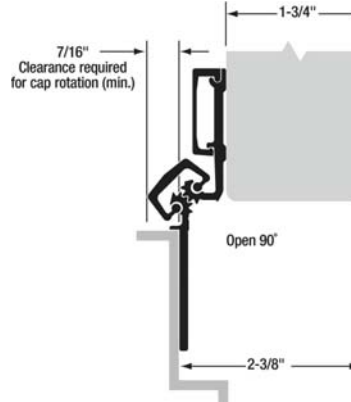

180° Open Position

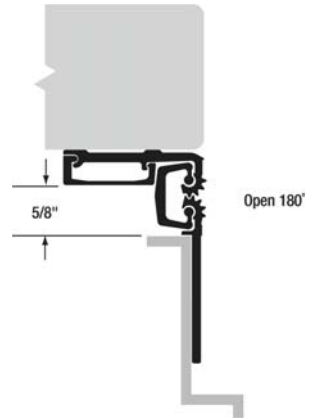

- ◆ For new construction
- ◆ For permanent replacement of existing frame and new doors
- ◆ No mortising of doors or frames required
- ◆ For use on flush aluminum, glass rail, hollow metal or wood doors
- ◆ Will cover butt hinge cut-outs in old frames
- ◆ Half Surface
- ◆ 3/32" inset
- ◆ 1-9/16" frame leaf
- ◆ Material - Extruded 6063-T6 Aluminum Alloy w / Polyester thrust bearings
- ◆ Can manufacturer hole sizes & locations per customers specs
- ◆ No door reinforcement required
- ◆ Over 200 lbs reinforce frame with 16 Ga. Channel
- ◆ For doors up to 450 lbs
- ◆ Template and hole pattern is same from hinge to hinge
- ◆ 83" can be field cut to 79" without cutting thru a bearing or mounting
- ◆ Hinge is non-handed unless cut in the field
- ◆ Can be UL listed for up to 3 hours

PBB Model Number	Length		Screw Count	
	Inches	Centimeters	Door	Jamb
CG34N83	83"	210.8	10	19
CG34N85	85"	215.9	10	19
CG34N95	95"	241.3	11	21
CG34N120	120"	304.8	14	23

628 - CLEAR ANODIZED - US28

710 - DARK ANODIZED - US10B

Half Surface Fasteners-			
<b>Screw Pack A</b> #12-24 x 1/2" Phillips Flat Head Undercut Thread Forming Screws		<b>Screw Pack D</b> 1/4-20 x 1-1/2" Sexbolt and Screw	



## CG34 HEAVY DUTY SERIES

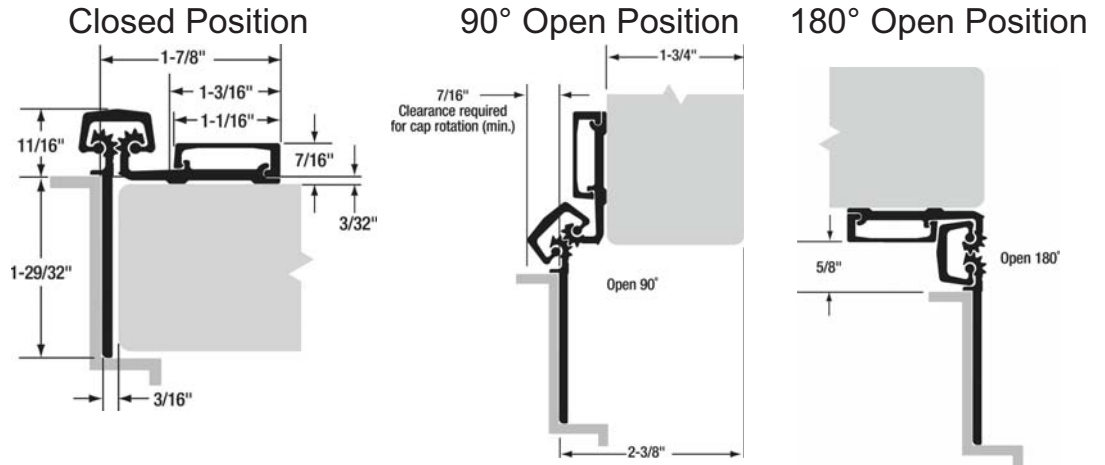
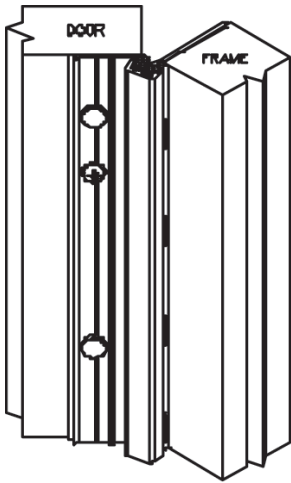

- ◆ For new construction
- ◆ For permanent replacement of existing doors and frames
- ◆ No mortising of doors or frames required
- ◆ For use on flush aluminum, glass rail, hollow metal or wood doors
- ◆ Will cover butt hinge cutouts in old frames
- ◆ Half Surface
- ◆ 1-29/32" frame leaf
- ◆ 3/32" inset
- ◆ Material - Extruded 6063-T6 Aluminum Alloy w/ Polyacetal thrust bearings
- ◆ Can manufacturer hole sizes & locations per customers specs
- ◆ No door reinforcement required
- ◆ Over 200 lbs reinforce frame with 16 Ga. Channel
- ◆ For doors up to 450 lbs.
- ◆ LL for doors up to 1000 lbs
- ◆ Template and hole pattern is same from hinge to hinge
- ◆ 83" can be field cut to 79" without cutting thru a bearing or mounting holes
- ◆ Hinge is non-handed unless cut in the field
- ◆ UL listed for up to 3 hours with use of Pryo Studs (Additional Cost)

PBB Model Number	Length		Screw Count	
	Inches	Centimeters	Door	Jamb
CG3483	83"	210.8	10	19
CG3485	85"	215.9	10	19
CG3495	95"	241.3	11	21
CG34120	120"	304.8	14	23

628 - CLEAR ANODIZED - US28

710 - DARK ANODIZED - US10B

Half Surface Fasteners-			
<b>Screw Pack A</b> #12-24 x 1/2" Phillips Flat Head Undercut Thread Forming Screws		<b>Screw Pack D</b> 1/4-20 x 1-1/2" Sexbolt and Screw	



# ALUMINUM CONTINUOUS GEAR HINGES TEMPLATES

## CG31-CG31L-CG31L

### 79# HD\*

### 83# SD

### 83# HD

### 83# LL

38 fasteners / 31 bearings

38 fasteners / 16 bearings

38 fasteners / 32 bearings

52 fasteners / 32 bearings

HOLES

HOLES

HOLES

HOLES

BEARING SLOTS

BEARING SLOTS

BEARING SLOTS

BEARING SLOTS

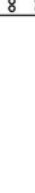
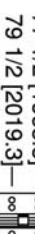
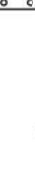
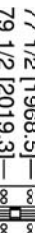
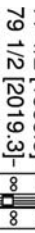
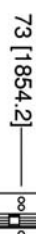
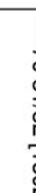
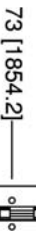
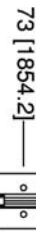
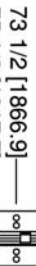
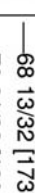
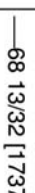
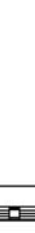
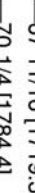
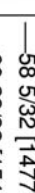
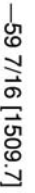
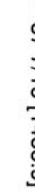
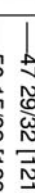
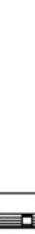
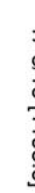
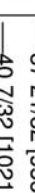
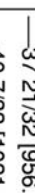
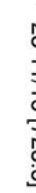
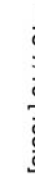
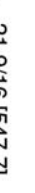
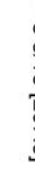
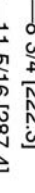
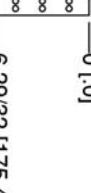
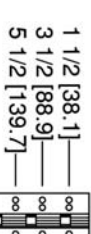
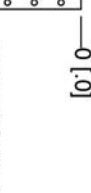
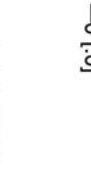
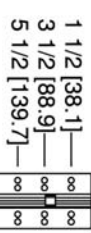
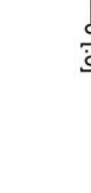
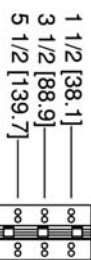

\*Excluding Model CG311

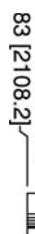
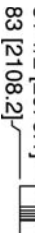
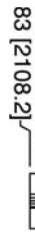



# ALUMINUM CONTINUOUS GEAR HINGES TEMPLATES

**CG31-CG31L-CG31L**

**85<sup>μ</sup> SD**

**38 fasteners / 16 bearings**

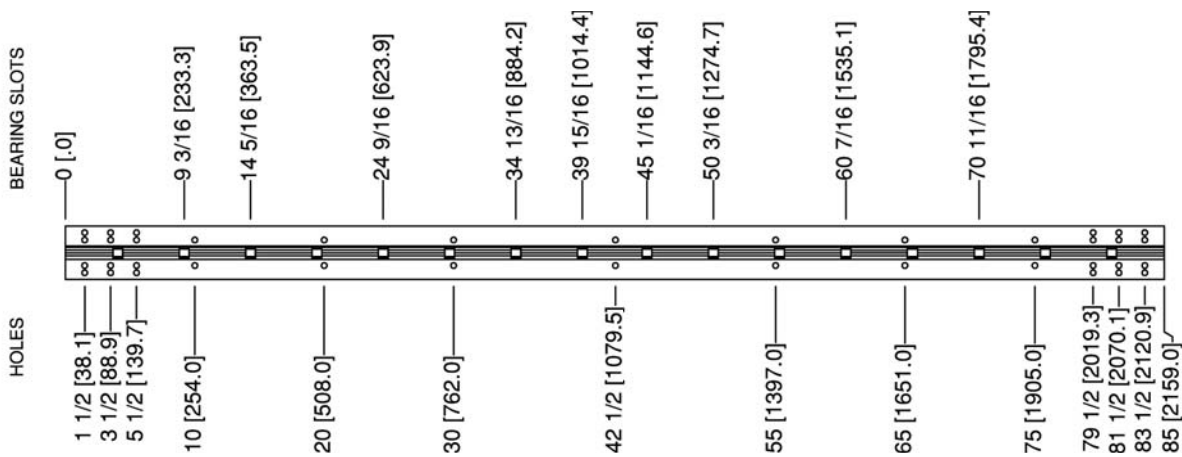

**85<sup>μ</sup> HD**

**38 fasteners / 32 bearings**

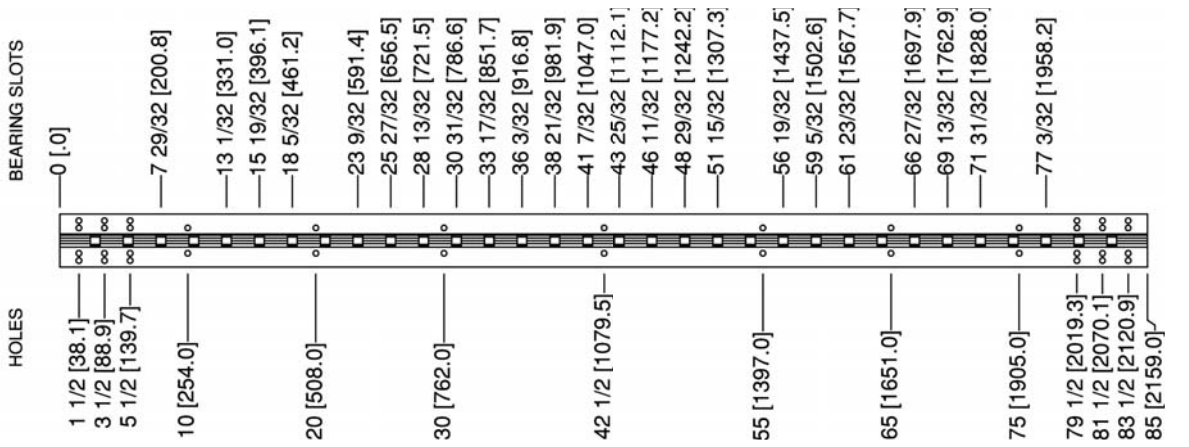

**85<sup>μ</sup> LL**

**52 fasteners / 32 bearings**

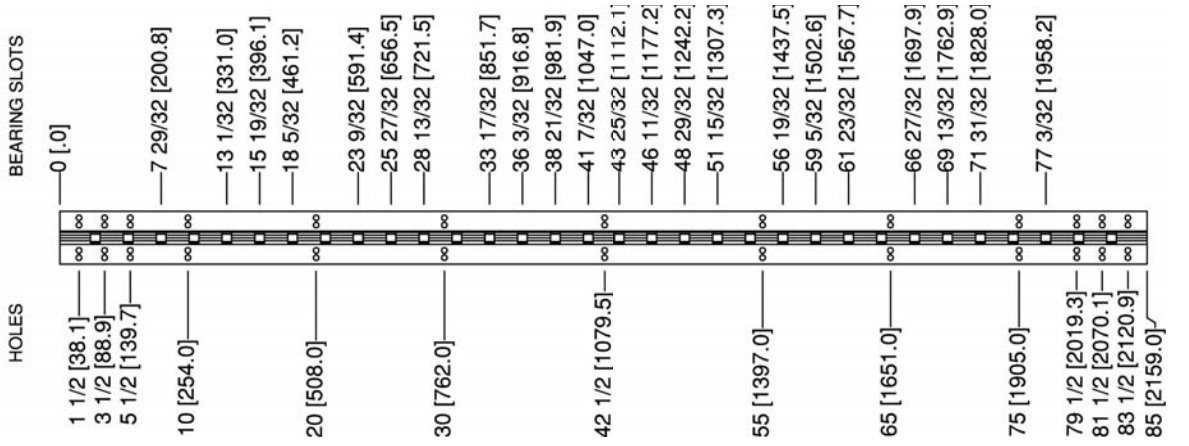

**95<sup>μ</sup> SD**

**42 fasteners / 18 bearings**

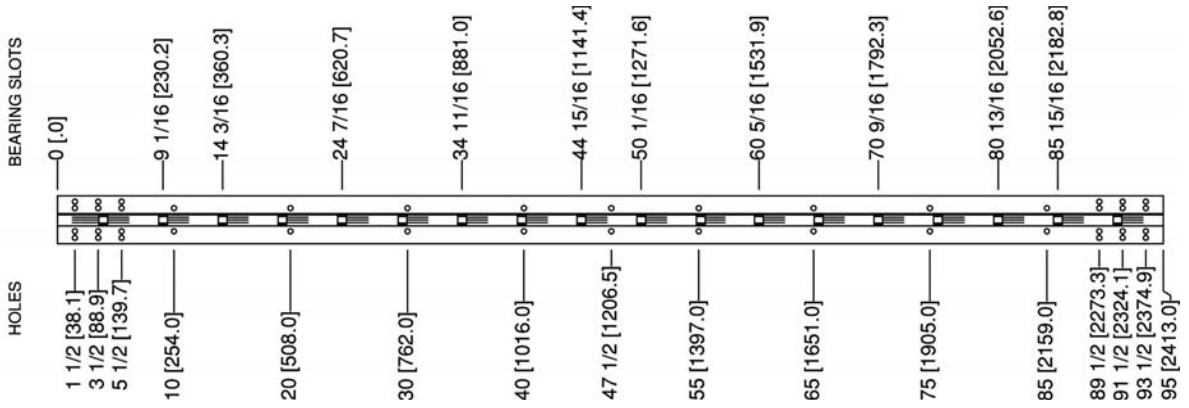



# ALUMINUM CONTINUOUS GEAR HINGES TEMPLATES

## CG31-CG31L-CG31L

### 95# HD

#### 46 fasteners / 47 bearings

HOLES BEARING SLOTS

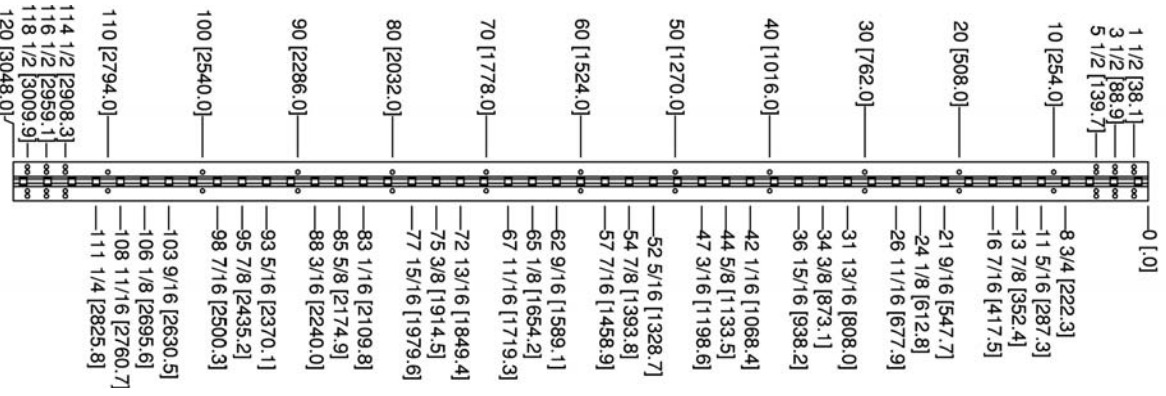

### 95# LL

#### 46 fasteners / 23 bearings

HOLES BEARING SLOTS

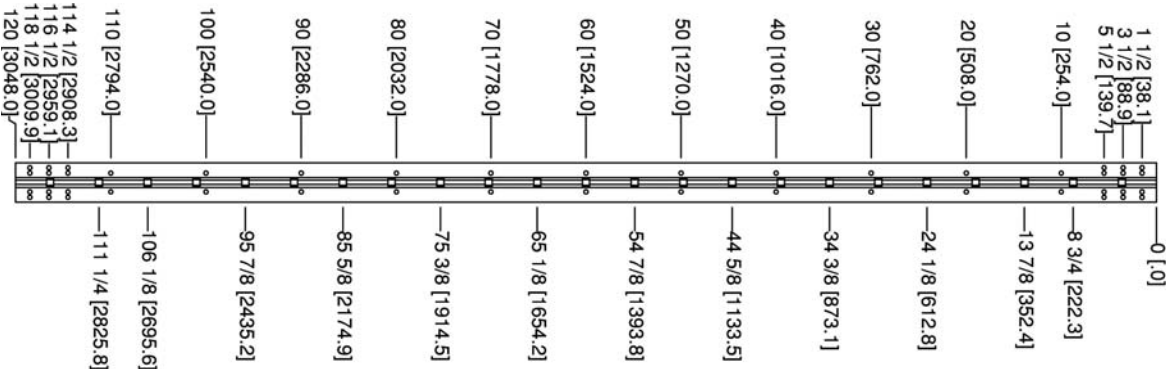

### 120# SD

#### 42 fasteners / 36 bearings

HOLES BEARING SLOTS

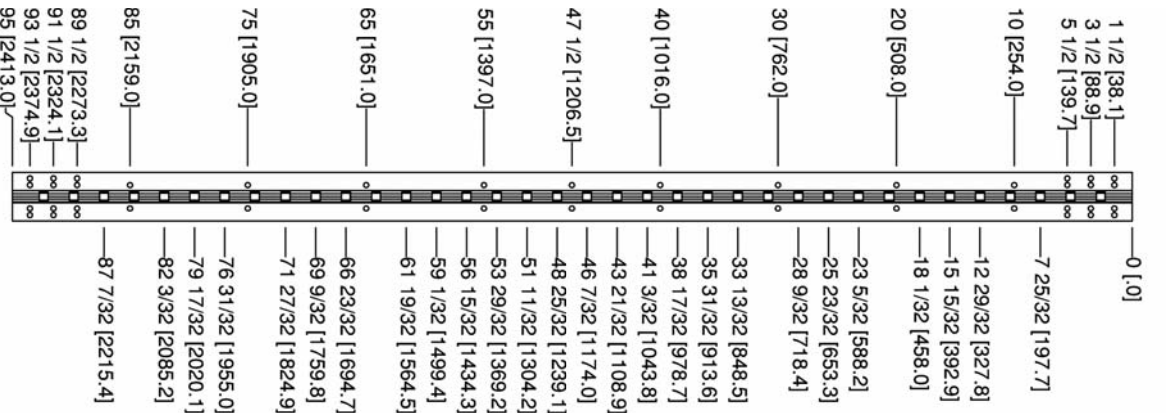

### 120# HD

#### 60 fasteners / 36 bearings

HOLES BEARING SLOTS

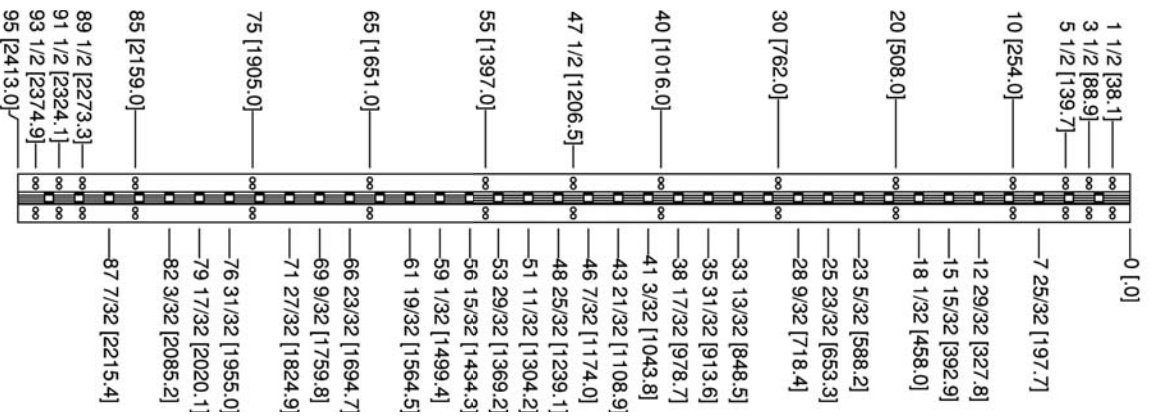



# ALUMINUM CONTINUOUS GEAR HINGES TEMPLATES

CG31PN-CG31P

83<sup>rd</sup> LL

50 fasteners / 32 bearings

HOLES

BEARING SLOTS

BEARING SLOTS

58 fasteners / 36 bearings

HOLES

66 fasteners / 47 bearings

HOLES

BEARING SLOTS

85<sup>th</sup> LL

50 fasteners / 32 bearings

HOLES

BEARING SLOTS

95<sup>th</sup> LL

58 fasteners / 36 bearings

HOLES

BEARING SLOTS

120<sup>th</sup> LL

58 fasteners / 36 bearings

HOLES

BEARING SLOTS

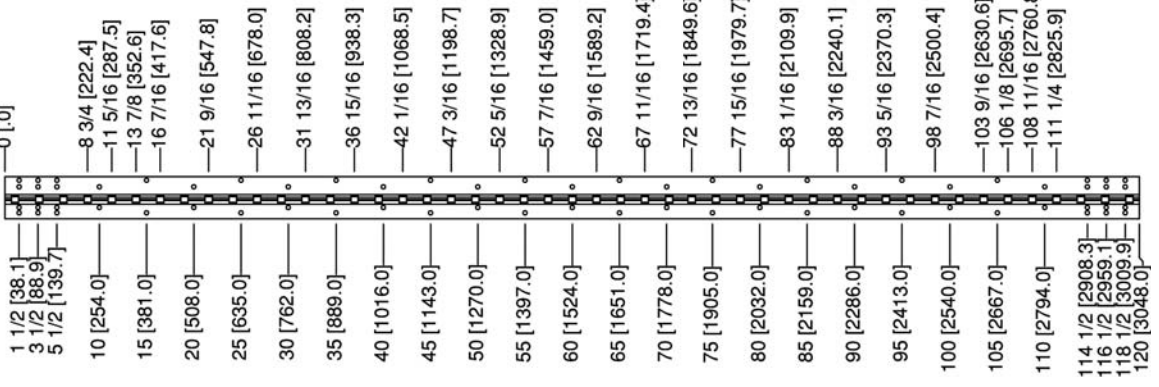
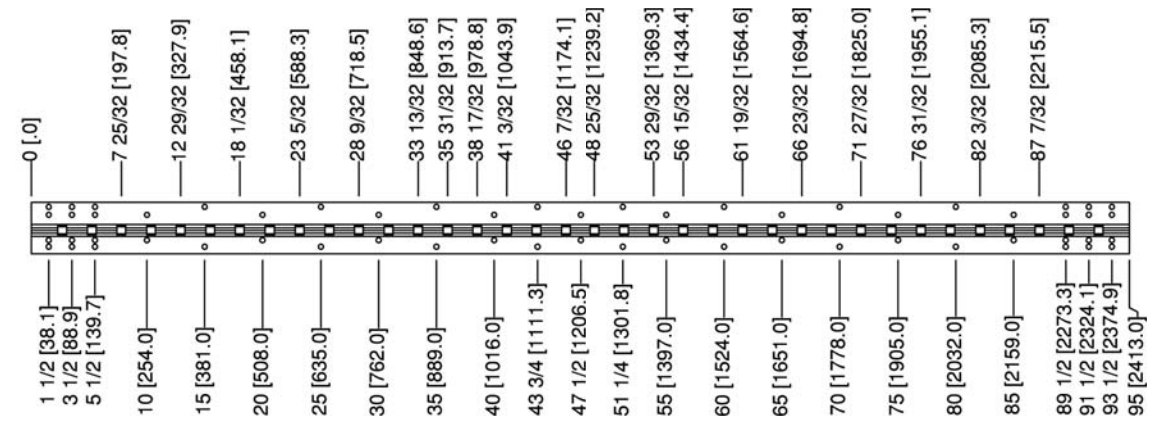
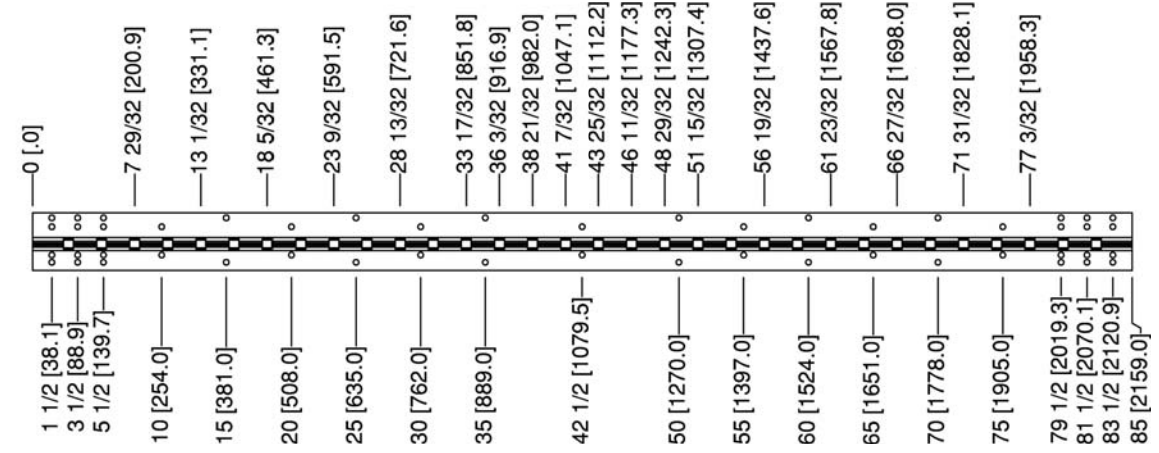
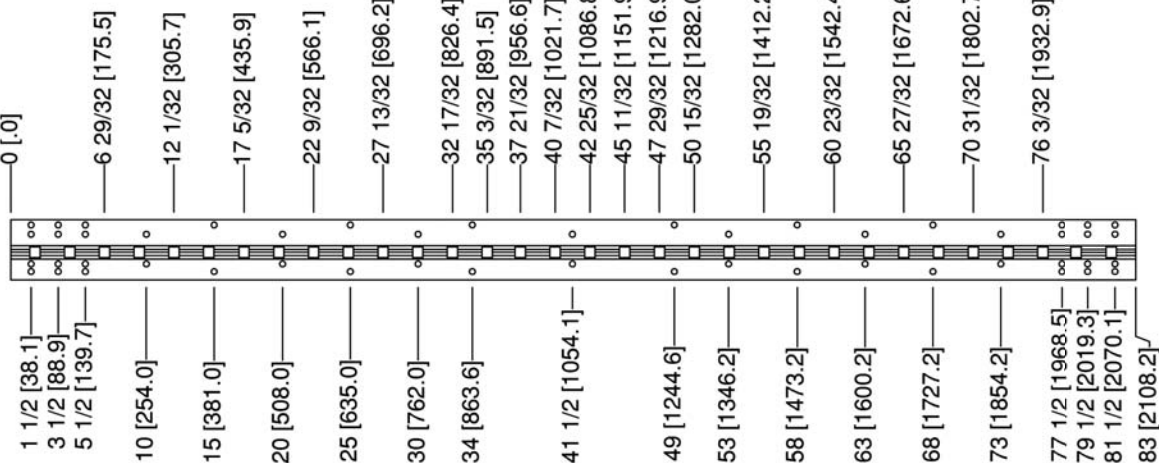





# ALUMINUM CONTINUOUS GEAR HINGES TEMPLATES

CG33N-CG33C

83" SD & HD

85" SD & HD

95" SD & HD

120" SD & HD

24 fasteners / SD:16 bearings / HD:32 bearings • 24 fasteners / SD:16 bearings / HD:32 bearings • 26 fasteners / SD:18 bearings / HD:36 bearings • 32 fasteners / SD:23 bearings / HD:47 bearings

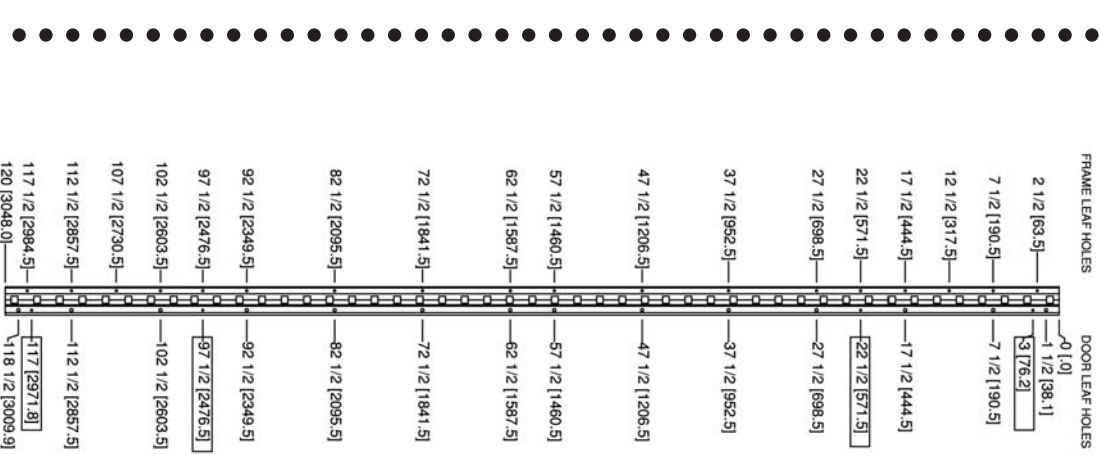
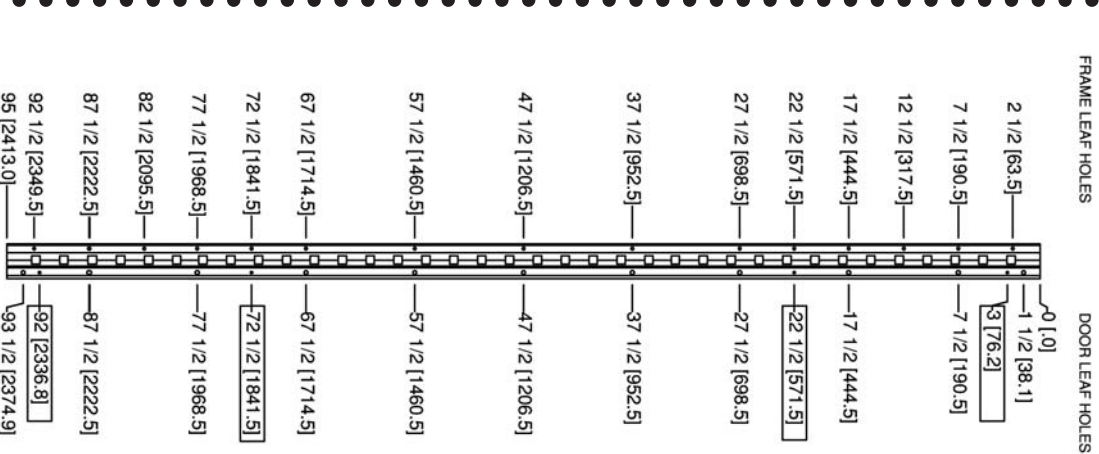
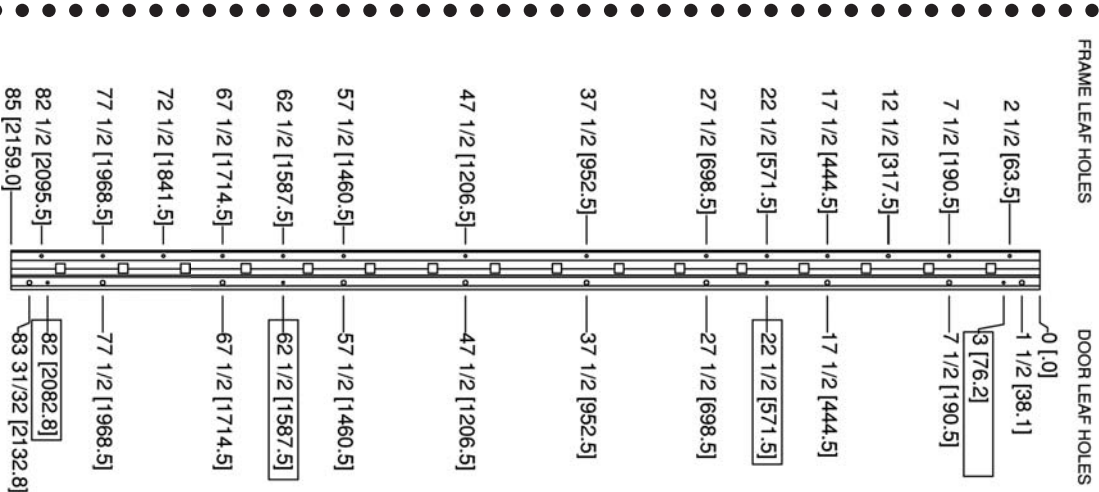
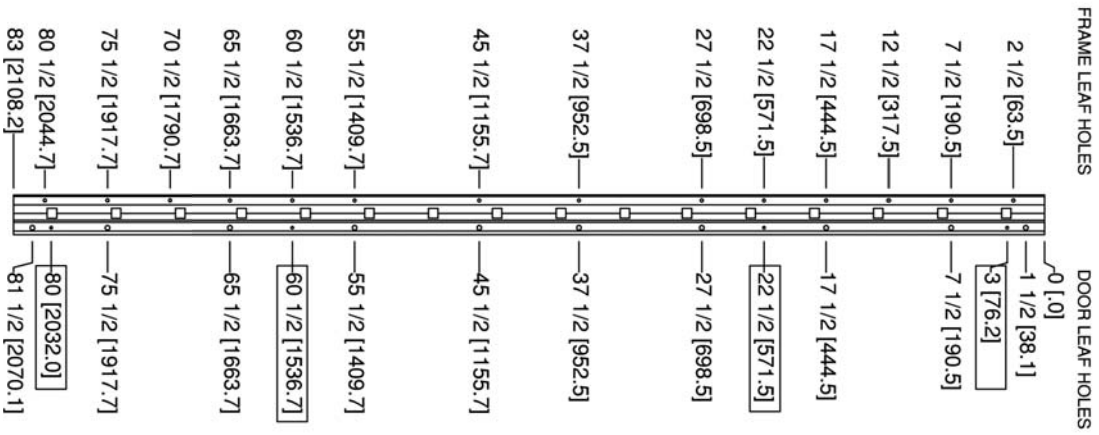



# ALUMINUM CONTINUOUS GEAR HINGES TEMPLATES

**CG31CL**

**83<sup>rd</sup> FD**

44 fasteners / 32 bearings

HOLES

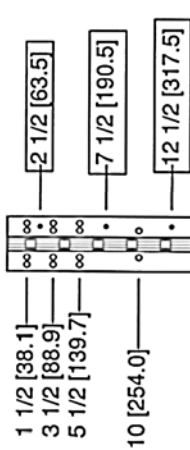

58 fasteners / 32 bearings

HOLES

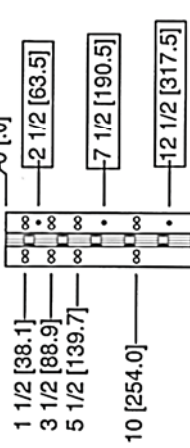

44 fasteners / 32 bearings

HOLES

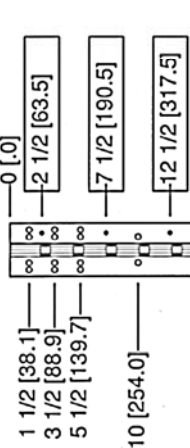

58 fasteners / 32 bearings

HOLES

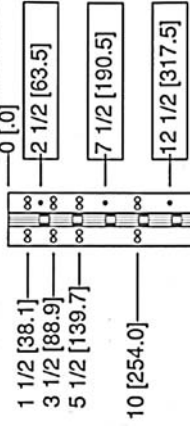



# ALUMINUM CONTINUOUS GEAR HINGES TEMPLATES

CG31CL

95<sup>th</sup> HD

48 fasteners / 36 bearings

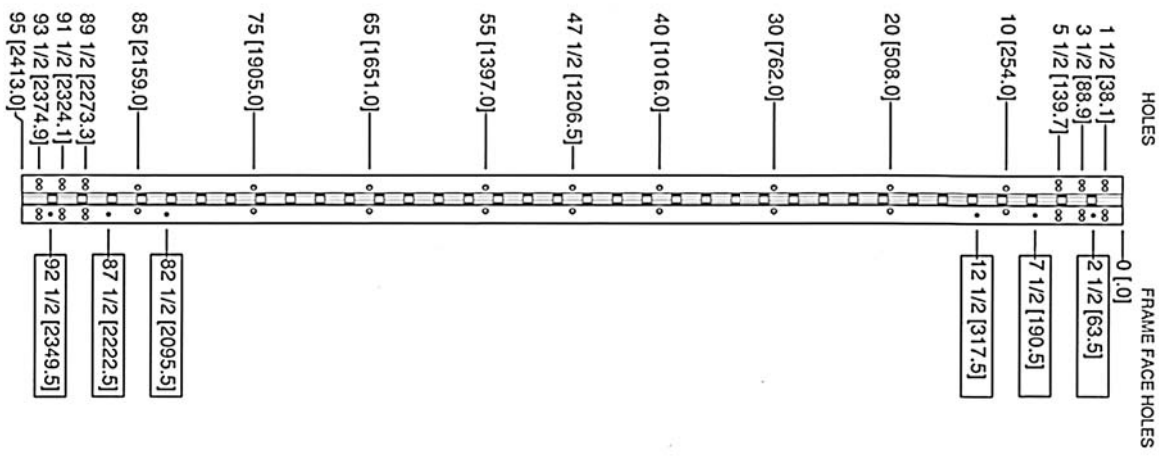

95<sup>th</sup> LL

66 fasteners / 36 bearings

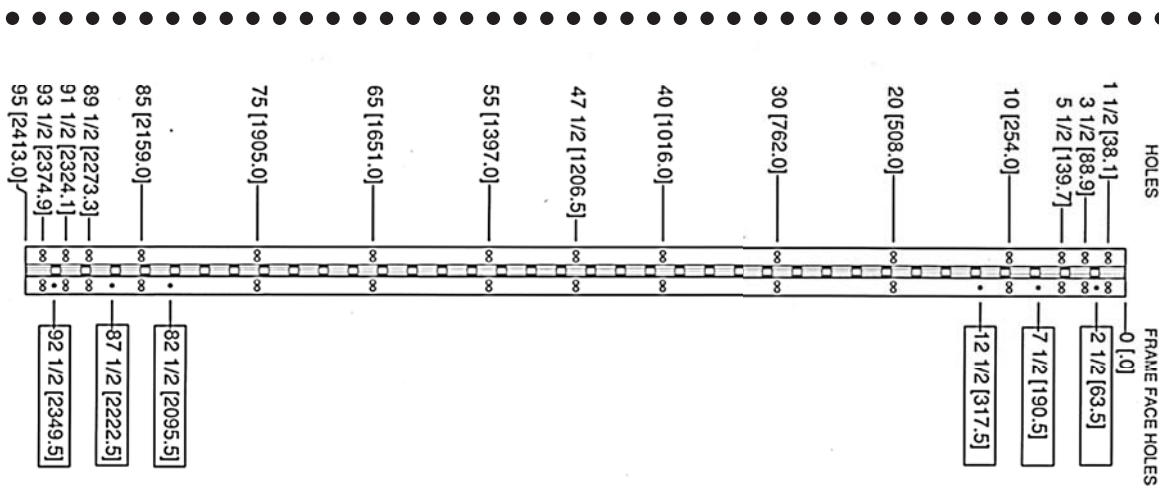

120<sup>th</sup> HD

52 fasteners / 47 bearings

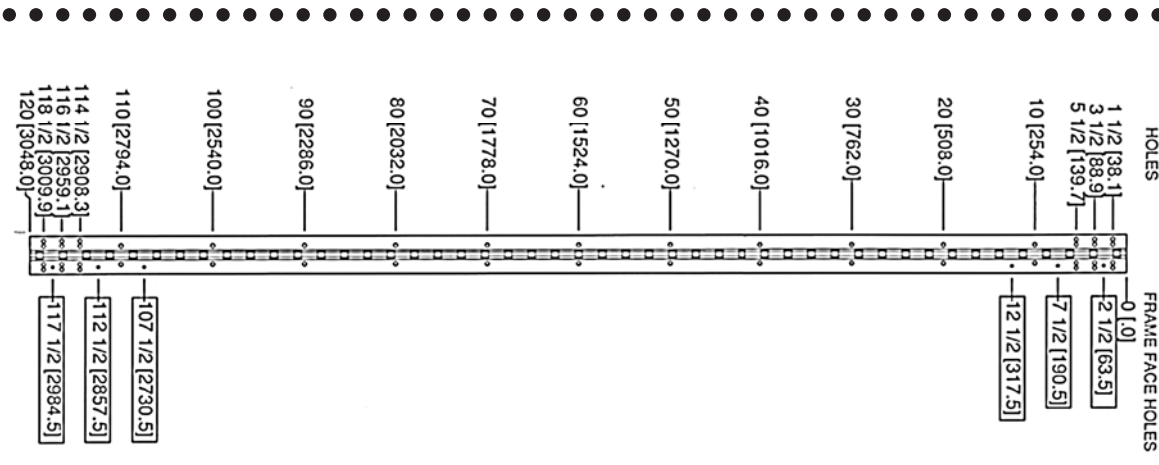

120<sup>th</sup> LL

74 fasteners / 47 bearings

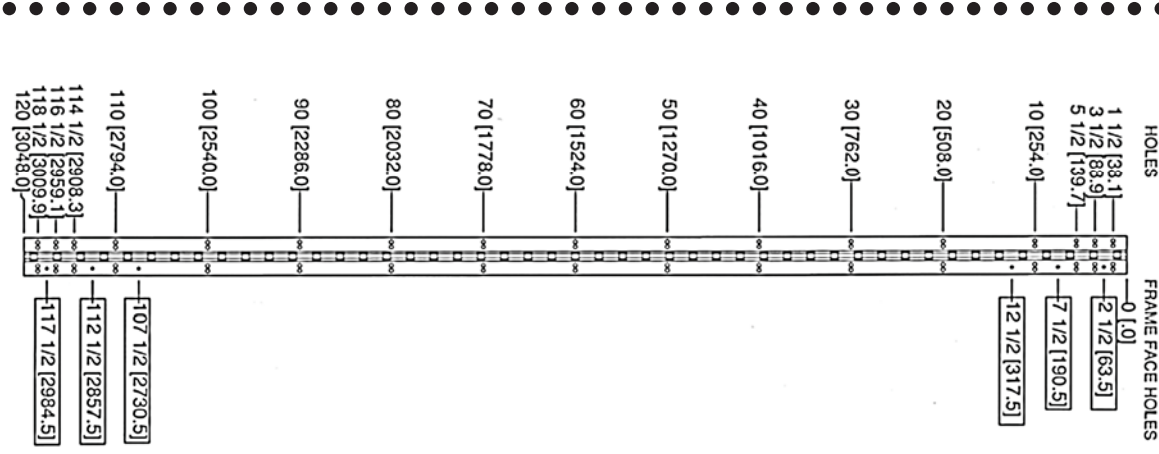



# ALUMINUM CONTINUOUS GEAR HINGES TEMPLATES

CG34N-CG34

## 83# HD

29 fasteners / 32 bearings

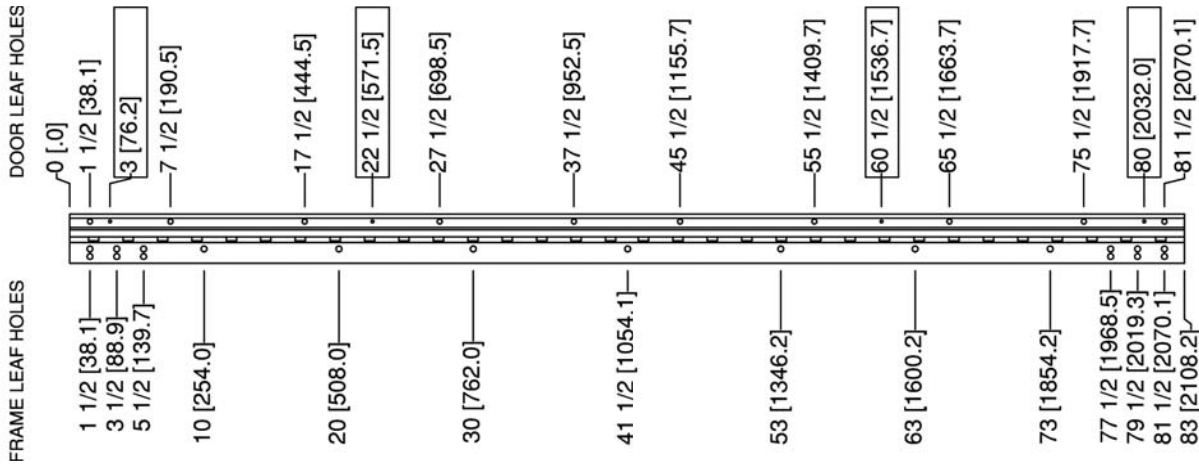

## 85# HD

29 fasteners / 32 bearings

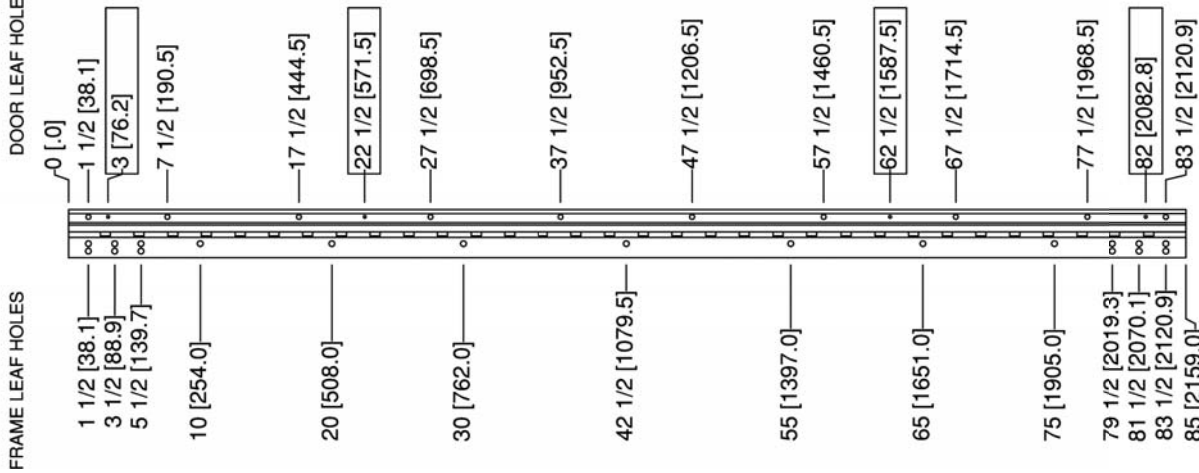

## 95# HD

33 fasteners / 36 bearings

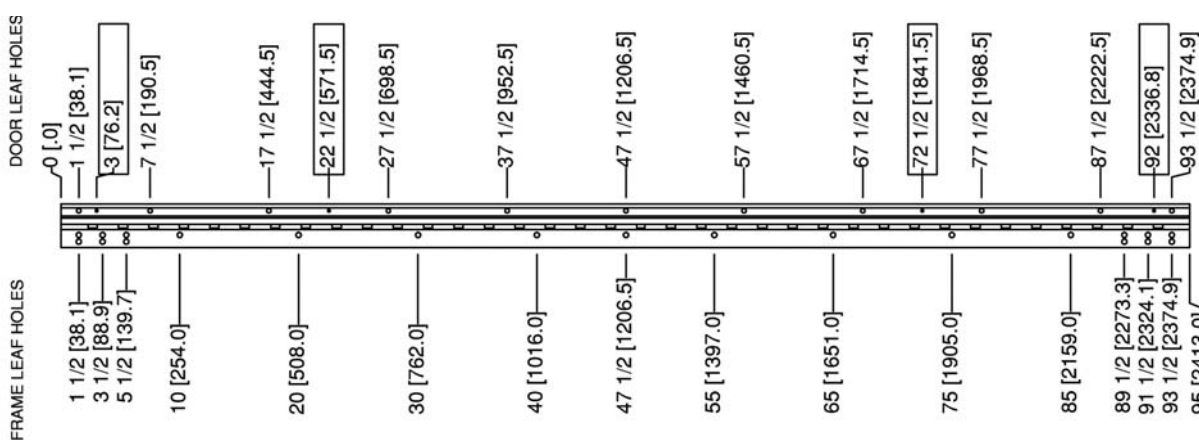

## 120# HD

37 fasteners / 47 bearings

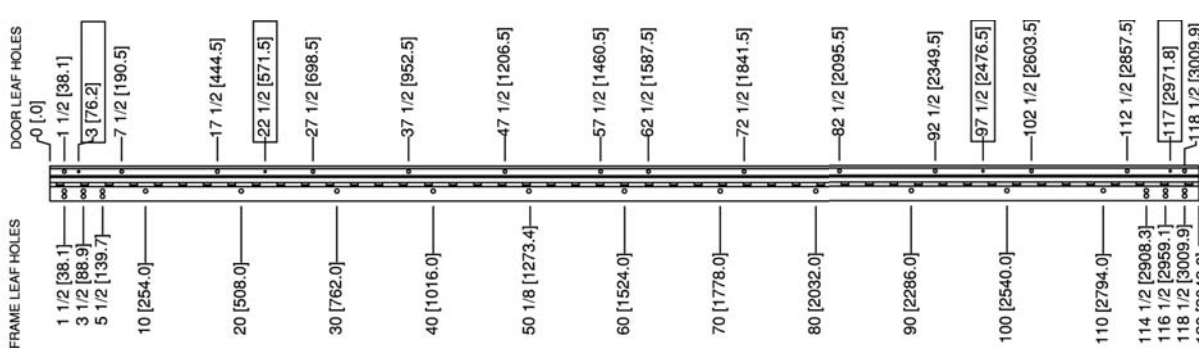



# INSTALLATION INSTRUCTIONS

CG31-CG31I-CG31L-CG31PN-CG31P

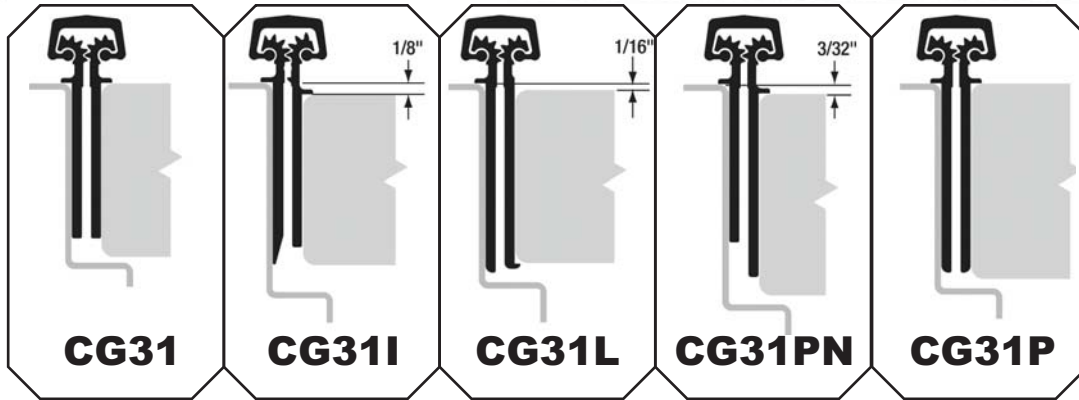

## Calculating Required Door Clearances

### For Square and Beveled-Edge Doors

**IMPORTANT:** All standard length PBB hinges are supplied slightly shorter than nominal door height to avoid threshold or flooring clearance problems.

**IMPORTANT:** CG31 and CG31P are non-handed and templated. They remain non-handed after cutting. CG31I, CG31L, and CG31PN become handed after cutting.

**IMPORTANT:** Refer to NFPA 80 manual for clearance requirements on fire-rated entrances.

### SINGLE DOOR: Square Edge

Hinge side clearance	5/16"
Latch side clearance	1/8"
Frame variance clearance	1/32"
<b>Total Width Clearance</b>	<b>15/32"</b>

**To determine door width:** - - - - -  
Subtract the Total Width Clearance from the width of the frame opening.

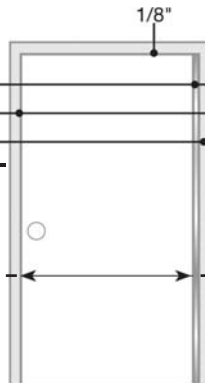

### SINGLE DOOR: Beveled Edge

Hinge side clearance	5/16"
Latch side clearance	1/8"
Frame variance clearance	1/32"
Beveled edge clearance	1/32"
<b>Total Width Clearance</b>	<b>1/2"</b>

**To determine door width:**  
Subtract the Total Width Clearance from the width of the frame opening.

### DOUBLE DOOR (PAIR): Square Edge

Hinge side clearance (2x)	5/16"
Latch side clearance	3/16"
Frame variance clearance	1/16"
<b>Total Width Clearance</b>	<b>7/8"</b>

**To determine door width:** - - - - -  
Subtract the Total Width Clearance from the width of the frame opening; divide the result by 2.

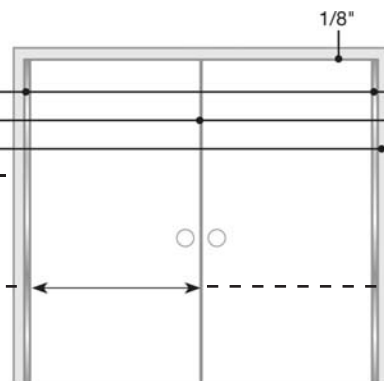

### DOUBLE DOOR (PAIR): Beveled Edge

Hinge side clearance (2x)	5/16"
Latch side clearance	3/16"
Frame variance clearance	1/16"
Beveled edge clearance	1/16"
<b>Total Width Clearance</b>	<b>15/16"</b>

**To determine door width:**  
Subtract the Total Width Clearance from the width of the frame opening; divide the result by 2.

**NOTE:** For double-door entrances with a mullion between the pair of doors, calculate each door width using the Single Door clearances. For double-door entrances with a mullion behind the pair of doors, calculate each door width using the Double Doors clearances.

### Important Warranty Information:

The following actions will void any warranty, expressed or implied:

- Failure to install the hinge according to the Installation Instructions supplied with every PBB hinge.
- Use of fasteners other than those supplied with the hinge.
- Unauthorized field modifications, including alteration or removal of the factory-applied lubricant, altering the original finish or painting the hinge.



# INSTALLATION INSTRUCTIONS

## CG31-CG31I-CG31L-CG31PII-CG31P

### Tools Needed

- Metal-cutting saw
- Tape measure
- #13 or 3/16" drill bit
- 5/32" drill bit (wood frames/doors)
- #3 Phillips drive
- Shims

### Parts Supplied

- #12-24 x 1/2" 410 SS thread-forming Phillips undercut flathead screws

### Optional Parts

- #12 x 1-1/2" 410 SS Phillips flathead undercut wood screws
- #12-24 x 3/4" 410 SS Phillips self-drilling thread forming (SDTF) undercut flathead screws

### How to Cut the Hinge to Fit

1. Keep hinge in the "door closed" position (Fig. 1).
2. Determine whether this will be a right- or left-hand installation. You will install the cut end at the bottom.

**NOTE:** CG31 and CG31P are non-handed and remain non-handed after cutting. Cut from one end only and use for right- or left-hand installation.

3. DO NOT cut through a set-screw bearing. Reinstall or relocate the set-screw bearing if necessary.
4. Using a metal-cutting saw, begin the cut through the gear cap first.

### A. Prepare Frame

1. Use shims to position the hinge 1/8" below the header to allow for door clearance.
2. Hold hinge in the "door open" position (Fig. 2) making sure the frame leaf alignment flange is tight against the frame face.
3. Mark (or center punch) hole locations. Drill holes at marked locations.
  - Metal door frame: Use a #13 (.185") or 3/16" (.188") drill bit.
  - Wood door frame: Use a 5/32" (.156") drill bit.

**IMPORTANT:** DO NOT attach the hinge to the frame at this time.

### B. Attach Door to Hinge

4. Align the door leaf alignment flange or the door leaf lip along the full length of the door edge (even if the door is slightly warped).

**IMPORTANT:** Top end of the hinge must be flush to a straight edge across the top of the door.

5. Mark (or center punch) holes. Drill holes in the marked locations.
  - Metal door: Use a #13 (.185") or 3/16" (.188") drill bit.
  - Wood door: Use a 5/32" (.156") drill bit.

6. Fasten door leaf to door using a #3 Phillips drive and fasteners provided.

### C. Attach Door to Frame

7. Position door at 90 degrees to the frame. Wedge the door to the proper height so the door aligns with the top screw holes.
8. Install two screws at the top of the hinge. Remove the wedge and align the remaining holes. Insert screws into the middle and the bottom two holes.
9. Check the door for proper swing and clearance. Then install the remaining screws.

### D. Fastener Installation for 90-Minute Fire-Rated Wood Door

- A. Install a fastener in only one of the holes in each pair of holes at the top and bottom of the door leaf. DO NOT install the remaining screws in the three-pair hole patterns on the door leaf. See illustration below.

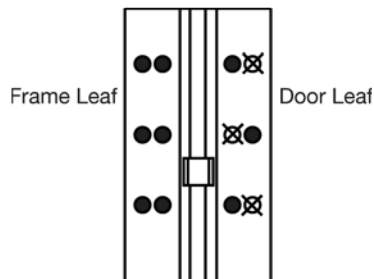

- B. Install all of the fasteners on the frame leaf.

### Reinforcing & Rivnuts®

No hinge reinforcement is necessary except on extremely high-frequency, extremely heavy or extra-wide doors. Rivnuts are recommended for use in the frame when the door exceeds 450 lb. (max. 600 lb.)

**NOTE:** Only PBB steel Rivnuts are to be used with fire-rated PBB hinges.

### Grouted/Slushed-in Frames

For ease of installation, it is recommended some sort of mudguard be installed behind the frame. Do not use self-drilling, threadforming screws to drill into grouted frames. If mudguards have not been used, carefully drill pilot holes through frame and remove grout for screw clearance. Do not oversize holes in frame.

### Fire-Rated Hinges

All stock PBB hinges are 90 minute UL-rated, without pins. Please contact PBB for complete information about its fire-rated hinges.

FIG. 1 DOOR CLOSED POSITION

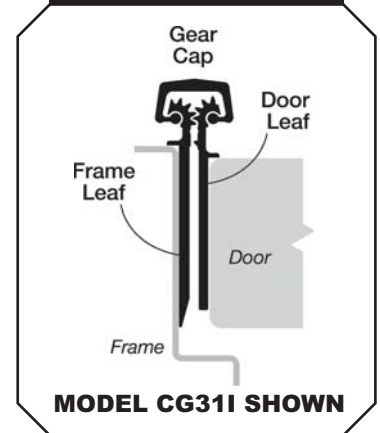

FIG. 2 DOOR OPEN 90°

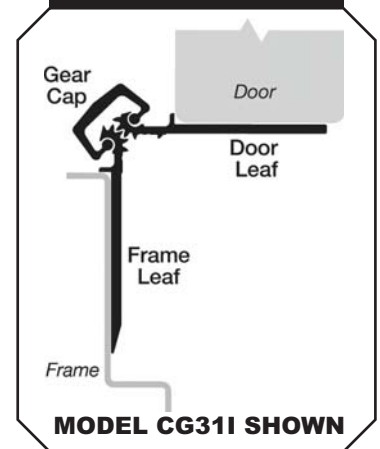
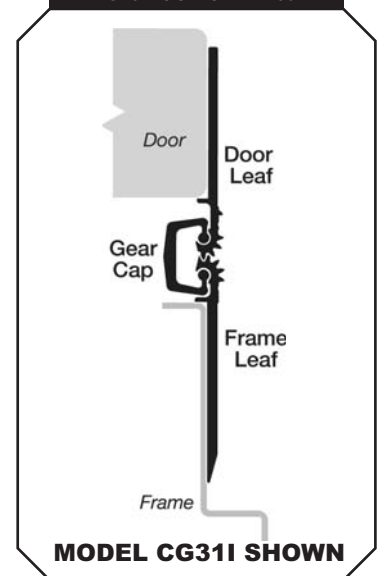

FIG. 3 DOOR OPEN 180°





# INSTALLATION INSTRUCTIONS



**CG33C**

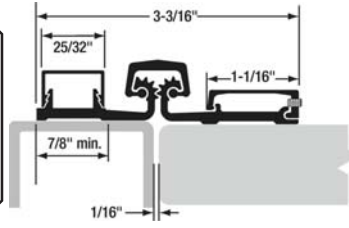

**CG33N**

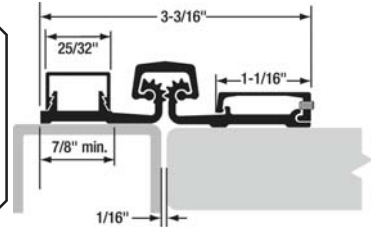

**NOTE:** Model CG33C requires repositioning of existing overhead closer(s) to match the swing clear pivot point of the hinge. Failure to do so will prevent the door from opening more than 70 degrees. Attach hinge leaf cover before reinstalling closer(s).

**NOTE:** Model CG33N requires a minimum 7/8" frame face width for mounting. On wider frames, mark a line at 1" to 1-5/16" from center of clearance between frame and closed door. Align the edge of the hinge frame leaf with mark.

## Calculating Required Door Clearances

### For Square and Beveled-Edge Doors

**IMPORTANT:** All standard length PBB hinges are supplied slightly shorter than nominal door height to avoid threshold or flooring clearance problems.

**IMPORTANT:** CG33C and CG33N are non-handed and templated. They remain non-handed after cutting. Use the same hinge model for either right-hand or left-hand openings.

**IMPORTANT:** Refer to NFPA 80 manual for clearance requirements on fire-rated entrances.

#### SINGLE DOOR: Square Edge

Hinge side clearance	0"
Latch side clearance	1/8"
Frame variance clearance	1/16"
<b>Total Width Clearance</b>	<b>3/16"</b>

**To determine door width:** - - - - -  
 Subtract the Total Width Clearance from the width of the frame opening.

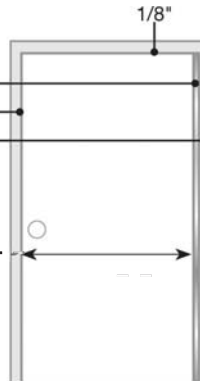

#### DOUBLE DOOR (PAIR): Square Edge

Hinge side clearance (2x)	5/16"
Latch side clearance	3/16"
Frame variance clearance	1/16"
Frame variance clearance	1/16"
<b>Total Width Clearance</b>	<b>7/8"</b>

**To determine door width:** - - - - -  
 Subtract the Total Width Clearance from the width of the frame opening; divide the result by 2.

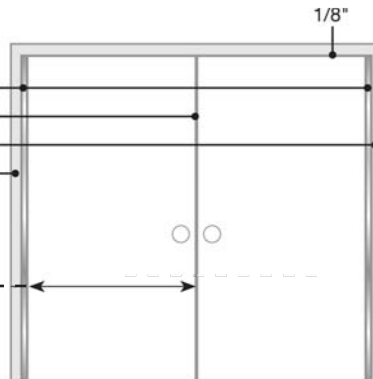

**NOTE:** For double-door entrances with a mullion between the pair of doors, calculate each door width using the Single Door clearances. For double-door entrances with a mullion behind the pair of doors, calculate each door width using the Double Doors clearances.

### Important Warranty Information:

The following actions will void any warranty, expressed or implied:

- Failure to install the hinge according to the Installation Instructions supplied with every PBB hinge.
- Use of fasteners other than those supplied with the hinge.
- Unauthorized field modifications, including alteration or removal of the factory-applied lubricant, altering the original finish or painting the hinge.



# INSTALLATION INSTRUCTIONS

## Tools Needed

- Metal-cutting saw
- #13 or 3/16" drill bit
- 3/8" drill bit
- 5/32" drill bit (wood frames only)
- #3 Phillips drive
- 5/64" Allen wrench
- Hammer
- Shims

## Parts Supplied

- #12-24x1/2" 410 SS thread-forming phillips undercut flathead screws
- 1-1/2" barrel nuts (sexnuts)
- 1/4-20x1-1/16" shoulder screws
- Striker pins

## Optional Parts

- #12x1-1/2" 410 SS Phillips undercut flathead wood screws
- 1-3/4" barrel nuts for 2" to 2-1/4" thick doors

## How to Cut the Hinge to Fit

1. Keep hinge in the "door closed" position (Fig. 1).
2. Using a metal-cutting saw, begin the cut through the hinge cap first.
3. Remove leaf covers by sliding off from uncut end of hinge.
4. Reinstall any set screw bearing that may have been cut off.

## A. Attach Hinge to Frame

1. Use shims to position the hinge 1/8" below the header to allow for door clearance.
2. Hold hinge in the "door open" position (Fig. 2) and align the frame leaf with the inner edge of door frame or your alignment mark.
3. Mark (or center punch) one hole at top and one hole at bottom of frame leaf. Drill holes at marked locations.
  - Metal door frame: Use a #13 (.185") or 3/16" (.188") drill bit.
  - Wood door frame: Use a 5/32" (.156") drill bit.
4. Fasten frame leaf to door frame.
  - Metal door frame: Use #12-24 fl at head screws provided.
  - Wood door frame: Use #12x1-1/2 fl at head wood screws (provided upon request).

## B. Prepare Door

5. Shim door into opening to provide required clearances.
6. With #3 Phillips drive, temporarily fasten the door to door leaf through at least two of the four locator holes with the pan head Tek (self-drilling) screws provided.
7. Remove shims and check door clearances.

**NOTE:** Door may sag slightly when shims are removed. Note the amount of adjustment needed to bring door back into alignment.

8. Mark locations for top and bottom barrel nuts on the door using 3/8" striker pin.
9. Remove the door; drill two holes for barrel nuts with a 3/8" drill bit.

## C. Attach Door to Hinge

10. Fasten the door to the door leaf with the top and bottom barrel nuts and two 1/4-20 shoulder screws.
11. Adjust frame leaf as needed to correct door alignment and assure proper door operation.
12. Mark (or center punch) remaining frame leaf hole locations. Drill holes in frame through the frame leaf and secure with flat head screws.
13. Mark remaining 3/8" holes on door through the door leaf. It is recommended that the door be removed and laid on horizontal surface to be sure holes are drilled squarely through both door faces.
14. Secure door to door leaf with barrel nuts and 1/4-20 shoulder screws.

## D. Install Leaf Covers

- A. Back out the set screws from side of door leaf cover with 5/64" Allen wrench (Fig. 3).
- NOTE:** For added security, construction adhesive may be applied to inside of leaf cover before installing.
- B. Align the end of the leaf cover with the top end of the hinge.
- C. Starting from the top, apply pressure along the length of the cover, snapping it into place as you move downward (Fig. 3).

**NOTE:** CG33N frame leaf cover is a press fit. Use a hammer to tap cover into place, being sure to protect the surface of the cover from damage.

- D. Tighten set screws using 5/64" Allen wrench.

## Reinforcing & Rivnuts®

No hinge reinforcement is necessary except on extremely high-frequency, extremely heavy or extra-wide doors. Rivnuts are recommended for use in the frame when the door exceeds 450 lb. (max. 600 lb.)

**NOTE:** Only PBB steel Rivnuts are to be used with fire-rated PBB hinges.

## Grouted/Slushed-in Frames

For ease of installation, it is recommended some sort of mudguard be installed behind the frame. Do not use self-drilling, threadforming screws to drill into grouted frames. If mudguards have not been used, carefully drill pilot holes through frame and remove grout for screw clearance. Do not oversize holes in frame.

## Fire-Rated Hinges



All stock PBB hinges are 90 minute UL-rated, without pins. Please contact PBB for complete information about its fire-rated hinges.

## CG33C-CG33N

FIG. 1 HINGE INSTALLED DOOR CLOSED POSITION

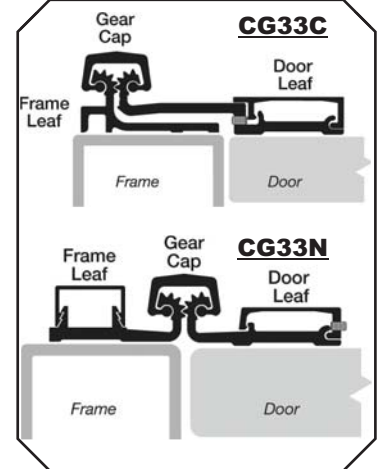

FIG. 2 DOOR OPEN POSITION LEAF COVERS REMOVED

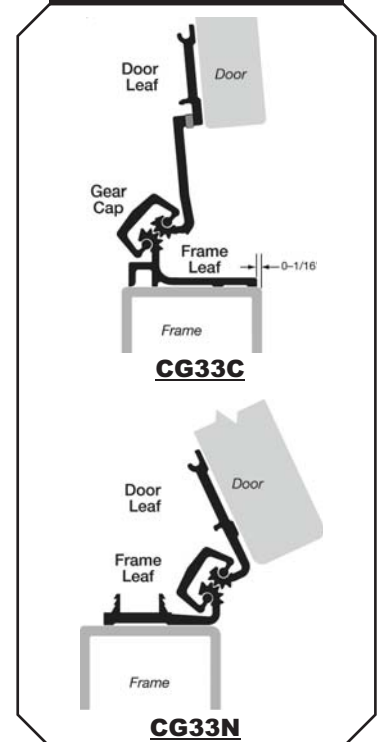
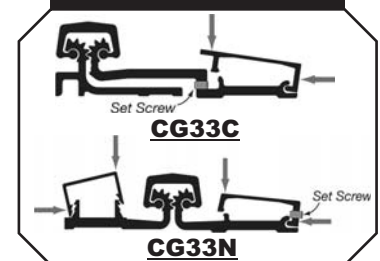

FIG. 3 LEAF COVER INSTALLATION







# INSTALLATION INSTRUCTIONS

CG31CL

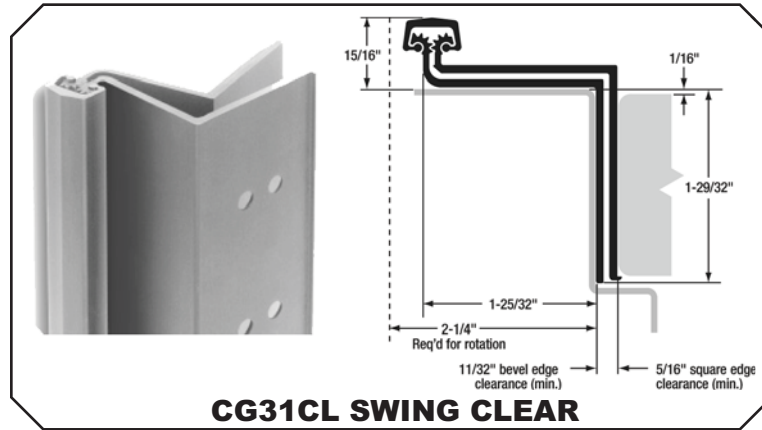

## Calculating Required Door Clearances

### For Square and Beveled-Edge Doors

**IMPORTANT:** All standard length PBB hinges are supplied slightly shorter than nominal door height to avoid threshold or flooring clearance problems. CG31CL becomes handed after cutting.

**IMPORTANT:** Refer to NFPA 80 manual for clearance requirements on fire-rated entrances.

**SINGLE DOOR: Square Edge**

Hinge side clearance	5/16"
Latch side clearance	1/8"
Frame variance clearance	1/32"
<b>Total Width Clearance</b>	<b>15/32"</b>

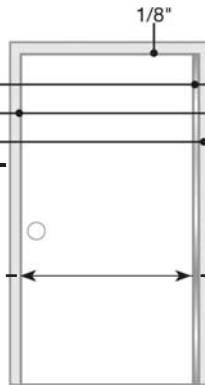

**To determine door width:** - - - -  
Subtract the Total Width Clearance from the width of the frame opening.

**SINGLE DOOR: Beveled Edge**

Hinge side clearance	5/16"
Latch side clearance	1/8"
Frame variance clearance	1/32"
Beveled edge clearance	1/32"
<b>Total Width Clearance</b>	<b>1/2"</b>

**To determine door width:**  
Subtract the Total Width Clearance from the width of the frame opening.

**DOUBLE DOOR (PAIR): Square Edge**

Hinge side clearance (2x)	5/16"
Latch side clearance	3/16"
Frame variance clearance	1/32"
Frame variance clearance	1/32"
<b>Total Width Clearance</b>	<b>7/8"</b>

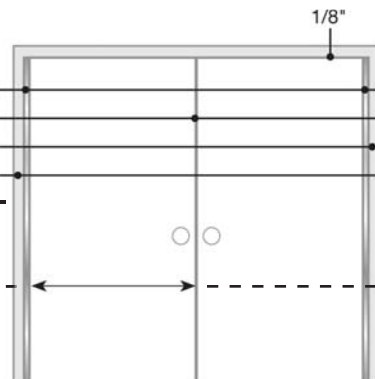

**To determine door width:** - - - -  
Subtract the Total Width Clearance from the width of the frame opening; divide the result by 2.

**DOUBLE DOOR (PAIR): Beveled Edge**

Hinge side clearance (2x)	5/16"
Latch side clearance	3/16"
Frame variance clearance	1/16"
Beveled edge clearance	1/16"
<b>Total Width Clearance</b>	<b>15/16"</b>

**To determine door width:**  
Subtract the Total Width Clearance from the width of the frame opening; divide the result by 2.

**NOTE:** For double-door entrances with a mullion between the pair of doors, calculate each door width using the Single Door clearances. For double-door entrances with a mullion behind the pair of doors, calculate each door width using the Double Doors clearances.

### Important Warranty Information:

The following actions will void any warranty, expressed or implied:

- Failure to install the hinge according to the Installation Instructions supplied with every PBB hinge.
- Use of fasteners other than those supplied with the hinge.
- Unauthorized field modifications, including alteration or removal of the factory-applied lubricant, altering the original finish or painting the hinge.



# INSTALLATION INSTRUCTIONS

CG31CL

## Tools Needed

- Metal-cutting saw
- Tape measure
- #13 or 3/16" drill bit
- 5/32" drill bit (wood frames/doors)
- #3 Phillips drive
- Shims

## Parts Supplied

- #12-24 x 1/2" 410 SS thread-forming Phillips undercut flathead screws

## Optional Parts

- #12 x 1-1/2" 410 SS Phillips flathead undercut wood screws
- #12-24 x 3/4" 410 SS Phillips self-drilling thread forming (SDTF) undercut flathead screws

## How to Cut the Hinge to Fit

1. Keep hinge in the "door closed" position (Fig. 1).
2. Determine whether this will be a right- or left-hand installation. You will install the cut end at the bottom.
3. DO NOT cut through a set-screw bearing. Reinstall or relocate the set-screw bearing if necessary.
4. Using a metal-cutting saw, begin the cut through the gear cap first.

## A. Prepare Frame

1. Use shims to position the hinge 1/8" below the header to allow for door clearance.
2. Hold hinge in the "door open" position (Fig. 2) making sure the frame leaf alignment flange is tight against the frame face.
3. Mark (or center punch) hole locations. Drill holes at marked locations.
  - Metal door frame: Use a #13 (.185") or 3/16" (.188") drill bit.
  - Wood door frame: Use a 5/32" (.156") drill bit.

**IMPORTANT:** DO NOT attach the hinge to the frame at this time.

## B. Attach Door to Hinge

4. Align the door leaf alignment flange or the door leaf lip along the full length of the door edge (even if the door is slightly warped).

**IMPORTANT:** Top end of the hinge must be flush to a straight edge across the top of the door.

5. Mark (or center punch) holes. Drill holes in the marked locations.
  - Metal door: Use a #13 (.185") or 3/16" (.188") drill bit.
  - Wood door: Use a 5/32" (.156") drill bit.
6. Fasten door leaf to door using a #3 Phillips drive and fasteners provided.

## C. Attach Door to Frame

7. Position door at 90 degrees to the frame. Wedge the door to the proper height so the door aligns with the top screw holes.
8. Install two screws at the top of the hinge. Remove the wedge and align the remaining holes. Insert screws into the middle and the bottom two holes.
9. Check the door for proper swing and clearance. Then install the remaining screws.

## D. Fastener Installation for 90-Minute Fire-Rated Wood Door

- A. Install a fastener in only one of the holes in each pair of holes at the top and bottom of the door leaf. DO NOT install the remaining screws in the three-pair hole patterns on the door leaf. See illustration below.

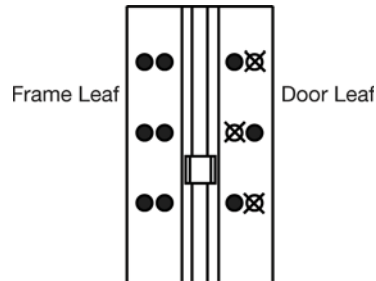

- B. Install all of the fasteners on the frame leaf.

## Reinforcing & Rivnuts®

No hinge reinforcement is necessary except on extremely high-frequency, extremely heavy or extra-wide doors. Rivnuts are recommended for use in the frame when the door exceeds 450 lb. (max. 600 lb.)

**NOTE:** Only PBB steel Rivnuts are to be used with fire-rated PBB hinges.

## Grouted/Slushed-in Frames

For ease of installation, it is recommended some sort of mudguard be installed behind the frame. Do not use self-drilling, threadforming screws to drill into grouted frames. If mudguards have not been used, carefully drill pilot holes through frame and remove grout for screw clearance. Do not oversize holes in frame.

## Fire-Rated Hinges

All stock PBB hinges are 90 minute UL-rated, without pins. Please contact PBB for complete information about its fire-rated hinges.

FIG. 1 DOOR CLOSED POSITION

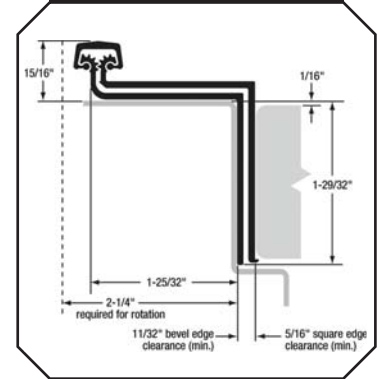
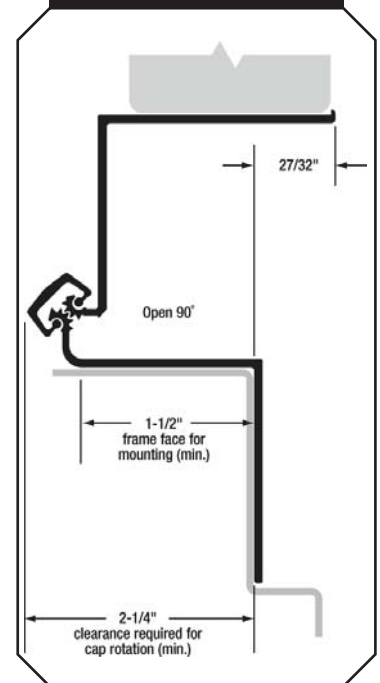

FIG. 2 DOOR OPEN 90°





# INSTALLATION INSTRUCTIONS



**CG34N**

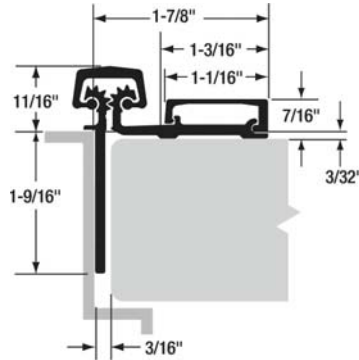

**CG34**

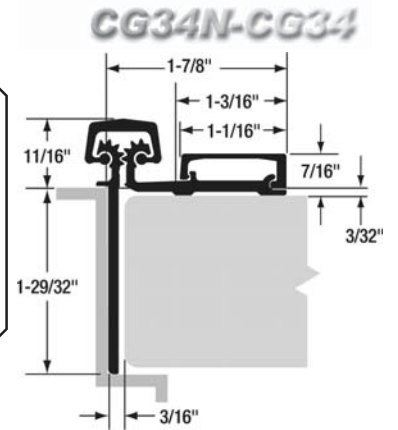

## Calculating Required Door Clearances

### For Square and Beveled-Edge Doors

**IMPORTANT:** All standard length PBB hinges are supplied slightly shorter than nominal door height to avoid threshold or flooring clearance problems.

**IMPORTANT:** Refer to NFPA 80 manual for clearance requirements on fire-rated entrances.

### SINGLE DOOR: Square Edge

Hinge side clearance	5/32"
Latch side clearance	1/8"
Frame variance clearance	1/32"

**Total Width Clearance 5/16"**

**To determine door width:** - - - - -  
Subtract the Total Width Clearance from the width of the frame opening.

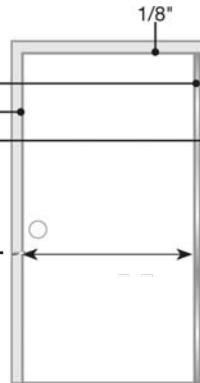

### DOUBLE DOOR (PAIR): Square Edge

Hinge side clearance (2x)	5/32"
Latch side clearance	3/16"
Frame variance clearance	1/16"

**Total Width Clearance 9/16"**

**To determine door width:** - - - - -  
Subtract the Total Width Clearance from the width of the frame opening; divide the result by 2.

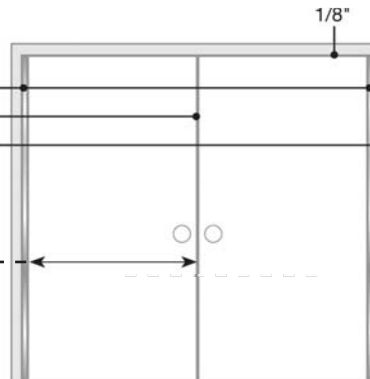

**NOTE:** For double-door entrances with a mullion between the pair of doors, calculate each door width using the Single Door clearances. For double-door entrances with a mullion behind the pair of doors, calculate each door width using the Double Doors clearances.

### Important Warranty Information:

The following actions will void any warranty, expressed or implied:

- Failure to install the hinge according to the Installation Instructions supplied with every PBB hinge.
- Use of fasteners other than those supplied with the hinge.
- Unauthorized field modifications, including alteration or removal of the factory-applied lubricant, altering the original finish or painting the hinge.



# INSTALLATION INSTRUCTIONS

## Tools Needed

- Metal-cutting saw
- #13 or 3/16" drill bit
- 3/8" drill bit
- 5/32" drill bit (wood frames only)
- #3 Phillips drive
- 5/64" Allen wrench
- Hammer
- Shims

## Parts Supplied

- #12-24x1/2" 410 SS thread-forming phillips undercut flathead screws
- 1-1/2" barrel nuts (sexnuts)
- 1/4-20x1-1/16" shoulder screws
- Striker pins

## Optional Parts

- #12x1-1/2" 410 SS Phillips undercut flathead wood screws
- 1-3/4" barrel nuts for 2" to 2-1/4" thick doors

## How to Cut the Hinge to Fit

- Keep hinge in the "door closed" position (Fig. 1).
- Determine whether this will be a right- or left-hand installation. Install the cut end at the bottom.
- Using a metal-cutting saw, begin the cut through the hinge cap first.

**IMPORTANT:** Cut only one end. This maintains the original templated six-hole pattern at the top of the hinge. It also allows any chips to work their way out after installation.

- Remove leaf covers by sliding off from uncut end of hinge.
- Reinstall any set screw bearing that may have been cut off.

## A. Attach Hinge to Frame

- Hold hinge in the "door open" position (Fig. 2).
- Use a shim to position the top end of the hinge 1/8" below the header to allow for door clearance. Align the frame leaf alignment flange tightly against the frame face.
- Mark (or center punch) one hole at top and one hole at bottom of frame leaf. Drill holes at marked locations.
  - Metal door frame: Use a #13 (.185") or 3/16" (.188") drill bit.
  - Wood door frame: Use a 5/32" (.156") drill bit.
- Fasten frame leaf to door frame.
  - Metal door frame: Use #12-24 fl at head screws provided.
  - Wood door frame: Use #12x1-1/2 flat head wood screws (optional).

## B. Prepare Door

- Shim door into opening to provide required clearances.
- With a #3 Phillips drive, temporarily fasten

the door leaf to the door by inserting the pan head Tek (self-drilling) screws into at least two of the four locator holes.

- Remove shims and check door clearances.
 

**NOTE:** Door may sag slightly when shims are removed. Make necessary adjustments needed to bring door back into alignment.
- Mark locations for top and bottom barrel nuts on the door using 3/8" striker pin.
- Remove door and lay on horizontal surface. Use a 3/8" drill bit to drill holes at marked locations.

**NOTE:** Be sure to drill holes squarely through both door faces.

## C. Attach Door to Hinge

- Fasten the door to the door leaf with the top and bottom barrel nuts and two 1/4-20 shoulder screws.
- Adjust frame leaf as needed to correct door alignment and assure proper door operation.
- Mark (or center punch) remaining frame leaf hole locations. Drill holes in frame through the frame leaf and secure with flat head screws.
- Mark remaining 3/8" holes on door through the door leaf. It is recommended that the door be removed and laid on horizontal surface to be sure holes are drilled squarely through both door faces.
- Secure door to door leaf with barrel nuts and 1/4-20 shoulder screws.

## D. Install Leaf Covers

- Loosen set screws from side of door leaf cover (Fig. 3) using 5/64th Allen wrench.
 

**NOTE:** For added security, apply a bead of construction or panel adhesive inside the leaf cover or over the barrel nut heads before installation.
- Align the end of the leaf cover with the top end of the hinge.
- Starting at the top, apply pressure along the length of the cover, snapping it into place as you move downward (Fig. 3).

**NOTE:** Protect cover surface from damage if you use a hammer to tap it into place.

- Use a 5/64" Allen wrench to securely tighten set screws.

## Reinforcing & Rivnuts®

No hinge reinforcement is necessary except on extremely high-frequency, extremely heavy or extra-wide doors. Rivnuts are recommended for use in the frame when the door exceeds 450 lb. (max. 600 lb.)

**NOTE:** Only PBB steel Rivnuts are to be used with fire-rated PBB hinges.

### CG34N-CG34

FIG. 1 DOOR CLOSED POSITION

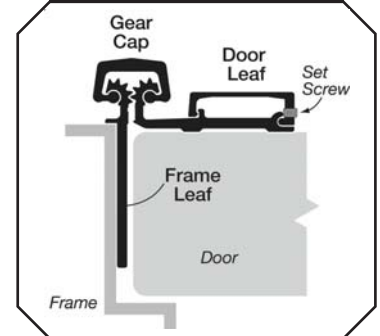

FIG. 2 DOOR OPEN 90°

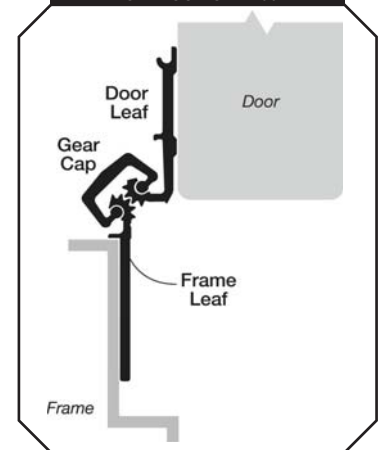
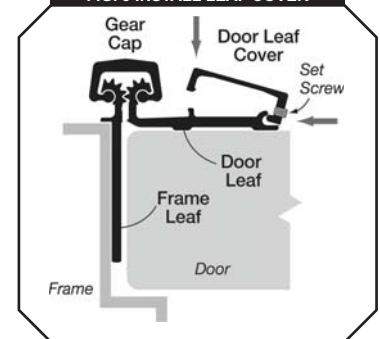

FIG. 3 INSTALL LEAF COVER



## Grouted/Slushed-in Frames

For ease of installation, it is recommended some sort of mudguard be installed behind the frame. Do not use self-drilling, threadforming screws to drill into grouted frames. If mudguards have not been used, carefully drill pilot holes through frame and remove grout for screw clearance. Do not oversize holes in frame.

## Fire-Rated Hinges



All stock PBB hinges are 90 without pins. Please contact PBB for complete minute UL-rated, information about its fire-rated hinges.



# POWER TRANSFER ORDER FORM

Hinge Model:	
<b>Power Transfer Selection</b>	
<input type="checkbox"/> Adams Rite 4612-1 <input type="checkbox"/> Securitron EPT <input type="checkbox"/> Yale EPT <input type="checkbox"/> RCI 9512 <input type="checkbox"/> Dorma ES105 <input type="checkbox"/> Folger Adams EPT <input type="checkbox"/> Von Duprin	<input type="checkbox"/> Adams Rite 4612-2 <input type="checkbox"/> Securitron EPTL <input type="checkbox"/> Yale EPTL <input type="checkbox"/> RCI 9513 <input type="checkbox"/> Precision EPT-5 <input type="checkbox"/> Folger Adams EPTL <input type="checkbox"/> Other _____
<b>CUTOUT SHAPE (MATCH EP MOUNTING FLANGE):</b>	<b>CUTOUT LOCATION:</b>
<input type="checkbox"/> Round End <input type="checkbox"/> Square End	<input type="checkbox"/> Door Leaf <input type="checkbox"/> Both Leaves <input type="checkbox"/> Frame Leaf
<b>HANDING (FROM KEYED SIDE):</b>	
<input type="checkbox"/> Right Hand <input type="checkbox"/> Right Hand Reverse	<input type="checkbox"/> Left Hand <input type="checkbox"/> Left Hand Reverse
COMPANY:	
APPROVED BY:	
DATE:	
DOOR MARKINGS:	
P.O. NUMBER	
<p><b>PREPS:</b> PBB continuous hinges can be prepared for electric power transfer. Others available upon request. Contact factory for quotes and availability on preparations for power transfer units.</p> <p><b>LOCATION:</b> Specify the dimension from the top of the hinge to the centerline of the cutout. Geared hinge is installed flush with the top of the door. Pin and barrel hinge is positioned 1/8" (3.2mm) below the header.</p> <p><b>HANDING:</b> Specify the handing of each door requiring the EP.</p> <p><b>ORDER:</b> Use suffix "EP" plus the location (and handing if required).</p> <p><b>LEAD TIME:</b> Call PBB for manufacturing lead times.</p> <p><b>IMPORTANT:</b> PBB, Inc. does not recommend preparing door and frame for EP before receipt of hinge. If door and frame must be prepared before receipt of hinge, contact factory for special template.</p>	

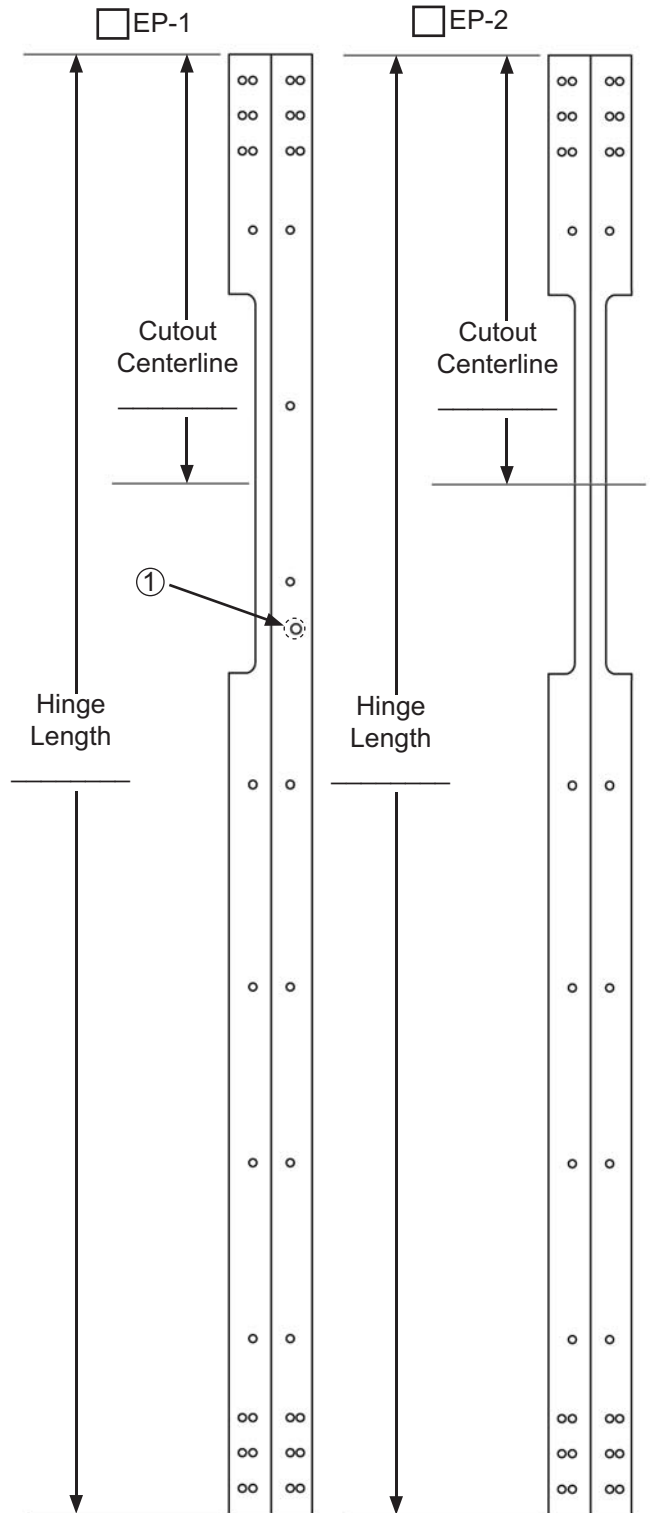

① Open end of EP flexible conduit mounting hole is customer's sole responsibility. Contact PBB, Inc. for technical assistance.

Please fill out this form and fax it to PBB, Inc.  
1-888-722-8592



### DUTCH DOOR HINGE ORDER FORM

Customer:

P.O. No.

Model:

Qty.

I, the undersigned, approve the design and dimensions as shown on this print, and authorize the fabrication of these Continuous Hinges as indicated.

Date:

Signed:

HINGE SIDE

Top Of Door

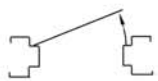
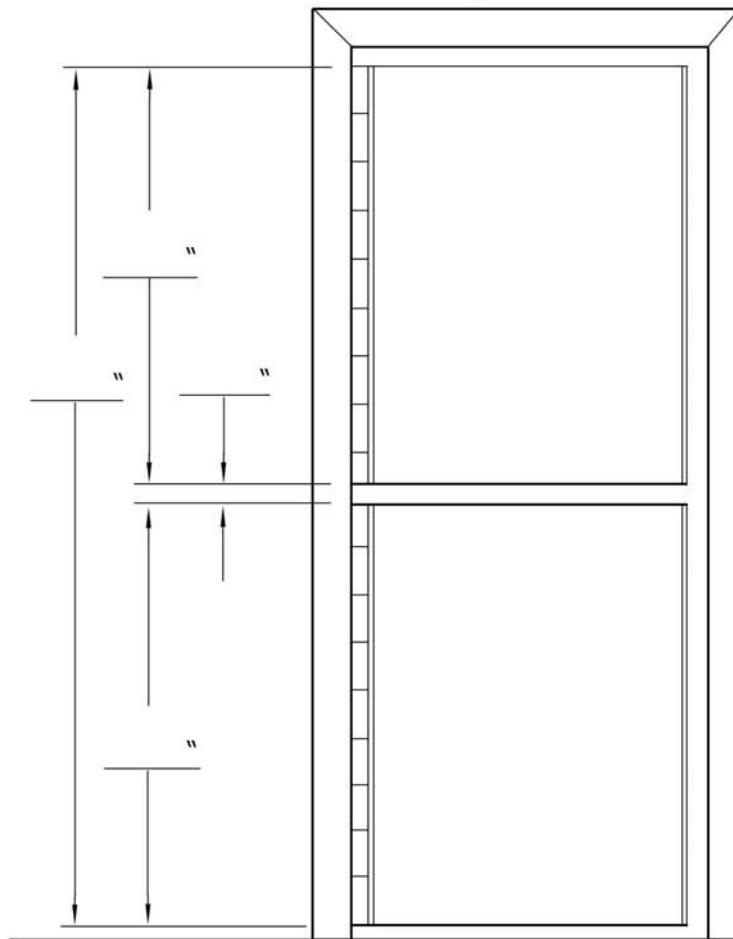

LEFT HAND



RIGHT HAND

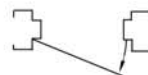

LEFT HAND  
REVERSE



RIGHT HAND  
REVERSE



## ELECTRIC HINGE - E

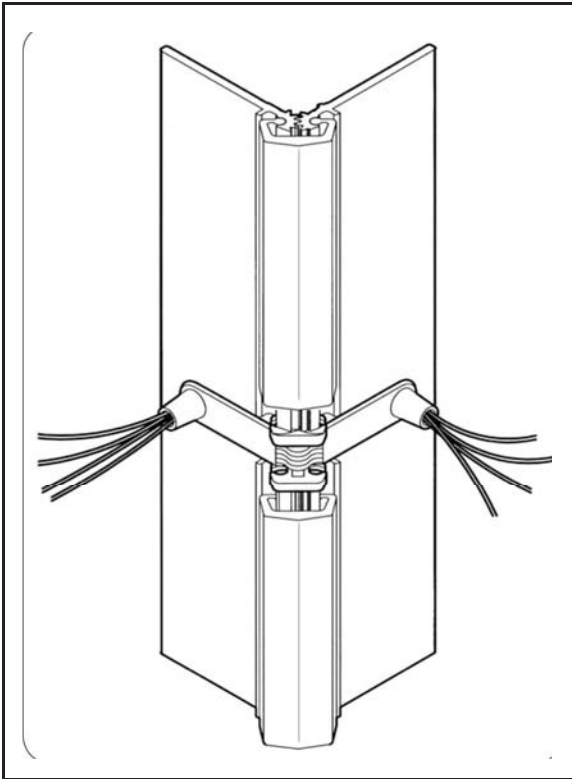

**PREPS:** PBB geared continuous hinges can be prepared for concealed electric through-wires to provide continuous current. Through-wires available in sets of 4, 5, 8 or 10 (12-wire sets available upon engineering approval). 22 gauge wire with 8" leads (approx). 120V AC/DC at 3-6 amps per conductor.

**NOTE:** E4 and E5 preps require the replacement of one hinge bearing with a special bearing containing wires; E8 and E10 preps require the replacement of two bearings; E12 prep requires the replacement of three bearings.

**LOCATION:** Specify the dimension from the top of the hinge to E centerline. Hinge is installed flush with the top of the door. Refer to the "Fastener Hole and Bearing Locations" in the Concealed hinge section to choose bearing location(s).

**HANDING:** Specify the handing of each door requiring the E. Handing not required on CG31 and CG31P.

**ORDER:** Use suffix "E" plus the number of wires required. Indicate location of the E (and handing if required). Example: CG31L HD 83" Clear E4 42-25/32" from top of hinge, RH.

**AVAILABILITY:** Available on geared hinge models CG31, CG31I, CG31L, CG31PN, and CG31P.

**LEAD TIME:** 48 Hours (on most orders).

**WARRANTY:** 5 years on electrical modification components.

**IMPORTANT:** PBB Products Limited does not recommend preparing door and frame for E before receipt of hinge. If door and frame must be prepared before receipt of hinge, contact factory for special template.

## ELECTRIC MONITOR - EM - CALL FACTORY FOR PRICING

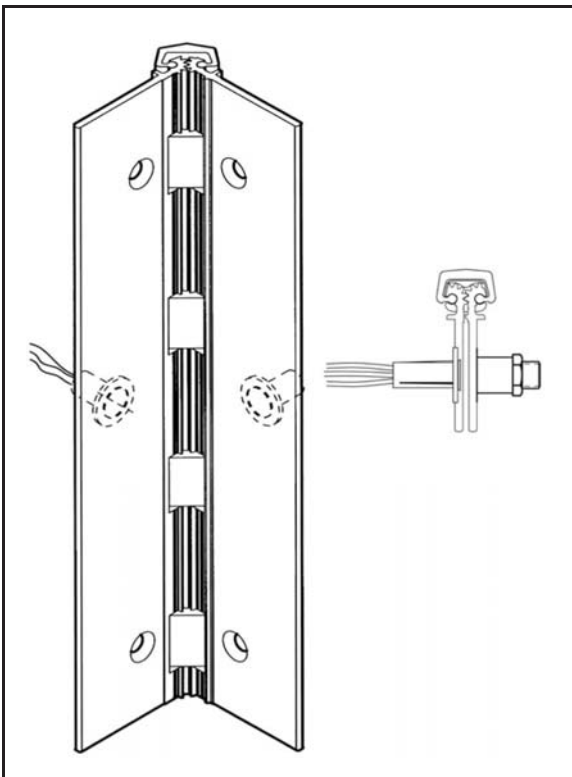

**PREPS:** PBB geared continuous hinges can be prepared for a concealed magnetic monitor switch to provide noncontinuous current. 22 gauge wire with 12" leads (approx). 30V DC. Maximum current 100A, maximum contact rating 20W.

**LOCATION:** Using template provided, specify the dimension from the top of the hinge to switch. Avoid putting switch within one inch of a fastener hole. Hinge is installed flush with the top of the door.

**HANDING:** Specify the handing of each door requiring the EM. order: Use suffix "EM" plus the location of the switch (and handing if required). Only one switch required. Example: CG31L HD 83" Clear EM 36" from top of hinge, RH.

**AVAILABILITY:** Available on geared hinge models CH31, CG31I, CG31L, CG31PN, CG31P, and CG31CL.

**LEAD TIME:** 48 hours (on most orders).

**WARRANTY:** 5 years on electrical modification components.

**IMPORTANT:** PBB Products Limited does not recommend preparing door and frame for EM before receipt of hinge. If door and frame must be prepared before receipt of hinge, contact factory for special template.



## REMOVABLE HINGE LEAF PANEL - R



**PREPS:** PBB geared continuous hinges can be prepared with removable hinge leaf panels to allow easy access to electrical components without removing door.

**LOCATION:** Dimensions will differ depending on the hinge model and electrical components requested. A template requiring customer's approval will be designed by a PBB engineer based on the customer's order. Hinges are installed flush with the top of the door.

**HANDING:** Specify the handing of each door requiring the R.

**ORDER:** Use suffix "R" (Removable Panel), plus handing. Example: CG31L HD 83" Clear E4 42-25/32" from top of hinge to centerline, R, RH.

**AVAILABILITY:** Available on geared hinge models CG31, CG31I, CG31L, CG31PN, CG31P.

**LEAD TIME:** 48 hours (on most orders).

**IMPORTANT:** *PBB Products Limited does not recommend preparing door and frame for "R" before receipt of hinge. If door and frame must be prepared before receipt of hinge, contact factory for special template.*

**DUTCH DOOR PREP** - Available on all hinge models. Continuous frame leaf with two-piece door leaf. Indicate handing, clearance, door and frame heights, and materials when ordering. Separate dutch door order form required. Suffix - "D"

**HOSPITAL TIP** - Available on all models. Suffix - "H"

**ELECTRIC TRANSFER PREP** - Centerline of hinge is standard location. Hinge leaf cutout to accommodate power transfer harness made by other manufacturers. *Separate EP order form required. Single Cutout (EP-1) and Dual Cutout (EP-2) Suffix - "EP"*

## MOVABLE HINGE LEAF PANEL - M

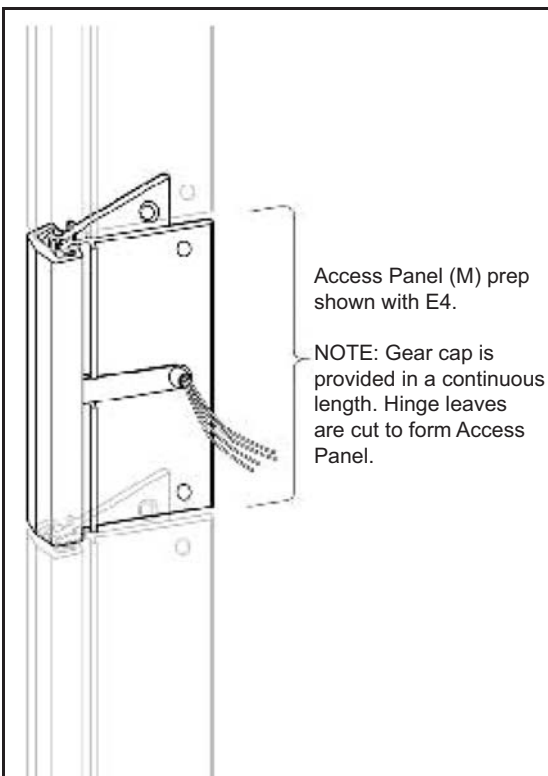

**PREPS:** PBB geared continuous hinges can be prepared with hinge leaf panels to allow easy access to electrical components.

**LOCATION:** Dimensions will differ depending on the hinge model and electrical components requested. A template requiring customer's approval will be designed by a PBB engineer based on the customer's order. Hinges are installed flush with the top of the door.

**HANDING:** Specify the handing of each door requiring the M.

**ORDER:** Use suffix "M" (Access Panel), plus handing. Example: CG31L HD 83" Clear E4 42-25/32" from top of hinge to centerline, M, RH.

**AVAILABILITY:** Available on geared hinge models CG31, CG31I, CG31L, CG31PN, CG31P.

**LEAD TIME:** 48 hours (on most orders).

**IMPORTANT:** *PBB Products Limited does not recommend preparing door and frame for "M" before receipt of hinge. If door and frame must be prepared before receipt of hinge, contact factory for special template.*





## CROSS REFERENCE

PBB	ROTON	SELECT	PEMKO	MCKINNEY	ZERO	STANLEY	MARKAR	IVES
CG31L	780-224	SL24	FM	MCK-25	914	662	FM-2011	224HD
CG31PN	~~	SL26	~~	~~	~~	~~	~~	~~
CG31I	780-111	SL18	FMSLI	MCK-14	~~	~~	~~	~~
CG31	780-112	SL11	FMSLF	MCK-12	910	661	FM-2000	112HD
CG31P	780-226	SL27	FMSLF	~~	~~	~~	~~	~~
CG31CL	780-041	SL41	~~	~~	~~	~~	~~	~~
CG33N	780-157	SL57	FSCP	MCK-58	935	664	FS-2002	157HD
CG33C	780-210	SL21	FS	MCK-22	930	665	FS-2009	210HD
CG34N	780-053	SL53	~~	~~	925	~~	~~	~~
CG34	780-054	SL54	HSHD	MCK-54	~~	663HD	HS2003	~~

HOW TO ORDER:	EXAMPLE: CG31C83628
1st - 2nd	Digits indicates series
3rd	Digit indicates material
4th	Digit indicates type
5th - 6th	Digits indicates special function
7th - 9th	Digits indicates lengths
10th	Digit indicates finish
11th	Digit indicates options

CG = Continuous Gear
3 = Aluminum, 5 = Stainless Steel
1 = Full Mortise, 2 = Half Mortise, 3 = Full Surface, 4 = Half Surface
C = Swing Clear, G=Edge Guard, I = 1/8" Inset
79", 83", 85", 95", 120"
630 = Satin Stainless, 629 = Polish Stainless Steel
E = Concealed Electric Through Wire, EP = Electric Power Transfer

### OPTIONS

- F - For fire rated doors, indicate door rating
- Electrical Hinge Modification
  - EC - Exposed Electrical Contacts. Indicate number of contacts, handing
  - EM - Concealed Electric Monitoring. Indicate handing
  - WM - Concealed Electric Through Wire and Monitoring. Indicate number of wires and handing
  - EP - Power Transfer - Specify dimension from the top of the hinge to the centerline of the power transfer cut-out, handing
  - M - 1 Piece Gear Hinge with movable thru wire portion
  - R - 3 Section Gear Hinge with Removable thru wire portion

Screw Pack #	Screw Size
A	#12-24 x 1/2" Phillips Flat Head Undercut Thread Forming
B	#12-24 x 3/4" Phillips Flat Head Undercut Thread Forming
C	#12-14 x 1-1/2" Wood Screw
D	1/4-20 x 1-1/2" Sexbolt and Screw

### GUARANTEE

PBB Inc. guarantees these products to be free from defects in materials or workmanship under normal use and service for the life of the opening. PBB liability under this guarantee is limited to replacement for goods proven to be defective in material or workmanship. Claims for faulty or improper installation, consequent damages, repairs or backcharges will not be allowed. This guarantee does not cover defects or damage resulting from vandalism, abuse, improper maintenance, improper storage, shipping or handling, or painting of product in the field. PBB makes no other guarantee or warranty either expressed or implied.

### For More Information

Contact your local representative or PBB Inc., Phone (800) 726-3414 Fax (909) 923-6248  
 1311 E. Philadelphia Street, Ontario, CA 91761 Web Site: <http://www.pbbinc.com/>