

Experience a safer
and more open world



2025

Product Catalog

U.S. Prices Effective March 3, 2025

Table of Contents

Medeco

Key Control.....	3
How to Order.....	7
Online Tools.....	8
Medeco fusion.....	9
Shipping and Returns Policy.....	12
Warranty.....	13
Standard Terms and Conditions of Sale.....	14
Professional Services.....	18
Intelligent Technology Overview.....	22

Intelligent Key Systems

M³ and X4 CLIQ[®]; eCLIQ[®].....	23
Rim and Mortise Cylinders.....	24
Key-In-Knob/Lever Cylinders.....	24
Interchangeable Core Cylinders.....	26
Deadbolts.....	27
Padlocks.....	28
International Cylinders.....	30
CLIQ [™] CONNECT Keys.....	31
How to Order Medeco CLIQ [™] Keys.....	32
Keys and Accessories.....	33
Programming and Management.....	34
New CLIQ Systems Check List.....	36
Classic CLIQ[®].....	37
Rim and Mortise Cylinders.....	38
Key-In-Knob/Lever.....	39
Interchangeable Core Cylinders.....	41
Padlocks.....	41
Deadbolts.....	42
Cam and Utility Cylinders.....	43
Retail/Showcase Locks.....	43
International Cylinders.....	44
Vending Cylinder Formats.....	44
Keys and Accessories.....	45
Programming and Management.....	46
Medeco XT.....	47
Programming and Management.....	48
Intelligent Keys.....	50
Keys and Accessories.....	51
Programmings and Accessories.....	52
Rim and Mortise Cylinders.....	54
Interchangeable Core Cylinders.....	54
Key-In-Knob/Lever Cylinders.....	55
Padlocks.....	57
Specialty Cylinder Formats.....	58
Cam and Utility Cylinders.....	59
Dual-Tech Cylinder.....	60
XT Dual-Tech Cams.....	60
Traffic Cabinet Lock.....	61
XT Safe Lock.....	61
International Cylinders.....	62
XT Guard Tour Reader.....	62
Access Interface Module (AIM).....	63
Medeco Nexgen.....	64

Mechanical Technologies

Technology Overview.....	73
Medeco 4 High Security Locking System.....	74
BiLevel Technology.....	75
Medeco X4 Technology.....	76
Medeco B Technology.....	77
Product Overview.....	78

Mechanical Products

Key Management.....	65
Intelligent Key Cabinet (IKC).....	65
T21 Key Management System.....	71
SimpleK Key & Facility Management Software.....	72
Rim and Mortise Cylinders.....	79
Key-In-Knob/Lever Cylinders.....	88
Interchangeable Cores.....	109
LFIC.....	109
SFIC.....	117
Deadbolts.....	123
Maxum.....	123
Residential Maxum.....	130
Padlocks.....	131
All Weather Padlocks.....	131
System Series.....	135
50 and 52 Series Brass Body Padlocks.....	140
Hockey Puck.....	146
G8R.....	147
Cam/Cabinet and Switch Locks.....	150
Cam Locks.....	151
Removable Core Cam Locks.....	153
Cabinet Locks.....	159
Plunger Locks.....	161
Micro Switch Lock.....	162
Rotary Switch Lock.....	164
International Cylinders.....	166
Accessories.....	
Keying Charges.....	196
Keys.....	198
Pin Kits.....	199
Components.....	202
Tools and Fixtures.....	203
Key Machines.....	204
Product Index.....	205
Finishes.....	215

Key Control

Medeco's Approach

The security of any locking system is dependent upon two very important factors. The first is protection against attacks such as picking, drilling, bumping, and forcing. The second is the ability to control duplication of existing keys. Historically, unauthorized key duplication has played a major role in compromising even the most sophisticated security systems. Anyone with even temporary access to original keys has no problem getting duplicates made for their own use if the keys and key blanks are not patent protected. Even stamping "Do Not Duplicate" on a key merely warns someone not to copy the key – it is not a promise of legal protection or enforcement. The only way to ensure that keys cannot be copied without the consent of the owner is a key system with patent-protected keys.

Medeco has counteracted the key control problem by doing three things:

1. Medeco manufactures cylinders which use keys that must be made on special key cutting machines. These machines are capable of reproducing the angled cuts and critical tolerances necessary to produce a workable Medeco key, and are not found at general hardware stores.
2. Medeco only sells its high-quality, precision machined cylinders and locks to security industry professionals. Every restricted Medeco key blank is custom coined and tracked by Medeco to identify it as an authorized key blank, which protects against unauthorized copies.
3. Medeco invests heavily in research and development to establish strong patents and legal agreements to protect its locks and key blanks from unauthorized distribution or manufacture. As a result, Medeco can litigate to protect its rights and the security of its customers.

A Key Control Program That's Right for You

Not every user has the same key control needs. That's why Medeco has designed different key control programs and different keyways to meet a wide range of security specifications and key access requirements.



Dealer/Service Center

This program offers instant local access to additional keys with protection from unauthorized copying. Consumers simply return to the security provider from which they purchased the locks. This security professional will have a signature card on file completed by the owner of the key system at the time the system was installed.



Card Programs

Authorized individuals are issued a card with embossed control data and a space for their signature. To obtain key duplicates, card holders present the card to any participating Medeco security professional. The data and signature will be verified and a key can then be issued. A card program is ideal for residences or businesses that need keys available nationwide.



End User Program

The End User program is for large facilities that have their own locksmith on staff and that want to produce Medeco keys themselves. This program offers individualized control over key duplication procedures.



Commercial Program

The Commercial Program is designed for users who use Medeco locks primarily for protection against picking, drilling and other forms of physical attack. Keys may be obtained from any Medeco locksmith without specific authorization.



Factory Program

Additional keys are only available from the Medeco factory and only with the proper signature.









Intelligent Key Systems











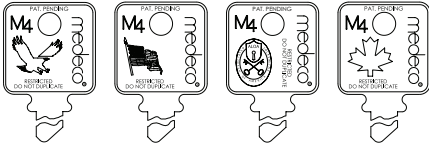





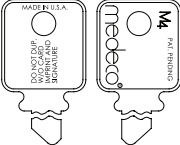

Intelligent Key Systems allow the end user the ability to control their own system to electronically change access to any cylinder or key onsite and to obtain audit information.

Visit our website at www.medeco.com for more information on all key programs.





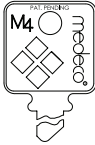





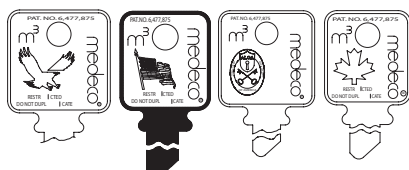



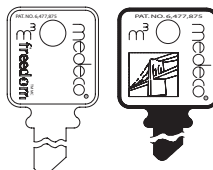

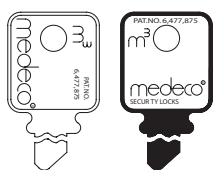

MEDECO® KEY CONTROL PROGRAM REFERENCE CHART

M4 = Medeco 4 patent expiration date: 2040.	 = Permission for copying keys is obtained by presenting a signed authorization card, which is matched to proper identification.
M3 = Medeco ³ patent expiration date: 2021. Upgrading to Medeco 4 recommended.	 = Permission for copying keys is provided by identification and signature verification, which must be presented to either the original locksmith provider or the facility manager.
BIA = Biaxial patent expiration date: 2005. Upgrading to Medeco 4 recommended.	 = Keys can be cut on-site by dealers or end-users that are contracted to participate in the respective key program.
ORG = Original patent expiration date: 1985. Upgrading to Medeco 4 recommended.	 = Keys are ordered locally and cut at a regional service center and then shipped back to the dealer.
X4 = Medeco X4 patent expiration date: 2030.	 = Keys are cut at the Medeco factory and shipped to dealer. Authorization is provided by signature verification.
KM = KeyMark patent expiration date: 2011.	 = Medeco recommended high security—UL 437 Listed, ultimate Grade 1 strength, and A156.5-2001 and A156.30 Level A Certified.

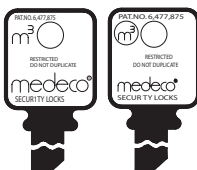



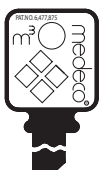





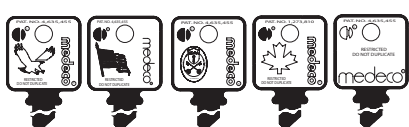

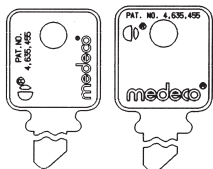
MEDECO 4® KEYWAY PROGRAMS

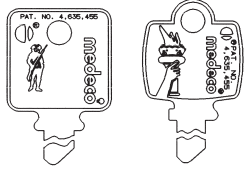
 <p>Medeco 4 Dealer</p> <p>M4   </p>	 <p>Freedom®</p> <p>M4   </p>	 <p>DND</p> <p>M4   </p>
 <p>Medeco 4 End-User</p> <p>M4   </p>	 <p>Medeco 4 Factory Restricted</p> <p>M4  </p>	











MEDECO³® KEYWAY PROGRAMS

 <p>Medeco³ Dealer</p> <p>M3   </p>	 <p>Freedom[®] / Gotham[™]</p> <p>M3   </p>	 <p>DND / NYC</p> <p>M3   </p>
 <p>Medeco³ End-User</p> <p>M3   </p>	 <p>Medeco³ Factory Restricted</p> <p>M3  </p>	

BIAXIAL KEYS

 <p>Biaxial[®] Dealer</p> <p>BIA  </p>	 <p>Gold (GLD) / Platinum (NUK)</p> <p>BIA  </p>	 <p>Patriot[®] / Liberty[™]</p> <p>BIA  </p>
 <p>Biaxial[®] End-User</p> <p>BIA  </p>	 <p>Biaxial[®] Factory Restricted</p> <p>BIA </p>	

ORIGINAL KEYS

 <p>Original[®] Dealer</p> <p>ORG  </p>	 <p>SKY</p> <p>ORG  </p>	 <p>Original[®] End-User</p> <p>ORG  </p>	 <p>Original[®] Factory Restricted</p> <p>ORG </p>
--	--	---	--

COMMERCIAL KEYS



Commercial
(Original & Biaxial Version)

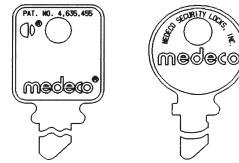

OEM / Other

Medeco keys not found on this chart are most likely from an original equipment manufacturer using Medeco products. Return to the original manufacturer of the product for duplicate keys.

MEDECO X4 KEYS

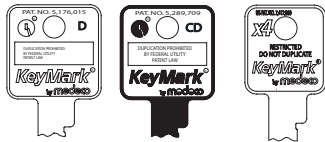



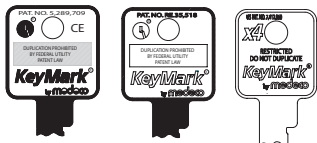

Medeco X4 Dealer



Medeco® KM/X4 End-User



REFERENCE CHART

-  = Permission for copying keys is obtained by presenting a signed authorization card, which is matched to proper identification.
-  = Permission for copying keys is provided by identification and signature verification, which must be presented to either the original locksmith provider or the facility manager.
-  = Keys can be cut on-site by dealers or end-users that are contracted to participate in the respective key program.
-  = Keys are ordered locally and cut at a regional service center and then shipped back to the dealer.
-  = Keys are cut at the Medeco factory and shipped to dealer. Authorization is provided by signature verification.



Medeco KM Silver



Medeco X4 Chrome

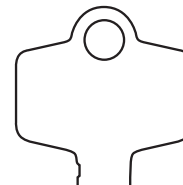

Medeco B

Dealers do not need a contract to purchase Medeco B SFIC. Keys and cores are available through Medeco and authorized distributors.

Submitting Orders to Medeco:

For greater efficiency and to create the best ordering experience, orders may be submitted through three order channels: eBusiness, Email or Fax.



eBusiness Order Channel

Benefit: Immediately transmit clean orders to reduce entry time to speed up delivery.

EDI

EDI stands for Electronic Data Interchange. It's the easiest method to use for the transmission of orders. Orders are generated directly from your ERP system and sent directly into Medeco's order entry system. EDI allows for instant and accurate transmission.

Medeco WebShop

Online Order Entry is a convenient web-based form which allows customers to easily use drop-down menus and filtering options to assist with product search and selection. A perfect part number is selected every time!

Visit <http://extranet.assaabloydss.com> to access.

Email Order Channel

Benefit: Immediately submit your orders directly into our Digital Filing System to speed up processing time.

In USA and International (except Canada): orders.medeco@assaabloy.com ; In Canada: orders.medeco.ca@assaabloy.com

Emailing orders in USA and International (except Canada): orders.medeco@assaabloy.com ;

in Canada: orders.medeco.ca@assaabloy.com

This allows customers to submit purchase orders directly into Medeco's Digital Filing System. Once the order is submitted by email, an automatic email notification is sent stating the order has been received by Medeco, thus ensuring the order was not lost in transmission.

Fax Order Channel

Benefit: Immediately submit orders directly into our Digital Filing System to speed up processing time.

Typed submissions receive EDI benefits of faster processing and accuracy.

- **USA Fax: 800.421.6615** • **Canada Fax: 888.263.3326** • **International Fax (except Canada): 540-380-1634**

Faxing orders in USA: 800.421.6615 ; Canada: 888-263-3326 allows customers to submit purchase orders directly into Medeco's Digital Filing System. If a faxed order is typed versus handwritten, Medeco will be able to use an internal tool to send typed, faxed orders through the EDI portal to create faster order processing and reduce entry errors.

Special Pricing (SP) and Quotations

The SP or quote number must be referenced on the order, when submitted for processing. Any invoiced order that has the incorrect discount applied to it and did not have the SP or quote number written on the order will have a service fee of \$100.00 net DEDUCTED from any sales credit issued for the difference in the discount.

Medeco is continually developing online resources to make ordering, system management and training quicker and easier than ever. Ask your Medeco representative for more information or contact:

In USA: Customer Care Department at 877-633-3261, or customerservice.medeco@assaabloy.com.

In Canada: Customer Care Department at 888-633-3264, or customerservice.medeco.ca@assaabloy.com.

Medeco WebShop

The new online order entry site for Medeco products, Medeco WebShop is the quickest method to submit orders directly to the Medeco factory. It makes ordering your favorite Medeco products easier than ever before! Products are searchable by technology and type, with complete descriptions and photos. Save time by creating custom lists of commonly ordered products.

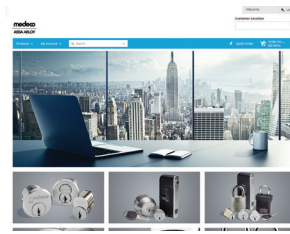
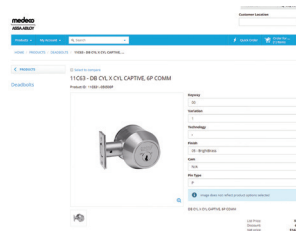
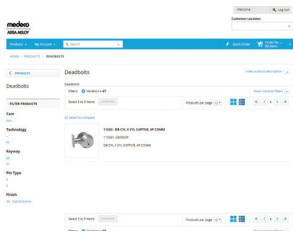

Training Opportunities with Medeco

Medeco offers **in-depth, hands-on training** through comprehensive factory certification programs held throughout the year at our Salem, Virginia, facility and other convenient locations across the United States and Canada.

Our certification courses provide a detailed study of Medeco's patented **Medeco 4 High Security** technology, along with specialized certification programs for our **Medeco X4, CLIQ, and Medeco XT** product lines. Training sessions at our Salem, Virginia, facility also include an exclusive **factory tour**, giving participants a behind-the-scenes look at the precision engineering and craftsmanship that define Medeco products.

To learn more about these training opportunities, visit [Medeco.com/training](https://www.Medeco.com/training).

Additionally, explore a variety of resources, including installation videos, step-by-step instructions, product overviews, sales technique tutorials, and more—designed to support your success, visit [Medeco.com/en/resources/video-library](https://www.Medeco.com/en/resources/video-library).

For further learning, Medeco offers a wealth of online training materials through the **ASSA ABLOY Academy**. Visit [assaabloyacademy.com](https://www.assaabloyacademy.com) to access these resources.

If you don't already have an account, registration is quick, free, and provides access to a library of complimentary online classes.

For questions about training, reach out to Technical Support at TechSupport.Medeco@assaabloy.com.



Equip yourself with the knowledge, hands-on expertise, and insights to succeed!

Start your Medeco training journey today!



Your New Medeco Business Home!

Complete all documents needed for orders and authorizations, and much more.

The digital interaction makes the ordering process much easier and faster, and eliminates the need to mail or email documentation.

Customers are prompted to sign agreements, design their coining dies, build master key systems, and upload their key schedule.

Tools within Fusion allow both dealers and end users to manage order authorizations, carded programs, and build key systems.

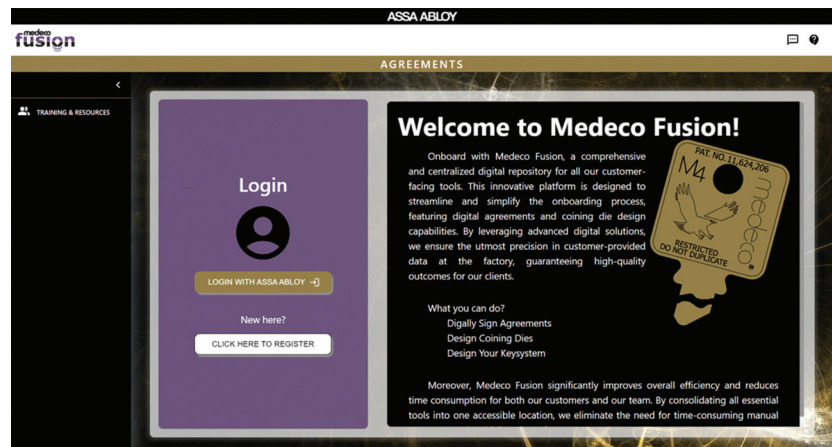

FUSION TOOLS

- Key System Design Studio
- Record of Authorization Portal (ROA)
- Carded Program Portal
- Key Control Program Selector
- Training Resources
- Agreements

HOW FUSION SIMPLIFIES THE PROCESS

- Eliminates need for paper vouchers!
- Contains all documents needed for orders and authorizations
- Fusion combines several portals into one convenient place
- Key system data only needs to be uploaded once
- Coming soon – Fusion Mobile App, Dashboards, Electronic Key Records Delivery, and Retrofit Database.

KEY SYSTEM DESIGN

Build your own key system in Fusion!

Answer a few questions about desired parameters and management capabilities. Fusion also guides you through product ordering and final processing.

It's that easy! For more details, [click here](#).

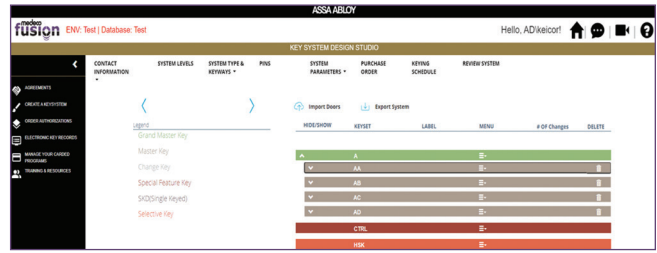

MANAGE CARDED KEY CONTROL PROGRAMS

Medeco's Carded Key Control Programs ensure only authorized individuals can obtain key duplicates.

This process is managed through Fusion by using a USB Mag Stripe Card Reader that plugs into a computer or phone. Manual transactions are also handled in Fusion.

Dealers can also:

- Process transactions to cut keys
- View key blank inventory
- Reorder keyblanks
- See transaction history

[Click here](#) for instructions on how to Manage Carded Programs.

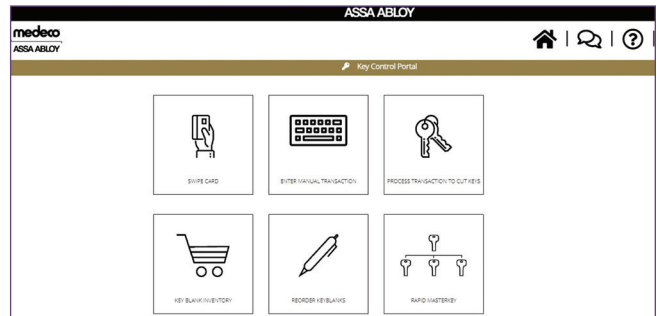

RECORD OF AUTHORIZATION

A Record of Authorization allows an authorized end-user to sign, manage, and authorize ordering of restricted products such as key blanks and pinned cylinders. Users can grant contracted Medeco dealers or distributors permission to order on their behalf.

The Record of Authorization process within Fusion is legally binding and carries the same contractual agreement as a physical letter of authorization.

For more details, [click here](#) to watch a video about managing Records of Authorization.

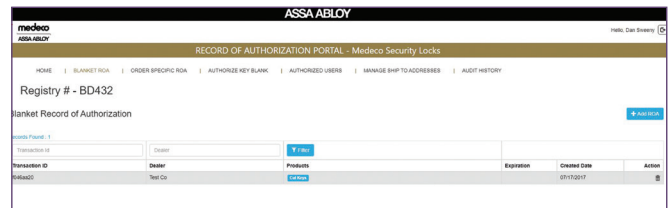

AGREEMENTS

Authorized Dealers and end users enter into a Key Control agreement with Medeco that outlines a strict policy on the distribution and management of keys. These legally defensible contracts mean the highest security possible for customers.

For ease of use and speed, agreements are now managed and signed digitally in Fusion. Customers also design their own coining die in Fusion.

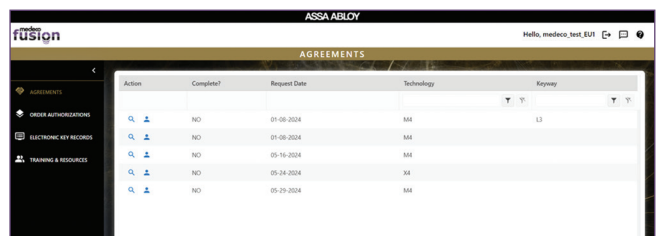

Register for Fusion at fusion.medeco.com



**Provide All of the Needed Information to Avoid Delays!
Use the Medeco Checklist to Submit Clean Orders for Faster Processing**

Medeco Order Checklist for All Orders

- | | |
|--|--|
| <input type="checkbox"/> Account Number | <input type="checkbox"/> Base Part Number |
| <input type="checkbox"/> Purchase Order Number | <input type="checkbox"/> Finish |
| <input type="checkbox"/> Billing Address | <input type="checkbox"/> Keyway |
| <input type="checkbox"/> Shipping Address | <input type="checkbox"/> Cam/Tailpiece |
| <input type="checkbox"/> Shipping Instructions | <input type="checkbox"/> Keying Instructions |
| <input type="checkbox"/> Special Pricing/Quote ID* | <input type="checkbox"/> Quantity |
| <input type="checkbox"/> Special Instructions | |

*The quote number must be referenced on the order.

Any invoiced order that has the incorrect discount applied to it and did not have the quote number written on the order will have a service fee of \$100.00 net DEDUCTED from any sales credit issued for the difference in the discount.

Master Key Checklist

- | | |
|---|--|
| <input type="checkbox"/> New Master Key System: | <input type="checkbox"/> Existing Master Key System |
| <input type="checkbox"/> Master Key System Request Form | <input type="checkbox"/> Registry Number |
| <input type="checkbox"/> Name of End User | <input type="checkbox"/> Name of End User |
| <input type="checkbox"/> Electronic Key Schedule | <input type="checkbox"/> Electronic Key Schedule |
| <input type="checkbox"/> Serialization Instructions | <input type="checkbox"/> Serialization Instructions |
| <input type="checkbox"/> Stamping Instructions | <input type="checkbox"/> Stamping Instructions |
| <input type="checkbox"/> Letters of Authorization | <input type="checkbox"/> Letters of Authorization |

CLIQ™ Checklist

- | | |
|---|---|
| <input type="checkbox"/> New System: | <input type="checkbox"/> Existing System |
| <input type="checkbox"/> End User Name | <input type="checkbox"/> System Number |
| <input type="checkbox"/> End User Email Address | <input type="checkbox"/> End User Name |
| <input type="checkbox"/> Time Zone | |
| <input type="checkbox"/> Choose CLIQ or Classic CLIQ | |
| <input type="checkbox"/> If you chose CLIQ,
select keyway (M3 or X4) | |

Medeco XT Checklist

- | | |
|---|---|
| <input type="checkbox"/> New System: | <input type="checkbox"/> Existing System |
| <input type="checkbox"/> End User Name | <input type="checkbox"/> System Number |
| <input type="checkbox"/> End User Email Address | <input type="checkbox"/> End User Name |
| <input type="checkbox"/> Time Zone | |

Hybrid Checklist

- Site Code
- Serial Number

U.S. Customers – Door Security

Phone: 877-633-3261

Mailing address:

Medeco Security Locks, Inc.

P.O. Box 3075

Salem, VA 24153

Attn: Door Security Customer Service

Fax: 800-421-6615

To submit orders:

orders.medeco@assaabloy.com

To email Customer Service:

customerservice.medeco@assaabloy.com

To email Technical Support:

techsupport.medeco@assaabloy.com



To start a live chat with our technical support or customer support teams, please scan the QR code.

Hours of operation:

Monday – Thursday, 8:00 a.m. – 6:00 p.m. ET

Friday, 8:00 a.m. – 5:00 p.m. ET

Canada Customers

Phone: 905-532-4970

Toll-free (in Canada only) 1-888-633-3264

Mailing address:

Medeco Canada

160 Four Valley Drive

Vaughan, ON L4K 4T9 CANADA

Fax: 905-532-4971 or

1-888-263-3326 (in Canada only)

E-mail: orders.medeco.ca@assaabloy.com

Hours of operation:

Monday – Friday, 8:00 a.m. – 4:30 p.m. ET

**Customers Outside the U.S.
(Not including Canada)**

Phone: +1 540-380-1741

or +1 877-633-3261

Fax: +1 540-380-1634

Mailing address:

Medeco Security Locks, Inc.

P.O. Box 3075

Salem, VA 24153

Attn: International Customer Service

E-mail: exportcs.medeco@assaabloy.com

Submit Orders:

orders.medeco@assaabloy.com

Hours of operation:

Monday – Friday, 8:00 a.m. – 5:00 p.m. ET

Medeco Shipping & Returns Policies

Changes/Cancellations of Orders Policy:**– Order Changes:**

Changes on orders cannot be made after Medeco's acknowledgement is received by Buyer, except on Medeco's written approval and with a quoted price covering cost of making the change, on which a bona fide order must be issued by Buyer authorizing the change and the cost involved. Any change, if authorized by Medeco, will have a 10% change fee in addition to any other costs incurred by Medeco.

– Rescheduling orders and delayed shipments (blanket purchase orders):

Orders will be scheduled based on customer request date and available production capacity. Requests for order rescheduling (either pull-in or delay) may be made by Customer within 7-days (1 week) of initial acknowledgement without a change fee, however acceptance of the change will be entirely at Medeco's discretion. Orders rescheduled or delayed after the 7-day period will be subject to a 10% change fee.

Notification of rescheduling or delay must be in writing via email and can be sent to orders.medeco@assaabloy.com. Medeco order number must be referenced on any change request.

– Order cancellations:

Requests for cancellation must be in writing. Cancellation of orders after order acknowledgement and scheduling shall result in a 10% cancellation fee. Due to the custom nature of Medeco products, if an order or a portion of an order is cancelled and products have already been manufactured and prepped for shipping, a minimum 50% restocking fee **will** apply.

Product Returns (S&R):

Medeco accepts product returns if the product is defective from a manufacturing flaw. Any defects or errors in products reported within the stated warranty or notice period, for which Medeco is responsible, will be promptly rectified.

Returns based upon customer error may be returned at Medeco's option with a minimum 50% restocking fee and only within 90 days of date of invoice. Approval for return of merchandise must be requested from Medeco and, when granted, a return authorization number shall be issued to Buyer.

No return will be accepted unless the shipping container carries the return authorization label. The Returned Goods Authorization (RGA) Number must be visible on the outside of any package returned to Medeco. The RGA form can be found on Medeco.com, the Extranet, or by contacting Customer Service at 877-633-3261 or CustomerService.Medeco@assaabloy.com.

If you need to make a return, fill out an RGA Form and submit as follows:

In USA: Fax: 800-421-6615 or email: orders.medeco@assaabloy.com

In Canada: 888-263-3326 or email to: orders.medeco.ca@assaabloy.com

Outside the USA (except Canada):

The RGA Number must be visible on the outside of any package returned to Medeco. The RGA form can be found on Medeco.com, the Extranet, or by contacting:

Customer Service at 877-633-3261 or

exportcs.medeco@assaabloy.com.

Medeco® Standard and Extended Warranty Mechanical & Intelligent Key Products

Medeco Security Locks Inc. (“Medeco”) warrants to the original purchaser of a Medeco branded lock, lock cylinder, or Intelligent Key hardware product (referred to collectively as “Product”) to be free of defects in material and/or workmanship for a period of two (2) years from the date of original purchase for use. This Warranty may also apply to other specific products. For additional Warranty information or Warranty claim service, contact Medeco Customer Service at (877) 633-3261 or in Canada (888) 633-3264.

An Extended Warranty for Intelligent Key products is available for purchase. Please contact your local Medeco Representative for additional details.

In the event of a defect in material or workmanship during the Warranty period, Medeco will repair or replace (at its option) the Product under the conditions of this Warranty, this action being the sole remedy available to the purchaser under this express limited Warranty.

Limitations, Exclusions and other Rights:

- a. Medeco disclaims liability for implied warranties, including but not limited to those of merchantability or fitness for any particular purpose.
- b. Medeco disclaims liability for indirect, incidental or consequential damage at any time.
- c. Intelligent Key batteries are not covered under this warranty or any extended warranty.
- d. This Warranty gives specific legal rights, and a buyer may also have other rights that may vary from state to state. Some states do not allow limitations on indirect, incidental, and consequential damages or implied warranties so that the above limitations may not fully apply.
- e. Medeco mechanical keyblanks are made from a special nickel silver alloy. Medeco warrants its mechanical keys against defects in workmanship or breakage for the life of the Product. Bitted Medeco keys must be precisely cut to exact angles and depths, and require special duplication. This Warranty shall be void and Medeco disclaims liability of any kind in the event any key other than a genuine Medeco key has been used with the Product or that the key has been cut on any machine other than a Medeco or Medeco-approved key cutting machine.
- f. Medeco CLIQ Intelligent keys are covered for one (1) year against breakage (mechanical blade only).
- g. Medeco Intelligent Keys Cabinets (IKC) are covered under this two (2) year warranty. Within that time frame, Medeco will repair or replace any component that is found to have a defect.
- h. Medeco shall not be held responsible for product complaints or product damage arising from, in its sole judgment, and absence of user training, improper installation, failure to provide normal maintenance, extreme environmental conditions, use rates in excess of the industry standards defined for the type of product, use of incompatible parts or products not made or authorized by Medeco, or application of force not resulting from normal use.
- i. Unless otherwise specified by separate warranty, finishes are warranted for a period of two years following purchase for use. This finish Warranty shall be considered void after installation if, in the sole judgment of Medeco, the damage to the finish is the direct result of extreme climatic conditions, chemical or abrasive actions.

Medeco Standard Terms and Conditions of Sale

Effective January 1, 2025

Special terms may be applied for special circumstances and by mutual agreement.

These Medeco Standard Terms and Conditions of Sale (these “Terms and Conditions”) set forth the entire agreement between “Medeco,” the company named on the face hereof (or the document attached or linked hereto) and the “Buyer,” the person or entity who accepts Medeco’s quotation for the sale of Products or whose order for Products is accepted by Medeco. Unless otherwise agreed in writing by Medeco, these Conditions shall apply to and govern all contracts for the sale and supply of goods (“Products”), between Buyer and Medeco and all orders are accepted in accordance with these Conditions.

1. Prices:

Prices are subject to change without notice. No prices are guaranteed unless accompanied by an official price quotation from Medeco. All quotations are valid for 90 days unless otherwise noted but represent no obligation until Medeco accepts Buyer’s order.

Pricing for orders with requested ship dates greater than 90 days in the future, including blanket orders, may be adjusted by Medeco to Medeco’s prevailing prices at the time of shipment.

Buyer’s possession of Medeco’s price list does not constitute an agreement to sell.

Medeco may, under exceptional circumstances (e.g., supply chain / cost variances) and in its sole and absolute discretion, adjust pricing to match Medeco’s prevailing prices at the time of shipment.

2. Terms:

All sales are NET 30 days unless otherwise agreed in writing. Late accounts shall bear interest at a rate of 1-1/2% per month.

3. Delivery:

Unless otherwise prearranged, Buyers shall be invoiced F.O.B. Shipping Point. Buyer’s freight terms shall be by mutual agreement as negotiated yearly. Freight will be charged according to Medeco’s prevailing freight policy. If Buyer selects a carrier with a higher rate, Buyer will be charged the rate difference. Cartage charges for delivery from freight terminal to Buyer’s warehouse are for Buyer’s account. When delivered to the transportation company, all shipments become the property of the Buyer, who assumes the risk of loss or damage in transit.

4. Acceptance:

Medeco reserves the right to decline an order, in whole or in part, when the type or quantity of Products or credit worthiness

of Buyer is not satisfactory to Medeco in its sole and absolute discretion.

Purchase orders, quote requests, order acknowledgements, or other similar transaction materials issued by the Buyer that have contrary standard terms and conditions are not binding on Medeco, unless such terms and conditions are approved in a separate written agreement by Medeco’s authorized representatives. In the event of an acceptance of the Buyer’s purchase order by Medeco, or Buyer’s acceptance of Medeco’s quote or proposal, the Buyer agrees that such acceptance is solely limited to and conditioned upon the Buyer’s acceptance of these Terms and Conditions, which may not be changed or waived except in a separate writing signed by the parties. In any event, acceptance by Buyer of the Products shall be deemed unqualified acceptance of these Terms and Conditions and no course of action shall be deemed to modify these Terms and Conditions.

5. Invoicing:

Medeco has a minimum order value of \$50 except for service orders for cut keys or replacement cards, for which a minimum charge of \$25.00 net will be applied.

Minimum order charges are not imposed on the following types of orders:

- a) Partial shipments.
- b) Returned Products (must be accompanied by Medeco’s return authorization number).
- c) Search fee for key codes.

6. Returned Goods:

Medeco accepts product returns if the product is defective from a manufacturing flaw. Any defects or errors in Products reported within the stated warranty or notice period, for which Medeco is wholly responsible, will be promptly rectified.

Returns based upon customer error may be returned at Medeco’s option with a minimum 50% restocking fee and only within 90 days of date of invoice.

Approval for return of merchandise must be requested from Medeco and, when granted, a Returned Goods Authorization (RGA) number shall be issued to Buyer. No return will be accepted unless the shipping container carries the return authorization label. The RGA Number must be visible on the outside of any package returned to Medeco.

7. Claims:

In the event of [Buyer or Medeco] error, claims for shortages, pricing errors, and/or incorrectly filled orders must be submitted in writing to Medeco Customer Service within 30 days from receipt of material. Any claims for shortages or damage by the carrier must be made by the buyer directly to the carrier. Limited carrier insurance is typically offered for all orders. If the customer requires or desires additional insurance, please contact a Medeco Customer Service representative upon submittal of the order. Medeco will obtain requested insurance and the additional costs will be included on the customer’s invoice.

8. Invoice Deductions:

A Medeco Credit representative must be notified of any disputed invoices within 60 days from the date of invoice. Deductions should only be taken for the disputed amount and the balance of the invoice is due and payable with standard payment terms.

9. Change in Orders:

Changes on orders cannot be made after Medeco’s acknowledgement is received by Buyer, except on Medeco’s written approval and with a quoted price covering cost of

Continued on the next page.

Medeco Standard Terms and Conditions of Sale *(Continued)*

making the change, on which a bona fide order must be issued by Buyer authorizing the change and the cost involved. Any change, if authorized by Medeco, will have a 10% change fee in addition to any other costs incurred by Medeco.

Orders will be scheduled based on customer request date and available production capacity. Requests for order rescheduling (either pull-in or delay) may be made by Customer within 7-days (1 week) of initial acknowledgement without a change fee, however acceptance of the change will be entirely at Medeco's discretion. Orders rescheduled or delayed after the 7-day period will be subject to a 10% change fee. Notification of rescheduling or delay must be in writing via email and can be sent to orders.medeco@assaabloy.com. Medeco order number must be referenced on any change request.

10. Incomplete Orders:

Orders lacking complete information for order entry will be held for receipt of complete information. Once notified of the information needed, Buyer will have 10 business days to reply with a plan to supply the missing information, or the order may be suspended.

11. Cancellations:

Requests for cancellation must be in writing. Cancellation of orders after order acknowledgement/scheduling shall result in a 10% cancellation fee. Due to the custom nature of our products, if an order or a portion of an order is cancelled and products have already been manufactured and prepped for shipping, a minimum 50% restocking fee will apply.

12. Packing and Cartage:

Unless otherwise stated, prices shall include all charges for Medeco's usual packing and crating and for cartage to F.O.B. point. Medeco shall not be obligated to provide special containers unless specified and agreed to in advance in writing by Medeco.

13. Allocation:

If sufficient Products are not available for any reason, Medeco may allocate Products among its customers. Allocation of Products pursuant to this Section shall completely satisfy and discharge Medeco's supply obligations and Medeco shall,

therefore, not be deemed to be in breach of such obligations.

14. Taxes and Government Regulations:

Any license fee, property, sales, use or excise tax which may be levied, assessed, or imposed by government authority on any of Medeco's Products shall be added to the price therefore and be paid by the Buyer. Any increase in Medeco's costs in purchasing materials or in manufacturing, processing, selling, or delivering its Products resulting from any governmental tax or regulation or industry shall be added to the selling price and be paid by the Buyer.

15. Dies, Patterns, and Special Tools:

Materials, tools, and equipment required to fill any sales contract or order issued by Buyer shall be furnished by Medeco, unless otherwise specified. If any materials, tools and/or equipment are furnished by or on behalf of Buyer for use by Medeco, they shall be of good quality and workmanship and sufficient for the intended purpose. Any such materials, tools or equipment furnished by or on behalf of Buyer to Medeco on other than a charge basis shall be held by Medeco as Buyer's property and Medeco shall account therefore, provided that Buyer shall allow for a reasonable wear or scrap loss on materials.

16. Warranty:

Medeco warrants that all Products will conform with applicable drawings and specifications agreed upon in writing by Medeco, it being understood that reasonable variances not impairing the usefulness thereof shall be allowed, that said Products will be free from material defects in material or workmanship which impair the usefulness thereof within the stated warranty period. If any Product shall fail to conform therewith or be materially defective, Buyer's sole and exclusive remedy against Medeco will be for the repair or replacement of the defective Products, such repair or replacement to be at Medeco's sole discretion. EXCEPT AS PROVIDED

IN THIS SECTION 16, MEDECO HEREBY EXPRESSLY DISCLAIMS ALL WARRANTIES, EXPRESS OR IMPLIED, AT LAW OR IN EQUITY, WITH RESPECT TO THE PRODUCTS

OR THEIR CHARACTERISTICS, QUALITY, PERFORMANCE OR VALUE, INCLUDING, WITHOUT LIMITATION, THE IMPLIED WARRANTIES OF MERCHANTABILITY, FITNESS FOR A PARTICULAR PURPOSE, OR NON-INFRINGEMENT OF ANY INTELLECTUAL PROPERTY RIGHTS OF THIRD PARTIES.

17. Limitation of Liability:

IN NO EVENT SHALL MEDECO BE LIABLE FOR SPECIAL, INDIRECT, INCIDENTAL, OR CONSEQUENTIAL DAMAGES, WHETHER IN CONTRACT, WARRANTY, NEGLIGENCE, TORT, STRICT LIABILITY, OR OTHERWISE. Medeco's liability on all claims, whether in contract, warranty, negligence, tort, strict liability or otherwise for any loss or damage arising out of, or connected with an order or the performance or breach thereof, or from the design, manufacture, sale, or delivery of products shall in no case exceed the lesser of {\$X} and the purchase price of the products Under the applicable order. THE PARTIES AGREE THAT IN NO EVENT SHALL MEDECO BE LIABLE TO BUYER, A USER, OR ANY THIRD PERSON FOR LOSS OR DAMAGES TO PROPERTY RESULTING FROM FAILURE OF MEDECO'S PRODUCT(S) TO OPERATE OR TO FUNCTION PROPERLY, NOR ANY INDIRECT, SPECIAL OR CONSEQUENTIAL DAMAGES RESULTING THEREFROM. BUYER SHALL OBTAIN ITS OWN INSURANCE COVERING PERSONAL INJURY AND PROPERTY LOSS OR DAMAGE TO ITS PREMISES, AND HEREBY AGREES TO INDEMNIFY MEDECO AGAINST ALL CLAIMS OF THIS NATURE.

18. Delays:

Medeco shall not be liable for any loss or damage caused by delays or defaults in performance hereunder due to any cause that is beyond Medeco's control, including but not limited to strikes, lockout or trade disputes (whether involving its own employees or those of any other person), breakdown of machinery, riots, fires, accidents, governmental interference or embargoes, shortages of materials, fuel, labor, supplies or transportation, or due to any cause of a like or different nature beyond its control. The existence of any such cause of delay shall extend the time of performance or delivery of any order or any uncompleted portion thereof by the time or times required removing any such excusable cause or causes of delay.

Continued on the next page.

Medeco Standard Terms and Conditions of Sale *(Continued)*

Additionally, should any such event occur, Medeco may cancel, reschedule, or suspend any order of Products made by Buyer without incurring liability to Buyer for any loss or damage.

19. Modifications:

Unless otherwise agreed to in writing by Medeco, the Terms and Conditions in effect at the time of order acceptance shall constitute the entire contract between the parties hereto and no agreement or other understanding in any way modifying, affecting, or canceling same will be binding unless made in writing, signed by an officer of Medeco and a duly authorized representative of Buyer. Stenographic and clerical errors or omissions are subject to corrections. Buyer shall reference the current version of Medeco's Terms and Conditions as referenced on its website at the time of transaction, as Medeco may make modifications from time to time without specific notice to Buyers. These Terms and Conditions shall apply to all future spot sales from Medeco to Buyer unless a written contract therefore has been entered into by the parties.

20. Compliance with Law:

Each party agrees to comply with all other state, Federal, and local laws applicable to its performance hereunder.

21. Financial Responsibility:

All shipments shall at all times be subject to the approval of Medeco's Credit Dept. In the event of any proceedings by or against Buyer in bankruptcy or insolvency, voluntary or involuntary, or under Chapters X or XI of the Bankruptcy Act of the United States or for the appointment of a receiver or trustee or an assignee for the benefit of creditors of the property of Buyer, or if Medeco shall deem Buyer's financial responsibility in doubt, or if Buyer fails to make any payment in accordance with the terms of the contract. Medeco may, at its election, stop production under the contract, defer shipment or decline to ship, stop any goods in transit, or Medeco may terminate the contract, all without liability and without prejudice to Medeco's rights for any sums owing to Medeco.

22. No Assignment:

These Terms and Conditions are not assignable or transferable by Buyer, in

whole or in part, without the prior written consent of Medeco.

23. Waiver:

Any waiver of strict compliance with these Terms and Conditions shall not be a waiver of the right to insist upon strict compliance with the terms hereof thereafter.

24. Export Control and Sanctions:

The Customer represents and warrants to Medeco that it will always act in compliance with Economic Sanctions and Export Control Laws, and that:

- a) neither the Customer, its affiliates, or any of their respective directors, officers, employees nor, so far as the Customer is aware, any agents or other persons acting on behalf of any of the foregoing:
 - 1) is, or has been, a Listed Person;
 - 2) has engaged in any business dealings or activities that would reasonably be expected to result in it becoming a Listed Person;
 - 3) directly or indirectly, has conducted or is conducting any business dealings or activities with or for the benefit of, or is otherwise involved in any business with a Listed Person, or otherwise acting in violation of Economic Sanctions and Export Control Laws;
 - 4) has engaged or is engaging in any transaction that circumvents, evades or avoids, or has the purpose or effect of circumvention, evading or avoiding, or attempts to violate, any Economic Sanctions and Export Control Laws; or
 - 5) is, or has been, in violation of, or subject to, any investigation or enquiry by, or on behalf of, any governmental or other regulatory body relating to Economic Sanctions and Export Control Laws.
- b) the Customer shall act in compliance with Economic Sanctions and Export Control Laws, and shall not sell nor re-export the Product without all requisite licenses and approvals under Economic Sanctions and Export Control Laws;
- c) the Customer shall not sell, export or re-export, the Product, directly or indirectly, to the Russian Federation or Belarus or for use in the Russian Federation or Belarus (whether or not permitted under Economic Sanctions and Export Control Laws applicable to the Customer);
- d) the Customer shall undertake its best efforts to ensure that the purpose of this Clause is not frustrated by any third parties further down the commercial chain, including by possible resellers;
- e) the Customer agrees to (i) cascade the contractual obligations set forth in this Clause. in contracts with third parties, including possible resellers, further down the commercial chain.; and (ii) set up and maintain an adequate monitoring mechanism to detect conduct by any third parties further down the commercial chain, including by possible resellers, that would frustrate the purpose of this Clause;
- f) the representations and warranties set forth in this Clause shall always remain true and correct;
- g) the Customer will provide written notice to Medeco as promptly as possible and in any event within five business days, if (i) any representation or warranty should cease to be true at any time., or (ii) the Customer should encounter any problems in applying Clauses b)- e), above, including any relevant activities by third parties that could frustrate the purpose of said clause; and
- h) the Customer will not engage in any transaction for Military End-Use unless explicitly approved by Medeco.
- i) The Customer will provide all information relating to requests for Products, that the Customer suspects could violate or circumvent Economic Sanctions and Export Control Laws, including requests from or on behalf of a Listed Person, and other attempts to acquire Medeco products in violation of Economic Sanctions and Export Control Laws. The Customer will, to the best of its abilities, cooperate

Continued on the next page.

Medeco Standard Terms and Conditions of Sale (Continued)

with Medeco to facilitate compliance with Economic Sanctions and Export Control Laws and will upon Medeco's request provide Medeco with true, complete and correct copies of all documentation relating to any business dealings involving the Product, including but not limited to, end-user certifications, information concerning compliance with the obligations under Clause. b)- e), and other information as may be required by Medeco within two weeks of the simple request of such information.

Medeco shall not be obliged to make any payment or take any other action if Medeco believes in good faith that such action may constitute a violation, contribute to a violation, or constitute a circumvention of any Economic Sanctions and Export Control Laws.

25. Compliance with Anti-Trust, Anti-Corruption and Data Privacy Laws:

The Customer, its directors, officers, and employees shall perform their obligations

under these Terms and Conditions in full compliance with the ASSA ABLOY Code of Conduct which is accessible online at:

[CoC Business partner 2019 English.pdf](#)

26. Governing Law:

These Terms and Conditions and all orders hereunder shall be interpreted, construed and governed by the laws of the Commonwealth of Virginia, without regard to its principles of conflicts of laws, and all actions shall be brought in the appropriate state or federal courts located in the Commonwealth of Virginia.

27. Trademarks:

Buyer shall not use the trademarks of Medeco without Medeco's prior written approval. No license or right to use Medeco's trademarks is implied or granted. Buyer shall defend, indemnify and hold Medeco harmless from and against any expense, judgment, liability or loss including reasonable attorneys' fees, resulting from any claim of infringement of any patents, trademarks or other third

party property rights which result from Medeco's compliance with Buyer's specifications or instructions.

28. No Third Party Beneficiaries:

These Terms and Conditions are for the sole benefit of the parties hereto and their successors and permitted assigns, and nothing herein expressed or implied shall give or be construed to give to any person other than the parties hereto and such successors and permitted assigns, any legal or equitable rights hereunder.

29. Relationship of Parties:

Nothing contained herein shall be construed to create an association, joint venture, trust, or partnership, or impose a trust or partnership covenant, obligation, or liability on or with regard to the parties. Each party shall be individually responsible for its own covenants, obligations, and liabilities under these Terms and Conditions.

Medeco® Construction Core Policy

Here are the details for the new construction core policy:

- Available in Medeco 32 and 33 series cylinders
- All orders must include operating and control key quantities or order may be delayed
- \$50 list per key
- Keys are ordered separately
- Cylinder face color = orange
- 75% credit on original price for returned keys and cores – if returned in first 12 months
- 50% credit if returned in 13-36 months
- No returns after 36 months

Part Numbers:

LFIC Construction Core: 320201CC RY R1. \$209.22

SFIC Construction Core: 33600006 RY CC K. \$101.47

Note: Cut Keys for above construction cores are not included in the price
To learn more about the new Medeco construction core policy, please reach out to Dan Freeman at dan.freeman@assaabloy.com.



Medeco®

Professional Services

To achieve optimum performance of your new key system, Medeco recommends professional design and implementation services. Services include system planning, system deployment, team training and ongoing support.

Medeco Professional Services: Making the most out of your investment



Over our 55 year history, Medeco has established a reputation for developing high-quality products that provide unparalleled security. Yet, high-quality products alone do not guarantee a successful deployment. To achieve optimum performance of your new intelligent Key System, Medeco recommends professional design and implementation services.

Medeco Professional Services includes a variety of offerings that will help you gain additional value from your technology investment. Professional Services include:

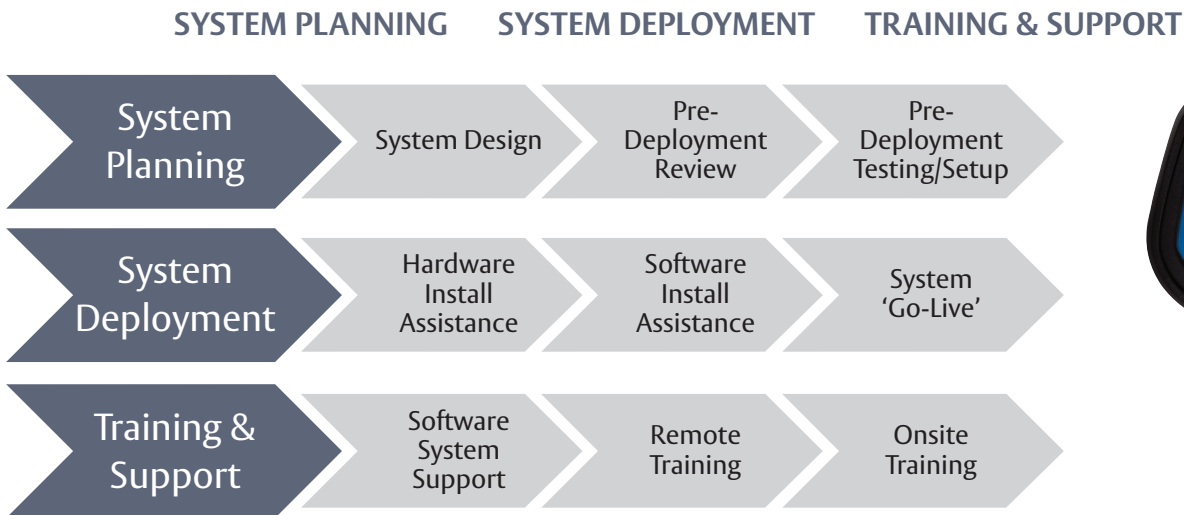

Professional Services

System Planning Services



Medeco Professional Services provides consulting expertise that utilizes industry best practices to strategically plan, scope, and facilitate the design of Medeco solutions tailored to meet your organization's compliance, security, and risk management requirements. Our consulting service packages are meticulously crafted for execution under the guidance of a dedicated project manager.

All prices shown are U.S. LIST and subject to dealer software buying program discount.

Remote Planning Support SW-501Remote **\$926.00/hr 1 hour minimum**

- **System Design Assistance** – Ensure that your system is designed with your current and future interests in mind.

Onsite Planning Support SW-501Site **\$7,021.00/day plus T&E**

- **Pre-Deployment Meetings** – Live in person coordination of events and timeline planning.

System Deployment Services



The Medeco Professional Services team has committed technical consultants and software engineers who collaborate closely with your in-house team to facilitate the deployment and integration of Medeco solutions and third-party systems. This proficient group of systems engineers, integrators, and project management experts will manage and supervise the entire implementation process of your new Intelligent Key System, ensuring that all technical complexities and potential risks are identified in advance. This approach guarantees that your system is purposefully designed to scale according to your current and future needs.

Remote Deployment Services SW-502Remote **\$926.00/hr 1 hour minimum**

- **Remote Software Installation** – Live online assistance with software installation to ensure complete functionality.
- **Remote Software Upgrades** – Using our remote access software we will ensure that your software upgrades go without issue, including data conversions.

Onsite Deployment Services SW-502Site **\$7,021.00/day plus T&E**

- **Equipment Configuration** – The assistance you need to get all of your equipment programmed and installed in a timely manner.
- **Software Installation / Upgrades** – Live assistance from Technical Services to help with the software installation, patching, upgrades, migrations, etc.

Training & Support Services

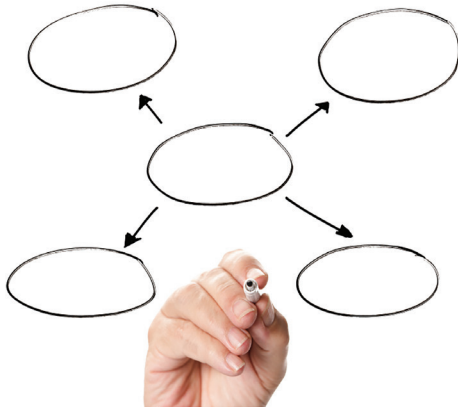

Before implementing your new system, we strongly recommend enrolling your business security team in Medeco technical training. We offer a range of tailored hands-on courses to instruct your team on the proper operation, customization, and support of your new Intelligent Key System.

Our experts will collaborate closely with your team, providing them with the essential knowledge to ensure a smooth start, allowing your new system to operate at peak performance from Day One. In the event of any issues, our team is ready to deliver prompt, professional, and cost-effective assistance via phone, email, or online channels.

For long-term engagements, the Medeco Professional Services team can provide on-site support, ensuring your system's sustained optimal performance on a day-to-day basis. Through continuous expert consultancy, Medeco consultants can streamline troubleshooting processes and assist in defining risk mitigation strategies during upgrades of Medeco solutions. This approach not only enhances system efficiency but also helps reduce training costs for your staff.

Enterprise System Support	SW-504Platinum	Call for Quote
<ul style="list-style-type: none"> • Enterprise System Support – Platinum 	<ul style="list-style-type: none"> – Software System Remote Support for Emergency/Severity. – Extended phone support: available 24 hours a day, 7 days a week (in English). 	
Remote Training	SW-503Remote	\$926.00/hr 1 hour minimum
<ul style="list-style-type: none"> • Web Based Training • Additional Training Based on New Staff/Turnover 	<ul style="list-style-type: none"> – Online training setup to meet your planning schedule. – Online training to help you keep up with new staff requirements. 	
Onsite Training	SW-503Site	\$7,021.00/day plus T&E
<ul style="list-style-type: none"> • Hands-on Training 	<ul style="list-style-type: none"> – In depth face to face training for our hardware and software applications. 	

All prices are U.S. LIST, and subject to dealer software discounting. T&E charges will be quoted upon request.

The Medeco Professional Services team will collaborate closely with your in-house team to support the planning and design, deployment, integration, and ongoing support and training of your new system. Our joint efforts will guarantee that your Medeco Intelligent Key System is operational from Day One and performing at its peak efficiency.

Professional Services

Training Certification Classes	SW-505Site	\$7,021.00/day plus T&E
---------------------------------------	-------------------	------------------------------------

Personalized on-site factory technical certification class(es).

Medeco will provide on-site training sessions, featuring hands-on demonstrations with sample equipment, and certification for students in service, maintenance, and support. These certification classes mirror those conducted at the factory and trade shows. Our training offerings encompass a range of classes, such as Medeco 4, Medeco X4, Medeco XT, CLIQ, and Medeco Master Keying. Refer to our training catalog for comprehensive details on available courses.

Master Key Consultation	SW-506Site	\$7,021.00/day plus T&E
--------------------------------	-------------------	------------------------------------

Master key system design consultation with a Medeco key system design expert.

Engage in a personalized key system design consultation with our expert system designer. We will guide you through the development of a master key system crafted to align with your specific design specifications. The resulting system will be uniquely tailored to your facility, producing custom Key System Schematics, biting lists, and pinning charts.

Key Management Consultation	SW-507Site	\$7,021.00/day plus T&E
------------------------------------	-------------------	------------------------------------

Assistance in the design, implementation, customization, and best practices for sound key control.

Guidance in designing, implementing, customizing, and applying best practices for robust key control products and key management policies. These measures are aimed at minimizing liabilities and prolonging the lifespan of key systems. By incorporating these sound key management practices, your investment in a key system will be optimized.

Professional Services Warranty

Professional Services Warranty. Deliverables Warranty. Medeco represents and warrants that: (a) the Professional Services will be performed in a professional and workmanlike manner with a degree of care, skill and competence that is consistent with generally accepted industry standards reasonably expected of similar types of engagements; and (b) free from defects in workmanship if applicable; and (c) the Deliverables will substantially conform to the description and specifications set forth in the Medeco published catalog, price book, or written quotation, for **a period of thirty (30) days** after the date of delivery (“Warranty Period”), provided Medeco receives written notification of the non-conformity during the applicable Warranty Period. To the extent any Professional Services or Deliverables do not, in Medeco’s sole determination, substantially conform to the foregoing warranties Medeco shall promptly re-perform the Professional Services and/or re-submit the Deliverables. If, after receiving notice of non-conformity, Medeco determines that the Professional Services cannot be performed or the Deliverables cannot reasonably be delivered, pursuant to an accepted purchase order or written quotation, 100% due to Medeco’s sole fault, Medeco may elect to promptly refund the fees paid (less accrued expenses) or waive the fees owed, with respect to such Professional Services or Deliverable, as Customer’s sole and exclusive remedy. This warranty will apply only if: (a) the Deliverable(s) have been properly incorporated, installed, or utilized by or on behalf of Customer at all times and in accordance with all instructions or documentation; and (b) no modification, alteration or addition has been made to the Deliverable(s) other than with Medeco’s written consent; and (c) Medeco receives written notification of and approves of the warranty claim during the applicable Warranty Period.

THE EXPRESS WARRANTIES FOR PROFESSIONAL SERVICES SPECIFIED HEREIN ARE EXCLUSIVE AND TAKE THE PLACE OF AND SUPERSEDE ALL OTHER WARRANTIES, WHETHER EXPRESS OR IMPLIED, INCLUDING WARRANTIES OF MERCHANTABILITY OR FITNESS FOR A PARTICULAR PURPOSE.

Intelligent Technology Overview

Medeco Retrofit Capabilities Merged with Operational Intelligence

Medeco CLIQ



Great for applications that need auditing/schedule with mechanical features

- Powerful software allows users to audit all activities, including authorized and unauthorized attempts
- Limit the impact a lost key has on a system, keys can be disabled
- Robust scheduling, easily control who can access an opening and when a user is permitted to access an opening
- Cost control, no hardware change necessary for rekeying, rekeying handled through software platform



LARGE
System Size



XT



Security, regulatory compliance, and accountability on every opening

- Available in all formats, including SFIC
- Rechargeable key stores thousands of audit trail events
- Place each key on a unique schedule based upon access requirements
- Act immediately without rekeying with personnel changes or lost/stolen key
- Attack resistant design and tamper-proof features help make opening more secure

LARGE
System Size



Medeco M³ & X4 CLIQ[®]

Medeco M³ and X4 CLIQ merge the features of electronics with reliable mechanical technology – all in a retrofit cylinder. M³ and X4 CLIQ offer end users audit trail, user access schedules and the ability to quickly and remotely change Intelligent Key authorizations with the CLIQ Web Remote or CLIQ Connect App.

M³ and X4 CLIQ installs with no wiring in a matter of minutes. Intelligent Keys and digital cylinders reprogram wirelessly for electronic master keying. CLIQ can be combined with systems featuring Medeco³, X4 or BiLevel mechanical products to offer a blended security solution.

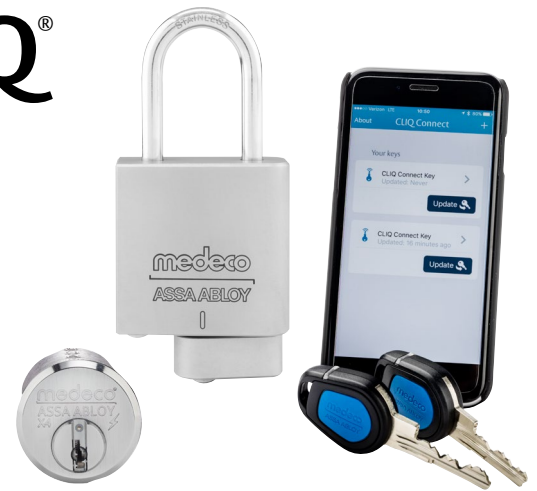

Audit Accountability

Audit information recorded in both the lock and key shows a time-and-date stamped record of every event, including authorized accesses and unauthorized attempts.



Uses Existing Hardware

The CLIQ Intelligent Key provides all power to the cylinder, eliminating the need for any hard wiring or power supply. Simply remove the existing mechanical cylinder and install the M³ or X4 CLIQ cylinder. CLIQ can be keyed in with Medeco mechanical systems featuring Medeco 3 or X4 (not available in SFIC).



Reduces Risk of Lost Keys

Respond quickly to security threats, lost or stolen keys, or personnel changes utilizing expiring Intelligent Key validation intervals and remote programming.



Electronic Scheduling

Intelligent Keys are programmed for specific openings with fully flexible scheduling. Access profiles can be created where programming updates are generated automatically when an opening is added or removed.

Technical Information:

- **Audits:** Key capacity – 1,000 events
Cylinder capacity – 750 events
- **Management:** CLIQ Web Manager with Medeco Hosted or Self-Hosted License
- **Power:** Power supplied by the key, no hard wiring required
- **Weather Resistant:** Can be used in indoor or outdoor applications.
– Rated for -20°F to 122° F (cylinder)
- **Security:** Encrypted identification in cylinder and Intelligent Key
- **Formats:** Available in all common cylinder formats including KIK/KIL, LFIC, padlocks and deadbolts

Key Features:

- Mechanical and electronic technology are combined for superior security with Medeco patented key control
- Audit key that stores up to 1,000 audit records provides information unavailable in a mechanical system
- Powered by an easily replaceable coin cell battery with 20,000 cycle battery life
- Available with RFID/PROX coil insert for dual use with HID compatible systems
- Visible and audible status feedback
- Compact size in water resistant housing
- Bluetooth enabled option with iOS and Android App support.

Warranty:

Medeco[®] warrants the M³ & X4 CLIQ products to be free of defects in material and/or workmanship for a period of two (2) years from date of original purchase

Finishes:

- Available in several finish options

eCLIQ now available!

eCLIQ is Medeco's newest addition to the CLIQ family, and provides electronic access control without wiring.

- Water-resistant key with lifetime battery
- Universal keyway – no cutting keys, or re-keying
- Uses same software as CLIQ



Visit [Medeco.com/eCLIQ](https://www.Medeco.com/eCLIQ) for more details!

Example of a CLIQ configured part number

Base Part # Example	Cylinder Variation	Technology	Finish	Keyway	Pinning	Cam or Tailpiece*
10 0200	<i>If none required, leave blank</i>	S	26	LT	P	Z01
Q = ATEX R = Delay S = Sequence U = Online		M = X4 S = M ³ V = Biaxial Z = Original				

- **ATEX** (intrinsically safe certification) ATEX certified hardware reduces the risk of ignition and explosion in areas with possible exposure to flammable gases or vapors, or combustible dusts. Ideal for use in areas where ignition or explosion is a concern.
- **Sequence** (Dual Custody) – When enabled, requires two keys to open. Keys must have different IDs and be inserted in within one minute of each other.
- **Delay lock** – When enabled, a specified time is communicated to the key before opening. The time will be added to the keys activation and expiration time when checking the validity of the key and its LOAL entries, creating a time-delay sequence for opening within a specific schedule.
- **Online Open** – When enabled, the access decision for a CLIQ Connect key is done during opening, providing real-time access management and audit trail. The key is automatically updated when inserted into the cylinder, and will only open the cylinder if allowed once the update has finished. The sequence takes 5-10 seconds.

Upcharge applies to special features: ATEX + \$50 List cylinders, + \$20 List for keys. Online Open, Sequence Lock, Delay Lock: + \$50 List Price for cylinders. Only one feature is available per cylinder at a time. Must be indicated at the time of order.

Rim and Mortise Cylinders

A simple replacement of rim or mortise cylinders with M³ or X4 CLIQ provides audit and scheduling along with expiration of credentials for any existing opening utilizing mortise hardware. Cylinders are available in all popular lengths and in any existing mechanical keyway. They are an ideal upgrade for offices requiring loss and liability control or as override for traditional EAC equipment.



Medeco M³ & X4 CLIQ Mortise Cylinders

Priced as Pinned. Master Key Up-charge of \$47.50 applies.

Description	Part Number	Price	M ³	X4
1 1/8" Mortise Cylinder	100200	\$878.09	•	•
1 1/4" Mortise Cylinder	100500	\$880.73	•	•
1 3/8" Mortise Cylinder	105100	\$878.32	•	
1 1/2" Mortise Cylinder	105200	\$920.78	•	
1 3/4" Mortise Cylinder	105400	\$1,004.61	•	•
2" Mortise Cylinder	105500	\$1,033.69	•	

Medeco M³ & X4 CLIQ Rim Cylinders

Description	Part Number	Price	M ³	X4
Rim Cylinder, Horizontal Tailpiece	100400H	\$878.98	•	•
Rim Cylinder, Vertical Tailpiece	100400V	\$878.98	•	•
Rim Cylinder, Lazy Motion	100700	\$878.98	•	
Rim Cylinder, Sargent Mounting Style, Horizontal Tailpiece	100403H	\$878.98	•	
Rim Cylinder, Sargent Mounting Style, Vertical Tailpiece	100403V	\$878.98	•	

* Must specify cam (mortise) or tailpiece (rim) when ordering. See pages 83-84 for cam and tailpiece part numbers and descriptions. If not specified, Z01 cam will be supplied for mortise, Y02 tailpiece will be supplied with rim cylinders.

Key-In-Knob/Lever Cylinders

M³ & X4 CLIQ merges the flexibility of electronics with reliable mechanical technology – all in a key in knob or key in lever retrofit cylinder. Offers user audit trail, user access schedules and the ability to quickly add or remove a key electronically from a system, allowing quick response to security threats or lost/stolen keys. These cylinders fit nearly all popular brands and styles of hardware and are therefore an ideal application for offices, storage and file rooms, as well as any door where cylindrical hardware is used.



Medeco M³ & X4 CLIQ Cylinders for Arrow

Description	Part Number	Price	M ³	X4
Cylinder Package for Arrow RK & MK Series Knobs & GL Series levers. Includes CT-Y70, CTY73, & CP-160321. Original cylinder spacer must be replaced with Medeco cylinder spacer CP-160321	20200A1	\$909.35	•	•
6 Pin cylinder for Arrow D & E single cylinder deadbolts; and Revolution V2 Deadbolts. *Order CT-Y27 tailpiece separately.	200901	\$908.04	•	
6 Pin cylinder for Arrow D & E double cylinder deadbolts	200902	\$908.04	•	

Medeco M³ & X4 CLIQ Cylinders for Alarm Lock*Priced as Pinned. Master Key Up-charge of \$47.50 applies.*

Description	Part Number	Price	M ³	X4
Cylinder for Alarm Lock Trilogy T1, T2, T3	20200V1	\$907.04	•	•

Medeco M³ & X4 CLIQ Cylinders for Cal-Royal

Description	Part Number	Price	M ³	X4
Cylinder for Cal-Royal SL00 knob lock and LX01 lever lock	2020049	\$907.04	•	•
Cylinder for Cal-Royal CLS03 Classroom function Grade 2 lever lock	20200V1	\$907.04	•	•

Medeco M³ & X4 CLIQ Cylinders for Corbin Russwin

Description	Part Number	Price	M ³	X4
Cylinder for Corbin Russwin CL3900	20200V9	\$907.04	•	
Cylinder for Corbin Russwin CL3300, CL3400, CL3500, & CL3600	2021173	\$907.04	•	•
Jumbo Mortise Cylinder for Corbin Russwin	101350	\$902.87		•

Medeco M³ & X4 CLIQ Cylinders for Dorma

Description	Part Number	Price	M ³	X4
Cylinder for Dorma CL853, CL860 (exterior), CL880, CL882, CL80EL, CL80EU Grade 1 lever, CK853, CK860 (exterior), CK880, CK882, CK80EL, & CK80EU Grade 1 knobs	20200V1	\$907.04	•	•
Cylinder for Dorma CL860 (interior), CL870, CL872, CL873, CL877 Grade 1 Lever, CK860 (interior), CK870, CK872, CK873 & CK 877 Grade 1 Knobs	20200V0	\$907.04	•	•
Cylinder for Dorma CL700 Series	2020049	\$907.04	•	•

Medeco M³ & X4 CLIQ Cylinders for Embassy

Description	Part Number	Price	M ³	X4
Cylinder for Embassy in Entrance, Institution, Storeroom, Corridor Functions. For Embassy Levers sold thru 9/06 and ALL Knobs	20200V1	\$907.04	•	•
Cylinder for Embassy Vestibule, Communicating, Classroom & Classroom Security Functions. For Embassy Levers sold thru 9/06 & ALL Knobs	20200V0	\$907.04	•	•

Medeco M³ & X4 CLIQ Cylinders for Falcon

Description	Part Number	Price	M ³	X4
Cylinder for Falcon B Series	2020049	\$907.04	•	•
Cylinder for Falcon B (CT-Y49), LY (CT-Y72), X (CT-Y68, except H knob or CT-Y71 - H knob), S (CT-Y54 - except H knob, or CT-Y58 - H knob) & F521, F561, F581, and N Series Knobs (CT-Y49 horizontal)	20200F1	\$909.35	•	•
Cylinder for Falcon Inside Cylinder T-381	2020073	\$907.04	•	•
Cylinder for Falcon T & RU Series, T381 Outside Cylinder	20200V3	\$907.04		•

Medeco M³ & X4 CLIQ Cylinders for KABA Mas Hamilton

Description	Part Number	Price	M ³	X4
Cylinder for Kaba E-plex 5000	2020000	\$907.04	•	•
Cylinder for Mas-Hamilton Power Lever	20200V1	\$907.04	•	•

Medeco M³ & X4 CLIQ Cylinders for LSDA

Description	Part Number	Price	M ³	X4
LSDA Cylinder package fits 100, , L100, LH1000, LX1000 Series. Includes: CT-Y49, CT-Y70, CTY73, CT-Y78	20200L1	\$909.35	•	•

Cylinder Technologies are represented by the following letters:
 S = M³ CLIQ, M = X4 CLIQ, V = Medeco Biaxial CLIQ, Z = Medeco Original CLIQ

Medeco M³ & X4 CLIQ Cylinders for Marks

Priced as Pinned. Master Key Up-charge of \$47.50 applies.

Description	Part Number	Price	M ³	X4
Cylinder for Marks 110, 170, 180, 190, 195, 295 Series DA-Vestibule, DC & SB Communicating, S-Classroom & Classroom Security functions	20200V0	\$907.04	•	•
Cylinder for Marks Lever 110, 170, 180, 190, 195 & 295 Series in AB-Entrance, DWInstitution, F-Storeroom, & T-Corridor Functions	20200V1	\$907.04	•	•

Medeco M³ & X4 CLIQ Cylinder for Olympus

Description	Part Number	Price	M ³	X4
Cylinder for Olympus 700LCM & 800 LCM Key Retaining	20200S1	\$909.35	•	•
6 Pin Cylinder for Olympus 700LCM & 800LCM Non-Key retaining	20009S4	\$913.09	•	•

Medeco M³ & X4 CLIQ Cylinders for PDQ

Description	Part Number	Price	M ³	X4
Cylinder for PDQ Lever SP & ST Series, GT, XGT, & GP Series	20200V2	\$907.04	•	

Medeco M³ & X4 CLIQ Cylinder for SARGENT

Description	Part Number	Price	M ³	X4
Cylinder for SARGENT 6, 7, 10, and 10X Line KIK Series	2080147	\$908.04	•	•
Cylinder for SARGENT 11 Line KIK Series	2080148	\$908.04	•	
Cylinder for SARGENT 6 Line (B knob only)	2020173	\$907.04		•
Cylinder for SARGENT 10X Series	2080161	\$906.04	•	•

Medeco M³ & X4 CLIQ Cylinders for Schlage

Description	Part Number	Price	M ³	X4
Cylinder Package for Schlage A, AL, C, D, ND & Olympiad lever designs, includes: CT-Y49 (A, AL, & D Olympiad Lever & C & D Plymouth), CT-Y52 (C & D heavy duty knobs Ball, Globe & Sphere designs only), CT-Y53 (A series Orbit), CT-Y73 (ND series Gr. 1 lever & AL thick doors), and CTY74 (45-101 padlock)	20200S1	\$909.35	•	•
Cylinder for Schlage S Series Lever	2020097	\$909.35	•	•
Cylinder for Schlage B, E & F160 Series	20009S4	\$913.09	•	•

Medeco M³ & X4 CLIQ Cylinders for Yale

Description	Part Number	Price	M ³	X4
6 pin cylinder for Yale 5300LN, 5400LN and 4300 Series	200503	\$907.04	•	•

Medeco M³ & X4 CLIQ Cylinders for TACO

Description	Part Number	Price	M ³	X4
Cylinder for TACO LXV Lever Lockset	2020078	\$907.04	•	

Interchangeable Core Cylinders

Medeco Large Format Interchangeable Core (LFIC) cylinders are designed so that cores can quickly and easily be changed by non-technical personnel using a special control key. Locks can, in effect, be "rekeyed" without having a working knowledge of the lock or having to take the lock apart. Medeco M³ & X4 CLIQ format additionally provides the benefits of audit and scheduling features. LFIC cylinders fit many of the industry standard formats making them appropriate for almost any door/hardware application.

**Medeco M³ & X4 CLIQ LFIC Cylinders**

Description	Part Number	Price	M ³	X4
Cylinder for Medeco 6 pin LFIC	320201	\$897.27	•	
Cylinder for Yale 6 pin LFIC	310100	\$897.27	•	•
Cylinder for Yale 7 pin LFIC	310100A	\$897.27	•	•
Cylinder for Schlage LFIC	322201	\$905.27		•

Cylinder Technologies are represented by the following letters:
S = M³ CLIQ, M = X4 CLIQ, V = Medeco Biaxial CLIQ, Z = Medeco Original CLIQ

Deadbolts

In addition to the physical security of the Maxum deadbolt, the M³ and X4 CLIQ cylinder provides an audit trail, the ability to schedule user access rights and the freedom to quickly add or remove a key from the system. The M³ and X4 CLIQ deadbolt installs with no wiring in a matter of minutes and is available in existing mechanical keyways. Attack-resistant design and tamper-proof features provide strong protection against forced entry and allow for flawless integration into any home or business application.



Note: All Medeco M³ and X4 CLIQ Double Cylinder Deadbolts use Mechanical Cylinders on the inside of the deadbolt.

Medeco M³ & X4 CLIQ Deadbolt Cylinders

Priced as Pinned. Master Key Up-charge of \$47.50 applies.

Description	Part Number	Price	M ³	X4
Cylinder for Arrow D, E & DB Series Single Cylinder Deadbolts	200901	\$908.04	•	
Cylinder for Sargent 470 & 480 single cylinder deadbolt	200901	\$908.04	•	
Cylinder for Sargent 470 & 480 double cylinder deadbolt	200902	\$908.04	•	
Lazy Motion Cylinder for Schlage B series (old style) deadbolt	200904	\$908.04	•	

Medeco M³ & X4 CLIQ Maxum Deadbolts – Commercial Trim

Description	Part Number	Price	M ³	X4
• Single Cylinder Maxum Deadbolt, 1-1/8" Faceplate, 2-3/8" Backset	11C601	\$1,036.84	•	•
• Single Cylinder Maxum Deadbolt, 1-1/8" Faceplate, 2-3/4" Backset	11C602	\$1,036.84	•	
• Single Cylinder Maxum Deadbolt, 1" Faceplate, 2-3/8" Backset	11C603	\$1,036.84	•	
• Single Cylinder Maxum Deadbolt, 1" Faceplate, 2-3/4" Backset	11C604	\$1,036.84	•	
• Single Cylinder Maxum Deadbolt, Drive In Front, 2-3/8" Backset	11C605	\$1,036.84	•	
• Single Cylinder Maxum, Drive In Front, 2-3/4" Backset	11C606	\$1,036.84	•	
• Single Cylinder Maxum Deadbolt, Less Bolt	11C60L	\$952.29	•	•
Double Cylinder Maxum Deadbolt, 1-1/8" Faceplate, 2-3/8" Backset	11C621	\$1,147.34	•	
Double Cylinder Maxum Deadbolt, 1-1/8" Faceplate, 2-3/4" Backset	11C622	\$1,147.34	•	
Double Cylinder Maxum Deadbolt, 1" Faceplate, 2-3/8" Backset	11C623	\$1,147.34	•	
Double Cylinder Maxum Deadbolt, 1" Faceplate, 2-3/4" Backset	11C624	\$1,147.34	•	
Double Cylinder Maxum Deadbolt, Drive In Front, 2-3/8" Backset	11C625	\$1,147.34	•	
Double Cylinder Maxum, Drive In Front, 2-3/4" Backset	11C626	\$1,147.34	•	
Double Cylinder Maxum Deadbolt, Less Bolt	11C62L	\$1,062.79	•	

•Also Available in Classroom Function, 11C61X

Medeco M³ & X4 CLIQ Maxum Deadbolts – Residential Trim

Description	Part Number	Price	M ³	X4
Single Cylinder Maxum Deadbolt, 1-1/8" Faceplate, 2-3/8" Backset	11R601	\$1,036.84	•	
Single Cylinder Maxum Deadbolt, 1-1/8" Faceplate, 2-3/4" Backset	11R602	\$1,036.84	•	
Single Cylinder Maxum Deadbolt, 1" Faceplate, 2-3/8" Backset	11R603	\$1,036.84	•	
Single Cylinder Maxum Deadbolt, 1" Faceplate, 2-3/4" Backset	11R604	\$1,036.84	•	
Single Cylinder Maxum Deadbolt, Drive In Front, 2-3/8" Backset	11R605	\$1,036.84	•	
Single Cylinder Maxum Deadbolt, Drive In Front, 2-3/4" Backset	11R606	\$1,036.84	•	
Single Cylinder Maxum Deadbolt, Less Bolt	11R60L	\$952.29	•	
Double Cylinder Maxum Deadbolt, 1-1/8" Faceplate, 2-3/8" Backset	11R621	\$1,147.34	•	
Double Cylinder Maxum Deadbolt, 1-1/8" Faceplate, 2-3/4" Backset	11R622	\$1,147.34	•	
Double Cylinder Maxum Deadbolt, 1" Faceplate, 2-3/8" Backset	11R623	\$1,147.34	•	
Double Cylinder Maxum Deadbolt, 1" Faceplate, 2-3/4" Backset	11R624	\$1,147.34	•	
Double Cylinder Maxum Deadbolt, Drive In Front, 2-3/8" Backset	11R625	\$1,147.34	•	
Double Cylinder Maxum Deadbolt, Drive In Front, 2-3/4" Backset	11R626	\$1,147.34	•	
Double Cylinder Maxum Deadbolt, Less Bolt	11R62L	\$1,062.79	•	

Cylinder Technologies are represented by the following letters:
 S = M³ CLIQ, M = X4 CLIQ, V = Medeco Biaxial CLIQ, Z = Medeco Original CLIQ

Padlocks

Medeco M³ & X4 CLIQ padlocks are available to provide accountability in a weather resistant padlock that can be used in indoor or outdoor applications. Padlocks have robust reprogramming abilities, as well as audit and scheduling capabilities. Outstanding performance for your perimeter fences and gates, or access to equipment storage areas where traditional EAC is practically impossible to install.



Medeco M³ & X4 CLIQ Padlock Cylinders

Priced as Pinned. Master Key Up-charge of \$47.50 applies.

Description	Part Number	Price	M ³	X4
Cylinder for AWP Series Padlock	510800	\$879.65	•	•
Cylinder for Medeco Protector II (50) Series Padlock	500020	\$911.50	•	
Cylinder for Medeco System (54) Series Padlock	510600	\$1,093.61	•	•
Cylinder for Abus Padlock Series 83KNK/45, 83KNK/50 & 83KNK/55. (Use Abus driver M)	2020000	\$907.04	•	•
Cylinder for American 3600/3700 Padlock (Use American driver DR-MED6)	2020000	\$907.04	•	•
Cylinder for New Standard Padlock	2020052	\$907.04	•	
Cylinder for Master 20 and 6600, 6700 Pro Series (Use Master driver 0298-627)	2020000	\$907.04	•	•
Cylinder for Schlage 45-101 padlock	2020074	\$909.35	•	•

Medeco M³ & X4 CLIQ AWP Series Padlocks (Includes Cylinder)

Description	Part Number	Price	M ³	X4
AWP - 5/16" dia Stainless Steel shackle, 1-7/8" clearance	5005511	\$1,073.72	•	•
AWP - 5/16" dia Stainless Steel shackle, 2-3/8" clearance	5005521	\$1,078.72	•	•
AWP - 5/16" dia Boron shackle, 1-7/8" clearance	5005531	\$1,073.72	•	•
AWP - 5/16" dia Boron shackle, 2-3/8" clearance	5005541	\$1,078.72	•	•
AWP - 7/16" dia Stainless Steel shackle, 2" clearance	5005711	\$1,073.72	•	•
AWP - 7/16" dia Stainless Steel shackle, 2-1/2" clearance	5005721	\$1,078.72	•	•
AWP - 7/16" dia Boron shackle, 2" clearance	5005731	\$1,073.72	•	•
AWP - 7/16" dia Boron shackle, 2-1/2" clearance	5005741	\$1,078.72	•	•

Cylinder Technologies are represented by the following letters:
 S = M³ CLIQ, M = X4 CLIQ, V = Medeco Biaxial CLIQ, Z = Medeco Original CLIQ

Medeco M³ & X4 CLIQ System Series Padlocks (Includes Cylinder)

Description	Part Number	Price	M ³	X4
Padlock 5/16" Shackle - KIK				
Indoor/Outdoor Padlock, 1-1/8" Shackle Clearance	54515X0	\$1,185.74	•	•
Indoor/Outdoor Padlock, 2-3/8" Shackle Clearance	5451FX0	\$1,189.74	•	•
Shrouded Padlock, 3/4" Shackle Clearance	54525X0	\$1,213.74	•	•
Padlock 5/16" Shackle - 6 Pin LFIC				
Indoor/Outdoor Padlock, 1-1/8" Shackle Clearance	54615X0	\$1,196.15	•	
Indoor/Outdoor Padlock, 2-3/8" Shackle Clearance	5461FX0	\$1,204.15	•	
Padlock 7/16" Shackle - KIK				
Indoor/Outdoor Padlock, 1-3/8" Shackle Clearance	54715X0	\$1,219.74	•	•
Indoor/Outdoor Padlock, 1-7/8" Shackle Clearance	5471FX0	\$1,225.74	•	•
Shrouded Padlock, 3/4" Shackle Clearance	54725X0	\$1,268.74	•	•

* 0 = Non-key retaining and R = key retaining

Medeco M³ CLIQ 50 Series Brass Body Padlock

Priced as Pinned. Master Key Up-charge of \$47.50 applies.

Description	Part Number	Price	M ³	X4
Brass Body CLIQ® Padlock, key retaining, hardened steel shackle, dust cover, less cylinder	50762011	\$222.64		
Brass Body CLIQ® Padlock, key retaining, stainless steel shackle, dust cover, less cylinder	50762111	\$222.64		
Brass Body CLIQ® Padlock, non-key retaining, hardened steel shackle, dust cover, less cylinder	50772011	\$222.64		
Brass Body CLIQ® Padlock, non-key retaining, stainless steel shackle, dust cover, less cylinder	50772111	\$222.64		
Brass Body CLIQ® Padlock, key retaining, hardened steel shackle, dust cover, case cover (rubber), less cylinder	50762014	\$249.75		
Brass Body CLIQ® Padlock, key retaining, stainless steel shackle, dust cover, case cover (rubber), less cylinder	50762114	\$249.75		
Brass Body CLIQ® Padlock, non-key retaining, hardened steel shackle, dust cover, case cover (rubber), less cylinder	50772014	\$249.75		
Brass Body CLIQ® Padlock, non-key retaining, stainless steel shackle, dust cover, case cover (rubber), less cylinder	50772114	\$249.75		
Chain assembly for CLIQ® 50 Series Brass Body Padlock	CP-280271	\$40.60		
Cylinder for CLIQ® 50 Series Padlock: Medeco 6 pin LFIC (M ³ technology)	320201	\$897.27	•	

Cylinder Technologies are represented by the following letters:
 S = M³ CLIQ, M = X4 CLIQ, V = Medeco Biaxial CLIQ, Z = Medeco Original CLIQ

International Cylinders

Medeco's international cylinders are designed to fit in locksets of major world manufacturers. In addition to international uses, many of these cylinders fit imported hardware used in North America. These M³ CLIQ cylinders can be installed into standard hardware with no wiring or other modifications, as power is supplied by the key. Reprogramming, audit and key scheduling capabilities are available with easy to use software. Cylinders are widely used at high security government installations, industrial and institutional organizations, airports, hotels, power plants, palaces, museums, universities and schools, and office buildings.



Medeco M³ CLIQ International Cylinders

Description	Part Number	Price	M ³	X4
Cylinder Module Single/Double 36 mm	2322016 300 S	\$753.51	•	
Cylinder Module Single/Double 41mm	2322016 301 S	\$757.76	•	
Euro Single Assembled 36mm/36mm*	23230X6 X00 S	\$846.25	•	
Euro Double Assembled 36mm/36mm**	23230E6 X00 S	\$901.59	•	
Euro Half 0mm	2323016 800 S	\$846.25	•	
Euro Half 5mm Extended	2323016 801 S	\$850.50	•	

* Standard sizes available from the factory.

** Only one side is electronic, the other is mechanical.

Medeco CLIQ[®] CONNECT Key

Bluetooth Low Energy Enabled Keys

Medeco M³ and X4 CLIQ Intelligent Keys are now available with BLE connectivity. The CLIQ CONNECT Key offers CLIQ remote updates when paired with supported iOS and Android smartphones. The CLIQ CONNECT APP is available as a free download from either App Store and manages the CONNECT Key(s) pairing to the smartphone while reporting key battery level, marking, and system number. Keys are user friendly with visible and audible status feedback, compact in size with water resistant housing, and are powered by an easily replaceable CR2330 battery. Utility patented key control provides protection against unauthorized key duplication.

Connect Key Features:

- Available with RFID/PROX coil
- Visible and audible status feedback
- Compact size in water resistant housing
- New key design, easy battery access
- Powered by an easily replaceable CR2330 coin cell battery, with up to one year battery life
- Available in M³ and X4

CONNECT App Features:

- Bluetooth (BLE) enabled with iOS & Android Apps
- Free App download from Apple or Play Stores
- Obtain remote updates via supported Apple and Android Smartphones
- Key audit report via CONNECT App
- Pair and manage multiple CONNECT keys



Medeco M³ & X4 CLIQ CONNECT Keys

Description	Part Number	Price
X4 CLIQ Dynamic/E3 User Key	KEC 49XB03	\$196.98
M ³ CLIQ Dynamic/E3 User Key	KEC 48XB03	\$196.98
Original/Biaxial CLIQ Dynamic/E3 User Key	KEC 47XB03	\$196.98

Visit www.cliqkey.tips for additional information

Cylinder Technologies are represented by the following letters:
S = M³ CLIQ, M = X4 CLIQ, V = Medeco Biaxial CLIQ, Z = Medeco Original CLIQ

How to Order Medeco CLIQ Keys:

Complete part numbers are required for all orders.
To determine the correct part number, fill in the "Xs" in sequential order.

KEC 48 6 003 LT – base part # example

BUILD A CLIQ KEY PART #:

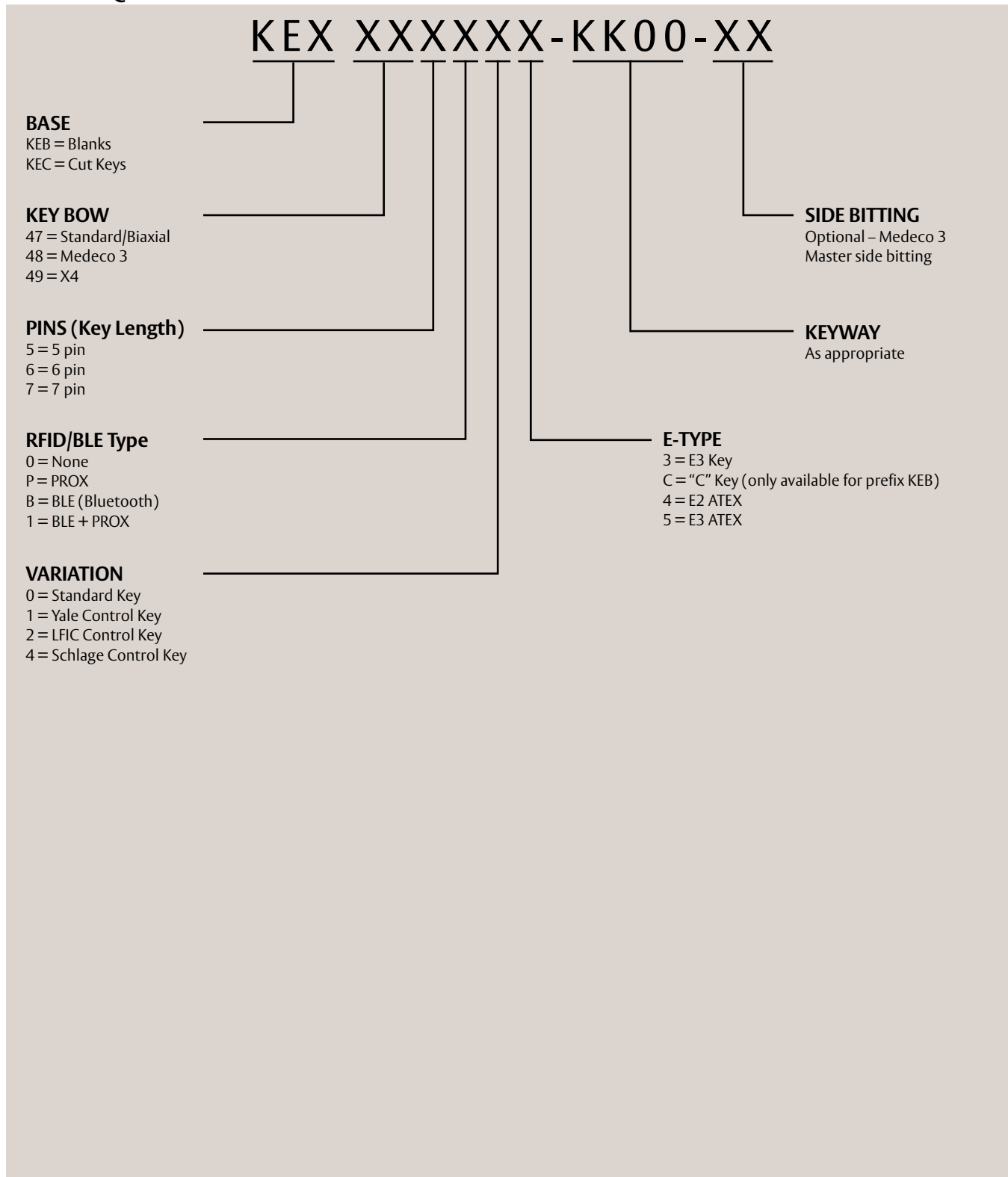

Keys and Accessories

M³ and X4 CLIQ Intelligent Keys operate both CLIQ cylinders as well as compatible mechanical cylinders for unmatched system flexibility and security. Maintaining and ensuring system integrity by means of key audit to obtain historic user access information, as well as the ability to schedule access to doors, is an invaluable tool. M³ and X4 CLIQ keys are also mechanically compatible with M³, M³ BiLevel, and X4 products with the potential to integrate into an already existing key system. Keys are user friendly with visible and audible status feedback, are compact in size with water resistant housing and are powered by an easily replaceable CR2330 battery. Utility patented key control provides protection against unauthorized key duplication.



Visit www.cliqkey.tips for additional information

Medeco M³ & X4 CLIQ Cut Keys

Description	Part Number	Price
X4 CLIQ E3 Dynamic User Key	KEC 49X003	\$153.00
X4 CLIQ E3 Prox Dynamic User Key	KEC 49XP03	\$166.49
X4 CLIQ Yale LFIC Control Key*	KEC 49X013	\$153.00
X4 CLIQ Schlage LFIC Control key**	KEC 497043	\$153.00
<i>*Yale Control Key required if ordering 31 Series IC. Indicate "6" or "7" pin at first "X". Example: KEC496013</i>		
<i>Note: For ATEX certified keys, contact customer service. **Schlage Control key is required if ordering 322201 IC.</i>		
M ³ CLIQ E3 Dynamic User Key	KEC 48X003	\$153.00
M ³ CLIQ E3 Dynamic Prox User Key	KEC 48XP03	\$166.49
M ³ CLIQ LFIC Control	KEC 48X023	\$153.00
M ³ CLIQ Yale LFIC Control Key*	KEC 48X013	\$153.00
<i>*Yale Control Key required if ordering 31 Series IC. Indicate "6" or "7" pin at first "X". Example: KEC486013</i>		
<i>Note: For ATEX certified keys, contact customer service.</i>		
Original/Biaxial CLIQ E3 Dynamic User Key	KEC 47X003	\$153.00
Original/Biaxial CLIQ E3 Prox Dynamic User Key	KEC 47XP03	\$166.49
Original/Biaxial CLIQ LFIC Control Key	KEC 47X023	\$153.00
Original/Biaxial CLIQ Yale LFIC Control Key*	KEC 47X013	\$153.00
<i>*Yale Control Key required if ordering 31 Series IC. Indicate "6" or "7" pin at first "X". Example: KEC476013</i>		
<i>Note: For ATEX certified keys, contact customer service.</i>		
<ul style="list-style-type: none"> • Normal Key systems require Loading Authorizations On Lock via the system C-Key. • Dynamic Key systems require Loading Authorizations On Key via a desktop or remote programming device. 		
<i>Please consult with your Medeco representative to determine which strategy is best for the desired application/installation.</i>		
C-Key for M ³ CLIQ	KEB 48600C	\$195.07
C-Key for Original or Biaxial CLIQ	KEB 47600C	\$195.07
C-Key X4 CLIQ	KEB 49600C	\$195.07
V – Prox Battery Cap Programmed – Black (25)	94-0304-M0P	\$671.00
V – Prox Battery Cap Programmed – Blue (25)	94-0304-MBP	\$671.00
V – Prox Battery Cap, No Programming – Black (25)	94-0305-M0P	\$561.00
V – Prox Battery Cap, No Programming – Blue (25)	94-0305-MBP	\$561.00
Prox Battery Cap, Programmed – Black	E A-500054-M0P	\$42.30
Prox Battery Cap, Programmed – Blue	EA-500054-MBP	\$42.30
CR2330 Replacement Battery (for use in M ³ and X4 CLIQ keys)	EA-350084	\$6.29

Note: For ATEX certified keys, contact customer service.

Programming and Management

CLIQ® Web Manager is a robust and versatile software used by administrators to efficiently manage their CLIQ® System. The CLIQ® Web Manager Hosting Service is cloud-based, giving administrators the ability to manage their system from anywhere with internet access and have the benefit of the latest software enhancements. In addition, it offers secure 24/7 web access and no start-up fees, making it a cost-effective solution to meet a wide variety of needs. Choose the offering that best fits your CLIQ® system size and requirements.



CLIQ® Web Hosting Service

Description	Part Number	Annual License Fee
Basic: Designed for smaller systems and includes desktop/local key and cylinder programming only, Domain Administration. Limit 750 keys.	SW-500101-1	\$1,240.00
Remote Plus: Designed for mid-sized systems and includes Basic features plus remote, mobile and BLE programming, key revalidation, cylinder groups, access profiles, temporary access groups. Limit 750 keys.	SW-500101-3	\$3,893.00
Enterprise: Designed for large systems and includes all Remote Plus features plus web services for 3rd party applications. Limit 1500 keys.	SW-500101-5	\$6,369.00
Enterprise Plus: Designed for systems larger than 1500 keys. Options available for purchase include custom server configuration.		Call for pricing
LenelS2 Onguard: Middleware add-on designed for integration of LenelS2 Onguard with CWM.	SW-601201	Call for pricing
LenelS2 Onguard: Recurring maintenance fee for middleware add-on designed for integration of LenelS2 Onguard with CWM.	SW-601201-R	Call for pricing
AD/LDAP Interface add-on designed for integration of AD/LDAP with CWM.	SW-500150-R	\$2,536.00

Web Hosting custom options available at additional cost include: Dedicated Servers, regulatory compliance configurations, database archiving, Country/Region customization and more. Please contact your local Medeco sales rep for more information.

CLIQ® Self-Hosted Software

Description	Part Number	One-time License Fee	Annual Maintenance Fee
Enterprise Self-Hosted One-Time Fee. Includes all Remote Plus features plus web services for 3rd party applications.	SW-600801	\$59,109.00	
Enterprise Self-Hosted Annual Recurring Maintenance Fee.	SW-600801-6R		\$8,867.00
CLIQ Web Server customer-hosted (Remote Plus). One-time license fee.	SW-600801-7	\$27,020.00	
CLIQ Web Server customer-hosted maintenance (Remote Plus)	SW-600801-7R		\$4,055.00

Self-hosted software purchase entitle the user to a single user license with annual license fees. Software maintenance fee provides regular software program updates, maintenance releases, patches, and technical telephone assistance.

An additional license is required for both Medeco- and Self-hosted customer test server environments.

Multi-year hosting available. Contact your sales representative.

The CLIQ service offerings are billed annually. Annual subscription includes maintenance releases, patches, and normal business hours of basic technical telephone support (M-F). Maintenance fees are billed annually. Annual maintenance subscription includes basic technical telephone support (M-F). For extended technical support, please refer to page 18 for advanced support programs including extended hours and guaranteed response times.

CLIQ Web Manager Client PC minimum requirements: Windows 10 and a modern browser. CLIQ Web Manager is a licensed product for both Medeco Hosted Services and End-User Self Hosted Software.

CLIQ[®] Local Manager

The locally installed CLIQ Local Manager software is used for the day-to-day management of the CLIQ system. With it, system managers can perform a variety of tasks based on the specific needs of their environment, managing access rights of user keys locally via desktop programming devices.

Description	Part Number	Purchase	Annual Rental
CLIQ Local Manager Stand-alone Software version with perpetual license option: Single system application license – One system can be imported into the software with C-key and ELS files. Two years of tech support is included.	SW-500170	\$2,536.00	
Choose the Purchase Option ▲ OR The Annual Subscription Option ▼			
CLIQ Local Manager Stand-alone Software version with recurring license option: Single system application license with Annual maintenance fee.	SW-500170-R		\$761.00
Self-hosted software purchase entitles the user to a single user license with annual license fees. Software maintenance fee provides regular software program updates, maintenance releases, patches, and technical telephone assistance.			

Medeco M³ & X4 CLIQ Programming Devices

Description	Part Number	Price
M ³ CLIQ Local Programming Device (Includes USB Cable)	EA-100168	\$763.00
M ³ CLIQ Remote Wall PD	EA-100256	\$1,254.00
M ³ CLIQ Mobile Programmer	EA-100142	\$1,193.00
M ³ CLIQ Outdoor, Vandal Resistant, Wall Programmer	EA-100160	\$2,258.00
X4 CLIQ Local Programming Device (Includes USB Cable)	EA-100179	\$763.00
X4 CLIQ Remote Wall PD	EA-100257	\$1,254.00
X4 CLIQ Mobile Programmer	EA-100181	\$1,193.00
X4 CLIQ Outdoor, Vandal Resistant, Wall Programmer	EA-100182	\$2,258.00
X4 CLIQ local programming device with one plug (for end users – no plug for C key)	EA-100222	\$659.00
X4 CLIQ Connect mobile programming device	EA-100230	\$1,229.00
M ³ CLIQ Local Programming Device with one plug (for end users – no plug for C key)	EA-100210	\$659.00
M ³ CLIQ Connect Mobile Programming Device	EA-100229	\$1,229.00

Medeco M³ & X4 CLIQ Kits & Accessories

Description	Part Number	Price
Biaxial and M ³ Bottom Pin Kit for use with M ³ CLIQ (Original Product uses standard pin kit)	.KW5401	\$930.00
Metal Cylinder Protector Cove	CP-287260	\$110.00
Plastic Cylinder Protector Cover	CP-170930	\$80.30

New CLIQ Systems Check List

Required	Recommended	Optional	Product Description	Product Comments
●			User Key	Minimum one required per system
●			Cylinder	Minimum one required per system
●			Master C-key	The CLIQ C-Key manages the electronic communication provided by the CLIQ system. It provides users secure access to the system software and the ability to transfer information between the software and cylinders.
●			Sub-master C key	One or more sub-master keys (up to 199 per system)
●			Local Programming Device	The CLIQ Local Programming Device (local PD) is used to connect CLIQ keys and cylinders to the software (CLIQ Web Manager), via secure communication.
	●		Remote indoor wall programming device	Embedded with its own IP address, the online CLIQ Remote Indoor Wall Programming Device allows users to remotely program M ³ CLIQ, X4 CLIQ, and Classic CLIQ keys.
		●	Vandal resistant outdoor wall programming device	Embedded with its own IP address, the online CLIQ Remote outdoor Wall Programming Device allows users to remotely program M ³ CLIQ, X4 CLIQ, and Classic CLIQ keys.
		●	CLIQ Connect (BLE) user key	Used for remote areas. CLIQ Connect (BLE) keys are updated by the CLIQ Connect app using a cell phone. (Only used with CLIQ Web Manager).
		●	CLIQ Connect mobile programming device	Using a cell phone Bluetooth connection and the free CLIQ® Connect app available on iOS or Android phones, the Medeco CLIQ Connect Mobile Programming Device (Connect Mobile PD) allows you to program CLIQ keys on-the-go.
●			CLIQ administrator training	Prior to deployment of your new system, we require Medeco technical training for your business security team. We offer a variety of customized hands-on training courses to teach your team how to properly operate, customize and support your new Intelligent Key System.
	●		CLIQ on-site professional services	To achieve optimum performance of your new intelligent Key System, Medeco recommends professional design and implementation services. Services include system planning, system deployment, team training and on-going support. See the professional services section for more details.
●			CLIQ software – select one of the two choices. 1) CLIQ Web Manager and CLIQ Connect PC or 2) CLIQ Local Manager	Software required for managing the CLIQ system
		●	CLIQ Connect mobile app	Mobile app for Android or iOS available to update user keys (BLE keys or non-BLE keys using CLIQ Connect mobile programming device)
●			CLIQ Control key for Interchangeable cores	CLIQ cylinders can quickly and easily be changed by non-technical personnel using a special control key, applicable only if interchangeable core cylinders are used on a project

Medeco Classic CLIQ®

Medeco Classic CLIQ merges the features of electronics with reliable mechanical technology – all in a retrofit cylinder. Medeco CLIQ offers end users audit trail, user access schedules and the ability to quickly and remotely change Intelligent Key authorizations with the CLIQ Web Manager and Remote.

Medeco Classic CLIQ installs with no wiring in a matter of minutes, and Intelligent Keys and digital cylinder reprogram for electronic master keying.



Audit Accountability

Audit information recorded in both the lock and key shows a time-and-date stamped record of every event, including authorized accesses and unauthorized attempts.



Uses Existing Hardware

The Medeco CLIQ Intelligent Key provides all power to the cylinder, eliminating the need for any hard wiring or power supply. Simply remove the existing mechanical cylinder and install the Medeco Classic CLIQ cylinder.



Reduces Risk of Lost Keys

Respond quickly to security threats, lost or stolen keys or personnel changes utilizing expiring Intelligent Key validation intervals and remote programming.



Electronic Scheduling

Intelligent Keys are programmed for specific openings with fully flexible scheduling. Access profiles can be created where programming updates are generated automatically when an opening is added or removed.

Technical Features:

- **Audits:** Key capacity – 1,000 events
Cylinder capacity – 750 events
- **Management:** CLIQ Web Manager with Medeco Hosted or Self-Hosted License
- **Power:** Power supplied by the key, no hard wiring required
- **Lockcase:** Fits standard Rim & Mortise Housing as well as other various platforms
- **Weather Resistant:** Can be used in indoor or outdoor applications
– Rated for -20° F to 122° F (cylinder)
- **Security:** Encrypted identification in cylinder & Intelligent Key
- **Formats:** Available in all common cylinder formats including KIK/KIL, LFIC, padlocks and deadbolts

Key Information:

- Audit key holds up to 1,000 audit records and provides information unavailable in a mechanical system
- Self-cleaning electronic contact point for a long lasting key and reliable connection
- Powered by an easily replaceable CR2025 Battery with 20,000 cycle battery life
- Available with HID Prox coil insert for dual use with HID compatible EAC systems
- Visible status feedback
- Compact size in water resistant housing

Warranty:

Medeco® warrants the Medeco Classic CLIQ products to be free of defects in material and/or workmanship for a period of two (2) years from date of original purchase

Finishes:

- Available in several finish options

CLIQ Web Manager Features:

- Role based system administration
- Access Profiles
- Remote Programming Web
- Services Integration
- Key Revalidation
- Automated Change Notification

Cylinder Technologies:

- Classic CLIQ Technology code = “C”

Rim and Mortise Cylinders

A simple replacement of rim or mortise cylinders with Classic CLIQ cylinders provides audit and scheduling along with expiration of credentials for any existing opening utilizing mortise hardware. Cylinders are available in all popular lengths and are an ideal upgrade for offices or as override for traditional EAC equipment.



Medeco Classic CLIQ Mortise Cylinders

Description	Part Number	Price
1-1/4" Mortise Cylinder	100500 C	\$998.89
1-3/8" Mortise Cylinder	105100 C	\$995.16
1-1/2" Mortise Cylinder	105200 C	\$1,076.55
1-3/4" Mortise Cylinder	105400 C	\$1,172.47
2" Mortise Cylinder	105500 C	\$1,174.70
2-1/2" Mortise Cylinder	105700 C	\$1,175.13

Medeco Classic CLIQ mortise cylinders are not available longer than 2 1/2"

Medeco Classic CLIQ Rim Cylinders

Description	Part Number	Price
Rim Cylinder – Horizontal Tailpiece	100400H C	\$997.16
Rim Cylinder – Vertical Tailpiece	100400V C	\$997.16
Rim Cylinder – Sargent Mounting Style, Horizontal Tailpiece	100403H C	\$997.16
Rim Cylinder – Sargent Mounting Style, Vertical Tailpiece	100403V C	\$997.16
Rim Cylinder – 180 Degree Lazy Motion	100700 C	\$997.16

Key-In-Knob/Lever Cylinders

Medeco's Key-in-Knob cylinders are designed to retrofit knob type cylindrical locksets, lever type cylindrical locksets, padlocks and bored type auxiliary dead-latches and deadlocks. Medeco Classic CLIQ KIK/KIL cylinders additionally offer user audit trail, user access schedules and the ability to quickly add or remove a key electronically from a system, allowing fast response to security threats or lost/stolen keys. These cylinders fit nearly all popular brands and styles of hardware and are therefore an ideal application for office doors, storage and file rooms, or residential doors; virtually any door where cylindrical hardware is used.



Medeco Classic CLIQ Cylinders for Alarm Lock

Description	Part Number	Price
Cylinder for Alarm Lock Trilogy T1, T2, T3	20200V1 C	\$999.70

**Due to possible variances in hardware tolerance and door preparation, Classic CLIQ KIK cylinders should be field tested in lever or knob applications where the key retracts the latch directly to ensure proper hardware operation.*

Medeco Classic CLIQ Cylinders for Arrow

Description	Part Number	Price
Cylinder Package for Arrow MK Series include CT-Y70, CT-Y73, CP-160321	20200A1 C	\$1,002.01
Cylinder for Arrow RK Series & MK Series (Except Ball),original cylinder spacer must be replaced with Medeco spacer CP-160321	2020070 C	\$999.70
Cylinder for Arrow MK Series (Ball knob only) and GL series	2020073 C	\$999.70
Cylinder for Arrow H & S Knob Series, L, ML, Q, & W Series Lever	2020249 C	\$999.70
Cylinder for Arrow JL Series Interconnected lock, deadbolt cylinder also necessary	2020249 C	\$999.70

Medeco Classic CLIQ Cylinder for Cal-Royal

Description	Part Number	Price
Cylinder for Cal-Royal SL00 Knob Lock and LX01 Lever Lock	2020049 C	\$999.70
Cylinder for Cal-Royal CLS03 Classroom Function Grade 2 Lever Lock	20200V1 C	\$999.70

Medeco Classic CLIQ Cylinder for Corbin Russwin

Description	Part Number	Price
Cylinder for Corbin Russwin CL3900	20200V9 C	\$999.70
Cylinder for Corbin Russwin 800, CL3300, CL3400, CL3500, CL3600	2021173 C	\$999.70
Cylinder for Corbin Russwin CK4200 (new style)	205005 C	\$999.70

Medeco Classic CLIQ Cylinder for Dorma

Description	Part Number	Price
Cylinder for Dorma® CL700 series	2020049 C	\$999.70
Cylinder for Dorma® CL860 (Interior), CL870, CL872, CL873, CL877 Grade 1 Lever, CK860 (Interior), CK870, CK872, CK873, & CK877 Grade 1 Knobs	20200V0 C	\$999.70
Cylinder for Dorma® CL853, CL860 (exterior), CL880, CL882, CL80EL, CL80EU Grade 1 Lever, CK853, CK860 (exterior), CK880, CK882, CK80EL, & CK80EU Grade 1 Knobs	20200V1 C	\$999.70

Medeco Classic CLIQ Cylinder for Embassy

Description	Part Number	Price
Cylinder for Embassy lockset in Entrance, Institution, Storeroom, Corridor functions.	20200V1 C	\$999.70

Medeco Classic CLIQ Cylinder for Hager

Description	Part Number	Price
Cylinder for Hager Lever Locksets, Model 3553,3570,3579,3580	2020249 C	\$999.70

Medeco Classic CLIQ Cylinder for KABA - Mas-Hamilton

Description	Part Number	Price
Kaba E-plex 5000	2020000 C	\$999.70
MAS-Hamilton Power Lever	20200V1 C	\$999.70

Medeco Classic CLIQ Cylinder for LSDA

Description	Part Number	Price
LSDA Cylinder Package Fits 100, L100, LH1000, LX1000 Series. Includes: CT-Y49, CT-Y70 (for 100 Series Knob, except B and L100 Series Lever), CT-Y73 (for 100 Series B knob), CT-Y78 (for LX1000 Lever)	20200L1 C	\$1,002.01

**Due to possible variances in hardware tolerance and door preparation, Classic CLIQ KIK cylinders should be field tested in lever or knob applications where the key retracts the latch directly to ensure proper hardware operation.*

Medeco Classic CLIQ Cylinder for Marks

Description	Part Number	Price
Cylinder for Marks 110, 170, 180, 190, 195, 295 series Vestibule, Communicating, Classroom, & Classroom Security functions (DA, DC, SB, S).	20200V0 C	\$999.70
Cylinder for Marks Lever 110, 170, 180, 190, 195, 295 series in Entrance, Institution, Storeroom, and Corridor functions (AB, DW, F, T)	20200V1 C	\$999.70

Medeco Classic CLIQ Cylinder for Olympus

Description	Part Number	Price
Cylinder for Olympus 700 LCM and 800 LCM Key Retaining cabinet lock, includes: CTY49, CT-Y52, CT-Y53, CT-Y54	20200S1 C	\$1,002.01

Medeco Classic CLIQ Cylinder for PDQ

Description	Part Number	Price
Cylinder for PDQ Lever SP & ST series, GT, XGT & GP Series	20200V2 C	\$999.70

Medeco Classic CLIQ Cylinder for Sargent

Description	Part Number	Price
Cylinder for Sargent 10 line locksets order with '30' option prefix (note: cylinder will extend from lever more than standard cylinder)	20200S1 C	\$1,002.01

Medeco Classic CLIQ Cylinders for Schlage

Description	Part Number	Price
Cylinder Package for Schlage A, AL, C, D, ND & Olympiad lever designs, includes: CT-Y49 (A, AL, & D Olympiad Lever & C & D Plymouth), CT-Y52 (C & D heavy duty knobs Ball, Globe & Sphere designs only), CT-Y53 (A series Orbit), CT-Y73 (ND series Gr. 1 lever & AL thick doors), and CTY74 (45-101 padlock)	20200S1 C	\$1,002.01
Cylinder for Schlage D Series Lever, Athen, Rhodes, & Sparta designs	2020249 C	\$999.70

Medeco Classic CLIQ Cylinder for TACO

Description	Part Number	Price
Cylinder for TACO LXV lever lockset	2020078 C	\$990.70

Medeco Classic CLIQ Cylinder for Yale

Description	Part Number	Price
Cylinder for Yale 6 pin 5300LN, 5400LN and 4300 Knobs	200503 C	\$999.70

**Due to possible variances in hardware tolerance and door preparation, Classic CLIQ KIK cylinders should be field tested in lever or knob applications where the key retracts the latch directly to ensure proper hardware operation.*

Interchangeable Core Cylinders

Medeco Classic CLIQ LFIC cores offer end users the ability to obtain an audit trail, schedule user access rights and quickly and easily remove a key electronically from a system. This cylinder installs into standard Schlage-style LFIC housing hardware with no wiring or other modifications. It is drill and tamper resistant, and ideal for indoor or outdoor installations. Common applications include business entrances such as banks and shopping centers, as well as many school and university applications.



Medeco Classic CLIQ Cylinders for Schlage

Description	Part Number	Price
Classic CLIQ cylinder for Schlage style LFIC	322201 C	\$984.31

Padlocks

Medeco Classic CLIQ retrofit cylinders are available for the Medeco System Series and G8R padlocks, as well as several other popular brands such as American, Schlage or Master. These locks are weather resistant and can be used in indoor or outdoor applications. Padlocks have simple reprogramming abilities, as well as audit and scheduling capabilities for perimeter fences and gates, or for equipment storage areas where traditional EAC is practically impossible to install.



Medeco Classic CLIQ Padlock Cylinders

Description	Part Number	Price
Medeco System Series padlock cylinder (padlock body sold separately)	510600 C	\$1,170.02
G8R Padlock popout cylinder, deadbolt function (padlock body sold separately)	641201 C	\$969.00
G8R Padlock popout cylinder, springbolt function (padlock body sold separately)	641200 C	\$969.00
Cylinder for American 3600/3700 padlock (Use American driver DR-MED6)	2020000 C	\$999.70
Cylinder for New Standard padlocks	2020052 C	\$999.70
Cylinder for Master 20 and 6600, 6700 Pro Series(Use Master driver 0298-627 for Pro Series)	2020000 C	\$999.70
Cylinder for Schlage 45-101 padlock	2020074 C	\$999.70
Cylinder for Abus Padlock Series 83KNK/45, 83KNK/50 & 83KNK/55. (Use Abus driver M)	2020000 C	\$999.70

Medeco Classic CLIQ Padlock Options

Refer to the Padlock Section for System Series and G8R Padlock part numbers and options.

Deadbolts

The Medeco Classic CLIQ Maxum Deadbolt provides a loss and liability solution in Medeco's Maxum deadbolt platform. In addition to the physical security of the Maxum deadbolt, the Medeco Classic CLIQ cylinder provides an audit trail, the ability to schedule user access rights and the freedom to quickly add or remove a key from the system. The Medeco Classic CLIQ deadbolt installs in a matter of minutes without cumbersome wiring. Attack-resistant design and tamper-proof features provide strong protection against forced entry and allow for flawless integration into any home or business application.



Medeco Classic CLIQ Deadbolt Cylinders

Description	Part Number	Price
Cylinder for Arrow D, E & DB Series Single Cylinder Deadbolts	200901 C	\$1,000.70
Cylinder for Arrow Revolution deadbolt	200901 C	\$1,000.70
Cylinder for Sargent 470 & 480 single cylinder deadbolt	200901 C	\$1,000.70
Cylinder for Sargent 470 & 480 double cylinder deadbolt	200902 C	\$1,000.70
Lazy Motion Cylinder for Schlage B series (old style) deadbolt	200904 C	\$1,000.70

Medeco Classic CLIQ Maxum Deadbolts – Commercial Trim

Description	Part Number	Price
Single Cylinder Maxum Deadbolt, 1-1/8" Faceplate, 2-3/8" Backset	11C601 C	\$1,139.59
Single Cylinder Maxum Deadbolt, 1-1/8" Faceplate, 2-3/4" Backset	11C602 C	\$1,139.59
Single Cylinder Maxum Deadbolt, 1" Faceplate, 2-3/8" Backset	11C603 C	\$1,139.59
Single Cylinder Maxum Deadbolt, 1" Faceplate, 2-3/4" Backset	11C604 C	\$1,139.59
Single Cylinder Maxum Deadbolt, Drive In Front, 2-3/8" Backset	11C605 C	\$1,139.59
Single Cylinder Maxum, Drive In Front, 2-3/4" Backset	11C606 C	\$1,139.59
Single Cylinder Maxum Deadbolt, Less Bolt	11C60L C	\$1,055.04

Available Classroom Function, 11C61X C.

Medeco Classic CLIQ Maxum Deadbolts – Residential Trim

Description	Part Number	Price
Single Cylinder Maxum Deadbolt, 1-1/8" Faceplate, 2-3/8" Backset	11R601 C	\$1,139.59
Single Cylinder Maxum Deadbolt, 1-1/8" Faceplate, 2-3/4" Backset	11R602 C	\$1,139.59
Single Cylinder Maxum Deadbolt, 1" Faceplate, 2-3/8" Backset	11R603 C	\$1,139.59
Single Cylinder Maxum Deadbolt, 1" Faceplate, 2-3/4" Backset	11R604 C	\$1,139.59
Single Cylinder Maxum Deadbolt, Drive In Front, 2-3/8" Backset	11R605 C	\$1,139.59
Single Cylinder Maxum Deadbolt, Drive In Front, 2-3/4" Backset	11R606 C	\$1,139.59
Single Cylinder Maxum Deadbolt, Less Bolt	11R60L C	\$1,055.04

Cam and Utility Locks

Medeco® Classic CLIQ Cam Locks are recognized throughout the world as the standard for protection. Medeco offers a complete line of various cam lock sizes and functions to meet your specific needs. In addition to providing the ultimate defense against drilling, pulling, and other forms of vandal attacks, locks have both electronic auditing and scheduling capabilities that offer further security in many applications. Storage cabinets, vending machines, lockers and tool boxes can all be accommodated without any wiring and be utilized in either indoor or outdoor use.



Medeco Classic CLIQ Cam Locks

Description	Part Number	Price
7/8" Cam lock	60810 XXX C	\$973.00
7/8" Cam lock with hardened plug face	60810D XXX C	\$1,056.83
1-1/8" Cam lock	60820 XXX C	\$973.00
1-1/8" Cam lock with hardened steel plug face	60820D XXX C	\$1,056.83

Medeco Classic CLIQ Cam Lock Codes

Description	Op Code
1 Flat, 1 Key Pull, Clockwise 90 degree	119
2 Flat, 1 Key Pull, Clockwise 90 degree	219
2 Flat, 2 Key Pull, Clockwise 90 degree	229
2 Flat, 1 Key Pull, Counterclockwise 90 degree	239
2 Flat, 2 Key Pull, Counterclockwise 90 degree	249
2 Flat, 1 Key Pull, Clockwise 180 degree	259
2 Flat, 2 Key Pull, Clockwise 180 degree	269

Retail/Showcase Cylinders

Medeco Classic CLIQ Showcase and Cabinet Locks offer end users audit trail, user access schedules and the ability to quickly add or remove a key electronically from a system. Installs with no wiring in a matter of minutes, and electronic keys and cylinders reprogram for instant changes. With ease of tracking capabilities, in a retail environment these locks are ideal to protect against both customer and employee theft, and to allow efficient access for sales associates with full audit accountability. Available to fit many types of display cases, as well as cash drawers and inventory cabinets.



Medeco Classic CLIQ Cabinet Locks

Description	Part Number	Price
Plunger Lock, Round Bolt	490358 C	\$1,151.00
Plunger Lock, T- Bolt	490368 C	\$1,151.00
Cabinet Lock, Latchbolt	490359 C	\$1,119.74
Cabinet Lock, Deadbolt	490366 C	\$1,119.74
Showcase Ratchet Lock	490361 C	\$1,100.70

International Cylinders

Medeco's International Cylinders are designed to fit in locksets of major world manufacturers. In addition to international uses, many of these cylinders fit imported hardware used in North America. These Medeco Classic CLIQ cylinders can be installed into standard hardware with no wiring or other modifications, as power is supplied by the key. Reprogramming, audit and key scheduling capabilities are available with easy to use software. These cylinders are widely used at high security government installations, industrial and institutional organizations, airports, hotels, power plants, palaces, museums, universities and schools, and office buildings.

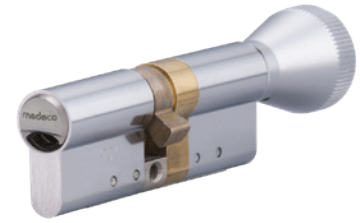

Medeco Classic CLIQ International Cylinders

Description	Part Number	Price
Thumbturn Profile - Assembled 30/30mm	2325005 C	\$1,201.00
Double Cylinder Profile - Assembled 30/30mm	2325025 C	\$1,717.00

Vending Cylinder Formats

Medeco Classic CLIQ specialty cylinders offer industrial or route management vendors electronic control over their assets. Medeco Classic CLIQ offers end users audit trail, user access schedules and the ability to quickly add or remove a key electronically from a system. Installs with no wiring in a matter of minutes and electronic keys and cylinders reprogram for instant changes. Audit information recorded in both the lock and key shows a time-and-date stamped record of every event, including authorized accesses and unauthorized attempts. Medeco Classic CLIQ products add a wide variety of intelligent features without compromising on physical security. Attack-resistant design and tamper-proof features provide strong protection against forced entry.



Medeco Classic CLIQ International Cylinders

Description	Part Number	Price
CLIQ Pop-out Cylinder, Springbolt	641200 C	\$969.00
CLIQ Pop-out, Springbolt, Hardened Plug	641200D C	\$1,052.83
CLIQ Pop-out Cylinder, Deadbolt	641201 C	\$969.00
CLIQ Pop-Out Cylinder, Deadbolt, Hardened Plug	641201D C	\$1,052.83

Keys and Accessories

Medeco Classic CLIQ Intelligent Keys operate Classic CLIQ cylinders for system flexibility and security they maintain and ensures system integrity by means of key audit to obtain historic user access information, as well as the ability to schedule access to doors. Keys are user friendly with visible LCD status feedback, compact in size with water resistant housing and are powered by an easily replaceable CR2025 battery.



Medeco Classic CLIQ Keys

Description	Part Number	Price
E2/Normal User Key - Key Only	KEC 42602B	\$170.62
E3/Dynamic User Key - Key Only	KEC 42603B	\$170.62
C-Key	KEC 4260CR	\$217.69
E2/Normal User Key with 125kHz PROX Cover	KEC 426P2B	\$184.11
E3/Dynamic User Key with 125kHz PROX Cover	KEC 426P3B	\$184.11
CLIQ Battery Cover w/Proximity-upgrade standard Medeco Classic CLIQ keys to RFID Proximity Keys (sold in pack of 25) – Black only	94-0249	\$490.00

- Normal Key systems require Loading Authorizations On Lock via the system C-Key.
 - Dynamic Key systems require Loading Authorizations On Key via a desktop or remote programming device.
- Please consult with your Medeco Intelligent Key representative to determine which strategy is best for the desired application/installation.*

Medeco Classic CLIQ Programming Devices

Description	Part Number	Price
Medeco Classic CLIQ Local Programming Device (Includes USB Cable)	EA-100167	\$763.00
Remote Wall PD for Medeco Classic CLIQ	EA-100297	\$1,254.00
Medeco Classic CLIQ Mobile Programmer	EA-100145	\$1,193.00
Outdoor, Vandal Resistant, Wall Programmer for Medeco Classic CLIQ keys	EA-100159	\$2,258.00
CLIQ Connect Mobile PD	EA-100258	\$1,122.00

Medeco Classic CLIQ Kits & Accessories

Description	Part Number	Price
Plastic Cylinder Protection Cover	CP-170930	\$80.30
Metal Cylinder Protection Cover	CP-287260	\$110.00

End-User Startup Checklist:

- CLIQ Web Manager
- CLIQ Local Programmer
- CLIQ C Key
- Remote Wall and/or Mobile Programmers
- User Keys

Professional Services

Planning, design and support are crucial to the successful deployment of an Intelligent Key System. Medeco offers professional services to ensure every installation is planned and executed seamlessly, and the system works effectively to meet current and future needs to protect the investment. See page 18 for details and pricing.

Programming and Management

CLIQ® Web Manager is a robust and versatile software used by administrators to efficiently manage their CLIQ® System. The CLIQ® Web Manager Hosting Service is cloud-based, giving administrators the ability to manage their system from anywhere with internet access and have the benefit of the latest software enhancements. In addition, it offers secure 24/7 web access and no start-up fees, making it a cost-effective solution to meet a wide variety of needs. Choose the offering that best fits your CLIQ® system size and requirements.



CLIQ® Web Hosting Service

Description	Part Number	Annual License Fee
Basic: Designed for smaller systems and includes desktop/local key and cylinder programming only, Domain Administration. Limit 750 keys.	SW-500101-1	\$1,240.00
Remote Plus: Designed for mid-sized systems and includes Basic features plus remote, mobile and BLE programming, key revalidation, cylinder groups, access profiles, temporary access groups. Limit 750 keys.	SW-500101-3	\$3,893.00
Enterprise: Designed for large systems and includes all Remote Plus features plus web services for 3rd party applications. Limit 1500 keys.	SW-500101-5	\$6,369.00
Enterprise Plus: Designed for systems larger than 1500 keys. Options include custom server configuration, FedRAMP compliance.		Call for pricing
<i>These offerings are billed annually.</i>		

Web Hosting custom options available at additional cost include: Dedicated Servers, regulatory compliance configurations, database archiving, Country/Region customization and more. Please contact your local Medeco sales rep for more information.

CLIQ® Self-Hosted Software

Description	Part Number	One-time License Fee	Annual Maintenance Fee
Enterprise Self-Hosted One-Time Fee. Includes all Remote Plus features plus web services for 3rd party applications.	SW-600801	\$59,109.00	
Enterprise Self-Hosted Annual Recurring Maintenance Fee.	SW-600801-6R		\$8,867.00
CLIQ Web Server customer-hosted (Remote Plus). One-time license fee.	SW-600801-7	\$27,020.00	
CLIQ Web Server customer-hosted maintenance (Remote Plus).	SW-600801-7R		\$4,055.00
<i>Maintenance fees are billed annually.</i>			
Self-hosted software purchases entitle the user to a single user license with no annual license fees. However, the software maintenance fee is recommended and provides regular software program updates, maintenance releases, patches, and technical telephone assistance.			

CLIQ Web Manager Client PC minimum requirements: Windows 10 and a modern browser. CLIQ Web Manager is a licensed product for both Medeco Hosted Services and End-User Self Hosted Software.

Medeco® XT

Medeco® XT Intelligent Key Ecosystem

Building on Medeco's 55-year history of creating high security key control products, the Medeco XT Intelligent Key Ecosystem takes key systems to a completely new level.

Medeco XT adds security, regulatory compliance and accountability to practically every opening in a fast, efficient way. A Medeco XT Ecosystem enhances businesses by providing the valuable data and tools needed to be more profitable or meet compliance requirements.

Overview: The Medeco XT Ecosystem consists of a robust electronic locking and access control system that is managed by state-of-the-art web based system software.

Medeco XT overcomes current keying issues by keeping security high even if someone loses a key.

Medeco XT also adds access control capability in hard to reach areas such as safes, cabinets, gates (padlocks), etc. In addition, with the new AIM (Access Interface Module) Device, imagination is your only limitation regarding what to control next with your XT key.



Audit Accountability

Audit information recorded in both the lock and key shows a time- and date-stamped record of every event, including authorized accesses and unauthorized attempts.



Uses Existing Hardware

Medeco XT key provides all power to the cylinder, eliminating the need for any hardwiring or power supply. Simply remove the existing mechanical cylinder and install the Medeco XT cylinder.



Reduces Risk of Lost Keys

Respond quickly to security threats, lost or stolen keys, or personnel changes without the added cost of changing your locks and keys.



Electronic Scheduling

Keys are electronically programmed to open only specific locks during a designated schedule. Schedules may also contain an expiration point to completely disable the key until it is audited and reprogrammed.



Medeco Data Dashboard

System audit data is displayed in a new graphical way on the Medeco dashboard. The 'Glances' display consists of several mini-dashboards that provide insight into your system configuration and audit events.



Data Analytics

The Visual Audit feature of Medeco XT Web manager software converts audit data into a simple graphic dashboard. Security Administrators can see access trends and irregularities at a glance!

Key Features:

- Small, robust electronic key with stainless steel housing
- Intelligent key holds all access and schedule data
- Rechargeable battery
- Stand-alone, network, Web and mobile programming options

Warranty:

Medeco Security Locks warrants Medeco XT products to be free of defects in material and/or workmanship for a period of two (2) years from date of original purchase (except where noted).

Extended warranty available at time of purchase, see page 13 (Warranty Information) for additional information.

Product Specifications:

Lock / Cylinder Features

- No wiring required—all power provided by the key
- Indoor / outdoor use—stainless steel shell construction
- 2,000 audit events
- Unauthorized key list
- Variety of retrofit cylinder formats

XT Software and Options:

XT Software and Options: The Medeco XT Web Manager software is an integral part of the Medeco XT Ecosystem. The software not only helps manage the XT Intelligent Key System in flexible and cost-effective manner, but also provides business-enhancing tools.

The XT Web Manager SaaS (Software as a Service) software is available as either a Medeco-hosted or End-user hosted option. The Medeco-hosted option takes advantage of the power, convenience and security of Amazon Web Services (AWS) and is offered in several pricing levels. This option offers high-availability, secure web access, no start-up fees, and a multitude of AWS optional services to meet any customer's needs.

All Admin functions are handled by trained and certified IT personnel. Medeco holds ISO 27001 Certification for internal information and asset security.

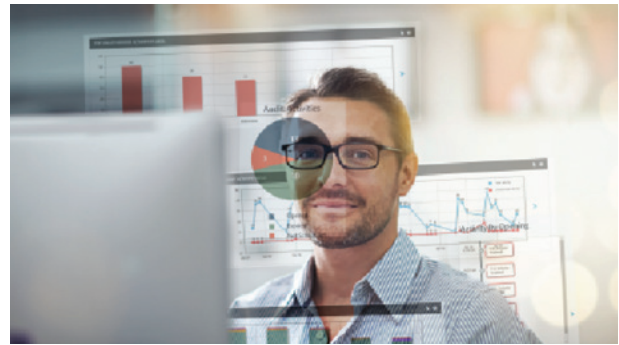

Medeco-AWS Hosted Options:

Description	Part Number	Annual License Fee
Enterprise: Medeco can create a custom offering for large enterprise class systems that need more options to support their needs (see Web Hosting below). Speak to your local sales representative for more details.	Note: Depends on options and # of keys	Custom quoted
Premium: Includes all the functionality of Advanced plus, access to other custom AWS services, and Pro Service Remote Training and support (4 hours annually — a \$2,660 value). Limit 1,500 keyholders.	SW-500301-4	\$6,369.00
Advanced: Designed for mid-size systems. Adds Remote & Mobile programming & extended schedules to the Basic version. Limit 750 keyholders.	SW-500301-3	\$3,893.00
Basic: Designed for smaller systems: Effectively manage your XT Intelligent Key system with all the basic functionality which includes Schedules, Audit, Groups, Data Dashboard & Visual Audit. Limit 250 keyholders.	SW-500301-2	\$1,240.00
<p>Web Hosting custom options available at additional cost include: Dedicated Server for very large systems, regulatory compliance configurations, database archiving, Country/Region customization and more. Please contact your local Medeco sales rep for more information.</p> <p>Multi-year hosting available.</p> <ul style="list-style-type: none"> • Dedicated Server for large systems • Country/Region customization • Regulatory compliance configurations • Custom database archiving • Multi-Year Hosting 		
<i>These offerings are billed annually.</i>		

Medeco-AWS Hosted Service – End User Startup Checklist:

Description	Quantity	Part Number	Price
XT Programming Device	1	EA-100109	\$390.00
USB Cable	1	EA-200058	\$38.10
Deoxit Contact Cleaning Pen (gold contact cleaner)	1	CP-301290	\$85.70

Medeco XT Self-Hosted Software

These systems are set up and hosted by the End-User: End-User is responsible for supplying all necessary hardware & expertise for server set up, maintenance, backups, etc.

See Professional Services section for assistance with configuration and set up of your XT system.

Description	Part Number	One-Time Fee	Annual Fee
*XT Enterprise Self-Hosted Software. All the features of the Advanced version along with support for very large systems plus more advanced and/or future functionality.	SW-600901-1	\$59,109.00	
Enterprise Self-Hosted Annual Recurring Maintenance Fee – receive all software updates and bug fix releases, installation support, and an additional software license for a test server.	SW-600901-1R		\$8,867.00
XT Enterprise Self-Hosted Software with XT IKC Support	SW-600901-2	\$60,212.00	
*XT Advanced Self-Hosted Software: for mid to large systems. Includes features such as Remote and Mobile programming, Visual Audit, Who has Access reporting, etc.	SW-600901	\$27,020.00	
Advanced Self-Hosted Annual Recurring Maintenance Fee – receive an additional software license, software updates and bug fixes and installation support.	SW-600901-R		\$4,055.00
*XT SOLO – Same interface as our XT Web based software but designed for standalone applications. Does not support Remote or Mobile programming.	SW-500301-1	\$1,645.00	
XT SOLO Software Maintenance Fee – receive software updates and installation support for same	SW-500301-1R		\$329.00
API Interface available for custom applications/integrations	Contact your local sales representative for more details.		
<i>Maintenance fees are billed annually.</i>			
<p>Self-hosted software purchases entitle the user to a single user license with no annual license fees. Purchase also entitles user to an additional license for an on-site test server. (Medeco always recommends introducing a new version of software to a test server before deploying to their live system.)</p> <p>Recurring maintenance is recommended and provides an additional license for test server, regular software program updates, maintenance releases, patches, and basic level technical telephone assistance.</p> <p>Customers who are not paying the recurring maintenance fee but that wish to upgrade their XT Web Manager software must contact their dealer or Medeco Representative for a quote.</p> <p>Note: Medeco Tech support cannot support software versions that are over two years old without the addition of Professional Services</p>			

* Also requires the purchase of a system setup dongle. Part number EA-250059.

Self-Hosted Software – End User Startup Checklist:

Description	Quantity	Part Number	Price
XT Programming Device	1	EA-100109	\$390.00
USB Cable	1	EA-200058	\$38.10
Enhanced USB System Dongle	1	EA-250059	\$116.00
Deoxit Contact Cleaning Pen (gold contact cleaner)	1	CP-301290	\$85.70

Medeco® XT Intelligent Keys

Medeco® XT Electronic Locking Systems

The Medeco XT keys are small, robust, convenient and portable. They are built to withstand even the toughest environments.

The Medeco XT keys have dynamic memory which can adjust the number of audit transactions and cylinder access the key can store. Medeco XT keys also utilize a rechargeable battery and can be purchased with a portable charger to ensure you are never locked out due to a dead battery. The key provides feedback to indicate when a charge is required.

There are two key models in the XT line. The 'Slim Line' key is designed for just about every application except those extreme and abusive environments, where the 'Rugged' key is recommended.



G3R Rugged Key Features:

- Hardened stainless steel housing that will stand up in the toughest environments
- Portable and rechargeable
- Top-mounted LED for convenient access feedback

G3R Rugged Key Applications:

The XT Rugged key was designed for users that want a small, robust credential that will stand up to the most extreme environments. Tested for drop, shock and temperature extremes.

Slim Line Key Features:

- Polished, hardened stainless steel frame for strength and durability
- Soft-touch coating
- Dual-LED indicators for greater visibility
- Raised orientation dimples (allow for feeling the orientation of the key) for easier use
- High-capacity memory

Slim Line Key Applications:

The XT Slim Line key was designed for users that want a small, light credential that will not sacrifice on durability. Created to stand up to all but the most extreme environments but designed to be one of the most portable and desirable keys on the market!

Bluetooth Key Features:

- Utilizes Bluetooth Smart Technology
- Program keys from any location (within cellular coverage area)
- No need to 'dock' key to program
- Works with the latest XT Web Manager software



NEW: Slim Rugged



- Storage of 10,000 audit events
- Extremely durable
- Stainless steel and aluminum construction
- Support for remote and mobile programming
- Rechargeable

Slim Line S



- Higher intelligence to support more advanced features
- Enhanced user experience with faster processing and programming speeds

Slim Line B Bluetooth Key



- All the Slim Line S features and...
- Program anywhere
- Bluetooth communication built-in
- Smartphone app support
- Immediate upload/download of data (if desired)

See page 51 for additional details and technical information.

Keys and Accessories

The Medeco® XT Key is a convenient, robust electronic key with a heavy duty stainless steel housing that fits right on your key ring. A portable key charger and rechargeable battery assures keys are always fully charged for up to 1,800 openings, eliminating the need for battery maintenance. Convenient key programming and flexible system management eliminates the need for removal of cylinder in order to make changes. This key holds operating and expiration schedule and flexible memory allocation lets the user decide how the memory is used. Audit: up to 14,000 events. With Medeco XT, flexible authorization, auditing of use and quick retrofit to existing hardware are all available in one convenient package.



XT Keys

Description	Part Number	Price
XT G4S - Slim Key	EA-100293	\$185.00
XT Slim Line Key Bluetooth (G3B)	EA-100177	\$233.00
XT G4R - Slim Rugged Key	EA-100292	\$233.00
Slim Line Demo/Install Key	EA-100173	\$297.00
Slim Line Demo/Install Control Key	EA-100174	\$297.00

Medeco® XT Key Bundles

Description	Part Number	Price
XT Slim Key (G4S) Charger Bundle. Includes XT Slim Key G4S, Charger and USB Cable	94-0331	\$247.00
XT Slim Rugged Key (G4R) & Charger Bundle. Includes XT Slim Rugged Key, Charger and USB Cable	94-0330	\$275.00
XT Slim Line Key (G3B) & Charger Bundle. Includes XT Slim Line Key, Charger and USB Cable	94-0306	\$292.00

	Slim Line S (Gen 3)	Slim Line B (Gen 3)	Rugged (Gen 3R)
Description	Faster processor, faster communication, support for future functionality	Bluetooth version. Faster processor, faster communication, support for future functionality	Same functionality as G3S key with a rugged housing for increased durability.
Part Number	EA-100178	EA-100177	EA-100254
Size	2.65" x 1.25" x .55"	2.65" x 1.25" x .55"	2.65" x 1.25" x .59"
Weight	1.25 oz.	1.25 oz.	1.25 oz.
Openings per charge	1500-1800	1500-1800	1500-1800
Durability	High	High	Very High
Audit	14,000 events	14,000 events	14,000 events
Battery Level Indicator Expected battery life – 5-10 years*	Percentage	Percentage	Percentage
Warranty	2 years	2 years	2 years

* Depending on amount of usage.
Extended warranty available for purchase. See Page 13 for more details.



IPD – Identification and Programming Device

Medeco XT Programmers

XT IPD - Identify, program and update Medeco XT Keys remotely via internet connection to Web Manager software

XT IPD	Part Number	Price
XT IPD Base unit with power supply	EA-100242-000	\$2,162.00
XT IPD Base unit, desktop mount and power supply bundle	EA-100242-010	\$2,305.00
XT IPD Base unit, wall mount and power supply bundle	EA-100242-100	\$2,305.00
XT IPD Standoff Retrofit Kit - spacer kit for replacing existing Remote Programmer when mounted in a custom enclosure	EA-300241	\$99.90
XT IPD Replacement Touchscreen assembly	EA-100245	\$1,008.00
7/8" Cam Lock – Can be added to IPD for users to test keys. (Optional)	EN-150002-XXX	\$410.00



Desktop Programmer

Desktop	Part Number	Price
XT Desktop USB Programming Station (order cable separately)	EA-100109	\$390.00



Mobile Programmer

Mobile	Part Number	Price
XT Mobile Programmer	EA-100125	\$1,164.00



Multi-Key Programmer/Charger

Multi-key	Part Number	Price
XT Multi-key Programmer/Charger	EA-100232	\$5,455.00

Medeco® XT Kits & Accessories

Description	Part Number	Price
XT Multi-Key Charger - Charge up to 10 Medeco XT Keys simultaneously (does not program keys)	EA-100138	\$892.00
XT Portable Key Charging Adapter only (order cable separately)	EA-100088	\$81.40
XT Key Wall Charger Kit	94-0291	\$143.00
XT Key Vehicle Charger Kit	94-0292	\$141.00
XT Key PC Kit (USB Cable and Charging Adapter)	94-0290	\$105.00
Smart SFIC Solutions Demo Kit (Includes Arrow, Medeco X4, and Medeco XT SFIC cylinders, keys, charger and cable)	940261	\$1,737.00

Medeco® XT Maintenance and Protective Products

Description	Part Number	Price
Fluid Film, 2.25 oz	PX-KYLUBE-02	\$23.90
Fluid Film, 11.75 oz	PX-KYLUBE-11	\$37.90
Small Bristle Brush (non-metallic bristles) for cleaning cylinder & key contacts	CP-286180	\$36.00
Deoxit Contact Cleaning Pen (gold contact cleaner)	CP-301290	\$85.70
Metal cylinder protector cover	CP-287260	\$110.00
Plastic cylinder protector cover	CP-170930	\$80.30

Professional Services

Planning, design and support are crucial to the successful deployment of an Intelligent Key System. Medeco offers professional services to ensure every installation is planned and executed seamlessly, and the system works effectively to meet current and future needs to protect the investment. See page 19 for details and pricing.

XT Finishes

XT SFIC cylinders are only available in the finishes shown to the right. Finishes for all other XT cylinders can be seen on the inside back cover.

NOTE: For XT SFICs only, due to the complexity of the process, there is a \$42 fee for custom finishes (other than 26, which is standard).



Rim and Mortise Cylinders

For availability of cylinder formats not shown, contact Technical Support.

XT Rim and Mortise electronic cylinders are a simple and direct replacement for mechanical cylinders. Ideal for loss & liability management with flexible authorization and auditing capabilities. Respond quickly to security threats, lost or stolen keys, or personnel changes without the added cost of changing your locks and keys. Medeco XT is a complete electronic locking system providing controlled access, accountability, physical security, and system management with no wiring requirements. Cylinders are available in many popular lengths and finishes to fit nearly any application in your office, business and retail applications.



Mortise Cylinder



Rim Cylinder

XT Rim and Mortise Cylinders

Description	Part Number	Price
Rim Cylinder, horizontal tailpiece	100400H G*	\$395.87
Rim Cylinder, vertical tailpiece	100400V G*	\$395.87
1 1/4" Mortise Cylinder	100500 G*	\$399.31
1 3/8" Mortise Cylinder	105100 G*	\$395.25

*Must specify cam (mortise) or tailpiece (rim) when ordering. See pages 83-84 for cam and tailpiece part numbers and descriptions. If not specified, Z01 cam will be supplied for mortise, Y02 tailpiece will be supplied with rim cylinders.

Interchangeable Core Cylinders

XT Small Format Interchangeable Core (SFIC) is ideal for access management as a direct replacement for mechanical SFIC without any hardware modifications. An easy-to-upgrade solution, ready to install and use without wiring or power supply, XT SFIC is easily installed or removed to existing hardware with the simple use of a programmed control key. Users can audit keys, program a schedule and track who opens a lock and when – all while eliminating the cost of rekeying mechanical locks. Well suited for facilities with high turnover of employees, such as fast food restaurants, convenience stores, and similar businesses, but is also suitable for apartments, office buildings, schools, and hospitals. Available in custom finishes.



SFIC

LFIC

XT Small & Large Format Interchangeable Core

Description	Part Number	Price
Small Format Interchangeable Core (SFIC) Cylinder	EA-100108	\$427.00
Schlage Large Format Interchangeable Core (LFIC) Cylinder*	322201 G	\$397.73
Yale Large Format Interchangeable Core (LFIC) Cylinder* 6 pin	310100 G	\$402.05
Yale Large Format Interchangeable Core (LFIC) Cylinder* 7 pin	310100A G	\$402.05
Sargent Large Format Interchangeable Core (LFIC) Cylinder 6 pin	322401 G	\$404.52
Corbin Large Format Interchangeable Core (LFIC) Cylinder 6 and 7 pin (includes spacer)	322301 G	\$404.52

* Fits LFIC format housing, but is a one-time installation and not removable.

See page 114 for LFIC housings.
See page 122 for SFIC housings.

Key-In-Knob/Lever Cylinders

XT Key-in-Knob/Lever electronic cylinder is a direct replacement for mechanical KIK/KIL cylinders and is ideal for access control management. The cylinder requires no wiring to the door and is powered by the XT rechargeable key. Audit trail, user access schedules and the ability to quickly add or remove a key electronically from a system allow for fast response to security threats, lost or stolen keys, or personnel changes without the added cost of changing locks and keys. Designed for quick retrofit of nearly all popular brands of knob and lever-type cylindrical locksets, making them an ideal application for office doors, storage and file rooms, or residential doors: virtually any door where cylindrical hardware is used.



XT Arrow Cylinders

Description	Part Number	Price
Medeco XT cylinder for all Arrow RK & MK series knobs and GL series levers. For RK & MK series, replace original spacer with Medeco CP-160321 (included)	20200A1 G	\$401.60

XT Cylinders for Cal-Royal

Description	Part Number	Price
Cylinder for Cal-Royal Apollo series SL00 knob lock and LX01 lever lock	2020049 G	\$399.29
Cylinder for Cal-Royal CLS03 classroom function Gr. 2 lever lock	20200V1 G	\$399.29

XT Cylinders for Corbin Russwin

Description	Part Number	Price
Cylinder for Corbin 800 lever lockset CL3300, CL3400, CL3500 & CL3600	2020073 G	\$399.29
Cylinder for Corbin Russwin CL3900 series leversets	20200V9 G	\$399.29

XT Cylinders for Falcon

Description	Part Number	Price
Cylinder for Falcon B, LY, X, S & T series. Includes: CT-V03, CT-Y49, CT-Y54, CT-Y58, CTY68, CT-Y71, CT-Y72, CP-160311	20200F1 G	\$401.60
Cylinder for Falcon F521, F561, F581, and N series knobs	2020051 G	\$399.29
Cylinder for Falcon T-381 (inside)	2020073 G	\$399.29
Cylinder for Falcon T & RU series, T381 (exterior)	20200V3 G	\$399.29

XT Cylinders for KABA-Mas-Hamilton

Description	Part Number	Price
Cylinder for Kaba E-plex 5000	2020000 G	\$399.29
Cylinder for Mas-Hamilton Power Lever	20200V1 G	\$399.29

XT Cylinders for LSDA

Description	Part Number	Price
LSDA cylinder package fits 100, L100, LH1000, LX1000, Includes: CT-Y49, CT-Y70, CT-Y73, CTY78	20200L1 G	\$401.60

XT Cylinder for Marks

Description	Part Number	Price
Cylinder for Marks 110, 170, 180, 190, 195, 295 series Vestibule, Communicating, Classroom, & Classroom Security functions (DA, DC, SB, S).	20200V0 G	\$399.29
Cylinder for Marks Lever 110, 170, 180, 190, 195, 295 series in Entrance, Institution, Storeroom, and Corridor functions (AB, DW, F, T)	20200V1 G	\$399.29

XT Cylinders for Olympus

Description	Part Number	Price
Cylinder for Olympus 700 LCM & 800 LCM Key Retaining	20200S1 G	\$401.60

XT Cylinders for PDQ

Description	Part Number	Price
Cylinder for PDQ Lever SP & ST Series, GT, XGT, & GP Series	20200V2 G	\$399.29

XT Cylinders for Sargent

Description	Part Number	Price
Cylinder for Sargent 10 line locksets, order with '30' option prefix (note: cylinder will extend from lever more than standard cylinder)	20200S1 G	\$401.60

XT Cylinders for Schlage

Description	Part Number	Price
Cylinder Package for Schlage A, AL, C, D, ND & Olympiad lever designs, includes: CT-Y49 (A, AL, & D Olympiad Lever & C & D Plymouth), CT-Y52 (C & D heavy duty knobs Ball, Globe & Sphere designs only), CT-Y53 (A series Orbit), CT-Y73 (ND series Gr. 1 lever & AL thick doors), and CTY74 (45-101 padlock)	20200S1 G	\$401.60
Cylinder for Schlage S Series Lever	2020097 G	\$401.60

XT Cylinders for TACO

Description	Part Number	Price
Cylinder for Olympus 700 LCM & 800 LCM Key Retaining	20200S1 G	\$401.60

XT Cylinders for Yale

Description	Part Number	Price
Cylinder for Yale 6 pin 5300LN, 5400LN and 4300 Knobs	200503 G	\$399.29

Padlocks

XT padlocks are ideal for access management at off site or hard to reach locations. The robust cylinder with stainless steel components is designed for interior and exterior use. Keys are electronically programmed to open only specific locks during a designated schedule and audit information is recorded in both the lock and key. With no wiring or power supply required, XT padlocks are an ideal application for perimeter fences and gates, or access to equipment storage areas where traditional EAC is practically impossible to install.



The All Weather Padlock (AWP) is recommended for all outdoor applications to provide maximum protection and reliability.

XT Padlocks

Description	Part No.	Price
All Weather Padlock, 5/16" SS shackle, 1-7/8" Clearance	5005511 G	\$606.47
All Weather Padlock, 5/16" SS shackle, 2-3/8" Clearance	5005521 G	\$611.47
All Weather Padlock, 5/16" Boron shackle, 1-7/8" Clearance	5005531 G	\$606.47
All Weather Padlock, 5/16" Boron shackle, 2-3/8" Clearance	5005541 G	\$611.47
All Weather Padlock, 7/16" SS shackle, 2" Clearance	5005711 G	\$606.47
All Weather Padlock, 7/16" SS shackle, 2-1/2" Clearance	5005721 G	\$611.47
All Weather Padlock, 7/16" Boron shackle, 2" Clearance	5005731 G	\$606.47
All Weather Padlock, 7/16" Boron shackle, 2-1/2" Clearance	5005741 G	\$611.47
Hockey Puck Padlock	5292000	\$554.91
SS Indoor/Outdoor Padlock, Non-Key Retaining, 1-1/8" Shackle Clearance, 5/16" Shackle Diameter, w/Cylinder	5451500 G	\$539.41
SS Indoor/Outdoor Padlock, Key Retaining, 1-1/8" Shackle Clearance, 5/16" Shackle Diameter, w/Cylinder	54515R0 G	\$539.41
SS Indoor/Outdoor Padlock, Non-Key Retaining, 2-3/8" Shackle Clearance, 5/16" Shackle Diameter, w/Cylinder	5451F00 G	\$543.41
SS Indoor/Outdoor Padlock, Key Retaining, 2-3/8" Shackle Clearance, 5/16" Shackle Diameter, w/Cylinder	5451FR0 G	\$543.41
SS Shrouded Padlock, Non-Key Retaining, 3/4" Shackle Clearance, 5/16" Shackle Diameter, w/Cylinder	5452500 G	\$567.41
SS Shrouded Padlock, Key Retaining, 3/4" Shackle Clearance, 5/16" Shackle Diameter, w/Cylinder	54525R0 G	\$567.41
SS Indoor/Outdoor Padlock, Non-Key Retaining, 1-3/8" Shackle Clearance, 7/16" Shackle Diameter, w/Cylinder	5471500 G	\$573.41
SS Indoor/Outdoor Padlock, Key Retaining, 1-3/8" Shackle Clearance, 7/16" Shackle Diameter, w/Cylinder	54715R0 G	\$573.41
SS Indoor/Outdoor Padlock, Non-Key Retaining, 1-7/8" Shackle Clearance, 7/16" Shackle Diameter, w/Cylinder	5471F00 G	\$579.41
SS Indoor/Outdoor Padlock, Key Retaining, 1-7/8" Shackle Clearance, 7/16" Shackle Diameter, w/Cylinder	5471FR0 G	\$579.41
SS Shrouded Padlock, Non-Key Retaining, 3/4" Shackle Clearance, 7/16" Shackle Diameter, w/Cylinder	5472500 G	\$622.41
SS Shrouded Padlock, Key Retaining, 3/4" Shackle Clearance, 7/16" Shackle Diameter, w/Cylinder	54725R0 G	\$622.41

Note: In this section, "SS" stands for "System Series."

Medeco XT Padlock Cylinders

Description	Part No.	Price
XT All Weather Padlock Cylinder	510800 G	\$344.89
XT System Series Padlock, Cylinder Only	510600 G	\$438.36
XT Pop-Out Cylinder for G8R Padlock – Round Deadbolt	EV-8501D	\$410.00
XT Pop-Out Cylinder for G8R Padlock – Round Springbolt	EV-8501S	\$410.00
XT Cylinder for Hockey Puck Padlock	2001600 G	\$351.29

Specialty Cylinder Formats

The Medeco® XT Electronic T-handle Cylinders are an ideal for loss and liability management and are available for many specialty applications and formats. Pop-Out Cylinders are available in spring-latch and deadbolt configurations. Stainless steel shell and bolt for lasting strength, durability and strong protection against physical attack. Fits all NAMA Standard T-Handles. Ideal for vending & bottling, bill changers, ATM equipment or other custom OEM applications.



Specialty Cylinder Formats

Description	Part Number	Price
Ruko (outside)	230501S G	\$363.00
Ruko (inside)	230601S G	\$363.00
Snowman (padlock)	230801S G	\$363.00
Mul-T-Lock padlock (G47 Series)	490431 G	\$371.00
XT Insert For Enclosure Lock	EA-100219	\$381.00
Safe Deposit Box Single – Left Hand	490428 G	\$398.74
Safe Deposit Box Single – Right Hand	490429 G	\$398.74

Safe Deposit Box also available in Double.

Pop-Out Cylinders

Description	Part Number	Price
Pop-Out Cylinder Deadbolt assembly, round bolt	EV-8501D	\$410.00
Pop-Out Cylinder, springbolt assembly, round bolt	EV-8501S	\$410.00

Retail/Showcase Locks

Medeco® XT has an electronic cylinder for many types of retail applications. Ideal for loss & liability management with flexible authorization and auditing capabilities. Respond quickly to security threats, lost or stolen keys, or personnel changes without the added cost of changing your locks and keys. The cylinder is powered by the rechargeable key so no wiring or power supply is needed. Medeco XT Plunger Locks are specifically designed for use in wooden or metal sliding doors. Cabinet style locks are also available and along with the plunger locks are ideal applications for security merchandise showcases, metal cabinets, and laboratory and office furniture.



XT Retail/Showcase Locks

Description	Part Number	Price
Cabinet Lock, Latchbolt	490359 G	\$494.00
Cabinet Lock, Deadbolt	490366 G	\$494.00
XT Deadbolt Cabinet Lock, KR	6210555 G XX	\$422.74
XT Deadbolt Cabinet Lock, NKR	6212555 G XX	\$422.74
XT Spring Latch Cabinet Lock	6211555 G XX	\$441.74
XT T Bolt Cam Lock, KR	6280550 G	\$395.74
XT T Bolt Cam Lock, NKR	6282550 G	\$395.74

Cam and Utility Locks

Medeco® XT cam locks are built for strong physical security and offer all the benefits of the XT Electronic Locking System. XT cam locks are available in lengths of 7/8" and 1-1/8" with a wide variety of cams and security collars. The cylinder is designed for interior and exterior use and requires no wiring or modification to the door. Audit information recorded in both the lock and key shows a time-and-date stamped record of every event, including authorized accesses and unauthorized attempts. A quick retrofit to existing hardware, XT cam locks are ideal for utility cabinets, retail fixtures, narcotics storage, safes and more.



XT Cam Locks

Description	Part Number	Price
7/8" Cam lock assembly, Key Retaining	EN-150002-XXX (Op Code)	\$410.00
1-1/8" Cam lock assembly, Key Retaining	EN-150003-XXX (Op Code)	\$410.00

Cam Lock Operation Codes

Description	Op Code
2 flat, 1 keypull, clockwise 90 degree	219
2 flat, 1 keypull, counter-clockwise 90 degree	239
2 flat, 1 keypull, clockwise 180 degrees	259

XT T-bolt Cylinders

Description	Part Number	Price
XT T-bolt – Key Retaining, unlocked at 180 degree	6280550 G -XX	\$395.74
XT T-bolt – Non-Key Retaining, unlocked at 360 degree	6282550 G -XX	\$395.74

XT Cam Lock

Description	Part Number	Price
1 1/8" Cam lock assembly, Non-Key Retaining	600650269 G -XX	\$400.30



XT Switch Locks

Description	Part Number	Price
2 Position, Key Retaining	6522560 G -121-XX	\$379.35
2 Position, Non-Key Retaining	6522560 G -122-XX	\$379.35

Medeco® XT Dual-Tech Cylinder

For Rapid-Entry Applications

The patented Medeco XT Dual-Tech retrofit cylinder is designed for both accountability and rapid-entry applications. It combines two cylinder technologies – the Medeco XT electronic cylinder and the Medeco X4 mechanical cylinder – in one mortise cylinder housing. Both cylinders operate independently of one another so access is provided using either the XT Key or the X4 key.



Allows fire department emergency facility access using a familiar mechanical key while the XT Intelligent key is used for daily accountability. In multi-family applications, tenants use the mechanical key and maintenance uses XT key for accountability. Ideal for any application requiring a mechanical key override.

Medeco Dual Tech Cylinder

Description	Part Number	Price
XT Dual Tech 1-1/4" Mortise Cylinder, with Medeco X4	490423 G	\$632.50
XT Dual Tech 1-1/4" Mortise Cylinder for Arrow/Best	490426 G	\$632.50
XT Dual Tech 1-3/4" Mortise Cylinder	490437 G	\$623.00
XT Dual Tech Rim Cylinder	490432 G	\$927.00

XT Dual-Tech Cams

Dual Tech mortise cylinders come complete with a set of 2 specially designed cams, a direct-drive cam operated by the Medeco XT key and an Override cam operated by the Mechanical key. Cam type must be indicated when ordering (Z00, Z01, etc.)

Important Note: The standard cams listed on pages 83-84 cannot be used in Dual-tech cylinders. Replacement cams must be ordered using the chart below. One each direct drive and override cam required per cylinder.

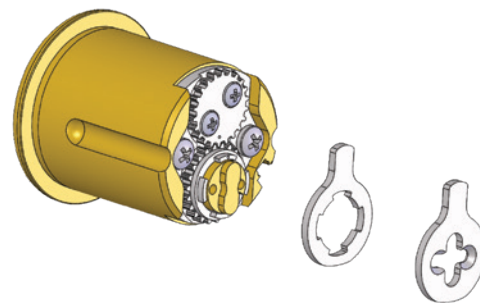

Dual Tech Cams

Description	Part Number	Price
Direct Drive Cam – Russwin	CP-100771-Z00	\$12.10
Override Cam – Russwin Type	CP-100781-Z00	\$12.10
Direct Drive Cam – Yale Type	CP-100771-Z01	\$12.10
Override Cam – Yale Type	CP-100781-Z01	\$12.10
Direct Drive Cam – Adams Rite	CP-100771-Z02	\$12.10
Override Cam – Adams Rite Type	CP-100781-Z02	\$12.10
Direct Drive Cam – Sargent	CP-100771-Z20	\$12.10
Override Cam – Sargent Type	CP-100781-Z20	\$12.10
Direct Drive Cam – Schlage	CP-100771-Z34	\$12.10
Override Cam – Schlage Type	CP-100781-Z34	\$12.10

How to Order a DualTech Cylinder

Technology	Base Part Number	Finish	Keyway	Pinning	Cam
X4	490423G	XX	XX	XX	XX
X4	490437G	XX	XX	XX	XX
X4	490432G	XX	XX	XX	XX
Arrow	490426G	XX	XX	XX	XX

Pinning Options:
 S = Sub Assembled
 P = Pinned
 M = Master Keyed

Medeco XT Traffic Cabinet Lock

The Medeco XT Traffic Cabinet Lock helps to secure our critical infrastructure. The Intelligent Traffic System (ITS) cabinets located at every street corner contain hardware that control our cities streets. Cyber attack is a constant threat. A simple retrofit lock solution like the Medeco XT Traffic Cabinet Lock is the quickest, most cost-effective way to add the accountability necessary to help eliminate tampering with the advanced equipment contained within these cabinets.

Available through specialized resellers only.



Medeco XT Traffic Cabinet Lock:

Description	Part Number	Price
XT Traffic Cabinet Lock – Deadbolt*	EA-100221	\$488.00
XT Traffic Cabinet Lock – Slam bolt*	EA-100220	\$511.00
High Security Mechanical Traffic Cabinet Lock – Deadbolt*	490435	\$242.44
High Security Mechanical Traffic Cabinet Lock – Slam bolt*	490436	\$244.53

* Can be installed in left-hand or right-hand doors.

International Cylinders

The Medeco® XT Modular Half Profile, Euro Double & Thumb Turn electronic cylinders are a direct replacement for like mechanical cylinders and are ideal for loss and liability management. In addition to international uses, many of these cylinders fit imported hardware used in North America. The cylinder requires no wiring or modification to the door or frame and is designed for interior and exterior use.

Attack-resistant design and tamper-proof features provide strong protection against forced entry. Flexible key programming and auditing capabilities allow for quick response to security threats, lost or stolen keys, or personnel changes. Cylinders are widely used at government installations, airports, hotels, universities and schools. Medeco XT is a complete electronic locking system providing controlled access, accountability, physical security, and system management.



XT International Cylinders

Description	Part Number	Price
Lockwood Oval	230301S G	\$336.00
Cylinder Module EURO 1/2 Module – 30mm	232201S 300 G	\$312.52
Cylinder Module EURO 1/2 Module – 35mm	232201S 301 G	\$316.77
Cylinder Module EURO 1/2 Module – 40mm	232201S 302 G	\$321.02
Single/Double cylinder Module EURO 1/2 Module – 30mm	232202S 300 G	\$316.77
Single/Double cylinder Module EURO 1/2 Module – 35mm	232202S 301 G	\$316.77
Single/Double cylinder Module EURO 1/2 Module – 40mm	232202S 302 G	\$321.02
Euro T/T Profile – 30mm/30mm Assembled	23230XS X00 G	\$405.60
Euro T/T Profile – 35mm/35mm Assembled	23230XS X11 G	\$414.10
Modular Profile Cylinder – 30mm Half Profile - Assembled	232301S 800 G	\$363.53
Modular Profile Cylinder – 35mm Half Profile - Assembled	232301S 801 G	\$367.78
Euro 1/2 Profile 30mm Assembled (True 30mm)	232301ST 800 G	\$363.53
Euro Double Profile – 30mm/30mm Assembled	23230E5 X00 G	\$479.08
Euro Double Profile – 35mm/35mm Assembled	23230E5 X11 G	\$487.58

XT Safe Lock

The Medeco XT Safe Lock is a direct replacement for physical security devices that utilize standard mechanical dial combination locks or digital keypad locks. XT Safe Lock includes a reader with key port mounted on the outside of the safe door, and is available three XT lock configurations deadbolt, spring bolt and swing bolt.

To access the safe, an XT Key is programmed via the Medeco XT Web Management Software system to only open a specific XT Safe Lock and the key is issued to a specific user. The user inserts the XT Key into the key port on the exterior reader. Power is supplied by the key to the lock PCB and authentication is initiated with a secure process over the interface communications cable.

An LED provides visual feedback to the user on the current state of the lock. If the lock PCB and XT Key are in agreement that access is granted, the lock PCB will provide power to the internal motor/bolt blocker and the user is allowed to rotate the key to unlock the lock. If the XT Key is not authorized, the user will be prevented from unlocking the safe lock.



XT Safe Lock:

Description	Part Number	Price
XT Safe Lock – Deadbolt Lock Bundle	EA-100206	\$972.00
XT Safe Lock – Spring Bolt Lock Bundle	EA-100207	\$972.00
XT Safe Lock – Swingbolt Lock Bundle	EA-100208	\$972.00

XT Guard Tour Reader

The Medeco XT Guard Tour Reader is a simple, yet powerful, user tracking solution that can be added to any XT Intelligent Key system. The reader mounts easily to any interior or exterior flat surface and programs just like a standard XT cylinder. As the designated 'Tour' individual makes their rounds, they simply touch the reader with their XT key which creates an audit event that proves they completed this task. A record of activity is available for audit or reporting at any time.



XT Guard Tour Reader

Description	Part Number	Price
XT Guard Tour Reader	EA-100240	\$467.00

Medeco® XT Access Interface Module (AIM)

The Medeco® XT Access Interface Module – known as “AIM” – allows the user to insert their Medeco XT key to trigger actions in other systems. Using both authorized and unauthorized event conditions, users can unlock doors with electric strikes or maglocks, initiate video cameras and bring attention to unauthorized events by triggering access control or alarm panels.

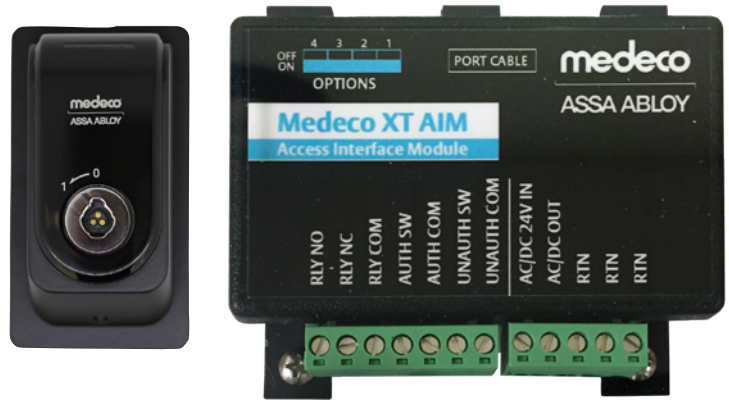

AIM Features:

- Greatly enhances the capability of the Medeco XT Intelligent Key System
- Key audit tracks events just like an XT cylinder
- Two-person authentication option
- Uses NO – Normally Open and NC – Normally Closed relays to trigger different outputs for Access Granted or Access Denied events
- Can be powered by an XT key or 12-24V Power Supply depending on AIM connection

Warranty:

Medeco Security Locks warrants Medeco® XT products to be free of defects in material and/or workmanship for a period of two (2) years from date of original purchase.

Applications:

Medeco XT AIM module can be used with other Access Control or Alarm Panels to trigger authorized and unauthorized event conditions.

Medeco XT Access Interface Module (AIM):

Description	Part Number	Price
Medeco XT Access Interface Module	EA-100192	\$890.00



Medeco Nexgen products are only available through specialized resellers.

Medeco Nexgen

Medeco® Nexgen is a comprehensive loss prevention system incorporating access control, audit capability, physical security, and route management for applications such as parking and vending. In addition to physical protection, the Medeco® Nexgen system gives you the ability to program who gets into your locks and when they get in. The system will also track all activity, including unauthorized attempts to open the lock. These functions are integrated into software that provides key management capability and can be customized to meet your specific requirements. The software provides detailed, flexible reports for complete security management.

All Medeco® Nexgen products have the ability to be linked together throughout your system to provide full integration. One key can be programmed to open any combination of locks.



Nexgen Key



Nexgen Cylinder

Nexgen Locks/Cylinders

Description	Part Number
Nexgen 7/8" Cam Lock, Cale Style	EN-100000
Nexgen 7/8" Cam Lock	EN-100002-219
Nexgen 1-1/8" Cam Lock	EN-100003-219
Retrofit Parking Cylinder, LA/KABA Style	EN-400001
Retrofit Parking Cylinder, Medeco OEM	EN-400002
Retrofit Parking Cylinder, Medeco VLS Replacement	EN-400004
Retrofit Parking Cylinder, Duncan 76	EN-400005
Retrofit Parking Cylinder – POM	EN-400006
Retrofit Parking Cylinder – Parkeon	EN-400007
Nexgen Deadbolt Popout (G8R)	EV-8000D

Nexgen Door/Lock Assemblies

Description	Part Number
Round Door Assembly (short brackets/low capacity)	EP-1210
Round Door Assembly (long brackets/high capacity)	EP-1211

Nexgen Keys

Description	Part Number
Nexgen2 Parking Key-extended nose/Bluetooth	EV-5507

Nexgen Accessories

Description	Part Number
NEW – NexGen2 USB Desktop Programmer w/USB cable	EA-100235
New NexGen2 Multi-key programmer/charger-wall mountable-daisy chain	EA-100200
Same as above no cables	EA-100234
Pogo Pin Kit Collector	94-0171
T-Handle 7/64" Screw Removal	CP-284490
T-Handle 3/32" for Screw Removal	CP-286080
Cleaning Cloth	CP-286170
Brush	CP-286180
Needle Nose Pliers	CP-286190
Deburring Tool	CP-286550
Contact Cleaner Pen	CP-301290
Contact Cleaner Spray	CP-301350
Repl Key Tip Package (extended nose key) & Screws	EA-300071

Nexgen Software

Description	Part Number
NEW-XT Web Parking Software (Medeco Hosted)* CHARGED ANNUALLY	SW-500301-3
NEW-XT Web Parking Software (User Hosted)	SW-600901

Intelligent Key Cabinet (IKC)

The Intelligent Key Cabinet is a complete, electronically-controlled, key management solution that can secure, distribute and audit the use of XT Keys, mechanical keys, or other assets. Only authorized users can gain access to the cabinet via the included biometric fingerprint reader or PIN code pad, or a combination of both. An optional access card reader is also available. IKC is available in configurations to store mechanical keys, XT electronic keys or a combination of both. As an essential addition to any Medeco XT Intelligent Key system, it locks XT keys in place and keeps them charged and ready for use. The IKC can improve employee efficiency and increase accountability which translates into a more secure facility with lower operating costs.



Benefits:

- **Accountability:** No more wondering who has checked out keys or for how long. Complete audit trail and reporting by user and key activity. User accountability reduces lost keys. Fewer lost keys leads to lower expenses and improved security.
- **Analytics:** Identify potential problems in removal and return patterns before they escalate. Complete reporting suite provides multiple reporting options to provide real-time data. Reports can be automatically generated and sent to multiple users by email. Custom reports can be configured and exported to Excel for added convenience.
- **Security:** Loose keys are vulnerable to being misplaced or stolen. Only authorized users are able to access the electronic key management system. Biometric Fingerprint, PIN, and/or Prox Card authentication (optional) allow access to the IKC for added security and control. The IKC supports dual authentication if desired. For added security, a digital photo capture of each login can be added.
- **Convenience:** Allow employees to retrieve keys quickly without waiting for a manager. Quick, easy-to-use web-based or locally hosted software shows what keys are in, what keys are out, and to whom they are issued. The IKC allows the return of any key to any location in the cabinet, and then learns the key's new location.
- **Productivity:** Eliminate time spent searching for, or replacing lost keys – always know who took which key, and when.
- **Efficiency:** Pair with a full XT solution to identify patterns and workflows to gain even greater efficiency and security. XT version cabinets charge and program keys while they are secured and stored, ensuring keys are always ready to go.

Features:

- Heavy-duty enclosure keeps keys safe and secure
- Distributes keys only to authorized users
- Admin notifications (email and SMS) for unreturned keys
- Available in 3 cabinet sizes. Cabinet storage capacities are 32, 64, 96, 128, 160, 192, 224, 256, and 288 (Max capacity for XT version is 64 per cabinet).
- Three versions available: XT, iFob, and Hybrid
- Locks XT keys in place and keeps them charged and ready for use. (XT version)
- Identifies XT key serial number (XT version)
- XT version integrates to XT Web Manager Enterprise
- Built-in 10" touchscreen and fingerprint reader
- Multi-factor verification/authentication includes biometric finger scan, PIN, and Prox Card.
- Audible and visual alarms to indicate trouble conditions
- Built-in camera for photo verification of removal or attempted removal.
- Comprehensive reporting & analytics
- Emergency Fob Release System
- Multi-System Networking
- Medeco high security mechanical lock for manual override
- Options (see page 70 for full list of options):
 - Mounting: Custom Stand - holds 1 or 2 Standard or Mini cabinets to securely hold the cabinets in place without having to mount them on a wall.
 - User authentication: A Multi-class reader is available for purchase or the customer can supply their own reader for installation. (A reader and test card must be provided to Medeco for testing before the cabinet is manufactured to ensure proper compatibility.)

Intelligent Key Cabinet (IKC)

Standard Cabinet

LCD touchscreen used for PIN code authentication, warning messages as well as PC troubleshooting

High security mortise cylinder for manual override

Web-Cam for optional photo verification of access or attempted access

XT Programming Port
Included on XT and Hybrid versions only

Biometric Fingerprint Reader
used for authentication

Add-On Cabinet

High security mortise cylinder for manual override

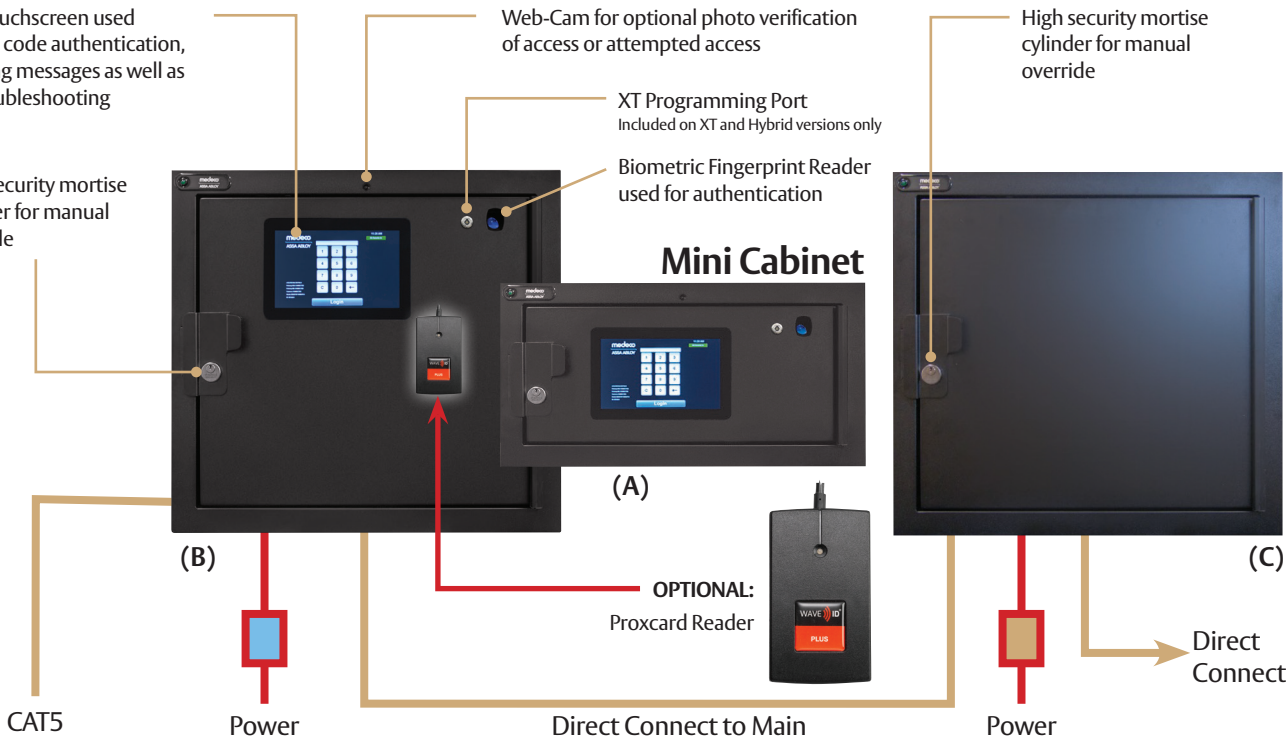

Scalability:

The IKC system can grow as business needs grow by adding on additional secondary cabinets from 32-288 port sizes for iFob units and in a combination of technologies (iFob or XT).

- Each system requires one 'Main' touchscreen cabinet
- Add additional cabinets as needs require
- System can be any combination of 32 or 64 port cabinets
- 32 port cabinets support either XT or iFob ports
- 64 port cabinets support either all XT, all iFob, or a combination of 32 XT plus 32 iFob.
- Main and Secondary boxes can be configured with same technology or different
- Up to 7 Add-on units maximum (512 keys) for every Main unit

Large Cabinet:

- 27" W x 46" H x 11" D
- Weight: 290 pounds
- May require wall reinforcement for mounting
- 160 to 288 key positions
- Available as iFob Main or Add-On Cabinet

Mini Cabinet (Image A):

- Main Cabinet (Image A) 27" W x 14.72" H x 12" D
- Can be stand alone or connected to Add-on cabinet
- Weight: 71 pounds
- Technology – Select All XT or All iFob
- Main and Add-on cabinets can be configured with same technology or different
- 32 key positions

Standard Cabinet (Image B):

- Main Cabinet (Image B), 32 or 64 ports, 27" W x 25.25" H x 12" D
- Weight: 113 pounds
- Can be stand alone or connected to secondary cabinet
- Technology – Select All XT, All iFob, or 32 XT plus 32 iFob
- Main and Add-on cabinets can be configured with same technology or different
- 32-64 key positions – XT/hybrid
- 32-128 key positions – iFob

Add-on Cabinet (Image C):

- Add-on Cabinet (Image C), 27" W x 25.25" H x 12" D
- Available with 32 or 64 ports
- 32 port option expandable to 64 with additional 32 port panel (sold separately)
- Must be connected to a Main cabinet

Intelligent Key Cabinet (IKC)

How to Order:

<p>1</p> <p>EA-100199 Base Part #</p> <p>Refer to pages 68 to 69 for descriptions and technical specifications to find the corresponding base part number.</p>	<p>2</p> <p>M Main Cabinet</p> <p>M = Main Cabinet A = Add On</p>	<p>3</p> <p>D Input Device</p> <p>D = Multi-Class Card Reader 0 = No Input Device*</p> <p>*Note: Input options available on Main cabinet units only.</p>	<p>4</p> <p>1 With Stand</p> <p>0 = No Stand 1 = With Stand</p>
--	---	--	---

EXAMPLE: 32 PORT XT MAIN CABINET, INPUT DEVICE, WITH STAND

EA-100199 - M D 1

Base Number for Intelligent Key Cabinet (IKC)

Base Numbers:

- EA-100199-XXX – 32 port XT Standard
- EA-100236-XXX – 32 port iFob Mini
- EA-100237-XXX – 32 port XT Mini
- EA-100247-XXX – 64 port XT Standard
- EA-100248-XXX – 32 port iFob Standard
- EA-100249-XXX – 64 port iFob Standard
- EA-100250-XXX – 32 XT/32 iFob Combo Standard
- EA-100259-XXX – 96 port iFob Standard
- EA-100260-XXX – 128 port iFob Standard
- EA-100261-XXX – 160 port iFob Large
- EA-100262-XXX – 192 port iFob Large
- EA-100263-XXX – 224 port iFob Large
- EA-100264-XXX – 256 port iFob Large
- EA-100265-XXX – 288 port iFob Large

Stand Options

0 = No Stand
1 = With Stand

External Input Options

D = Multi-class Card Reader
0 = No Input Device*

Cabinet Type (Main or Add-on)

M = Main Cabinet
A = Add On (Note: Add-on cabinets not available in mini size)

Intelligent Key Cabinet



Mini Cabinet



Standard Cabinet



Add-On Cabinet



Large Cabinet

IKC Software Options

Part Number	Description	Price
SW-500141	Medeco-hosted software for IKC, up to 5 cabinets, billed annually	\$1,116.00
SW-500141-1	Self-hosted software for IKC on-site server installations, iFob version only, one-time purchase	\$1,116.00
SW-500141-1R	Annual maintenance fee for IKC self-hosted software, billed annually	\$210.00

Intelligent Key Cabinet

Part Number	Ports	Type (Standard, Mini, Large)	Description	Price
EA-100237-M00	32	XT - Mini	Mini-Cabinet, 32 port XT main, no input, without stand	\$28,571.00
EA-100237-MD0	32	XT - Mini	Mini-Cabinet, 32 port XT main, Multi-class reader input, without stand	\$29,743.00
EA-100237-M01	32	XT - Mini	Mini-Cabinet, 32 port XT main, no input, with stand	\$30,035.00
EA-100237-MD1	32	XT - Mini	Mini-Cabinet, 32 port XT main, Multi-class reader input, with stand	\$31,207.00
EA-100236-M00	32	iFob - Mini	Mini-Cabinet, 32 port iFob main, no input, without stand	\$20,937.00
EA-100236-MD0	32	iFob - Mini	Mini-Cabinet, 32 port iFob main, Multi-class reader input, without stand	\$22,109.00
EA-100236-M01	32	iFob - Mini	Mini-Cabinet, 32 port iFob main, no input, with stand	\$22,401.00
EA-100236-MD1	32	iFob - Mini	Mini-Cabinet, 32 port iFob main, Multi-class reader input, with stand	\$23,573.00
EA-100199-M00	32*	XT - Standard	32 port XT main cabinet, no input, no stand	\$28,571.00
EA-100199-MD0	32*	XT - Standard	32 port XT main cabinet, Multi-class card reader input, no stand	\$29,743.00
EA-100199-M01	32*	XT - Standard	32 port XT main cabinet, no input, with stand	\$30,035.00
EA-100199-MD1	32*	XT - Standard	32 port XT main cabinet, Multi-class card reader input, with stand	\$31,207.00
EA-100199-A00	32*	XT - Standard (add-on)	32 port XT add-on cabinet without stand	\$17,322.00
EA-100199-A01	32*	XT - Standard (add-on)	32 port XT add-on cabinet with stand	\$18,787.00
EA-100247-M00	64	XT - Standard	64 port XT main cabinet, no input, without stand	\$34,486.00
EA-100247-MD0	64	XT - Standard	64 port XT main cabinet, Multi-class card reader input, without stand	\$35,658.00
EA-100247-M01	64	XT - Standard	64 port XT main cabinet, no input, with stand	\$35,950.00
EA-100247-MD1	64	XT - Standard	64 port XT main cabinet, Multi-class card reader input, with stand	\$37,122.00
EA-100247-A00	64	XT - Standard (add-on)	64 port XT add-on cabinet without stand	\$26,373.00
EA-100247-A01	64	XT - Standard (add-on)	64 port XT add-on cabinet with stand	\$27,837.00
EA-100248-M00	32*	iFob - Standard	32 port iFob main cabinet, no input, without stand	\$20,937.00
EA-100248-MD0	32*	iFob - Standard	32 port iFob main cabinet, Multi-class card reader input, without stand	\$22,109.00
EA-100248-M01	32*	iFob - Standard	32 port iFob main cabinet, no input, with stand	\$22,401.00
EA-100248-MD1	32*	iFob - Standard	32 port iFob main cabinet, Multi-class card reader input, with stand	\$23,573.00
EA-100248-A00	32*	iFob - Standard (add-on)	32 port iFob add-on cabinet, without stand	\$14,878.00
EA-100248-A01	32*	iFob - Standard (add-on)	32 port iFob add-on cabinet, with stand	\$16,343.00
EA-100249-M00	64	iFob - Standard	64 port iFob main cabinet, no input, without stand	\$29,158.00
EA-100249-MD0	64	iFob - Standard	64 port iFob main cabinet, Multi-class card reader input, without stand	\$30,330.00
EA-100249-M01	64	iFob - Standard	64 port iFob main cabinet, no input, with stand	\$30,622.00
EA-100249-MD1	64	iFob - Standard	64 port iFob main cabinet, Multi-class card reader input, with stand	\$31,794.00
EA-100249-A00	64	iFob - Standard (add-on)	64 port iFob add-on cabinet, without stand	\$18,659.00
EA-100249-A01	64	iFob - Standard (add-on)	64 port iFob add-on cabinet, with stand	\$20,124.00
EA-100250-M00	32/32 COMBO	XT/iFob - Standard	64 port combo main cabinet, no input, without stand	\$33,097.00
EA-100250-MD0	32/32 COMBO	XT/iFob - Standard	64 port combo main cabinet, Multi-class card reader input, without stand	\$34,269.00
EA-100250-M01	32/32 COMBO	XT/iFob - Standard	64 port combo main cabinet, no input, with stand	\$34,561.00
EA-100250-MD1	32/32 COMBO	XT/iFob - Standard	64 port combo main cabinet, Multi-class card reader input, with stand	\$34,561.00
EA-100250-A00	32/32 COMBO	XT/iFob - Standard (add-on)	64 port combo add-on cabinet, without stand	\$24,984.00
EA-100250-A01	32/32 COMBO	XT/iFob - Standard (add-on)	64 port combo add-on cabinet, with stand	\$26,448.00

* Expandable to 64 total ports with addition of 32 port panel (Sold separately). See page 70 for more details.

Continued on next page.

Intelligent Key Cabinet

Part Number	Ports	Type (Standard, Mini, Large)	Description	Price
EA-100259-M00	96	iFob Standard	96 port iFob standard cabinet, no input, without stand	\$32,000.00
EA-100259-MD0	96	iFob Standard	96 port iFob standard cabinet, Multi-class card reader input, without stand	\$32,750.00
EA-100259-M01	96	iFob Standard	96 port iFob standard cabinet, no input, with stand	\$33,000.00
EA-100259-MD1	96	iFob Standard	96 port iFob standard cabinet, Multi-class card reader input, with stand	\$33,750.00
EA-100259-A00	96	iFob - Standard (add-on)	96 port iFob add-on cabinet, without stand	\$24,856.22
EA-100259-A01	96	iFob - Standard (add-on)	96 port iFob add-on cabinet, with stand	\$25,856.22
EA-100260-M00	128	iFob Standard	128 port iFob standard cabinet, no input, without stand	\$37,760.00
EA-100260-MD0	128	iFob Standard	128 port iFob standard cabinet, Multi-class card reader input, without stand	\$38,510.00
EA-100260-M01	128	iFob Standard	128 port iFob standard cabinet, no input, with stand	\$38,760.00
EA-100260-MD1	128	iFob Standard	128 port iFob standard cabinet, Multi-class card reader input, with stand	\$39,510.00
EA-100260-A00	128	iFob - Standard (add-on)	128 port iFob add-on cabinet, without stand	\$29,880.66
EA-100260-A01	128	iFob - Standard (add-on)	128 port iFob add-on cabinet, with stand	\$30,880.66
EA-100261-M00	160	iFob Large	160 port iFob standard cabinet, no input, without stand	\$43,547.00
EA-100261-MD0	160	iFob Large	160 port iFob standard cabinet, Multi-class card reader input, without stand	\$44,297.00
EA-100261-M01	160	iFob Large	160 port iFob standard cabinet, no input, with stand	\$44,547.00
EA-100261-MD1	160	iFob Large	160 port iFob standard cabinet, Multi-class card reader input, with stand	\$45,297.00
EA-100261-A00	160	iFob - Large (add-on)	160 port iFob add-on cabinet, without stand	\$34,880.34
EA-100261-A01	160	iFob - Large (add-on)	160 port iFob add-on cabinet, with stand	\$35,880.34
EA-100262-M00	192	iFob Large	192 port iFob standard cabinet, no input, without stand	\$49,306.00
EA-100262-MD0	192	iFob Large	192 port iFob standard cabinet, Multi-class card reader input, without stand	\$50,056.00
EA-100262-M01	192	iFob Large	192 port iFob standard cabinet, no input, with stand	\$50,306.00
EA-100262-MD1	192	iFob Large	192 port iFob standard cabinet, Multi-class card reader input, with stand	\$51,056.00
EA-100262-A00	192	iFob - Large (add-on)	192 port iFob add-on cabinet, without stand	\$40,195.56
EA-100262-A01	192	iFob - Large (add-on)	192 port iFob add-on cabinet, with stand	\$41,195.56
EA-100263-M00	224	iFob Large	224 port iFob standard cabinet, no input, without stand	\$55,067.00
EA-100263-MD0	224	iFob Large	224 port iFob standard cabinet, Multi-class card reader input, without stand	\$55,817.00
EA-100263-M01	224	iFob Large	224 port iFob standard cabinet, no input, with stand	\$56,067.00
EA-100263-MD1	224	iFob Large	224 port iFob standard cabinet, Multi-class card reader input, with stand	\$56,817.00
EA-100263-A00	224	iFob - Large (add-on)	224 port iFob add-on cabinet, without stand	\$45,196.70
EA-100263-A01	224	iFob - Large (add-on)	224 port iFob add-on cabinet, with stand	\$46,196.70
EA-100264-M00	256	iFob Large	256 port iFob standard cabinet, no input, without stand	\$60,827.00
EA-100264-MD0	256	iFob Large	256 port iFob standard cabinet, Multi-class card reader input, without stand	\$61,577.00
EA-100264-M01	256	iFob Large	256 port iFob standard cabinet, no input, with stand	\$61,827.00
EA-100264-MD1	256	iFob Large	256 port iFob standard cabinet, Multi-class card reader input, with stand	\$62,577.00
EA-100264-A00	256	iFob - Large (add-on)	256 port iFob add-on cabinet, without stand	\$50,197.50
EA-100264-A01	256	iFob - Large (add-on)	256 port iFob add-on cabinet, with stand	\$51,197.50
EA-100265-M00	288	iFob Large	288 port iFob standard cabinet, no input, without stand	\$66,587.00
EA-100265-MD0	288	iFob Large	288 port iFob standard cabinet, Multi-class card reader input, without stand	\$67,337.00
EA-100265-M01	288	iFob Large	288 port iFob standard cabinet, no input, with stand	\$67,587.00
EA-100265-MD1	288	iFob Large	288 port iFob standard cabinet, Multi-class card reader input, with stand	\$68,337.00
EA-100265-A00	288	iFob - Large (add-on)	288 port iFob add-on cabinet, without stand	\$55,210.12
EA-100265-A01	288	iFob - Large (add-on)	288 port iFob add-on cabinet, with stand	\$56,210.12

Intelligent Key Cabinet Accessories



Cabinet Stand



Cabinet Tray



Medeco iFob



Multi-Class Reader

Description	Part Number	Price
Medeco iFob	EA-300242	\$90.90
6" Cable Seals (price is per cable seal)	EA-300245	\$8.34
Multi-Class reader, includes install and configuration	EA-250066	\$1,387.00
Spare XT Panel	EA-300244	\$9,378.00
Spare iFob Panel	EA-300243	\$7,479.00
Tray Assembly	EA-300257	\$548.00

IKC Installation Items

Description	Part Number	Price
Key Cabinet Stand	EA-300239	\$1,735.00
Large Wallboard	EA-300254	\$457.00
Standard Wall board	EA-300256	\$351.00
Mini Wallboard	EA-300255	\$280.00

IKC Extended Warranty & Service Plan

NEW!

Coverage Includes:	Part Number	Price
<ul style="list-style-type: none"> •Extended Warranty & Service Plan are valid for one year from date of purchase •All cabinet hardware •All software updates and upgrades •Online training •Expedited shipping (replacement parts) •Phone and online support •Pro Service Consultation <p>*Normal use only. Does not cover physical damage or misuse.</p>	SW-500701-1	\$2,756.00

Medeco T21 Key Management System

The Medeco T21 is a sophisticated stand-alone key management system which combines innovative RFID technology and robust design to provide small to medium-sized businesses with the advanced management of 21 keys or keysets in a plug and play solution.



Operation:

- Stand-alone plug & play solution with advanced RFID technology
- Touchscreen interface
- PIN access to designated keys or keysets which are individually locked in place
- Keys are securely attached using special security seals
- Simple to configure through the setup wizard
- No requirement for network connection or PC
- Concealed robust fixing points allow secure wall fixing
- Mains operated with optional battery backup
- 1,000 users per system
- System can save 250,000 audit events

Technical Information:

- User, key and access rights administration
- Multilingual functionality
- Screen-based audit trail and reporting capability or export via USB port
- 21 robust, long-live iFobs with security seals
- 21 locking receptors with LEDs
- Robust and compact steel housing eliminates exposed hinges and obvious access points
- Manual override and door release functions in case of emergency
- Audible alarms

Warranty:

Medeco warrants the T21 to be free of defects in material and/or workmanship for a period of one (1) year from date of original purchase.

iFob

Once attached to an iFob with a robust security seal, individual keys or keysets are assigned to a specific user.

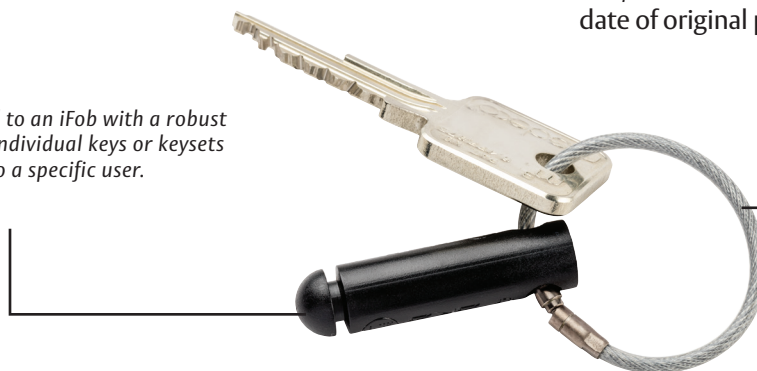

Security Seal

The secure one-time security seal is cost-effective and simple to apply without the need for specific tools.

T21 Key Management System

Description	Part Number	Price
Medeco T21 Key Management System, comes with 21 ifobs and security seals.	EA-100117	\$5,404.00
Security Seal	EA-100148	\$13.10 ea
iFob	EA-100149	\$64.70 ea
Battery	EA-100154	\$151.00
T21 Key override replacement lock	960590 W 26-S6	\$100.87

SimpleK

Master Key System and Key Management Software

SimpleK is a flexible and intuitive software program that streamlines and simplifies the complexities of managing master key systems, keys, and facilities. It combines all tools needed by locksmiths, facility managers, security officers, and anyone else involved in the key management processes.

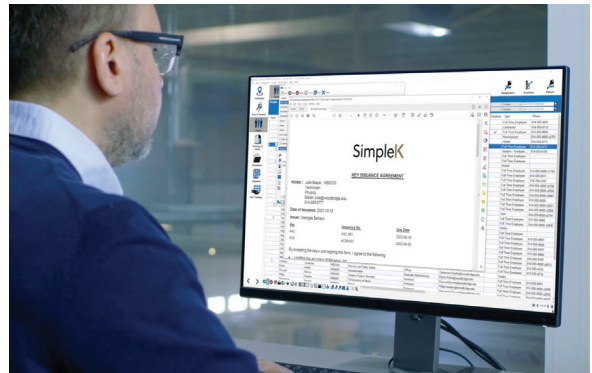

The software provides total key control with audit trails, outstanding keys, overdue keys, tools for the rekeying process, and more. SimpleK software allows you to import maps and floor plans to see who has access to each individual door, the associated keys, and hardware on the opening.

SimpleK allows you to manage keys and keying systems of all sizes and types. This includes: Medeco, Corbin Russwin, ASSA ABLOY ACCENTRA, SARGENT, ASSA, ABLOY, Schlage, Best, and many others.

Features:

- Advanced tools for locksmithing and key control
- Manage all key systems (unlimited number of records)
- Robust import tools to bring current data into SimpleK
- Interactive floor plans
- Master key system design and expansion
- Key requests, approvals, issuances, and returns workflow
- Cylinders and core pinning (verifies key interchange)
- Door-Key association visualization and rekeying solution
- Easily identify keys, access, and hardware on openings
- Visibility to audit trails and outstanding/overdue keys

SimpleK – Standard Edition

Description	Part Number	Price
Primary License (3 users)	SMK040-30	\$3,286.00
Updates & Support Plan on Primary License, 1 year	SMK040-31	\$615.00

SimpleK – Professional Edition

Description	Part Number	Price
Primary License (3 users)	SMK042-30	\$4,383.00
Additional license	SMK042-32	\$579.00
Updates & Support Plan on Primary License, 1 year	SMK042-35	\$956.00
Updates & Support Plan on Additional License, 1 year (per Add. Lic.)	SMK042-33	\$159.00

SimpleK – Enterprise Edition

Description	Part Number	Price
Primary License SimpleK Enterprise Edition	SMK060-30	\$14,647.00
Updates & Support Plan on Primary License, 1 year	SMK060-31	\$1,330.00

Add-On Modules

Description	Part Number	Price
Item Tracking	SMK032-31	\$1,387.00
Web Interface	SMK032-33	\$1,827.00
Room Management	SMK032-35	\$877.00
Mobile Applications	SMK032-37	\$1,242.00

Signature Capture Devices

Description	Part Number	Price
Topaz SigLite 1x5, T-S460-HSB-R	SMK004-01	\$295.00
Topaz SigLite Backlit LCD 1x5, T-LBK460-HSB-R	SMK004-02	\$537.00

*Standard Buying Program Discounts do not apply. Contact Medeco or SimpleK (orders@simplek.com) for net pricing.

Experience a safer
and more open world

medeco
ASSA ABLOY

Technology Overview

Medeco Retrofits More Hardware Than Anyone in the Industry

Medeco 4 (M4)

Ideal for the customer that needs the ultimate in high security protection



- Innovation: movable key element; side and lift pins in the cylinder; triple sidebar control
- Secondary side-pin bittings provide expanded master keying capabilities
- Patented key control protects against unauthorized key duplication
- ANSI/BHMA A156.30 & 156.5 rated — meets or exceeds criteria for strength and durability, key control and surreptitious entry resistance



LARGE

Master Key Capability

Medeco 4 (M4) BiLevel

Cost-effective, patented key control where high security is not necessary



■ UL High Security
■ Patented BiLevel

- BiLevel can tie in with Medeco high-security mechanical products and CLIQ for master keying purposes
- No Special Key Needed: BiLevel cylinders use existing M4 keys for 3D printing prevention, convenience, cost
- BiLevel keys are cut on the same equipment as Medeco 4 and Medeco³ keys
- Reduce costs by using a BiLevel cylinder on doors to bathrooms, copy rooms, and other low risk spaces



SMALL

Master Key Capability

Medeco X4

Patented technology offering SFIC and a variety of formats; great on price and security



- Available in Small Format Interchangeable Core, Large Format Interchangeable Core, and conventional cylinders
- Able to accommodate the majority of commercial hardware and other OEM applications
- Patented Key Control: Legally protected key duplication, help ensure safety and security
- Superior Master Keying with A2 pinning: 65k+ variations and the ability to key different formats

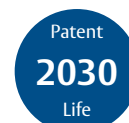

MEDIUM

Master Key Capability

Medeco³

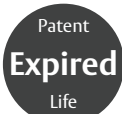

- Triple locking technology for ultimate pick resistance
- Can be masterkeyed into a system containing M3 BiLevel and M3 CLIQ
- Sidebar prevents the key from rotating until the pins are elevated, rotated, and aligned in the correct position

Medeco B (replace Alphabet keyways)



- Medeco B Small Format Interchangeable Cores (SFIC) are an economic and efficient solution to rekeying needs.
- Only available in SFIC
- Available in industry standard alphabet keyways + W Series
- Medeco B retrofits existing systems, significantly reducing installation time
- Available in standard 6 and 7 pin format in established keyways
- No contract is required to provide Medeco B

Medeco 4

High Security Locking System

Medeco builds on more than 50 years of lock engineering innovation and takes security to the next level, offering the highest level of protection against physical attack and unauthorized key duplication with Medeco 4 (M4).

M4 cylinders are UL 437 listed for physical strength and high security components, using solid brass construction with strategically placed hardened-steel inserts to thwart drilling attacks. In addition to tumbler pins that lift and rotate, M4's design includes up to 4 side pins: 3 finger pins and 1 lift pin, which must all interact with the sidebar to open, providing a high level of pick resistance. The patent-pending M4 key design, with its shuttle pin movable element, also protects against the emerging threat of 3D printing for added credential security.



Key Control

Patent-pending key control protects against unauthorized duplication of keys (M4's patent runs through 2040).



Protection Against 3D Printing

A patent-pending movable element in the key deters against unauthorized 3D printed copies of keys or blanks.



Picking and Bumping Protection

M4 cylinders use cylinder side pins, a shuttle lift pin and a movable key element to engage a sidebar that prevents the key from turning until the elements are rotated and aligned in the correct position, protecting against bumping, picking and other attacks.



Uses Existing Hardware

M4 cylinders are available in a wide variety of formats, retrofitting most hardware on the market.



Protection From Physical Attack

M4 cylinders are UL 437 listed and UL test lab proven to stand up to drilling, picking and other forms of physical attack.



Special Angled Cut Keys

A special key cutting machine and access to Medeco-specific blanks are required to duplicate M4 keys, which are available in multiple levels of restriction to support every need.



Master Keying Capabilities

M4 cylinders can be master keyed into a system that includes M4 and M4 BiLevel keys and cylinders. Extremely large systems are possible.

Technical Information

Cylinders:

- **UL 437:** – Underwriters Laboratory Standard for a locking cylinder's ability to resist physical attack.
- **ANSI/BHMA A156.30 & 156.5 rated** – meets or exceeds criteria for strength and durability, key control, and surreptitious entry resistance.
- Solid brass machined construction
- Uses Biaxial high-security pins
- 100,000 cycle endurance tested

Keys:

- Angled, offset cuts on key blade
- Movable element on blade provides 3D key and key blank copy protection
- Patent-pending protection against duplicate keys
- Unique keyway pre-cuts using side cuts
- Secondary biting/side pins in four positions
- Expanded master keying capability

Applications:

- M4 cylinders are available in a wide variety of formats and are ideal for any application requiring key control and a high level of physical security.

Warranty:

M4 cylinders are warranted for two years against manufacturer's defects. M4 keys have a lifetime warranty against breakage. See the Medeco limited warranty for details.

Medeco BiLevel

Medeco 4 BiLevel cylinders offer affordable key control through patent-pending protected keys. Standard locking systems without utility patent protected keys allow anyone who gains possession of a key to easily and inexpensively make a copy. With an unauthorized duplicate key, a thief has complete access to a building, its physical and intellectual property, and the people inside. BiLevel locking systems ensure that the keys to a facility can only be duplicated by certified Medeco dealers and only with the proper authorization.

Medeco BiLevel cylinders can tie in with other Medeco mechanical and Intelligent Key products for master keying purposes.



Patented -pending Key Control

Protects against unauthorized duplication of keys.



Special Angle Cut Keys

Requires a special key cutting machine and access to Medeco specific blanks, available in a variety of restrictions to support every need.



Uses Existing Hardware

Medeco offers the largest selection of retrofit cylinders that reduce cost by eliminating the need to replace your existing hardware.



Can Be Master Keyed

Can be master keyed into a system containing M4 BiLevel and M4 mechanical.

Technical Information:

- Keyed with Medeco 4 high security systems or as its own standalone system

Applications:

BiLevel retrofit cylinders are ideal for any application requiring patented key control where physical high security is not necessary.

Warranty:

Medeco BiLevel cylinders are warranted for two years against manufacturer's defects. See the Medeco limited warranty for full details.

Cylinder Formats:

- Rim & Mortise
- Key in Knob/Lever Cylinders
- Large Format Interchangeable Cores
- Padlocks
- Deadbolts

Medeco X4

All facilities need patented key control to effectively secure exterior and interior openings. This strength of integrity allows security managers to have peace of mind when it comes to managing the system. Unfortunately, instituting a new key system is not always easy... or economical.

Medeco X4 is an economic and efficient solution to rekeying needs. Medeco X4 has one of the largest master key capabilities on the market, allowing facility managers to tie everything together under one key for ease, convenience and efficiency. Additionally, Medeco X4 easily retrofits into existing systems, significantly reducing installation time.

Medeco X4 is the perfect security upgrade for small format interchangeable core (SFIC) installations. In addition to SFIC cylinders, Medeco X4 is also available in many retrofit cylinder formats that can all be keyed into a single system.



Patented Key Control

Protects against unauthorized duplication of your keys.



Uses Existing Hardware

Medeco X4 is available in a large selection of retrofit cylinder formats that can all be keyed into a single system.



Quickly Change Cores

Medeco X4 SFIC cylinder provides quick and easy cylinder changes in the event keys are lost or stolen.



Can be Master Keyed

Available in Small Format Interchangeable Cores (SFIC) and other retrofit cylinder formats which can be master keyed together, eliminating the need to replace your existing hardware.

Technical Information:

- Superior master key capabilities, up to four (4) times that of similar style cylinders
- One key flexibility for different cylinder styles compatible
- Patented system lasting until the year 2030
- Custom key coining for added security

Applications:

The Medeco X4 retrofit cylinders are ideal for any application requiring key control and physical security of your cylinders

Warranty:

Medeco X4 cylinders are warranted for two years against manufacturer's defects. See the Medeco® limited warranty for full details

Cylinder Formats:

- Rim & Mortise
- Key in Knob/Lever Cylinders
- Small Format Interchangeable Cores
- Large Format Interchangeable Cores
- Padlocks
- Deadbolts



Medeco B

Medeco B Small Format Interchangeable Cores (SFIC) provide quick and easy cylinder changes in the event keys are lost or stolen. Medeco B is an economic and efficient solution to rekeying needs. Medeco B easily retrofits into existing systems, significantly reducing installation time.

Medeco B offers flexibility and is available in standard 6 and 7 pin format in established competitive keyways. The reinforced sleeve design provides added strength and durability.



Competitive Keyways

Medeco B is an affordable alternative for end users currently using industry standard unpatented keyways. Available keyways: 1C, 1D, AB, BB, CB, DB, EB, FB, GB, HB, JB, KB, LB, MB, QB, RB, TA, TB, TC, TD, TE, WA, WB, WC, WG, WH & WY.



Quickly Change Cores

Medeco B SFIC cylinder provides quick and easy cylinder changes in the event keys are lost or stolen.



Fits Existing & New Master Key Systems

Medeco B is priced to save clients' money vs. other unpatented competitors and can be substituted directly into existing SFIC master key systems.

Applications:

The Medeco B retrofit cylinders are ideal for any application requiring unpatented key control that can be substituted directly into existing small format interchangeable core systems.

Warranty:

Medeco B cylinders are warranted for two years against manufacturer's defects. See the Medeco® limited warranty for full details.

Finishes:

- Available in all standard finishes to match existing hardware.

Technical Information:

- Solid brass construction
- Reinforced sleeve design
- Uses A2 SFIC Specifications
- Available with Medeco-branded stamping or no stamping
- 6 & 7 pin unpatented SFIC
- Sleeve, shell, plug & face plate made of brass
- Individually capped pin chambers
- Available in the following industry standard SFIC keyways: 1C, 1D, AB, BB, CB, DB, EB, FB, GB, HB, JB, KB, LB, MB, QB, RB, TA, TB, TC, TD, TE, WA, WB, WC, WG, WH & WY
- Dealers do not need a contract to purchase Medeco B SFIC Cores. Cores are available through Medeco and authorized distributors.

Product Overview

The Most Extensive Line of Commercial Retrofit Products

Rim and Mortise



Medeco mortise cylinders are precision-machined solid brass and retrofit into virtually any industry standard hardware.

Key in Knob/Lever



Medeco Key-in-Knob/Lever cylinders are designed to retrofit cylindrical locksets, lever-type cylindrical locksets, padlocks, and bored-type auxiliary deadlatches and deadlocks.

Interchangeable Core



Medeco Small Format and Large Format Interchangeable Cores are specifically manufactured to retrofit the vast majority of competitive cylinders, without replacing expensive door hardware.

Deadbolts



The Medeco Maxum Deadbolt routinely receives top billing in Consumer Reports as the strongest deadbolt across all of its lock categories. The Maxum Deadbolt is a beast!

Padlocks



Medeco offers a variety of padlocks, including those with patent protection and UL-listed technologies.

Cam Locks



Medeco cam locks are recognized throughout the world as the standard for protection in a 3/4 inch diameter lock.

Specialty



From parking locks to locks for vending machines, Medeco manufactures locks for virtually every application: cabinet locks, switch locks, traffic cabinet locks, vending machine locks, banking locks, and more.

International

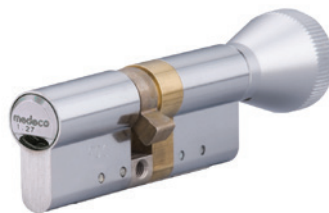

Medeco's international cylinders are designed to fit in locksets of major world manufacturers. In addition to international uses, many of these cylinders fit imported hardware used in North America.

Accessories



Supplement your Medeco products with extra pins, keyblanks, tailpieces, etc. Reference this section when you need replacement screws, springs, pin hole covers, and Medeco-approved key machines.

Rim & Mortise Cylinders

Medeco mortise cylinders are precision-machined solid brass and retrofit into virtually any industry standard hardware. Rim cylinders can be used with auxiliary locking devices such as: surface mounted deadbolts, night latches, panic devices and jimmy proof locks (also known as vertical dropbolts or interlocking deadbolts). Medeco high security rim and mortise cylinders are UL 437 listed for drill and pick resistance, and the those that incorporate the Medeco 4 (M4), M4 BiLevel, or Medeco X4 technologies, offer utility patented key control.



Patented Key Control

Protects against unauthorized duplication of keys.



Picking and Bumping Protection

M4 cylinders use cylinder side pins, a lift pin and a movable key element to engage a sidebar that prevents the key from turning until the elements are rotated and aligned in the correct position, protecting against bumping, picking and other attacks.



Protection From Physical Attack

M4 rim & mortise cylinders are UL 437 listed and stand up to drilling, picking and other forms of physical attack.



Special Angle Cut Keys

Requires a special key cutting machine and access to Medeco specific blanks, available in multiple levels of restriction to support every need.



Uses Existing Hardware

Medeco offers the largest selection of retrofit Rim & Mortise cylinders that reduce cost by eliminating the need to replace existing hardware.



Master Keying Capabilities

M4 can be master keyed into a system containing M4 BiLevel. Extremely large systems are possible.

Applications

Flexible options designed to retrofit various manufacturers mortise and rim locks

Warranty:

Warranted for two (2) years against manufacturers' defects. See the Medeco® limited warranty for full details

Technical Features:

- ANSI/BHMA A156.30 Certification assures patent protected key control and physical strength (M4)
- ANSI/BHMA A156.5 Grade 1 Certification assures consistent quality for heavy use applications (M4)
- Solid brass construction provides high quality and long cylinder life
- Set screw pin chamber caps allow quick and easy pinning and re-keying without the need to take the cylinder apart
- Large variety of cylinder lengths and cam/tailpiece configurations provide excellent retrofit capability and reduce the need to replace the entire locking device

Finishes:

- Available in all standard finishes to match existing hardware

Available Key Technologies:

Mechanical:

- M4/M4 BiLevel
- M³/M³ BiLevel
- X4

Intelligent Key:

- M³ CLIQ
- Classic CLIQ
- X4 CLIQ
- XT

How To Order Rim & Mortise Cylinders

Complete part numbers are required for all orders. To determine the correct part number, fill in the "X's" in sequential order.

1

100200 base part # example

Refer to pages 81-87 for descriptions and technical specifications to find the corresponding base part number.

2

H technology

H = M4
P = M4 BiLevel
T = M³
J = M³ BiLevel
S = M³ CLIQ
W = Biaxial
- = Original
K = KM
C = Classic CLIQ
N = X4
M = X4 CLIQ
G = XT

3

05 finish

Refer to the inside back cover of this catalog for finish options.

4

M4 keyway

Insert keyway if known or contact Customer Service for help.

5

P pinning

S = Sub-Assembled (Uncombined)
N = Sub-assembled,
– No side pins (M4 only)
– No slider (M3 only)
P = Pinned (Combined)
M = Master Keyed
R = Master Keyed
– blade and side pins (Medeco 4 only)

6

Z01 cam or tailpiece

Refer to pages 83-84 for cam and tailpiece options.
If not specified, Z01 for mortise and Y02 for rim will be supplied.

7

624 side pin code

(M4 only)

Insert side pin code if known or contact Customer Service for help.

BUILD A RIM & MORTISE PART #:

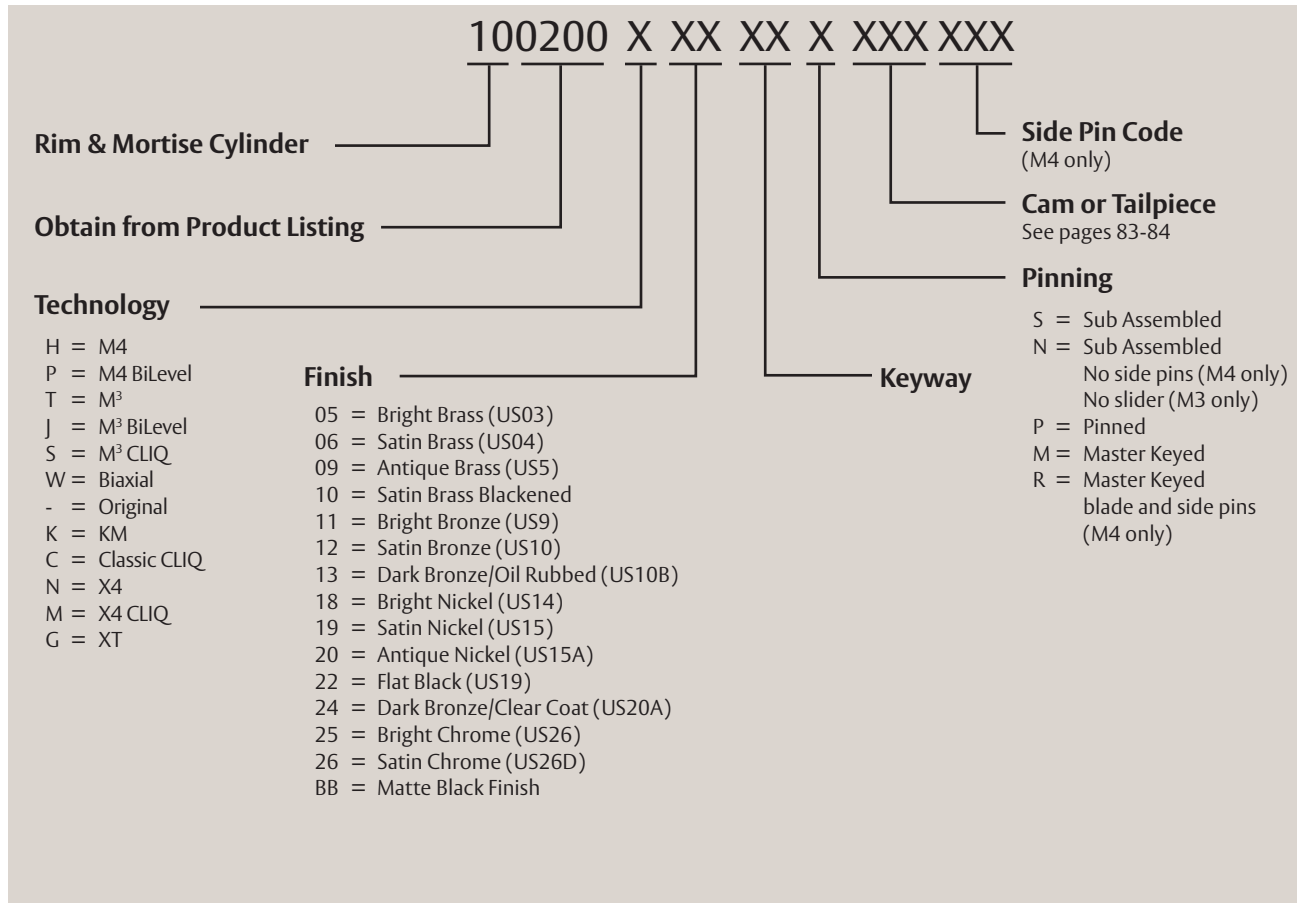

For legacy technology pricing, call Customer Service or visit Medeco.com.

Standard Mortise Cylinders

Description	Part Number	M4	M4 BiLevel	M3	M3 BiLevel	X4
1" 5 Pin Mortise Cylinder – (6 pin for Medeco X4)	100100 (P)	\$186.50	\$101.65	\$194.15	\$105.47	\$127.23
	100100 (S)	\$170.00	\$92.65	\$177.65	\$96.47	\$110.73
1" 5 Pin Mortise Cylinder with 120° notch along top of shell for alternate retaining location	100101 (P)	\$186.50	\$101.65	\$194.15	\$105.47	
	100101 (S)	\$170.00	\$92.65	\$177.65	\$96.47	
1-1/8" 6 Pin Mortise Cylinder	100200 (P)	\$186.50	\$101.65	\$194.15	\$105.47	\$127.23
	100200 (S)	\$170.00	\$92.65	\$177.65	\$96.47	\$110.73
1-1/4" 6 Pin Mortise Cylinder	100500 (P)	\$194.50	\$106.01	\$202.51	\$110.02	\$130.00
	100500 (S)	\$178.00	\$97.01	\$186.01	\$101.02	\$113.50
1-3/8" 6 Pin Mortise Cylinder	105100 (P)	\$201.50	\$109.83	\$209.82	\$113.99	\$142.87
	105100 (S)	\$185.00	\$100.83	\$193.32	\$104.99	\$126.37
1-1/2" 6 Pin Mortise Cylinder	105200 (P)	\$273.50	\$149.06	\$285.06	\$154.85	\$193.91
	105200 (S)	\$257.00	\$140.06	\$268.56	\$145.85	\$177.41
1-5/8" 6 Pin Mortise Cylinder	105300 (P)	\$280.50	\$152.88	\$292.38	\$158.82	\$200.91
	105300 (S)	\$264.00	\$143.88	\$275.88	\$149.82	\$184.41
1-3/4" 6 Pin Mortise Cylinder	105400 (P)	\$287.50	\$156.69	\$299.69	\$162.79	\$207.91
	105400 (S)	\$271.00	\$147.69	\$283.19	\$153.79	\$191.41
2" 6 Pin Mortise Cylinder	105500 (P)	\$304.50	\$165.96	\$317.46	\$172.44	\$224.91
	105500 (S)	\$288.00	\$156.96	\$300.96	\$163.44	\$208.41
2-1/4" 6 Pin Mortise Cylinder	105600 (P)	\$319.50	\$174.13	\$333.13	\$180.95	
	105600 (S)	\$303.00	\$165.13	\$316.63	\$171.95	
2-1/2" 6 Pin Mortise Cylinder	105700 (P)	\$338.50	\$184.49	\$352.99	\$191.74	\$258.91
	105700 (S)	\$322.00	\$175.49	\$336.49	\$182.74	\$242.41
2-3/8" 6 Pin Mortise Cylinder	105904 (P)	\$327.50		\$341.50		
	105904 (S)	\$311.00		\$325.00		
2-3/4" 6 Pin Mortise Cylinder	105104 (P)	\$356.50		\$371.80		
	105104 (S)	\$340.00		\$355.30		
3-1/4" 6 Pin Mortise Cylinder	105900 (P)	\$386.50		\$403.15		\$386.50
	105900 (S)	\$370.00		\$386.65		\$370.00
4-1/8" 6 Pin Mortise Cylinder	105800 (P)	\$441.50		\$460.63		
	105800 (S)	\$425.00		\$444.13		
5" 6 Pin Mortise Cylinder	105901 (P)	\$495.50		\$517.05		
	105901 (S)	\$479.00		\$500.56		

Jumbo/Mogul Mortise Cylinders

Description	Part Number	M4	M4 BiLevel	M3	M3 BiLevel	X4
6 Pin Jumbo Mortise Cylinder (1-19/64" Long, 1-3/8" Shell Dia.) Corbin Russwin® Master Ring Cylinder Replacement	101350 (P)	\$243.50	\$132.72	\$253.72	\$137.82	\$192.54
	101350 (S)	\$227.00	\$123.72	\$237.22	\$128.82	\$176.04
6 Pin 1-1/4" Mogul Cylinder for Prison Locks (1-1/4" Long, 2" Shell Dia.)	104001 (P)	\$254.50		\$265.21		
	104001 (S)	\$238.00		\$248.71		

(P) = Pinned (combined)

(S) = Sub-assembled (uncombined)

Surcharges for Master Keying, Custom Coining and Custom Stamping apply, see page 196.
Refer to the XT and CLIQ Intelligent Key sections for format availability and pricing.

Limited Rotation Mortise Cylinders

Description	Part Number	M4	M4 BiLevel	M3	M3 BiLevel	X4
6 Pin 1-1/4" Mortise Cylinder with Raised Plug, Limited Rotation: CK 145° CW and 145° CCW	100500H (P)	\$244.06		\$252.07		
	100500H (S)	\$227.56		\$235.57		
6 Pin 1-1/4" Mortise Cylinder Hotel Function, Uses Spring Loaded Stop Pins with Notched and Un-Notched Keys to Provide Directional and Limited Rotation	100501 (P)	\$231.50		\$241.18		
	100501 (S)	\$215.00		\$224.68		
6 Pin 1-3/16" Length Mortise Cylinder Limited Rotation: CK 145° CCW, MK 360° CCW and CW	490078 (P)	\$212.50		\$221.32		
	490078 (S)	\$196.00		\$204.82		
6 Pin 1-3/16" Length Mortise Cylinder, Limited Rotation: CK 145° CW, MK 360° CCW and CW	490079 (P)	\$212.50		\$221.32		
	490079 (S)	\$196.00		\$204.82		

Specialty Mortise Cylinders

Description	Part Number	M4	M4 BiLevel	M3	M3 BiLevel	X4
5 Pin Otis® Elevator Mortise Cylinder, 1 Key Pull Position	100903 (P)	\$207.50		\$216.09		
	100903 (S)	\$191.00		\$199.59		
5 Pin Otis® Elevator Mortise Cylinder, 2 Key Pull Positions (not used in MK systems)	100909 (P)	\$236.50		\$246.40		
	100909 (S)	\$220.00		\$229.90		
1-7/32" 6 Pin Mortise Cylinder with Mini Micro Switch, 7 Amp, SPDT, 1 Key Pull (requires quick connect leads: CP-270511)	100200A (P)	\$298.90	\$214.05	\$306.55	\$217.88	\$210.50
	100200A (S)	\$282.40	\$205.05	\$290.05	\$208.88	\$194.00
1-1/8" 6 Pin Concealed Face Mortise Cylinder for Schlage® "K" Locks, Trim Style 712, 714, 202	100202 (P)	\$212.50	\$115.82	\$221.32	\$120.23	\$151.82
	100202 (S)	\$196.00	\$106.82	\$204.82	\$111.23	\$135.32
1-1/8" 6 Pin Mortise Cylinder with Extended Plug & Second Cam Washer Reversed to Close Bottom of Keyway	104207 (P)	\$226.50	\$109.83	\$234.82	\$113.99	
	104207 (S)	\$185.00	\$100.83	\$193.32	\$104.99	
1-1/8" 6 Pin Mortise Cylinder with Extended Plug	104207A (P)	\$201.50	\$109.83	\$209.82	\$113.99	
	104207A (S)	\$185.00	\$100.83	\$193.32	\$104.99	
6 Pin LFIC Mortise Cylinder with 15 Amp Micro Switch	320200B (P)	\$457.85		\$471.17		
	320200B (S)	\$441.35		\$454.67		
1 1/4" 6 Pin Mortise Cylinder for VingCard® Persona®	490214 (P)	\$194.50	\$106.01	\$202.51	\$110.02	
	490214 (S)	\$178.00	\$97.01	\$186.01	\$101.02	

Mortise Cylinder Plugs

Description	Part Number	Price
Plug for 10T0200 (Medeco ^{3®})	1200500 T	\$75.66
Plug for 10T0500 (Medeco ^{3®})	1202000 T	\$75.66
Plug for 10T0100 (Medeco ^{3®})	1202100 T	\$75.66
Plug for 10J0500 (Medeco ³ BiLevel®)	1239000 J	\$74.03
Plug for 10J0100 (Medeco ³ BiLevel®)	1239100 J	\$74.03
Plug for 10J0200 (Medeco ³ BiLevel®)	1251300 J	\$74.03
Plug for 10H0200 (Medeco 4)	12801006	\$72.40
Plug for 10H0500 (Medeco 4)	12828006	\$72.40
Plug for 10H0100 (Medeco 4)	12829006	\$72.40

















Include finish and keyway with all part #'s. Medeco³ or Medeco BiLevel Slider package sold separately.

(P) = Pinned (combined)

(S) = Sub-assembled (uncombined)

Surcharges for Master Keying, Custom Coining and Custom Stamping apply, see page 196. Refer to the XT and CLIQ Intelligent Key sections for format availability and pricing.

Mortise Cams













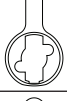

Description	Part Number	Price
 Corbin Russwin® Type	CT-Z00	\$5.46
 Standard Yale® Type	CT-Z01	\$5.46
 Adams Rite® Type	CT-Z02	\$5.46
 Keil® Norwalk Type	CT-Z04	\$5.46
 Schlage® Type	CT-Z05	\$5.46
 Medium Yale® Type	CT-Z06	\$5.46
 Segal® Type	CT-Z07	\$5.46
 Lockwood® Type	CT-Z08	\$5.46
 Corbin Russwin® Type	CT-Z09	\$5.46
 Segal® Deadbolt Type	CT-Z16	\$5.46
 Corbin Russwin® Oversized Jumbo	CT-Z17	\$5.46
 For Night Deposit Lock	CT-Z18	\$5.46
 General® Lock	CT-Z19	\$5.46
 Sargent® Type	CT-Z20	\$5.46
 Ruko® Type	CT-Z21	\$5.46
 Falcon® Type	CT-Z22	\$5.46

(P) = Pinned (combined)

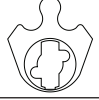
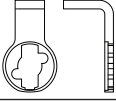
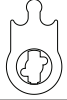
(S) = Sub-assembled (uncombined)

Surcharges for Master Keying, Custom Coining and Custom Stamping apply, see page 196.
Refer to the XT and CLIQ Intelligent Key sections for format availability and pricing.

Mortise Cams

Description	Part Number	Price
 Schlage® Type	CT-Z34	\$5.46
 Mogul Lock	CT-Z45	\$5.46
 Yale® Mortise After 1982	CT-Z47	\$5.46
 Dominion®	CT-Z48	\$5.46
 Corbin Russwin® Jumbo	CT-Z55	\$5.46
 Yale® Medium After 1982	CT-Z56	\$5.46
 Medeco Residential	CT-Z57	\$5.46
 Falcon® Type	CT-Z58	\$5.46
 Corbin Russwin® Master Ring clover leaf for deadbolt function locks made since 6/93	CT-Z59	\$5.46
 Hook Type for Detention Locks	CT-Z61	\$6.42
 Mogul clover leaf	CT-Z69	\$15.30
 Best® Hotel Function Reversible Lock	CT-Z70	\$5.46
 Marks® J Type	CT-Z84	\$5.46
 VingCard® Persona®	CT-Z87	\$5.46
 Falcon® Type	CT-Z99	\$5.46
 Sargent Mogul	CT-ZA6	\$4.98

(P) = Pinned (combined)

(S) = Sub-assembled (uncombined)

Surcharges for Master Keying, Custom Coining and Custom Stamping apply, see page 196.
Refer to the XT and CLIQ Intelligent Key sections for format availability and pricing.

Mortise Components

Description	Part Number	Price
1-1/2" Dia. Threaded Adapter Ring for Corbin® Jumbo Mortise Cylinder (converts conventional size Mortise Cylinder to Jumbo thread size) Contains: CP-050131 Adapter Ring and CP-011013-030 # 8-32 x 3/16" Set Screws	94-0010	\$63.90
M ³ Slider Package, Includes Slider & Spring	94-0174-XX	\$16.20
Cam Washer for Mortise Cylinders	CP-021011	\$0.96
Mounting Nut for Mortise Cylinder 1.150"-32 UNS Inside Dia.	CP-050120	\$14.50
5 Pin Sidebar Assembly, .123" high for Door Hardware Cylinders	CP-084571	\$9.83
6 Pin Sidebar Assembly, .123" high for Door Hardware Cylinders	CP-084671	\$9.83

Mortise Components (Sold in Packs)

Description	Part Number	Pack Size	Price
# 2-56 UNC x 5/16" Length Phillips® Head Screws- Stainless Steel (used to attach cams to Mortise Cylinders) (Pack of 100)	CP-010203-050	100	\$30.00
Set Screws (for Medeco X4 pin chamber) # 6-32 x 1/8" (Pack of 100)	CP-011011-020	100	\$31.00
Set Screws (for High Security pin chambers) #8-32 x 1/8" (Pack of 100)	CP-011013-020	100	\$37.00
Sidebar Spring-Stainless Steel (pack of 100)	CP-030018	100	\$11.00

Rim Cylinders

Description	Part Number	M4	M4 BiLevel	M3	M3 BiLevel	X4
5 Pin 1-1/16" Rim Cylinder - Horizontal Tailpiece	100300H (P)	\$192.50	\$104.92	\$200.42	\$108.88	\$139.11
	100300H (S)	\$176.00	\$95.92	\$183.92	\$99.88	\$122.61
5 Pin 1-1/16" Rim Cylinder - Vertical Tailpiece	100300V (P)	\$192.50	\$104.92	\$200.42	\$108.88	\$139.11
	100300V (S)	\$176.00	\$95.92	\$183.92	\$99.88	\$122.61
5 Pin 1-1/16" Rim Cylinder, Sargent® Mounting Style, Horizontal Tailpiece	100305H (P)	\$192.50	\$104.92	\$200.42	\$108.88	
	100305H (S)	\$176.00	\$95.92	\$183.92	\$99.88	
5 Pin 1-1/16" Rim Cylinder, Sargent® Mounting Style, Vertical Tailpiece	100305V (P)	\$192.50	\$104.92	\$200.42	\$108.88	
	100305V (S)	\$176.00	\$95.92	\$183.92	\$99.88	
5 Pin 1-1/16" Rim Cylinder, 180 Degree Lazy Motion	100600 (P)	\$203.50	\$110.92	\$211.91	\$115.12	
	100600 (S)	\$187.00	\$101.92	\$195.41	\$106.12	
6 Pin, 1-1/8" Rim Cylinder Horizontal Tailpiece	100400H (P)	\$203.50	\$110.92	\$211.91	\$115.12	\$137.32
	100400H (S)	\$187.00	\$101.92	\$195.41	\$106.12	\$120.82
6 Pin, 1-1/8" Rim Cylinder Vertical Tailpiece	100400V (P)	\$203.50	\$110.92	\$211.91	\$115.12	\$137.32
	100400V (S)	\$187.00	\$101.92	\$195.41	\$106.12	\$120.82
6 Pin 1-1/8" Rim Cylinder- Sargent® Mounting Style, Horizontal Tailpiece	100403H (P)	\$203.50	\$110.92	\$211.91	\$115.12	\$137.32
	100403H (S)	\$187.00	\$101.92	\$195.41	\$106.12	\$120.82
6 Pin 1-1/8" Rim Cylinder- Sargent® Mounting Style, Vertical Tailpiece	100403V (P)	\$203.50	\$110.92	\$211.91	\$115.12	\$137.32
	100403V (S)	\$187.00	\$101.92	\$195.41	\$106.12	\$120.82
6 Pin 1-1/8" Rim Cylinder, 180 Degree Lazy Motion	100700 (P)	\$203.50	\$110.92	\$211.91	\$115.12	\$137.32
	100700 (S)	\$187.00	\$101.92	\$195.41	\$106.12	\$120.82
6 Pin Jumbo Rim Cylinder Corbin Russwin® Master Ring Cylinder Replacement	101355 (P)	\$258.50		\$269.39		
	101355 (S)	\$242.00		\$252.89		

6 Pin high security cylinders are available in 7 Pin in Medeco X4.

(P) = Pinned (combined)

(S) = Sub-assembled (uncombined)

Surcharges for Master Keying, Custom Coining and Custom Stamping apply, see page 196.
Refer to the XT and CLIQ Intelligent Key sections for format availability and pricing.

Rim Cylinder Plugs

Description	Part Number	Price
Plug for 10T0300 (Medeco ^{3®})	1200100 T	\$75.66
Plug for 10T0400 (Medeco ^{3®})	1203000 T	\$75.66
Plug for 10J0300 (M ³ BiLevel [®])	1238900 J	\$74.03
Plug for 10J0400 (M ³ BiLevel [®])	1251200 J	\$74.03
Plug for 10H0300 (Medeco 4)	12847006	\$72.40
Plug for 10P0300 (M4 BiLevel)	1238900P	\$73.12
Plug for 10H0400 (Medeco 4)	12814006	\$72.40
Plug for 10P0400 (M4 BiLevel)	1251200P	\$73.12

Add finish and keyway to all part #'s .

M³ or Medeco BiLevel Slider package sold separately .

Rim Components







Description	Part Number	Price
M ³ Slider Package, Includes Slider & Spring	94-0174-XX	\$16.20
Set Screws (for Medeco X4 pin chamber) #6-32 x 1/8"	CP-011011-020	\$0.31
Set Screws (for HS pin chambers) #8-32 x 1/8"	CP-011013-020	\$0.37
Rim Cylinder Mounting Screws (#12-24 UNF x 1-7/8" Length)	CP-012917-000	\$0.69
Rim Cylinder Plug Retainer	CP-020010	\$0.80
Screw-on Cap Rim Tailpiece Retainer	CP-021121	\$17.70
Sidebar Spring-Stainless Steel	CP-030018	\$0.11
Back of Plug Roll Pin 3/32" Dia. x .437" Length	CP-060203	\$0.53
5 Pin Sidebar Assembly, .123" high for Door Hardware Cylinders	CP-084571	\$9.83
6 Pin Sidebar Assembly, .123" high for Door Hardware Cylinders	CP-084671	\$9.83
Rim Cylinder Mounting Plate	CP-180031	\$2.18

(P) = Pinned (combined)



(S) = Sub-assembled (uncombined)

Surcharges for Master Keying, Custom Coining and Custom Stamping apply, see page 196.
Refer to the XT and CLIQ Intelligent Key sections for format availability and pricing.

Collars & Cylinder Rings

Description	Part Number	Price
 Tapered Cylinder Collar	94-0188-XX	\$20.10
 1/4" Thick Spacer Ring 1.165" Inside Diameter x 1.375 Outside Diameter	CP-070011	\$34.20
 1/8" Thick Spacer Ring 1.165" Inside Diameter x 1.375 Outside Diameter	CP-070451	\$27.40
 Raised Cylinder Ring	CP-180021	\$12.30
 Flush Cylinder Ring	CP-180041	\$12.10
 Adjustable Cylinder Collar	CP-160180	\$34.20

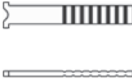
Rim Tailpieces

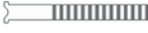
Description	Part Number	Price
 Tailpiece for Rim Cylinder (1-55/64") Before 1980, After 1983	CT-Y02	\$5.46
 Lazy Motion Tailpiece (2 29/64")	CT-Y08	\$5.46
 Tailpiece for Rim Cylinder (2-9/16")	CT-Y32	\$5.46

(P) = Pinned (combined)

(S) = Sub-assembled (uncombined)

Surcharges for Master Keying, Custom Coining and Custom Stamping apply, see page 196.
Refer to the XT and CLIQ Intelligent Key sections for format availability and pricing.

Key-in-Knob/Lever Cylinders

Medeco Key-in-Knob cylinders are designed to retrofit knob type cylindrical locksets, lever type cylindrical locksets, padlocks and bored type auxiliary deadlatches and deadlocks. Medeco 4 (M4) Key-in-Knob cylinders are UL437 listed for drill and pick resistance, and utility patented pending key control. Medeco offers one of the largest ranges of retrofit cylinders in the industry, supporting the most popular security hardware.



Key Control

Patent-pending key control Protects against unauthorized duplication of keys.



Protection Against 3D Printing

A patent-pending movable element in the key deters against unauthorized 3D printed copies of keys or blanks.



Picking and Bumping Protection

M4 cylinders use cylinder side pins, a lift pin and a movable key element to engage a sidebar that prevents the key from turning until the elements are rotated and aligned in the correct position, protecting against bumping, picking and other attacks.



Uses Existing Hardware

M4 cylinders are available in a wide variety of formats, retrofitting most hardware on the market.



Protection From Physical Attack

M4 cylinders are UL 437 listed and UL test lab proven to stand up to drilling, picking and other forms of physical attack.



Special Angled Cut Keys

A special key cutting machine and access to Medeco-specific blanks are required to duplicate M4 keys, which are available in multiple levels of restriction to support every need.



Master Keying Capabilities

M4 cylinders can be master keyed into a system that includes M4 and M4 BiLevel keys and cylinders. Extremely large systems are possible.

Applications:

Over 100 different cylinder designs and tailpiece configurations enable Medeco to offer the largest retrofit capability in the industry.

Warranty:

Warranted for two (2) years against manufacturer's defects. See the Medeco® limited warranty for full details.

Technical Information:

- ANSI/BHMA A156.30 Level A certification assures patent protected key control and physical strength (M4)
- ANSI/BHMA A156.5 Grade 1 certification assures consistent quality for heavy use applications (M4)
- Medeco cylinders are constructed of durable machined brass components

Finishes:

- Available in all standard finishes to match existing hardware

Available Key Technologies:

Mechanical:

- M4/M4 BiLevel
- M³/M³ BiLevel
- X4

Intelligent Key:

- M³ CLIQ
- Classic CLIQ
- XT
- X4 CLIQ

How To Order Key-in-Knob/Lever Cylinders

Complete part numbers are required for all orders. To determine the correct part number, fill in the "Xs" in sequential order.

<p>1</p> <p>20200S1 base part # example</p> <p>Refer to pages 90-104 for descriptions and technical specifications to find the corresponding base part number.</p>	<p>2</p> <p>H technology</p> <p>H = M4 P = M4 BiLevel T = M³ J = M³ BiLevel S = M³ CLIQ W = Biaxial - = Original K = KM C = Classic CLIQ N = X4 M = X4 CLIQ G = XT</p>	<p>3</p> <p>05 finish</p> <p>Refer to the inside back cover of this catalog for finish options. Include the corresponding two digit finish number.</p>	<p>4</p> <p>M4 keyway</p> <p>Insert keyway if known or contact Customer Service for help.</p>	<p>5</p> <p>P pinning</p> <p>S = Sub-Assembled (Uncombined) N = Sub-assembled, - No Side Pins (M4 only) - No slider (M3 only) P = Pinned (Combinated) M = Master Keyed R = Master Keyed - blade and side pins (Medeco 4 only)</p>	<p>6</p> <p>624 side pin code (M4 only)</p> <p>Insert side pin code if known or contact Customer Service for help.</p>
--	---	--	---	---	--

BUILD A KEY-IN-KNOB/LEVER PART #:

20 200S1 X XX XX X XXX

<p>Key-in-Knob/Lever Cylinder</p> <p>Obtain from Product Listing</p> <p>Technology</p> <p>H = M4 P = M4 BiLevel T = M³ J = M³ BiLevel S = M³ CLIQ W = Biaxial - = Original K = KM C = Classic CLIQ N = X4 M = X4 CLIQ G = XT</p>	<p>Finish</p> <p>05 = Bright Brass (US03) 06 = Satin Brass (US04) 09 = Antique Brass (US5) 11 = Bright Bronze (US9) 12 = Satin Bronze (US10) 13 = Dark Bronze/Oil Rubbed (US10B) 18 = Bright Nickel (US14) 19 = Satin Nickel (US15) 20 = Antique Nickel (US15A) 22 = Flat Black (US19) 24 = Dark Bronze/Clear Coat (US20A) 25 = Bright Chrome (US26) 26 = Satin Chrome (US26D)</p>	<p>Side Pin Code (M4 only)</p> <p>Pinning</p> <p>S = Sub Assembled N = Sub Assembled - No side pins (M4 only) - No slider (M3 only) P = Pinned M = Master Keyed R = Master Keyed blade and side pins (M4 only)</p> <p>Keyway</p>
--	---	---

For legacy technology pricing, call Customer Service or visit Medeco.com.



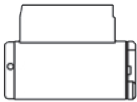

Alarm Lock Cylinder

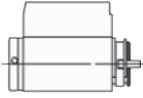
Description	Part Number	M4	M4 BiLevel	M3	M3 BiLevel	X4
 6 Pin Cylinder for Alarm Lock Trilogy® T1, T2, T3	20200V1 (P)	\$176.50	\$96.20	\$183.70	\$99.80	\$112.00
	20200V1 (S)	\$160.00	\$87.20	\$167.20	\$90.80	\$95.50

Anderson® Cylinder

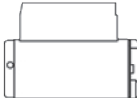
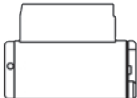
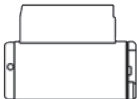
Description	Part Number	M4	M4 BiLevel	M3	M3 BiLevel	X4
 5 Pin Cylinder for Anderson® Doors Frenchwood Hinged and Out Swinging Doors Estate and Metro Design	20110039 (P)	\$176.50	\$96.20	\$183.70	\$99.80	
	20110039 (S)	\$160.00	\$87.20	\$167.20	\$90.80	

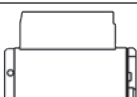
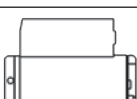
Arrow Cylinder

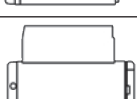
Description	Part Number	M4	M4 BiLevel	M3	M3 BiLevel	X4
 6 Pin Cylinder Package for Arrow® “MK” Series includes CT-Y70, CT-Y73, CP-160321	20200A1 (P)	\$178.81	\$98.51	\$186.01	\$102.11	\$114.31
	20200A1 (S)	\$162.31	\$89.51	\$169.51	\$93.11	\$97.81
 Arrow® and Schlage® Packages Combined	20200H1 (P)	\$187.69	\$107.39	\$194.89	\$110.99	\$123.19
	20200H1 (S)	\$171.19	\$98.39	\$178.39	\$101.99	\$106.69
 6 Pin Cylinder for Arrow® “MK” Series (Except Ball) Original Cylinder Spacer must be replaced with Medeco Cylinder Spacer CP-160321	2020070 (P)	\$176.50	\$96.20	\$183.70	\$99.80	\$112.00
	2020070 (S)	\$160.00	\$87.20	\$167.20	\$90.80	\$95.50
 6 Pin Cylinder for Arrow RK Series	2020071 (P)	\$176.50	\$96.20	\$183.70	\$99.80	\$112.00
	2020071 (S)	\$160.00	\$87.20	\$167.20	\$90.80	\$95.50
 6 Pin Cylinder for Arrow® “MK” Series (B Knob Only) & GL Series Levers	2020073 (P)	\$176.50	\$96.20	\$183.70	\$99.80	\$112.00
	2020073 (S)	\$160.00	\$87.20	\$167.20	\$90.80	\$95.50
 6 Pin Cylinder for Arrow® “H”, “S”, & “HK” Knob Series, “Q”, “L” Series Lever	2020249 (P)	\$176.50	\$96.20	\$183.70	\$99.80	\$112.00
	2020249 (S)	\$160.00	\$87.20	\$167.20	\$90.80	\$95.50
 6 pin cylinder for Arrow “QL” and “MLX” Series Levers	2020049 (P)	\$176.50	\$96.20	\$183.70	\$99.80	\$112.00
	2020049 (S)	\$160.00	\$87.20	\$167.20	\$90.80	\$95.50
 6 Pin Cylinder for Arrow® “M” Series (Tulip or Tudor) Knobs	208008 (P)	\$176.50	\$96.20	\$183.70	\$99.80	\$112.00
	208008 (S)	\$160.00	\$87.20	\$167.20	\$90.80	\$95.50
 6 Pin Cylinder for Arrow® “RL” Series Levers	2080700 (P)	\$176.50	\$96.20	\$183.70	\$99.80	\$112.00
	2080700 (S)	\$160.00	\$87.20	\$167.20	\$90.80	\$95.50

(P) = Pinned (combined)



(S) = Sub-assembled (uncombined)

Surcharges for Master Keying, Custom Coining and Custom Stamping apply, see page 196.
Refer to the XT and CLIQ Intelligent Key sections for format availability and pricing.

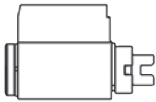
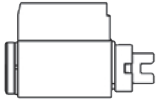
Baldwin® Cylinders

Description	Part Number	M4	M4 BiLevel	M3	M3 BiLevel	X4
 5 Pin Cylinder for Baldwin® for 5245, 5250, 5255 Levers & 5215, 5225 Knobs	2001300 (P)	\$176.50	\$96.20	\$183.70	\$99.80	
	2001300 (S)	\$160.00	\$87.20	\$167.20	\$90.80	
 5 Pin Cylinder for Baldwin® for 5205, 5210 Knobs & 5270, 5280 Levers, (Not available in Original Technology)	2001200 (P)	\$176.50	\$96.20	\$183.70	\$99.80	
	2001200 (S)	\$160.00	\$87.20	\$167.20	\$90.80	

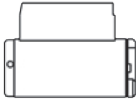
Cal-Royal Cylinders

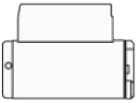





Description	Part Number	M4	M4 BiLevel	M3	M3 BiLevel	X4
 6 Pin Cylinder for Cal-Royal SL00 Knob Lock and LX01 Lever Lock	2020049 (P)	\$176.50	\$96.20	\$183.70	\$99.80	\$112.00
	2020049 (S)	\$160.00	\$87.20	\$167.20	\$90.80	\$95.50
 6 Pin Cylinder for Cal-Royal CLS03 Classroom Function Grade 2 Lever Lock	20200V1 (P)	\$176.50	\$96.20	\$183.70	\$99.80	\$112.00
	20200V1 (S)	\$160.00	\$87.20	\$167.20	\$90.80	\$95.50
 6 Pin Cylinder for K200, L100, LX100, L200, LX200, Levers	20200S1(P)	\$178.81	\$98.51	\$186.01	\$102.11	\$114.31
	20200S1(S)	\$162.31	\$89.51	\$169.51	\$93.11	\$97.81

(P) = Pinned (combined)

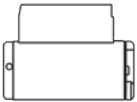
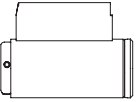
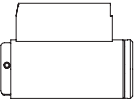
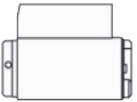
(S) = Sub-assembled (uncombined)

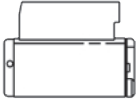
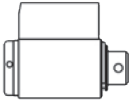
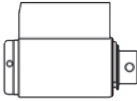
Surcharges for Master Keying, Custom Coining and Custom Stamping apply, see page 196.
Refer to the XT and CLIQ Intelligent Key sections for format availability and pricing.

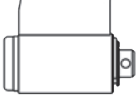
Corbin Russwin® Cylinders

Description	Part Number	M4	M4 BiLevel	M3	M3 BiLevel	X4
 6 Pin Cylinder for Corbin Russwin® CL3900	20200V9 (P)	\$176.50	\$96.20	\$183.70	\$99.80	\$112.00
	20200V9 (S)	\$160.00	\$87.20	\$167.20	\$90.80	\$95.50
 6 Pin Cylinder for Corbin Russwin CLX 3300 Series. (Preferred retrofit; use spacer provided with hardware.)	2020073 (P)	\$176.50	\$96.20	\$183.70	\$99.80	\$112.00
	2020073 (S)	\$160.00	\$87.20	\$167.20	\$90.80	\$95.50
 6 Pin Cylinder for Corbin Russwin® CLX 3300 Series. Smaller plug head diameter than 2020073 (Use spacer provided with hardware)	2020373 (P)	\$176.50		\$183.70		\$112.00
	2020373 (S)	\$160.00		\$167.20		\$95.50
 6 Pin Cylinder for Corbin Russwin® old style 3300 & 3400 Series	2020575 (P)	\$176.50	\$96.20	\$183.70	\$99.80	\$112.00
	2020575 (S)	\$160.00	\$87.20	\$167.20	\$90.80	\$95.50
 6 Pin Cylinder for Corbin Russwin® 6600 Old Series, CK3400, CK4400 Knob	2020777 (P)	\$176.50	\$96.20	\$183.70	\$99.80	\$112.00
	2020777 (S)	\$160.00	\$87.20	\$167.20	\$90.80	\$95.50
 6 Pin Cylinder for Corbin Russwin® 800, CL3300, CL3400, CL3500, CL3600	20211730 (P)	\$176.50	\$96.20	\$183.70	\$99.80	\$112.00
	20211730 (S)	\$160.00	\$87.20	\$167.20	\$90.80	\$95.50
 5 Pin Cylinder for Corbin Russwin® Knob (Old Style)	205003 (P)	\$177.50	\$96.75	\$184.75	\$100.37	\$113.00
	205003 (S)	\$161.00	\$87.75	\$168.25	\$91.37	\$96.50
 6 Pin Cylinder for Corbin Russwin® 5460A, 5460E (Old Style), 46 F97, 46 F29, 83 F05	205004 (P)	\$176.50	\$96.20	\$183.70	\$99.80	\$112.00
	205004 (S)	\$160.00	\$87.20	\$167.20	\$90.80	\$95.50
 6 Pin Cylinder for Corbin Russwin® CK 4200 (New Style) UT5251	205005 (P)	\$176.50	\$96.20	\$183.70	\$99.80	\$112.00
	205005 (S)	\$160.00	\$87.20	\$167.20	\$90.80	\$95.50
 6 Pin Cylinder for Corbin Russwin® 5460 B, C, D, G, M (Old Style)	205006 (P)	\$176.50	\$96.20	\$183.70	\$99.80	\$112.00
	205006 (S)	\$160.00	\$87.20	\$167.20	\$90.80	\$95.50
 5 Pin Cylinder for Corbin Russwin® 5600 Series Signet® & Ensign®	205008 (P)	\$176.50		\$183.70		\$112.00
	205008(S)	\$160.00		\$167.20		\$95.50

(P) = Pinned (combined)

(S) = Sub-assembled (uncombined)

Surcharges for Master Keying, Custom Coining and Custom Stamping apply, see page 196.
Refer to the XT and CLIQ Intelligent Key sections for format availability and pricing.

Dorma® Cylinders

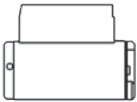
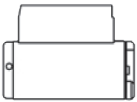
Description	Part Number	M4	M4 BiLevel	M3	M3 BiLevel	X4
 6 Pin Cylinder for Dorma® CL700 Series Grade 2 Levers	2020049 (P)	\$176.50	\$96.20	\$183.70	\$99.80	\$112.00
	2020049 (S)	\$160.00	\$87.20	\$167.20	\$90.80	\$95.50
 6 Pin Cylinder for Dorma® CL860 (Interior), CL870, CL872, CL873, CL877 Grade 1 Lever, CK860 (Interior), CK870, CK872, CK873, & CK877 Grade 1 Knobs	20200V0 (P)	\$176.50	\$96.20	\$183.70	\$99.80	\$112.00
	20200V0 (S)	\$160.00	\$87.20	\$167.20	\$90.80	\$95.50
 6 Pin Cylinder for Dorma® CL853, CL860 (exterior), CL880, CL882, CL80EL, CL80EU Grade 1 Lever, CK853, CK860 (exterior), CK880, CK882, CK80EL, & CK80EU Grade 1 Knobs	20200V1 (P)	\$176.50	\$96.20	\$183.70	\$99.80	\$112.00
	20200V1 (S)	\$160.00	\$87.20	\$167.20	\$90.80	\$95.50

Emtek® Cylinders

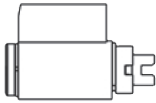
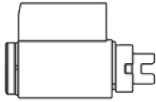
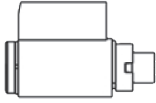



Description	Part Number	M4	M4 BiLevel	M3	M3 BiLevel	X4
 5 Pin Cylinder for Emtek® Knobs	2051100 (P)	\$176.50	\$96.20	\$183.70	\$99.80	
	2051100 (S)	\$160.00	\$87.20	\$167.20	\$90.80	
 5 Pin Cylinder for Emtek® Levers, Except Hanover and Helios	2051200 (P)	\$176.50	\$96.20	\$183.70	\$99.80	
	2051200 (S)	\$160.00	\$87.20	\$167.20	\$90.80	
 5 Pin Cylinder for Emtek Hanover and Helios Levers	2052000 (P)	\$176.50		\$183.70		
	2052000 (S)	\$160.00		\$167.20		

(P) = Pinned (combined)

(S) = Sub-assembled (uncombined)

Surcharges for Master Keying, Custom Coining and Custom Stamping apply, see page 196.
Refer to the XT and CLIQ Intelligent Key sections for format availability and pricing.

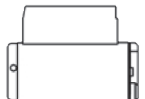
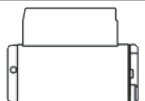
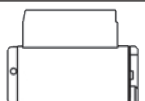
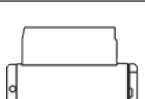
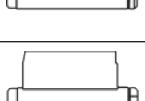
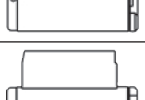
Falcon® Cylinders

Description	Part Number	M4	M4 BiLevel	M3	M3 BiLevel	X4
 6 Pin Cylinder for Falcon® Single Cylinder Deadbolt Lock (New Style)	200903 (P)	\$177.50	\$96.75	\$184.75	\$100.37	\$113.00
	200903 (S)	\$161.00	\$87.75	\$168.25	\$91.37	\$96.50
 6 Pin Cylinder for Falcon® "B" Series	2020049 (P)	\$176.50	\$96.20	\$183.70	\$99.80	\$112.00
	2020049 (S)	\$160.00	\$87.20	\$167.20	\$90.80	\$95.50
 6 Pin Cylinder for Falcon® F521, F561, F581 and "N" Series Knobs	2020051 (P)	\$176.50	\$96.20	\$183.70	\$99.80	\$112.00
	2020051 (S)	\$160.00	\$87.20	\$167.20	\$90.80	\$95.50
 6 Pin Cylinder for Falcon® "S" Series (Except "H" Knob)	2020054 (P)	\$176.50	\$96.20	\$183.70	\$99.80	\$112.00
	2020054 (S)	\$160.00	\$87.20	\$167.20	\$90.80	\$95.50
 6 Pin Cylinder for Falcon® "S" Series ("H" Knob Only)	2020058 (P)	\$176.50	\$96.20	\$183.70	\$99.80	\$112.00
	2020058 (S)	\$160.00	\$87.20	\$167.20	\$90.80	\$95.50
 6 Pin Cylinder for Falcon® "X" Series (Except "H" Knob)	2020068(P)	\$176.50	\$96.20	\$183.70	\$99.80	\$112.00
	2020068(S)	\$160.00	\$87.20	\$167.20	\$90.80	\$95.50
 6 Pin Cylinder for Falcon® "X" Series ("H" Knobs Only) Original Cylinder Spacer must be replaced with Medeco Cylinder Spacer CP-160321	2020071 (P)	\$176.50	\$96.20	\$183.70	\$99.80	\$112.00
	2020071 (S)	\$160.00	\$87.20	\$167.20	\$90.80	\$95.50
 6 Pin Cylinder for Falcon® "LY" Lever	2020072 (P)	\$176.50	\$96.20	\$183.70	\$99.80	\$112.00
	2020072 (S)	\$160.00	\$87.20	\$167.20	\$90.80	\$95.50
 6 Pin Cylinder for Falcon® Inside Cylinder T-381	2020073 (P)	\$176.50	\$96.20	\$183.70	\$99.80	\$112.00
	2020073 (S)	\$160.00	\$87.20	\$167.20	\$90.80	\$95.50
 6 Pin Cylinder for Falcon® "B", "LY", "X", "S", & "T" series includes: CT-Y49, CT-Y54, CT-Y58, CT-Y68, CT-Y71, CT-Y72, CT-V03, CP-160311	20200F1 (P)	\$178.81	\$98.51	\$186.01	\$102.11	\$114.31
	20200F1 (S)	\$162.31	\$89.51	\$169.51	\$93.11	\$97.81
 6 Pin Cylinder for Falcon® "RU" Series and T381 Outside Cylinder	20200V3 (P)	\$176.50	\$96.20	\$183.70	\$99.80	\$112.00
	20200V3 (S)	\$160.00	\$87.20	\$167.20	\$90.80	\$95.50

(P) = Pinned (combined)



(S) = Sub-assembled (uncombined)

Surcharges for Master Keying, Custom Coining and Custom Stamping apply, see page 196.
Refer to the XT and CLIQ Intelligent Key sections for format availability and pricing.

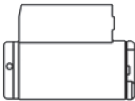

Hager® Cylinders

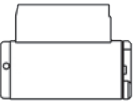
Description	Part Number	M4	M4 BiLevel	M3	M3 BiLevel	X4
 6 Pin Cylinder for Hager® Lever Locksets, 3500 Series	2020249 (P)	\$176.50	\$96.20	\$183.70	\$99.80	\$112.00
	2020249 (S)	\$160.00	\$87.20	\$167.20	\$90.80	\$95.50

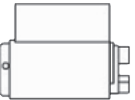

KABA® Mas-Hamilton Cylinders

Description	Part Number	M4	M4 BiLevel	M3	M3 BiLevel	X4
 MAS-Hamilton® Power Lever	20200V1 (P)	\$176.50	\$96.20	\$183.70	\$99.80	\$112.00
	20200V1 (S)	\$160.00	\$87.20	\$167.20	\$90.80	\$95.50
 6 pin cylinder for Kaba E-plex 2000 (18 bow key req. for Orig/Biax)	2051500 (P)	\$176.50	\$96.20	\$183.70	\$99.80	\$112.00
	2051500 (S)	\$160.00	\$87.20	\$167.20	\$90.80	\$95.50

Lockwood® Cylinders

Description	Part Number	M4	M4 BiLevel	M3	M3 BiLevel	X4
 5 Pin Cylinder for Lockwood® 530	201006 (P)	\$176.50		\$183.70		
	201006 (S)	\$160.00		\$167.20		
 6 Pin Cylinder for Lockwood®	2020169 (P)	\$176.50	\$96.20	\$183.70	\$99.80	\$112.00
	2020169 (S)	\$160.00	\$87.20	\$167.20	\$90.80	\$95.50

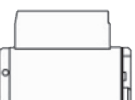
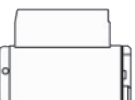
LSDA® Cylinders

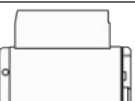
Description	Part Number	M4	M4 BiLevel	M3	M3 BiLevel	X4
 6 Pin cylinder for LSDA® 100 Series Knob (Except "B" Knob), L100 Series Lever	2020070 (P)	\$176.50	\$96.20	\$183.70	\$99.80	\$112.00
	2020070 (S)	\$160.00	\$87.20	\$167.20	\$90.80	\$95.50
 6 Pin Cylinder for LSDA® 100 (B Knob Only)	2020073 (P)	\$176.50	\$96.20	\$183.70	\$99.80	\$112.00
	2020073 (S)	\$160.00	\$87.20	\$167.20	\$90.80	\$95.50
 6 Pin Cylinder for LSDA® LX1000 Lever	2020078 (P)	\$176.50	\$96.20	\$183.70	\$99.80	\$112.00
	2020078 (S)	\$160.00	\$87.20	\$167.20	\$90.80	\$95.50
 6 Pin cylinder package for LSDA® 100, L100, LH1000, LX1000 Series. Includes: CT-Y49, CTY70, CT-Y73, CT-Y78	20200L1 (P)	\$178.81	\$98.51	\$186.01	\$102.11	\$114.31
	20200L1 (S)	\$162.31	\$89.51	\$169.51	\$93.11	\$97.81

(P) = Pinned (combined)

(S) = Sub-assembled (uncombined)

Surcharges for Master Keying, Custom Coining and Custom Stamping apply, see page 196.
Refer to the XT and CLIQ Intelligent Key sections for format availability and pricing.

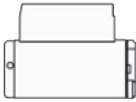
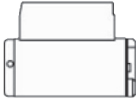

Marks® Cylinders

Description	Part Number	M4	M4 BiLevel	M3	M3 BiLevel	X4
 6 Pin Cylinder for Marks® 110, 170, 180, 190, 195, 295 Series DA-Vestibule, DC & SB Communicating, S-Classroom & Classroom Security Functions	20200V0 (P)	\$176.50	\$96.20	\$183.70	\$99.80	\$112.00
	20200V0 (S)	\$160.00	\$87.20	\$167.20	\$90.80	\$95.50
 6 pin Cylinder for Marks 110, 170, 180, 190, 195, 295 Series in AB-Entrance, DW Institution, F-Storeroom, & T Corridor Functions	20200V1 (P)	\$176.50	\$96.20	\$183.70	\$99.80	\$112.00
	20200V1 (S)	\$160.00	\$87.20	\$167.20	\$90.80	\$95.50

Marvin® Cylinders

Description	Part Number	M4	M4 BiLevel	M3	M3 BiLevel	X4
 5 Pin Cylinder for Marvin® Auxiliary Locks	2000827 (P)	\$176.50	\$96.20	\$183.70	\$99.80	
	2000827 (S)	\$160.00	\$87.20	\$167.20	\$90.80	

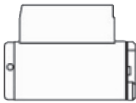
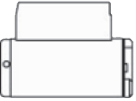

Medeco Embassy® Cylinders

Description	Part Number	M4	M4 BiLevel	M3	M3 BiLevel	X4
 6 Pin Cylinder for Embassy® Vestibule, Communicating, Classroom & Classroom Security Functions. For Embassy Levers sold thru 9/06 & ALL Knobs	20200V0 (P)	\$176.50	\$96.20	\$183.70	\$99.80	\$112.00
	20200V0 (S)	\$160.00	\$87.20	\$167.20	\$90.80	\$95.50
 6 Pin Cylinder for Embassy® in Entrance, Institution, Storeroom, Corridor Functions. For Embassy Levers sold thru 9/06 & ALL Knobs	20200V1 (P)	\$176.50	\$96.20	\$183.70	\$99.80	\$112.00
	20200V1 (S)	\$160.00	\$87.20	\$167.20	\$90.80	\$95.50
 6 Pin Cylinder for Embassy Levers All Functions after 9/2006	2020249 (P)	\$176.50	\$96.20	\$183.70	\$99.80	\$112.00
	2020249 (S)	\$160.00	\$87.20	\$167.20	\$90.80	\$95.50

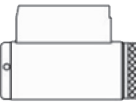
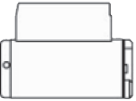
Olympus® Cylinders

Description	Part Number	M4	M4 BiLevel	M3	M3 BiLevel	X4
 6 Pin Cylinder for Olympus® 700LCM, 800LCM Non-key Retaining Cabinet Lock Includes: CT-F34-CT-F38	2000954 (P)	\$182.55	\$102.25	\$189.75	\$105.85	\$118.05
	2000954 (S)	\$166.05	\$93.25	\$173.25	\$96.85	\$101.55
 6 Pin Cylinder for Olympus® 700LCM, 800LCM Key Retaining Cabinet lock, Includes: CT-Y49, CT-Y52, CT-Y53, CT-Y54	20200S1 (P)	\$178.81	\$98.51	\$186.01	\$102.11	\$114.31
	20200S1 (S)	\$162.31	\$89.51	\$169.51	\$93.11	\$97.81

PDQ® Cylinders

Description	Part Number	M4	M4 BiLevel	M3	M3 BiLevel	X4
 6 Pin Cylinder for PDQ® "SX" Series	2020149 (P)	\$176.50	\$96.20	\$183.70	\$99.80	
	2020149 (S)	\$160.00	\$87.20	\$167.20	\$90.80	
 6 Pin Cylinder for PDQ® "SV" Knob/Lever	203000 (P)	\$176.50	\$96.20	\$183.70	\$99.80	\$112.00
	203000 (S)	\$160.00	\$87.20	\$167.20	\$90.80	\$95.50
 6 Pin cylinder for PDQ® Lever SP & ST Series, GT, XGT & GP Series	20200V2 (P)	\$176.50	\$96.20	\$183.70	\$99.80	\$112.00
	20200V2 (S)	\$160.00	\$87.20	\$167.20	\$90.80	\$95.50

(P) = Pinned (combined)







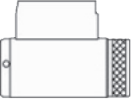
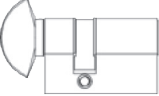

(S) = Sub-assembled (uncombined)

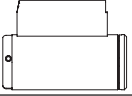
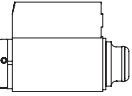
Surcharges for Master Keying, Custom Coining and Custom Stamping apply, see page 196.
Refer to the XT and CLIQ Intelligent Key sections for format availability and pricing.



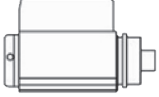

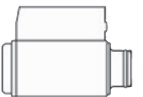



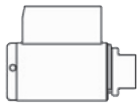

Pella® Cylinders

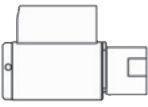
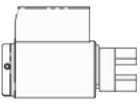
Description	Part Number	M4	M4 BiLevel	M3	M3 BiLevel	X4
 5 Pin Knob cylinder to fit popular Pella storm and patio doors	2000827 (P)	\$176.50	\$96.20	\$183.70	\$99.80	
	2000827 (S)	\$160.00	\$87.20	\$167.20	\$90.80	
 5 Pin profile type cylinder to fit popular Pella and Anderson storm and patio doors	490258 (P)	\$220.50		\$229.68		
	490258 (S)	\$204.00		\$213.18		

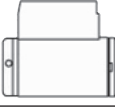
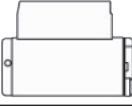
SARGENT® Cylinders

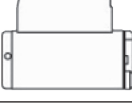
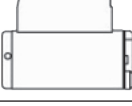
Description	Part Number	M4	M4 BiLevel	M3	M3 BiLevel	X4
 6 Pin Cylinder for SARGENT® 30 - 10X. Use spacer provided with hardware.	2020064 (P)	\$176.50	\$96.20	\$183.70	\$99.80	\$112.00
	2020064 (S)	\$160.00	\$87.20	\$167.20	\$90.80	\$95.50
 6 pin cylinder for SARGENT 10X only. (Use spacer provided with hardware). Not available in Original Design. For Original Design, use 20*20364.	2080161 (P)	\$177.50	\$96.75	\$184.75	\$100.37	\$112.00
	2080161 (S)	\$161.00	\$87.75	\$168.25	\$91.37	\$95.50
 6 Pin Cylinder for SARGENT® 6 Line (Except for B Knob) & 6500 Lever - For Original Design, otherwise use 20*80147	2020170 (P)	\$176.50	\$96.20	\$183.70	\$99.80	\$112.00
	2020170 (S)	\$160.00	\$87.20	\$167.20	\$90.80	\$95.50
 6 Pin cylinder for SARGENT® 6 Line (B Knob Only) Original Cylinder Spacer must be replaced with Medeco Cylinder Spacer CP-160321 (Included) - For Original Design, otherwise use 20*80147	2020173 (P)	\$176.50	\$96.20	\$183.70	\$99.80	\$112.00
	2020173 (S)	\$160.00	\$87.20	\$167.20	\$90.80	\$95.50
 6 Pin Cylinder for SARGENT® 10 Line, Levers 7L & 8L - For Original Design, otherwise use 20*80147	2020349 (P)	\$176.50	\$96.20	\$183.70	\$99.80	\$112.00
	2020349 (S)	\$160.00	\$87.20	\$167.20	\$90.80	\$95.50
 6 Pin Cylinder for SARGENT® 7600 Integra®	208005 (P)	\$176.50	\$96.20	\$183.70	\$99.80	\$112.00
	208005 (S)	\$160.00	\$87.20	\$167.20	\$90.80	\$95.50
 6 Pin Cylinder for SARGENT® 8 & 9 Line knobs	208006 (P)	\$176.50	\$96.20	\$183.70	\$99.80	\$112.00
	208006 (S)	\$160.00	\$87.20	\$167.20	\$90.80	\$95.50
 5 Pin Cylinder for SARGENT® 6 Line Includes: CT-Y35, CT-Y37, CT-Y47, CT-Y55	208007 (P)	\$176.50	\$96.20	\$183.70	\$99.80	\$112.00
	208007 (S)	\$160.00	\$87.20	\$167.20	\$90.80	\$95.50
 6 Pin Cylinder for SARGENT® 6, 7, 10 line, 6500 Series (Not Available in Original Technology) Includes: CT-Y35- CT-Y37- CT-Y47, CT-Y55, CT-V61	2080147 (P)	\$177.50	\$96.75	\$184.75	\$100.37	\$112.00
	2080147 (S)	\$161.00	\$87.75	\$168.25	\$91.37	\$96.50
 6 Pin Cylinder for SARGENT® 11 Line (Not Available in Original Technology)	2080148 (P)	\$177.50	\$96.75	\$184.75	\$100.37	
	2080148 (S)	\$161.00	\$87.75	\$168.25	\$91.37	

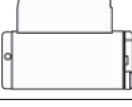
Schlage® Cylinders

Description	Part Number	M4	M4 BiLevel	M3	M3 BiLevel	X4
 5 Pin Knob Cylinder for Schlage® "F" Series Plymouth & Ball Knob (Mfg prior to 2004)	2000400 (P)	\$176.50	\$96.20	\$183.70	\$99.80	
	2000400 (S)	\$160.00	\$87.20	\$167.20	\$90.80	
 6 Pin Cylinder for Schlage® "F" Series Orbit Design Only (Manufactured Prior to 2004)	2000700 (P)	\$176.50	\$96.20	\$183.70	\$99.80	\$112.00
	2000700 (S)	\$160.00	\$87.20	\$167.20	\$90.80	\$95.50
 5 Pin Cylinder for Schlage® "F" Series Lever (Manufactured Prior to 2004)	2001400 (P)	\$176.50	\$96.20	\$183.70	\$99.80	
	2001400 (S)	\$160.00	\$87.20	\$167.20	\$90.80	
 5 Pin Cylinder for Schlage® "F" Series Lever (Manufactured 2004 through 2007)	2001700 (P)	\$176.50	\$96.20	\$183.70	\$99.80	
	2001700 (S)	\$160.00	\$87.20	\$167.20	\$90.80	
 5 Pin Knob Cylinder for Schlage® "A" Series (Ply Only)	200700 (P)	\$176.50	\$96.20	\$183.70	\$99.80	
	200700 (S)	\$160.00	\$87.20	\$167.20	\$90.80	
 5 Pin Knob Cylinder for Schlage® "A" Series (Except Ply)	200701 (P)	\$176.50	\$96.20	\$183.70	\$99.80	
	200701 (S)	\$160.00	\$87.20	\$167.20	\$90.80	
 6 Pin Cylinder for Schlage® "A", "AL", & "D", Series Olympiad® Lever (Use CT-Y73, for "AL" thick doors)	2020049 (P)	\$176.50	\$96.20	\$183.70	\$99.80	\$112.00
	2020049 (S)	\$160.00	\$87.20	\$167.20	\$90.80	\$95.50
 6 Pin Cylinder for Schlage® "C, D" Series (Ply Only)	2020051 (P)	\$176.50	\$96.20	\$183.70	\$99.80	\$112.00
	2020051 (S)	\$160.00	\$87.20	\$167.20	\$90.80	\$95.50
 6 Pin Cylinder for Schlage® "C", & "D" Series Heavy Duty Knobs Ball, Globe & Sphere Designs Only	2020052 (P)	\$176.50	\$96.20	\$183.70	\$99.80	\$112.00
	2020052 (S)	\$160.00	\$87.20	\$167.20	\$90.80	\$95.50
 6 Pin Cylinder for Schlage® "A" Series (Orbit® Only)	2020053 (P)	\$176.50	\$96.20	\$183.70	\$99.80	\$112.00
	2020053 (S)	\$160.00	\$87.20	\$167.20	\$90.80	\$95.50
 6 pin cylinder for Schlage ALX classroom function.	2020063 (P)	\$176.50	\$96.20	\$183.70	\$99.80	\$112.00
	2020063 (S)	\$160.00	\$87.20	\$167.20	\$90.80	\$95.50
 6 Pin Knob Cylinder for Schlage® "ND" & "AL" Series Grade 1 Lever. **See note	2020073 (P)	\$176.50	\$96.20	\$183.70	\$99.80	\$112.00
	2020073 (S)	\$160.00	\$87.20	\$167.20	\$90.80	\$95.50
 6 Pin Knob Cylinder for Schlage® "S" Series	2020097 (P)	\$178.81	\$98.51	\$186.01	\$102.11	\$114.31
	2020097 (S)	\$162.31	\$89.51	\$169.51	\$93.11	\$97.81
 6 Pin Knob Cylinder Assembly for Schlage® & Arrow® (Except Arrow "H" & "S" Series) Includes: CT-Y49, CT-Y52, CTY53, CT-Y70, CT-Y73, CT-Y74, CP-160321 **See note	20200H1 (P)	\$187.69	\$107.39	\$194.89	\$110.99	\$123.19
	20200H1 (S)	\$171.19	\$98.39	\$178.39	\$101.99	\$106.69

(P) = Pinned (combined)

(S) = Sub-assembled (uncombined)

Surcharges for Master Keying, Custom Coining and Custom Stamping apply, see page 196.
Refer to the XT and CLIQ Intelligent Key sections for format availability and pricing.

Schlage® Cylinders

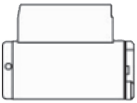
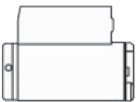

Description	Part Number	M4	M4 BiLevel	M3	M3 BiLevel	X4
 6 Pin Cylinder Package for Schlage A, AL, C, D, ND & Olympiad lever designs, includes: CT-Y49 (A, AL, & D Olympiad Lever & C & D Plymouth), CT-Y52 (C & D heavy duty knobs Ball, Globe & Sphere designs only), CT-Y53 (A series Orbit), CT-Y73 (ND series Gr. 1 lever & AL thick doors), and CT-Y74 (45-101 padlock) (Use CT-Y73 for thick doors) ** See note	20200S1 (P)	\$178.81	\$98.51	\$186.01	\$102.11	\$114.31
	20200S1 (S)	\$162.31	\$89.51	\$169.51	\$93.11	\$97.81
 6 Pin Cylinder for Schlage D Series Lever, Athens, Rhodes & Sparta Designs	2020249 (P)	\$176.50	\$96.20	\$183.70	\$99.80	\$112.00
	2020249 (S)	\$160.00	\$87.20	\$167.20	\$90.80	\$95.50

** The ND series with Sparta trim is not compatible with 17 bow (Biaxial large bow) keys. 12 bow (small bow) or 18 bow (large bow/extended throat) keys must be used instead.

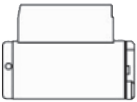
Taco® Cylinders

Description	Part Number	M4	M4 BiLevel	M3	M3 BiLevel	X4
 6 Pin Cylinder TACO® LXV Lever Lockset	2020078 (P)	\$176.50	\$96.20	\$183.70	\$99.80	\$112.00
	2020078 (S)	\$160.00	\$87.20	\$167.20	\$90.80	\$95.50

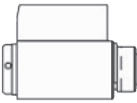
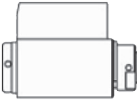
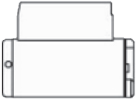
Yale® Cylinders







Description	Part Number	M4	M4 BiLevel	M3	M3 BiLevel	X4
 6 Pin Cylinder for Yale® Knobs 5300, 5400, 6100, 6200	200500 (P)	\$176.50	\$96.20	\$183.70	\$99.80	\$112.00
	200500 (S)	\$160.00	\$87.20	\$167.20	\$90.80	\$95.50
 6 Pin Cylinder for Yale® 5300LN, 5400LN, 4300 series knobs	200503 (P)	\$176.50	\$96.20	\$183.70	\$99.80	\$112.00
	200503 (S)	\$160.00	\$87.20	\$167.20	\$90.80	\$95.50
 6 Pin cylinder for Yale® YMCL100, YMCL200	2020073 (P)	\$176.50	\$96.20	\$183.70	\$99.80	\$112.00
	2020073 (S)	\$160.00	\$87.20	\$167.20	\$90.80	\$95.50
 6 Pin cylinder for Yale® 4600LN	2080700 (P)	\$176.50	\$96.20	\$183.70	\$99.80	\$112.00
	2080700 (S)	\$160.00	\$87.20	\$167.20	\$90.80	\$95.50

(P) = Pinned (combined)

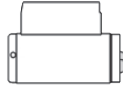

(S) = Sub-assembled (uncombined)

Surcharges for Master Keying, Custom Coining and Custom Stamping apply, see page 196.
Refer to the XT and CLIQ Intelligent Key sections for format availability and pricing.

Arrow® Deadbolt Cylinders

Description	Part Number	M4	M4 BiLevel	M3	M3 BiLevel	X4
 5 Pin Cylinder for Arrow JL Interconnected lock. Separate cylinder required for lever.	1065140 (P)	\$182.50	\$99.47	\$189.97	\$103.20	\$116.32
	1065140 (S)	\$166.00	\$90.47	\$173.47	\$94.20	\$99.82
 5 Pin Cylinder (6 Pin KeyMark) for Arrow D & E Series Single Cylinder Deadbolt	200801 (P)	\$177.50	\$96.75	\$184.75	\$100.37	
	200801 (S)	\$161.00	\$87.75	\$168.25	\$91.37	
 5 Pin Cylinder for Arrow D & E Series Double Cylinder Deadbolt	200802 (P)	\$173.50	\$94.56	\$180.56	\$98.10	
	200802 (S)	\$157.00	\$85.56	\$164.06	\$89.10	
 6 Pin Cylinder for Arrow D & E Series Single Cylinder Deadbolt	200901 (P)	\$177.50	\$96.75	\$184.75	\$100.37	\$113.00
	200901 (S)	\$161.00	\$87.75	\$168.25	\$91.37	\$96.50
 6 Pin Cylinder for Arrow D & E Series Double Cylinder Deadbolt	200902 (P)	\$177.50	\$96.75	\$184.75	\$100.37	\$113.00
	200902 (S)	\$161.00	\$87.75	\$168.25	\$91.37	\$96.50
 6 Pin Cylinder for Arrow Revolution Deadbolt*Order CT-Y27 tailpiece separately	200903 (P)	\$177.50	\$96.75	\$184.75	\$100.37	\$113.00
	200903 (S)	\$161.00	\$87.75	\$168.25	\$91.37	\$96.50

Baldwin® Deadbolt Cylinders

Description	Part Number	M4	M4 BiLevel	M3	M3 BiLevel	X4
 5 Pin Rim Type Lazy Motion Single Cylinder handlesets and deadbolts	1075127 (P)	\$213.59	\$126.01	\$221.51	\$129.97	\$121.86
	1075127 (S)	\$197.09	\$117.01	\$205.01	\$120.97	\$105.36
 5 Pin Lazy Motion cylinder for Baldwin 2 point lock handleset (lower cylinder)	2001851 (P)	\$176.50	\$96.20	\$183.70	\$99.80	
	2001851 (S)	\$160.00	\$87.20	\$167.20	\$90.80	

Cal-Royal® Deadbolt Cylinder

Description	Part Number	M4	M4 BiLevel	M3	M3 BiLevel	X4
 6 Pin Cylinder for Cal-Royal T-300 Series Grade 2 Deadbolt, Includes: CT-F34, DT-F35, CTF36, CT-F37 & CT-F38	2000954 (P)	\$182.55	\$102.25	\$189.75	\$105.85	\$118.05
	2000954 (S)	\$166.05	\$93.25	\$173.25	\$96.85	\$101.55

Corbin Russwin® Deadbolt Cylinder

Description	Part Number	M4	M4 BiLevel	M3	M3 BiLevel	X4
 6 Pin Cylinder for Corbin Russwin DL2100, DL3100 Deadbolt	2051027 (P)	\$176.50	\$96.20	\$183.70	\$99.80	\$112.00
	2051027 (S)	\$160.00	\$87.20	\$167.20	\$90.80	\$95.50

Emtek® Deadbolt Cylinders

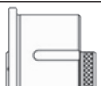

Description	Part Number	M4	M4 BiLevel	M3	M3 BiLevel	X4
 5 Pin Rim Lazy Motion Rim Type Cylinder to fit Emtek® Handleset & Deadbolt Outside Cylinder	1065140 (P)	\$182.50	\$99.47	\$189.97	\$103.20	\$116.32
	1065140 (S)	\$166.00	\$90.47	\$173.47	\$94.20	\$99.82
 5 Pin Rim Lazy Motion Rim Type Cylinder To Inside Cylinder w/Emtek Tailpiece	1065244 (P)	\$192.50	\$104.92	\$200.42	\$108.88	
	1065244 (S)	\$176.00	\$95.92	\$183.92	\$99.88	

(P) = Pinned (combined)

(S) = Sub-assembled (uncombined)

Surcharges for Master Keying, Custom Coining and Custom Stamping apply, see page 196.
Refer to the XT and CLIQ Intelligent Key sections for format availability and pricing.

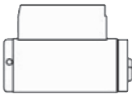
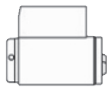
Falcon® Deadbolt Cylinders

Description	Part Number	M4	M4 BiLevel	M3	M3 BiLevel	X4
 6 Pin Cylinder for Falcon Single Cylinder Deadbolt Lock (New Style)	200903 (P)	\$177.50	\$96.75	\$184.75	\$100.37	\$113.00
	200903 (S)	\$161.00	\$87.75	\$168.25	\$91.37	\$96.50
 5 Pin Cylinder for Falcon Single Cylinder Deadbolt Lock (Old Style)	206005 (P)	\$177.50	\$96.75	\$184.75	\$100.37	
	206005 (S)	\$161.00	\$87.75	\$168.25	\$91.37	
 5 Pin Cylinder for Falcon Double Cylinder Deadbolt Lock (Old Style)	206100 (P)	\$176.50	\$96.20	\$183.70	\$99.80	
	206100 (S)	\$160.00	\$87.20	\$167.20	\$90.80	







Kwikset® Deadbolt Cylinders

Description	Part Number	M4	M4 BiLevel	M3	M3 BiLevel	X4
 6 Pin Lazy Motion Rim Type for Kwikset® Single Cylinder deadbolts, except Powerbolt	1012040 (P)	\$186.50	\$101.65	\$194.15	\$105.47	
	1012040 (S)	\$170.00	\$92.65	\$177.65	\$96.47	

PDQ® Deadbolt Cylinder

Description	Part Number	M4	M4 BiLevel	M3	M3 BiLevel	X4
 6 Pin Cylinder for PDQ KV Series Deadbolt	200903 (P)	\$177.50	\$96.75	\$184.75	\$100.37	\$113.00
	200903 (S)	\$161.00	\$87.75	\$168.25	\$91.37	\$96.50

Sargent® Deadbolt Cylinder







Description	Part Number	M4	M4 BiLevel	M3	M3 BiLevel	X4
 6 Pin Cylinder for 470 & 480 Single Cylinder Deadbolt Lock	200901 (P)	\$177.50	\$96.75	\$184.75	\$100.37	\$113.00
	200901 (S)	\$161.00	\$87.75	\$168.25	\$91.37	\$96.50
 6 Pin Cylinder for Sargent 470 & 480 Double Cylinder Deadbolt Lock	200902 (P)	\$177.50	\$96.75	\$184.75	\$100.37	\$113.00
	200902 (S)	\$161.00	\$87.75	\$168.25	\$91.37	\$96.50
 5 Pin Cylinder for Sargent 470 & 480 Single Cylinder Deadbolt	200801 (P)	\$177.50	\$96.75	\$184.75	\$100.37	
	200801 (S)	\$161.00	\$87.75	\$168.25	\$91.37	
 5 Pin Cylinder for Sargent 470 & 480 Double Cylinder Deadbolt	200802 (P)	\$173.50	\$94.56	\$180.56	\$98.10	
	200802 (S)	\$157.00	\$85.56	\$164.06	\$89.10	
 5 Pin cylinder for Sargent 460 Single Cylinder deadbolt	200807 (P)	\$177.50		\$184.75		
	200807 (S)	\$161.00		\$168.25		
 6 Pin cylinder for Sargent 460 Single Cylinder deadbolt	200907 (P)	\$177.50	\$96.75	\$184.75	\$100.37	\$113.00
	200907 (S)	\$161.00	\$87.75	\$168.25	\$91.37	\$96.50
 5 Pin cylinder for Sargent 460 Double Cylinder deadbolt	200808 (P)	\$177.50		\$184.75		
	200808 (S)	\$161.00		\$168.25		

(P) = Pinned (combined)

(S) = Sub-assembled (uncombined)

Surcharges for Master Keying, Custom Coining and Custom Stamping apply, see page 196.
Refer to the XT and CLIQ Intelligent Key sections for format availability and pricing.

Schlage® Deadbolt Cylinder

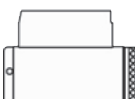
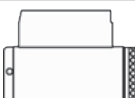



Description	Part Number	M4	M4 BiLevel	M3	M3 BiLevel	X4
 5 Pin Lazy Motion Schlage® Outside Cylinder for "E", "H", B200, B400 Series Deadbolt (Rim Type Cylinder) includes CT-F34-CT-F38	10651S4 (P)	\$208.81	\$125.78	\$216.28	\$129.51	\$142.63
	10651S4 (S)	\$192.31	\$116.78	\$199.78	\$120.52	\$126.13
 5 Pin Lazy Motion Schlage® Inside Cylinder for B200/B400 Series Deadbolt Lock (Rim Type Cylinder) includes CT-F34-CTF38	10652S4 (P)	\$204.49	\$116.91	\$212.41	\$120.87	\$133.85
	10652S4 (S)	\$187.99	\$107.91	\$195.91	\$111.87	\$111.87
 6 Pin Lazy Motion Schlage® Outside Cylinder for "E", "H", B200, B400 Series Deadbolt Lock (Rim Type Cylinder) includes: CT-F34-CT-F38	10661S4 (P)	\$209.87	\$122.29	\$217.79	\$126.25	\$143.69
	10661S4 (S)	\$193.37	\$113.29	\$201.29	\$117.25	\$127.19
 6 Pin Lazy Motion Schlage® Inside Cylinder for B200 and B400 Series Deadbolt Lock (Rim Type Cylinder) includes: CT-F34-CT-F38	10662S4 (P)	\$206.07	\$98.02	\$216.01	\$102.99	\$135.43
	10662S4 (S)	\$189.57	\$89.02	\$199.51	\$93.99	\$118.93
 5 Pin Lazy Motion Cylinder for Schlage B Series Deadbolt Lock (less tailpiece)	2000800 (P)	\$176.50	\$96.20	\$183.70	\$99.80	
	2000800 (S)	\$160.00	\$87.20	\$167.20	\$90.80	
 5 Pin Knob Cylinder for Schlage B, E, and F160 Series Deadbolt lock, includes CT-F34, CT-F38	20008S4 (P)	\$182.55	\$102.25	\$189.75	\$105.85	
	20008S4 (S)	\$166.05	\$93.25	\$173.25	\$96.85	
 6 Pin Lazy Motion Cylinder Schlage B Series (Old Style) deadbolt	200904 (P)	\$177.50	\$96.75	\$184.75	\$100.37	\$113.00
	200904 (S)	\$161.00	\$87.75	\$168.25	\$91.37	\$96.50
 6 Pin Lazy Motion Cylinder for Schlage B Series Deadbolt (less tailpiece) except B662 after 2001	2000900 (P)	\$176.50	\$96.20	\$183.70	\$99.80	\$112.00
	2000900 (S)	\$160.00	\$87.20	\$167.20	\$90.80	\$95.50
 6 Pin Lazy Motion Knob Cylinder for Schlage® "B", "E", and F160 includes: CT-F34, CTF35, CT-F36, CT-F37, CT-F38	20009S4 (P)	\$182.55	\$102.25	\$189.75	\$105.85	\$118.05
	20009S4 (S)	\$166.05	\$93.25	\$173.25	\$96.85	\$101.55

(P) = Pinned (combined)

(S) = Sub-assembled (uncombined)

Surcharges for Master Keying, Custom Coining and Custom Stamping apply, see page 196.
Refer to the XT and CLIQ Intelligent Key sections for format availability and pricing.

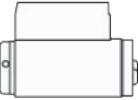
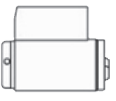
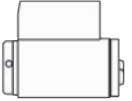
Weiser® Deadbolt Cylinders

Description	Part Number	M4	M4 BiLevel	M3	M3 BiLevel	X4
 5 Pin Lazy Motion Outside Cylinder for Weiser® Prestige Series Deadbolt and Entryset/ Handleset	100602 (P)	\$174.50	\$95.11	\$181.61	\$98.67	
	100602 (S)	\$158.00	\$86.11	\$165.11	\$89.67	
 6 Pin Lazy Motion Outside Cylinder for Weiser Prestige Entryset/Handleset	100702 (P)	\$182.50	\$99.47	\$189.97	\$103.20	
	100702 (S)	\$166.00	\$90.47	\$173.47	\$94.20	
 6 Pin Cylinder for Weiser® Single Cylinder Deadbolt, including powerbolt	200903 (P)	\$177.50	\$96.75	\$184.75	\$100.37	\$113.00
	200903 (S)	\$161.00	\$87.75	\$168.25	\$91.37	\$96.50
 5 Pin Cylinder for Weiser® Single Cylinder Deadbolt	206005 (P)	\$177.50	\$96.75	\$184.75	\$100.37	
	206005 (S)	\$161.00	\$87.75	\$168.25	\$91.37	
 5 Pin Cylinder for Weiser® Double Cylinder Deadbolt	206100 (P)	\$176.50	\$96.20	\$183.70	\$99.80	
	206100 (S)	\$160.00	\$87.20	\$167.20	\$90.80	
 5 Pin Cylinder for Weiser® 4000, 4200 Single Cylinder Deadbolt	207001 (P)	\$177.50	\$96.75	\$184.75	\$100.37	
	207001 (S)	\$161.00	\$87.75	\$168.25	\$91.37	

Yale® Deadbolt Cylinders

Description	Part Number	M4	M4 BiLevel	M3	M3 BiLevel	X4
 6 Pin Cylinder for Yale 3300, 3500, & 3600 Series Deadbolt Locks	2051027 (P)	\$176.50	\$96.20	\$183.70	\$99.80	\$112.00
	2051027 (S)	\$160.00	\$87.20	\$167.20	\$90.80	\$95.50

Abus® Padlock Cylinders

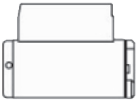
Description	Part Number	M4	M4 BiLevel	M3	M3 BiLevel	X4
 6 Pin Cylinder for Abus® Padlock Series 83KNK/45, 83KNK/50 & 83KNK/55	2020000 (P)	\$176.50	\$96.20	\$183.70	\$99.80	\$112.00
	2020000 (S)	\$160.00	\$87.20	\$167.20	\$90.80	\$95.50

American® Padlock Cylinders

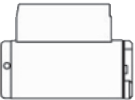
Description	Part Number	M4	M4 BiLevel	M3	M3 BiLevel	X4
 6 Pin Cylinder for American® 3600/3700 Padlock (Note: Use American® Driver DR-MED6)	2020000 (P)	\$176.50	\$96.20	\$183.70	\$99.80	\$112.00
	2020000 (S)	\$160.00	\$87.20	\$167.20	\$90.80	\$95.50

Master® Padlock Cylinders

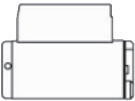
Description	Part Number	M4	M4 BiLevel	M3	M3 BiLevel	X4
 6 Pin Cylinder for Master® “29” and 6600, 6700 Pro Series (Note: Use Master® Driver 0298-627 for Pro Series)	2020000 (P)	\$176.50	\$96.20	\$183.70	\$99.80	\$112.00
	2020000 (S)	\$160.00	\$87.20	\$167.20	\$90.80	\$95.50

(P) = Pinned (combined)

(S) = Sub-assembled (uncombined)

Surcharges for Master Keying, Custom Coining and Custom Stamping apply, see page 196.
Refer to the XT and CLIQ Intelligent Key sections for format availability and pricing.

Medeco System Series Padlock Cylinders

Description	Part Number	M4	M4 BiLevel	M3	M3 BiLevel	X4
 6 Pin cylinder for System Series KIK style padlocks	510600 (P)	\$142.50	\$77.93	\$148.17	\$80.77	\$123.96
	510600 (S)	\$126.00	\$68.93	\$131.67	\$71.77	\$107.46

New Standard Mfg. Co.® Padlock Cylinders

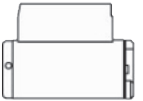
Description	Part Number	M4	M4 BiLevel	M3	M3 BiLevel	X4
 6 Pin Cylinder for New Standard® Padlocks	2020052 (P)	\$176.50	\$96.20	\$183.70	\$99.80	\$112.00
	2020052 (S)	\$160.00	\$87.20	\$167.20	\$90.80	\$95.50

Schlage® Padlock Cylinders

Description	Part Number	M4	M4 BiLevel	M3	M3 BiLevel	X4
 6 Pin Cylinder for Schlage® 45-101 Padlock	2020074 (P)	\$176.50	\$96.20	\$183.70	\$99.80	\$112.00
	2020074 (S)	\$160.00	\$87.20	\$167.20	\$90.80	\$95.50

KIK/KIL Cylinder Components

Description	Part Number	Price
M ³ slider package. (Includes slider & spring)	94-0174	\$16.20
Retaining Ring, Knob Cylinder "E" Clip	CP-020020	\$2.06
Retaining Ring, Knob Cylinder, Full Clip	CP-020040	\$3.96
Retaining Ring, Knob Cylinder Plug Retainer, "C" Clip	CP-020100	\$1.28
Lazy Motion Tailpiece Retainer for 20*090X cylinders	CP-021031	\$2.60
Tailpiece Retainer ring for Arrow and Sargent clip on tailpieces	CP-021130	\$3.69
Plug Retainer, Standard Knob	CP-021370	\$9.98
Castle Nut Retainer for Schlage type lazy motion cylinders	CP-021651	\$15.40
Compression Spring for Schlage type lazy motion cylinders	CP-030670	\$2.06
Drive Disk for Schlage-type Lazy Motion Cylinders	CP-041200	\$5.18
Detent Pin for Schlage-type lazy motion cylinders	CP-064490	\$2.46

KIK/KIL Cylinder Components (Sold in Packs)

Description	Part Number	Pack Size	Price
Flat Head Machine Screw, 5/16" -#2-56 UNC, Phillips with Nylok Patch for 20-200XX Cylinders. Sold in Packs of 100	CP-010203-050	100	\$30.00
Pan Head Machine Screw, 1/4" - #2-56 UNC, Phillips with Nylok Patch for most Lazy Motion Cylinders. Sold in Packs of 100	CP-010503-040	100	\$44.00

KIK/KIL Cylinder Plugs

Description	Part Number	Price
Plug for 20T200XX (Medeco ³)	1212633 T	\$75.66
Plug for 20H200XX (Medeco 4)	12832716	\$72.40
Plug for 20P200XX (Medeco 4 BiLevel)	1251472P	\$73.12
Plug for 20J200XX (Medeco 3 BiLevel)	1251460J	\$76.66

Mailbox Lock Cylinders













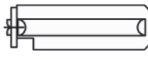

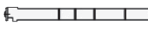
Description	Part Number	(S) Pricing	(P) Pricing
6 Pin M ³ Key in Knob Style Mailbox cylinder, less slider	490375 T	\$194.55	N/A
6 Pin Mailbox cylinder. Medeco KM only	200155 K	\$143.01	\$159.51

(P) = Pinned (combined)

(S) = Sub-assembled (uncombined)

Surcharges for Master Keying, Custom Coining and Custom Stamping apply, see page 196.
Refer to the XT and CLIQ Intelligent Key sections for format availability and pricing.

KIK/KIL Cylinder Tailpieces

Description	Part Number	Price
 Tailpiece for Schlage® B200, B400, B500, Series (Double Cylinder)	CT-F34	\$5.46
 Tailpiece for Schlage® F160, B100, B200, B400, B500 Series (Double Cylinder)	CT-F35	\$5.46
 Tailpiece for Schlage® B200, B400 Series (Double Cylinder)	CT-F36	\$5.46
 Tailpiece for Schlage® F160, B100, B200, B400, B500 Series (Double Cylinder)	CT-F37	\$5.46
 Tailpiece for Schlage® "E", F160, "H", B100, B200, B400, B500 Series (Single Cylinder)	CT-F38	\$5.46
 Tailpiece for Baldwin® Images Series	CT-F40	\$16.80
 Tailpiece for Marks® 190S Lever Lockset	CT-V00	\$5.46
 Tailpiece for Marks® 190AB Lever Lockset	CT-V01	\$5.46
 Tailpiece for PDQ® SP	CT-V02	\$5.46
 Tailpiece for Falcon® "T" Series	CT-V03	\$5.46
 Tailpiece for Corbin® Russwin® 3900 Series Lever Lock	CT-V19	\$5.46
 Tailpiece for Sargent® 11 Line TZone	CT-V35	\$11.60
 Tailpiece for Anderson® Door Locks	CT-V39	\$5.46
 Tailpiece for Kwikset®	CT-V40	\$23.00
 Tailpiece for Schlage® ALX Classroom function cylinder.	CT-V63	\$34.70
 Tailpiece for Schlage® Lazy Motion	CT-Y08	\$5.46











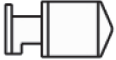



(P) = Pinned (combined)

(S) = Sub-assembled (uncombined)

Surcharges for Master Keying, Custom Coining and Custom Stamping apply, see page 196.

Refer to the XT and CLIQ Intelligent Key sections for format availability and pricing.

KIK/KIL Cylinder Tailpieces









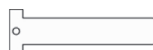

Description	Part Number	Price
 Tailpiece for Schlage® Deadbolt Lock (.542")	CT-Y24	\$5.46
 Tailpiece for Baldwin®, Falcon®, Marvin®, Weiser® & Yale® (Lazy Motion)	CT-Y27	\$5.46
 Tailpiece for Schlage® "G" Series Knob Lock	CT-Y28	\$26.10
 Tailpiece for Weiser® 4370 Deadbolt Lock	CT-Y29	\$5.46
 Tailpiece for Dexter® Double Cylinder Deadbolt Lock 4209	CT-Y31	\$5.46
 Tailpiece for Sargent® 6 Line (.685" Length)	CT-Y35	\$5.46
 Tailpiece for Sargent® 6 Line	CT-Y37	\$5.46
 Tailpiece for Russwin® Forum (20-5008) Line	CT-Y46	\$5.46
 Tailpiece for Arrow® 151 Knob and Sargent® 10 Line	CT-Y47	\$5.46
 Tailpiece for Schlage® "C", "D", & Olympiad® Lever & Falcon® "B", "F" Series	CT-Y49	\$5.46
 Tailpiece for Schlage® "A" Series & "C", "D" Series (Ball, Globe, Sphere Design)	CT-Y52	\$5.46
 Tailpiece for Schlage® "A" Series (Orbit Design Only)	CT-Y53	\$5.46
 Tailpiece for Falcon® "S" Series Knob (Except "H" Knob)	CT-Y54	\$5.46
 Tailpiece for Sargent® 10 Line	CT-Y55	\$5.46
 Tailpiece for Yale® AU5400 Lever Handle (Old Style)	CT-Y57	\$5.46

(P) = Pinned (combined)

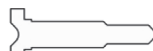
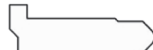
(S) = Sub-assembled (uncombined)

Surcharges for Master Keying, Custom Coining and Custom Stamping apply, see page 196.
Refer to the XT and CLIQ Intelligent Key sections for format availability and pricing.

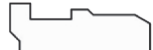
KIK/KIL Cylinder Tailpieces

Description	Part Number	Price
 Tailpiece for Schlage® Deadbolt Lock (.542")	CT-Y58	\$5.46
 Tailpiece for Baldwin®, Falcon®, Marvin®, Weiser® & Yale® (Lazy Motion)	CT-Y67	\$5.46
 Tailpiece for Schlage® “G” Series Knob Lock	CT-Y68	\$5.46
 Tailpiece for Weiser® 4370 Deadbolt Lock	CT-Y69	\$5.46
 Tailpiece for Dexter® Double Cylinder Deadbolt Lock 4209	CT-Y70	\$5.46
 Tailpiece for Sargent® 6 Line (.685" Length)	CT-Y71	\$5.46
 Tailpiece for Sargent® 6 Line	CT-Y72	\$5.46
 Tailpiece for Russwin® Forum (20-5008) Line	CT-Y73	\$5.46
 Tailpiece for Arrow® 151 Knob and Sargent® 10 Line	CT-Y74	\$5.46
 Tailpiece for Schlage® “C”, “D”, & Olympiad® Lever & Falcon® “B”, “F” Series	CT-Y75	\$5.46
 Tailpiece for Schlage® “A” Series & “C”, “D” Series (Ball, Globe, Sphere Design)	CT-Y77	\$5.46
 Tailpiece for Schlage® “A” Series (Orbit Design Only)	CT-Y78	\$5.46
 Tailpiece for Falcon® “S” Series Knob (Except “H” Knob)	CT-Y97	\$37.40

(P) = Pinned (combined)

(S) = Sub-assembled (uncombined)

Surcharges for Master Keying, Custom Coining and Custom Stamping apply, see page 196.
Refer to the XT and CLIQ Intelligent Key sections for format availability and pricing.

KIK/KIL Tailpiece Packages

Description	Part Number	Price
Tailpiece Package for Arrow®: Listed as A1 in cylinder part number. Includes CT-Y70, CT-Y73 & CP-160321 (Spacer)	94-0034	\$15.70
Tailpiece Package for Schlage®: Listed as S1 in cylinder part number. Includes CT-Y49, CT-Y52, CT-Y53, CT-Y73, CT-Y74	94-0036	\$15.70
Tailpiece Package for Falcon®: Listed as F1 in cylinder part number. Includes CT-Y49, CT-Y54, CT-Y58, CT-Y68, CT-Y71, CT-Y72 & CP-160311	94-0035	\$15.70
Tailpiece Package for LSDA®: Listed as L1 in cylinder part number. Includes CT-Y49, CT-Y70, CT-Y73, CT-78	94-0272	\$15.70
Tailpiece Package for Schlage® "S" Series: Includes CT-Y97 & CP-021370	94-0051	\$39.50
Tailpiece package for Arrow®, Schlage® & Sargent®: Listed as H1 in cylinder part number. Includes CT-Y49, CT-Y52, CT-Y53, CTY70, CT-Y73, CT-Y74, & CP-160321	94-0061	\$27.70
Tailpiece Package for Sargent® & Arrow®: Includes CT-Y35, CT-Y37, CT-Y47, CT-Y55, CT-V61 (for SARGENT 10X)	94-0067	\$4.53
Tailpiece Package for Schlage® Deadbolt Cylinders: Listed as S4 in cylinder part number. Includes CT-F34, CT-F35, CT-F36, CT-F37, CT-F38	94-0098	\$15.70

(P) = Pinned (combined)

(S) = Sub-assembled (uncombined)

Surcharges for Master Keying, Custom Coining and Custom Stamping apply, see page 196.
Refer to the XT and CLIQ Intelligent Key sections for format availability and pricing.

Large Format Interchangeable Core



Offering increased security without costly and time-consuming rekeying, interchangeable core cylinders enable quick and easy cylinder changes by non-technical personnel by using a special control key to remove the cylinder (core) from the lock housing. A core with a new combination can then be inserted, which in effect rekeys the lock. LFIC cylinders are often used on doors of high-turnover businesses, like fast-food or manufacturing environments, where rapid rekeying is often desirable. Medeco 4's (M4) patent-pending high security technology provides protection against unauthorized duplication of keys, along with hardened inserts to resist drilling, and features that protect against other types of attack.



Key Control

Patent-pending key control protects against unauthorized duplication of keys.



Protection Against 3D Printing

A patent-pending movable element in the key deters unauthorized 3D printed copies of keys or blanks.



Picking and Bumping Protection

M4 cylinders use cylinder side pins, a lift pin and a movable key element to engage a sidebar that prevents the key from turning until the elements are rotated and aligned in the correct position, protecting against bumping, picking and other attacks.



Protection From Physical Attack

M4 LFIC cylinders are UL 437 listed to stand up to drilling, picking and other forms of physical attack.



Special Angled Cut Keys

A special key cutting machine and access to Medeco-specific blanks are required to duplicate M4 keys, which are available in multiple levels of restriction to support every need.



Quickly Change Cores

Provides quick and easy cylinder changes in the event keys are lost or stolen.



Uses Existing Hardware

Medeco offers a large selection of retrofit LFIC that reduce cost by eliminating the need to replace existing hardware.



Master Keying Capabilities

M4 cylinders can be master keyed into a system that includes M4 and M4 BiLevel keys and cylinders. Very large systems are possible.

Technical Information:

- Meets ANSI/BHMA A156.30 assuring patent protected key control and physical strength (M4)
- ANSI/BHMA A156.5 Grade 1 certification assures consistent quality for heavy use applications (Medeco 4)
- Solid brass construction provides high quality and long cylinder life
- Nickel plated pins provide exceptional wear resistance and additional hardened stainless steel pins provide drill resistance
- Ability to key with non-interchangeable core cylinders for cost effective system flexibility

Applications:

Office buildings, universities, apartments, perimeter doors, schools and hospitals.

Warranty:

Warranted for two (2) years against manufacturer's defects. See Medeco's limited warranty for full details.

Finishes:

Available in all standard finishes to match with existing hardware.

Available Technologies:

Mechanical:

- M4/M4 BiLevel
- M³/M³ BiLevel
- X4

Intelligent Key:

- M³ CLIQ
- Classic CLIQ
- XT
- X4 CLIQ

Build a Base Part

Choose the manufacturer you are retrofitting	Choose the number of pins	Beginning of your Part Number
Medeco	5	32
Medeco	6	32
Schlage	5 (M4 and M3 only)	322201
Schlage	6 (X4 only, Note: requires 7 pin key blank – KYB387631XX05)	322201
Corbin Russwin	6	322301
Corbin Russwin	7	322801
Sargent	6	322401
Yale	6 (requires special 6 pin control blank)	310100
Yale	7 (requires special 6 pin control blank)	310100A





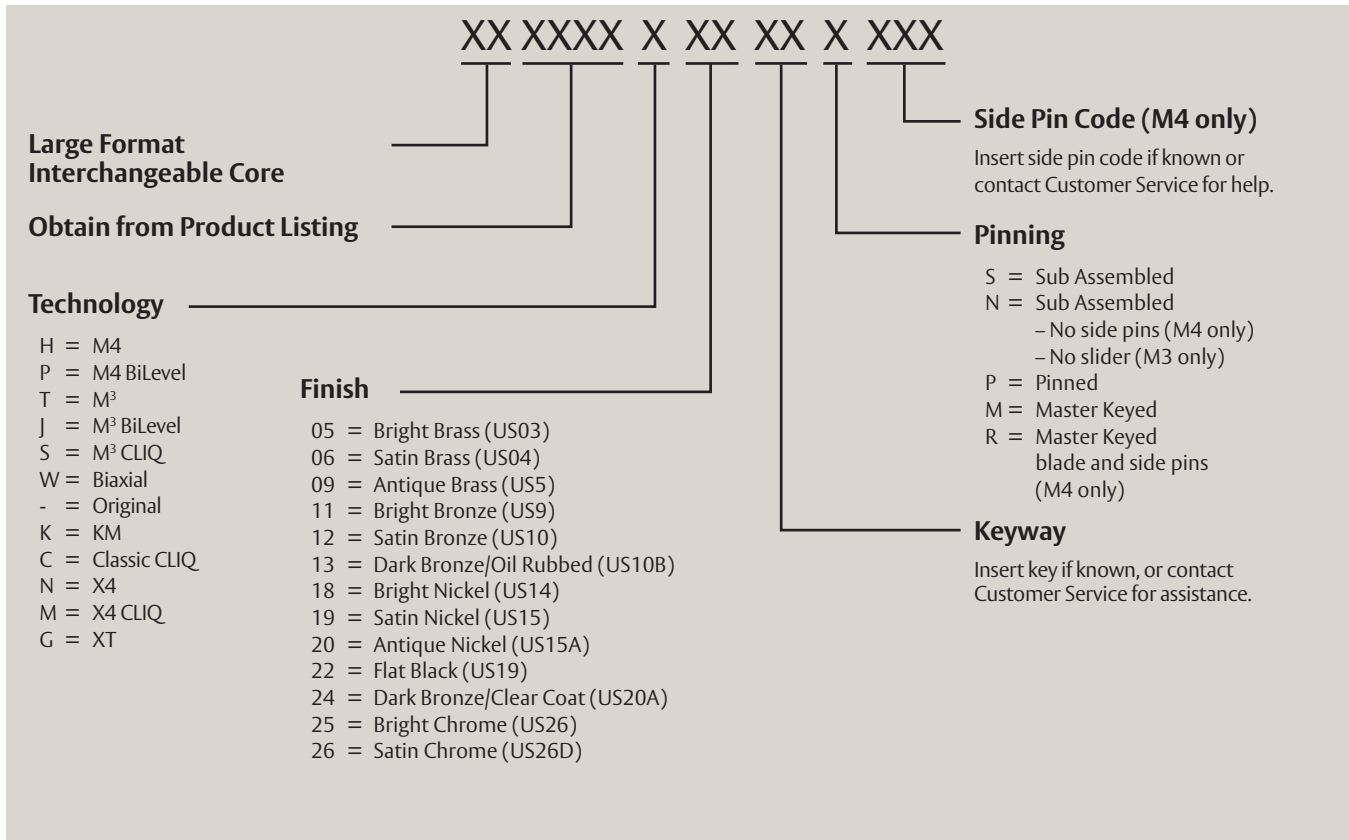



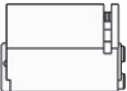

How to Order Large Format Interchangeable Cores:

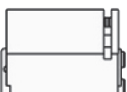
(P) = Pinned (S) = Sub-Assembled









For legacy technology pricing, call Customer Service or visit Medeco.com.

Large Format Interchangeable Core

Description	Part Number	M4	M4 BiLevel	M3	M3 BiLevel	X4
 Yale® Large Format Interchangeable Core, 6 Pin (Masterkey upcharges apply)	310100 (P)	\$192.50	\$106.97	\$200.42	\$110.93	\$127.34
	310100 (S)	\$176.00	\$97.97	\$183.92	\$101.93	\$110.84
 Control Key blank for 31-0100 cylinders	KYB XX6X11	\$11.90				
 6 Pin Core for 7 Pin Yale® Large Format Interchangeable Core Housing (Masterkey upcharges apply)	310100A (P)	\$192.50	\$106.97	\$200.42	\$110.93	\$127.34
	310100A (S)	\$176.00	\$97.97	\$183.92	\$101.93	\$110.84
 Control key blank for 31-0100A cylinders	KYB XX7X11	\$11.90	\$11.90	\$11.90	\$11.90	\$11.90
 5 Pin Large Format Interchangeable Core (Masterkey upcharges apply)	320101 (P)	\$191.50	\$104.38	\$199.38	\$108.31	
	320101 (S)	\$175.00	\$95.38	\$182.88	\$99.31	
 5 Pin Large Format Interchangeable Core for Simplex® Unican® 1000-2m Manufactured Before 2/10/92 (Masterkey upcharges apply)	320101H (P)	\$191.50		\$199.38		
	320101H (S)	\$175.00		\$182.88		
 6 Pin Large Format Interchangeable Core (Masterkey upcharges apply)	320201 (P)	\$192.50	\$104.92	\$200.42	\$108.88	\$134.35
	320201 (S)	\$176.00	\$95.92	\$183.92	\$99.88	\$117.85
 6 Pin Large Format Interchangeable Core for Simplex® Unican® 1000-2m Manufactured Before 2/10/92 (Masterkey upcharges apply)	320201H (P)	\$192.50	\$104.92	\$200.42	\$108.88	
	320201H (S)	\$176.00	\$95.92	\$183.92	\$99.88	
 6 Pin Large Format Hotel Function Interchangeable Core (Masterkey upcharges apply)	321201 (P)	\$195.50		\$203.56		
	321201 (S)	\$179.00		\$187.06		
 6 Pin Large Format Interchangeable Core with Extended Plug Face (Masterkey upcharges apply)	324201 (P)	\$192.50	\$104.92	\$200.42	\$108.88	
	324201 (S)	\$176.00	\$95.92	\$183.92	\$99.88	

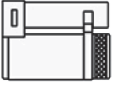
(P) = Pinned (combined)
 (S) = Sub-assembled (uncombined)
 Surcharges for Master Keying, Custom Coining and Custom Stamping apply, see page 196.
 Refer to the XT and CLIQ Intelligent Key sections for format availability and pricing.

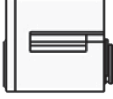
Large Format Interchangeable Core









Description	Part Number	M4	M4 BiLevel	M3	M3 BiLevel	X4
 6 Pin Emergency Key blank for 321201	KYB XX6620 XX 05	\$11.90				
 X4 Control Key blank for 322201	KYB XX7X31					\$11.90
 5 Pin Large Format Interchangeable Core (Schlage®) – (NOTE: X4 comes in 6 pin; Masterkey upcharges apply for all technology)	322201 (P)	\$200.50		\$208.78		\$131.12
	322201 (S)	\$184.00		\$192.28		\$114.62
 M ³ Control Key blank for 322201	KYB XX6X31	\$11.90		\$11.90		
 6 Pin Large Format Interchangeable Core (Corbin Russwin®) (Masterkey upcharges apply) Not available in Original Technology*	322301 (P)	\$192.50		\$200.42		\$134.35
	322301 (S)	\$176.00		\$183.92		\$117.85
 6 Pin Large Format Interchangeable Core (Sargent®), (Masterkey upcharges apply) Not available in Original Technology*	322401 (P)	\$192.50		\$200.42		\$134.35
	322401 (S)	\$176.00		\$183.92		\$117.85
 7 Pin Large Format Interchangeable Core (Corbin Russwin®), (Masterkey upcharges apply)	322801 (P)					\$145.35
	322801 (S)					\$128.85

(P) = Pinned (combined)

(S) = Sub-assembled (uncombined)



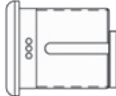
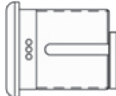

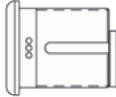
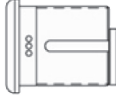







Surcharges for Master Keying, Custom Coining and Custom Stamping apply, see page 196.
Refer to the XT and CLIQ Intelligent Key sections for format availability and pricing.

LFIC Mortise Cylinders

Description	Part Number	M4	M4 BiLevel	M3	M3 BiLevel	X4
 6 Pin Mortise Cylinder for Yale® (Masterkey upcharges apply)	310101 (P)	\$312.50	\$226.97	\$325.82	\$233.63	
	310101 (S)	\$296.00	\$217.97	\$309.32	\$224.63	
 7 Pin Mortise Cylinder Assembly for Yale® (Masterkey upcharges apply)	310101A (P)	\$312.50	\$226.97	\$325.82	\$233.63	
	310101A (S)	\$296.00	\$217.97	\$309.32	\$224.63	
 5 Pin 1-1/8" Mortise Cylinder Assembly (Masterkey upcharges apply)	320100 (P)	\$311.50	\$221.40	\$324.77	\$228.04	
	320100 (S)	\$295.00	\$212.40	\$308.27	\$219.04	
 6 Pin 1-1/4" Mortise Cylinder Assembly (Masterkey upcharges apply)	320200 (P)	\$312.50	\$222.12	\$325.82	\$228.78	
	320200 (S)	\$296.00	\$213.12	\$309.32	\$219.78	
 6 Pin LFIC Mortise Cylinder Assembly Hotel Function (Masterkey upcharges apply)	321200 (P)	\$315.50		\$328.96		
	321200 (S)	\$299.00		\$312.46		
 6 Pin Mortise Cylinder Master Corbin Russwin® Ring Size Assembly (Masterkey upcharges apply)	321350 (P)	\$359.50		\$374.94		
	321350 (S)	\$343.00		\$358.44		
 6 Pin 1-1/2" LFIC Mortise Cylinder Assembly (Masterkey upcharges apply)	325200 (P)	\$518.50		\$541.09		
	325200 (S)	\$502.00		\$524.59		
 6 Pin 1-3/4" LFIC Mortise Cylinder Assembly (Masterkey upcharges apply)	325400 (P)	\$538.50		\$561.99		
	325400 (S)	\$522.00		\$545.49		
 6 Pin 2" LFIC Mortise Cylinder Assembly (Masterkey upcharges apply)	325500 (P)	\$553.50		\$577.66		
	325500 (S)	\$537.00		\$561.16		
 6 Pin 2-5/8" LFIC Mortise Assembly (Masterkey upcharges apply)	325600 (P)	\$594.50		\$620.51		
	325600 (S)	\$578.00		\$604.01		
 6 Pin 3" LFIC Mortise Assembly (Masterkey upcharges apply)	325700 (P)	\$619.50		\$646.63		
	325700 (S)	\$603.00		\$630.13		

(P) = Pinned (combined)
 (S) = Sub-assembled (uncombined)
 Surcharges for Master Keying, Custom Coining and Custom Stamping apply, see page 196.
 Refer to the XT and CLIQ Intelligent Key sections for format availability and pricing.

LFIC Mortise Housings









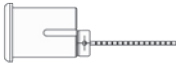

Description	Part Number	Price
 5 Pin Mortise Cylinder Housing	32-0175	\$122.00
 6 Pin Mortise Cylinder Housing	32-0275	\$122.00
 6 Pin Jumbo Mortise Cylinder Housing for Corbin® Russwin® Master Ring Cylinders	32-1375	\$169.00
 1-1/2" Mortise Cylinder Housing for 32-5200	32-5275	\$330.00
 1-3/4" Mortise Cylinder Housing for 32-5400	32-5475	\$348.00
 2" Mortise Cylinder Housing for 32-5500	32-5575	\$364.00
 2-1/4" Mortise Cylinder Housing for 32-5300	32-5375	\$383.00
 2-5/8" Mortise Cylinder Housing for 32-5600	32-5675	\$404.00
 3" Mortise Cylinder Housing for 32-5700	32-5775	\$431.00
 6 Pin 1 3/8" Mortise Cylinder Housing (Yale®)	31-0175	\$122.00
 7 Pin Mortise Cylinder Housing (Yale®)	31-0175A	\$122.00
 2-1/4" Mortise Cylinder Housing (Yale®)	31-5375	\$369.00

(P) = Pinned (combined)

(S) = Sub-assembled (uncombined)









Surcharges for Master Keying, Custom Coining and Custom Stamping apply, see page 196.
Refer to the XT and CLIQ Intelligent Key sections for format availability and pricing.

LFIC Rim Cylinders

Description	Part Number	M4	M4 BiLevel	M3	M3 BiLevel	X4
 6 Pin Rim Cylinder Assembly for Yale®, Horizontal Tailpiece (Masterkey upcharges apply)	310102H (P)	\$322.50	\$236.97	\$336.27	\$243.85	
	310102H (S)	\$306.00	\$227.97	\$319.77	\$234.85	
 6 Pin Rim Cylinder Assembly for Yale®, Vertical Tailpiece (Masterkey upcharges apply)	310102V (P)	\$322.50	\$229.32	\$336.27	\$236.21	
	310102V (S)	\$306.00	\$220.32	\$319.77	\$227.21	
 7 Pin Rim Cylinder Assembly for Yale®, Horizontal Tailpiece (Masterkey upcharges apply)	310104H (P)	\$322.50		\$336.27		
	310104H (S)	\$306.00		\$319.77		
 7 Pin Rim Cylinder Assembly for Yale®, Vertical Tailpiece (Masterkey upcharges apply)	310104V (P)	\$322.50		\$336.27		
	310104V (S)	\$306.00		\$319.77		
 5 Pin Rim Cylinder Assembly with Horizontal Tailpiece and Staked Tailpiece Retainer for Thin Door Applications (Masterkey upcharges apply)	320300H (P)	\$302.50	\$214.92	\$315.37	\$221.35	
	320300H (S)	\$286.00	\$205.92	\$298.87	\$212.35	
 5 Pin Rim Cylinder Assembly, Vertical Tailpiece (Masterkey upcharges apply)	320300V (P)	\$302.50	\$214.92	\$315.37	\$221.35	
	320300V (S)	\$286.00	\$205.92	\$298.87	\$212.35	
 6 Pin Rim Cylinder Assembly, Horizontal Tailpiece (Masterkey upcharges apply)	320400H (P)	\$322.50	\$229.32	\$336.27	\$236.21	
	320400H (S)	\$306.00	\$220.32	\$319.77	\$227.21	
 6 Pin Rim Cylinder Assembly, Vertical Tailpiece (Masterkey upcharges apply)	320400V (P)	\$322.50	\$229.32	\$336.27	\$236.21	
	320400V (S)	\$306.00	\$220.32	\$319.77	\$227.21	
 5 Pin Rim Cylinder Assembly with Lazy Motion Tailpiece (Masterkey upcharges apply)	320600 (P)	\$291.50		\$303.88		
	320600 (S)	\$275.00		\$287.38		
 6 Pin Lazy Motion Rim Cylinder Assembly (Masterkey upcharges apply)	320700 (P)	\$323.50		\$337.31		
	320700 (S)	\$307.00		\$320.81		
 6 pin Rim Cylinder with Sargent mounting holes (Masterkey upcharges apply)	320405H (P)	\$342.50		\$357.17		
	320405H (S)	\$326.00		\$340.67		

(P) = Pinned (combined)
 (S) = Sub-assembled (uncombined)
 Surcharges for Master Keying, Custom Coining and Custom Stamping apply, see page 196.
 Refer to the XT and CLIQ Intelligent Key sections for format availability and pricing.

LFIC Rim Cylinder Housings

Description	Part Number	Price
 7 Pin Rim Cylinder Housing (Yale®), Horizontal Tailpiece	31-0153H	\$131.00
 7 Pin Rim Cylinder Housing (Yale®), Vertical Tailpiece	31-0153V	\$131.00
 6 Pin 1-1/2" Rim Cylinder Housing (31 series for Yale®), Horizontal Tailpiece	31-0375H	\$131.00
 6 Pin 1-1/2" Rim Cylinder Housing (31 series for Yale®), Vertical Tailpiece	31-0375V	\$131.00
 6 Pin Rim Cylinder Housing - 31 Series with Sargent® mounting hole spacing	31-0375S	\$131.00
 5 Pin Rim Cylinder Housing, Horizontal Tailpiece	32-0375H	\$116.00
 5 Pin Rim Cylinder Housing, Vertical Tailpiece	32-0375V	\$116.00
 6 Pin Rim Cylinder Housing, Horizontal Tailpiece	32-0475H	\$131.00
 6 Pin Rim Housing, Vertical Tailpiece	32-0475V	\$131.00
 6 Pin Rim Cylinder Housing – 32 Series with Sargent® mounting hole spacing	32-0477H	\$131.00
 5 Pin Rim Cylinder Housing with Lazy Motion Tailpiece	32-0675	\$114.00
 6 Pin Rim Lazy Motion Cylinder Housing	32-0775	\$133.00

(P) = Pinned (combined)

(S) = Sub-assembled (uncombined)

Surcharges for Master Keying, Custom Coining and Custom Stamping apply, see page 196.
Refer to the XT and CLIQ Intelligent Key sections for format availability and pricing.

Small Format Interchangeable Core (SFIC)

Medeco Small Format Interchangeable Core (SFIC) products are industry standard and compatible with existing door hardware.

They offer rapid combination changes that can be managed by non-technical personnel using a special control key to remove the cylinder (core) from the lock housing. A core with a new combination can then be inserted, which in effect rekeys the lock. All of this can be done without having to take the lock apart.

Medeco SFICs are the easiest way to upgrade security for cylinders that are already in place. Medeco's industry-standard SFIC products include:

- **Medeco X4:** Provides patented protection against unauthorized key duplication through 2030.
- **Medeco B:** Cylinders are compatible with popular keyways such as A-Q, W and T.
- **Medeco XT:** Offers audit information, scheduling, and analytics in an SFIC format. (Refer to Medeco XT section of the catalog for more details.)

By using existing door hardware, Medeco SFICs help reduce cost while upgrading security.



Patented Key Control

Protects against unauthorized duplication of your keys.



Uses Existing Hardware

Industry standard Small Format Interchangeable Cores (SFIC) size, reduces cost by eliminating the need to replace your existing hardware.



Quickly Change Cores

Provides quick and easy cylinder changes in the event keys are lost or stolen.

Technical Information:

- SFICs are available in six or seven pin cylinders, and can replace Best style cores
- Solid brass construction for excellent durability
- Spool shaped top and bottom pins add a measure of pick resistance (X4 and Medeco B)
- Individual pin chamber caps provide ease of servicing

Applications:

Convenience stores and fast-food restaurants, schools, office buildings, hospitals, and wherever else SFIC's need to be upgraded.

Warranty:

Warranted for two (2) years against manufacturer's defects. See the Medeco® limited warranty for full details.

Finishes:

X4 and Medeco B SFIC's are available in all standard finishes to match with existing hardware.

(See finishes on inside back cover.)

XT SFIC's are available in:

- 06 – Satin Brass
- 12 – Satin Bronze
- 13 – Dark Bronze/Oil rubbed
- 26 – Satin Chrome
- BB – Matte Black

(Note: There is a fee for all XT finishes other than 26- Satin Chrome.)

Available Technologies:

- X4
- XT (please see XT section of catalog for more details)
- Medeco B

How To Order Small Format Interchangeable Core

Medeco X4		LEVEL 1 – Patented Key Control
Cores Only	Part Number	Notes
6 Pin Small Format Interchangeable Core with Clip Retainer, Removable Front Plate	33600006 (P)	Pinned pricing includes master key system design and pinning, as well as two cut keys. Note: Conventional cylinders are available (KIK, Rim, Mortise, etc.) and can be easily integrated into an SFIC Master Key System
	33600006 (S)	
7 Pin Small Format Interchangeable Core with Clip Retainer, Removable Front Plate	33700006 (P)	
	33700006 (S)	

How to Order Medeco X4:

(P) = Pinned (S) = Sub-Assembled

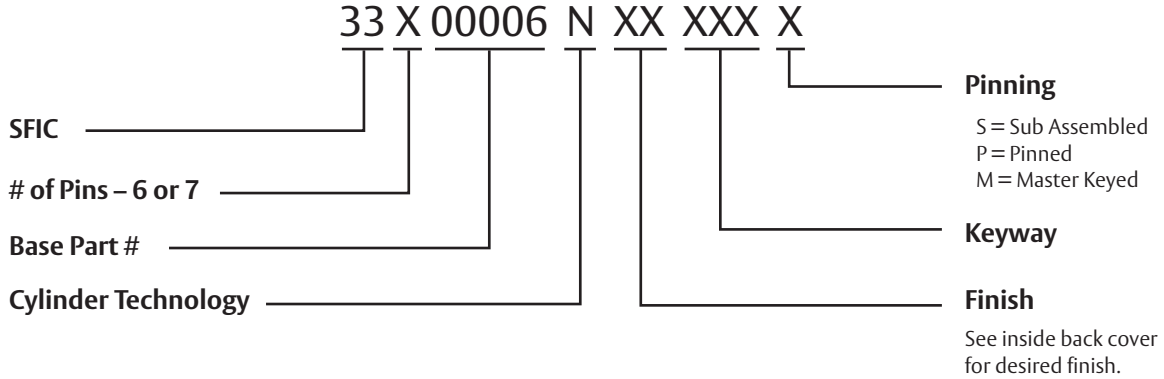

Medeco B		LEVEL 0 – Convenience
Cores Only	Part Number	Notes
6 Pin Small Format Interchangeable Core, Medeco B stamping	33-6B07X (P)	Pinned pricing includes master key system design and pinning, as well as two cut keys
	33-6B07X (S)	
6 Pin Small Format Interchangeable Core, no stamping	33-6B01X (P)	
	33-6B01X (S)	
7 Pin Small Format Interchangeable Core, Medeco B stamping	33-7B07X (P)	
	33-7B07X (S)	
7 Pin Small Format Interchangeable Core, no stamping	33-7B01X (P)	
	33-7B01X (S)	

How to Order Medeco B:

(P) = Pinned (S) = Sub-Assembled

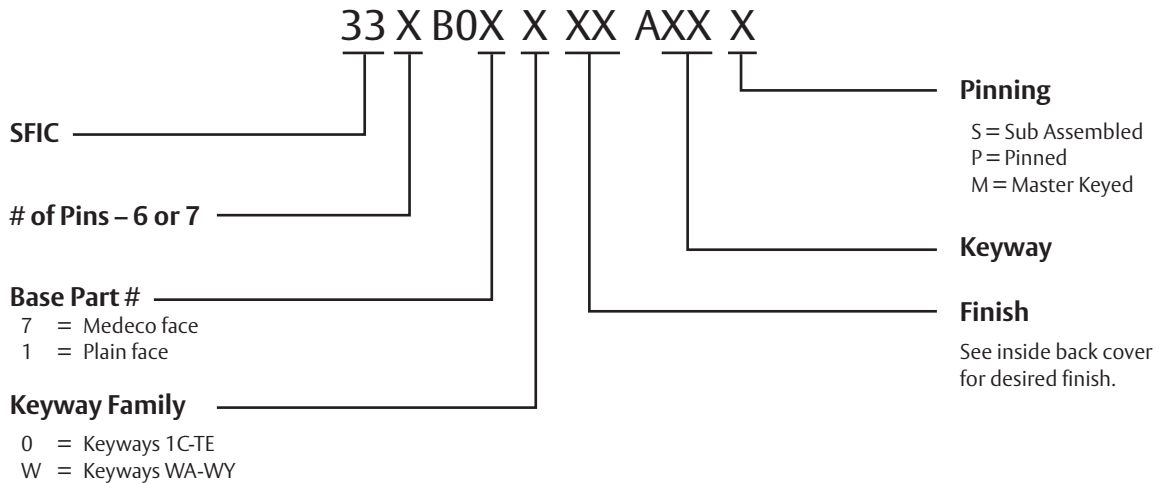

Small Format Interchangeable Core

Description		Part Number	Medeco B	X4	KeyMark
	Medeco X4 and KM 6 Pin SFIC	33600006 (P)		\$94.10	\$101.47
		33600006 (S)		\$77.60	\$84.97
	Medeco B 6 Pin SFIC, Medeco face plate, Alphabet and T series keyways	336B070 (P)	\$67.90		
		336B070 (S)	\$22.90		
	Medeco B 6 Pin SFIC, Medeco face plate, W series keyways	336B07W (P)	\$67.90		
		336B07W (S)	\$22.90		
	Medeco B 6 Pin SFIC, plain face plate, Alphabet and T Series Keyways	336B010 (P)	\$67.90		
		336B010 (S)	\$22.90		
	Medeco B 6 Pin SFIC, plain face plate, W Series Keyways	336B01W (P)	\$67.90		
		336B01W (S)	\$22.90		
	Medeco X4 and KM 7 Pin SFIC	33700006 (P)		\$94.10	\$101.47
		33700006 (S)		\$77.60	\$84.97
	Medeco B 7 Pin SFIC, Medeco face plate, Alphabet and T series keyways	337B070 (P)	\$67.90		
		337B070 (S)	\$22.90		
	Medeco B 7 Pin SFIC, Medeco face plate, W series keyways	337B07W (P)	\$67.90		
		337B07W (S)	\$22.90		
	Medeco B 7 Pin SFIC, plain face place, Alphabet and T Series Keyways	337B010 (P)	\$67.90		
		337B010 (S)	\$22.90		
	Medeco B 7 Pin SFIC, plain face plate, W Series Keyways	337B01W(P)	\$67.90		
		337B01W (S)	\$22.90		
	Medeco X4 and KM 6 Pin SFIC, Extended Plug Head	33600007 (P)		\$94.10	\$101.47
		33600007 (S)		\$77.60	\$84.97
	Small Format Interchangeable Core, Extended Plug Head	33700007 (P)		\$94.10	\$101.47
		33700007 (S)		\$77.60	\$84.97
	Specialty Sliding Door 7 Pin SFIC, Medeco X4 and KM	3370000S (P)		\$101.33	\$108.70
		3370000S (S)		\$84.83	\$92.20
	Medeco B 7 Pin SFIC for Showcase Lock, Medeco face plate	337B070S (P)	\$67.90		
		337B070S (S)	\$22.90		
	Medeco B 7 Pin SFIC for Showcase Lock, Medeco face plate, W series keyways	337B07WS (P)	\$67.90		
		337B07WS (S)	\$22.90		

(P) = Pinned (combined), (S) = Sub-assembled (uncombined)
 Surcharges for Master Keying, Custom Coining and Custom Stamping apply, see page 196.
 Refer to the XT and CLIQ Intelligent Key sections for format availability and pricing.

NOTE: Price includes \$45 adder for Medeco B pinned/master-pinned only.

SFIC Rim Cylinders

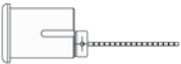
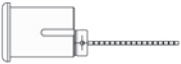
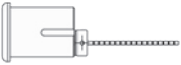
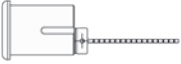
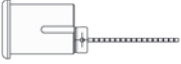
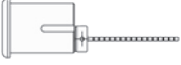
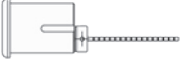





Description	Part Number	X4	KeyMark
 6 Pin SFIC with 1-1/4" Rim Assembly	33602032 (P)	\$148.75	\$160.91
	33602032 (S)	\$132.25	\$144.41
 6 Pin SFIC with 1-1/2" Rim Assembly	33602042 (P)	\$148.75	\$160.91
	33602042 (S)	\$132.25	\$144.41
 7 Pin SFIC with 1-1/2" Rim Assembly	33702042 (P)	\$148.75	\$160.91
	33702042 (S)	\$132.25	\$144.41
 7 Pin SFIC with Corbin Russwin® Master Ring Assembly	337020B2 (P)	\$148.75	\$160.91
	337020B2 (S)	\$132.25	\$144.41
 6 Pin SFIC with 1-1/2" Ext.Face Rim Assembly	33602033 K(P)	\$148.75	\$160.91
	33602033 K(S)	\$132.25	\$144.41
 6 Pin SFIC with 1-1/2" Ext.Face Rim Assembly	33602043 K(P)	\$148.75	\$160.91
	33602043 K(S)	\$132.25	\$144.41
 7 Pin SFIC with 1-1/2" Ext.Face Rim Assembly	33702043 K(P)	\$148.75	\$160.91
	33702043 K(S)	\$132.25	\$144.41

(P) = Pinned (combined)

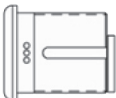
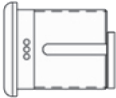
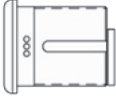
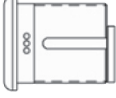
(S) = Sub-assembled (uncombined)

Surcharges for Master Keying, Custom Coining and Custom Stamping apply, see page 196.
Refer to the XT and CLIQ Intelligent Key sections for format availability and pricing.

SFIC Mortise Cylinders

Description	Part Number	X4	KeyMark
 6 Pin SFIC 1-1/4" Mortise Assembly	33602012 (P)	\$144.50	\$156.66
	33602012 (S)	\$128.00	\$140.16
 7 Pin SFIC 1-3/8" Mortise Assembly	33702022 (P)	\$144.50	\$156.66
	33702022 (S)	\$128.00	\$140.16
 7 Pin SFIC 1-3/8" Corbin® Jumbo Assembly	337020C2 (P)	\$144.50	\$156.66
	337020C2 (S)	\$128.00	\$140.16
 7 Pin SFIC 1-1/2" Mortise Cylinder Assembly	337020E2 (P)	\$144.50	\$156.66
	337020E2 (S)	\$128.00	\$140.16
 6 Pin SFIC 1-1/4" Ext. Face Mortise Assembly Medeco KM only	33602013 K(P)		\$156.66
	33602013 K(S)		\$140.16
 7 Pin SFIC 1-3/8" Ext. Face Mortise Assembly Medeco KM only	33702023 K(P)		\$156.66
	33702023 K(S)		\$140.16
 6 Pin SFIC 7/8" body length (1-3/8" overall) Tapered Head Mortise Assembly	33602052 (P)	\$144.50	\$156.66
	33602052 (S)	\$128.00	\$140.16
 6 Pin SFIC 1" body length (1-1/2" overall) Tapered Head Mortise Assembly (can accept 7 pin core)	33602062 (P)	\$144.50	\$156.66
	33602062 (S)	\$128.00	\$140.16
 6 Pin SFIC 7/8" body length (1-3/8" overall) Ext. Face Tapered Head Mortise Assembly	33602053 K(P)	\$144.50	\$156.66
	33602053 K(S)	\$128.00	\$140.16
 6 Pin SFIC 1" body length (1-1/2" overall) Ext. Face Tapered Head Mortise Assembly (can accept 7 pin core)	33602063 K(P)	\$144.50	\$156.66
	33602063 K(S)	\$128.00	\$140.16

(P) = Pinned (combined)

(S) = Sub-assembled (uncombined)

Surcharges for Master Keying, Custom Coining and Custom Stamping apply, see page 196.
Refer to the XT and CLIQ Intelligent Key sections for format availability and pricing.

SFIC Housings

Description	Part Number	Price
 6 Pin 1-1/4" Mortise Housing Only	33-076011	\$24.74
 6 or 7 Pin 1-3/8" Mortise Housing Only	33-076021	\$24.74
 7 Pin 1-1/2" SFIC Mortise Housing Only, (If using 6 Pin core spacer CP-160420 required)	33-076025	\$49.80
 7 Pin 1-3/8" Housing Only for Corbin® Russwin® Master Ring Cylinders*	33-076028	\$73.62
 6 Pin 7/8" Tapered Head Mortise Housing Only	33-076051	\$24.74
 6 or 7 Pin 1" Tapered Head Mortise Housing Only	33-076061	\$24.74
 6 Pin 1-1/2" Rim Cylinder Housing Only	33-07603H	\$24.73
 7 Pin 1 -1/2" Rim Cylinder Housing Only	33-07604H	\$24.73
 7 Pin Corbin® Jumbo Rim Housing Only	33-076048	\$73.62

Showcase Lock Housing

Description	Part Number	Price
Showcase lock for SFIC cylinder. Works with Medeco X4, Medeco XT, or Medeco B SFIC. SFIC sold separately.	33-07340	\$102.00

(P) = Pinned (combined)

(S) = Sub-assembled (uncombined)

Surcharges for Master Keying, Custom Coining and Custom Stamping apply, see page 196.
Refer to the XT and CLIQ Intelligent Key sections for format availability and pricing.

Medeco Maxum® Deadbolts

Commercial and Residential

Deadbolts are about strength. Just hold an ANSI/BHMA Grade 1 Maxum® deadbolt in your hand, and you know this is one tough hunk of protection. Medeco Maxum deadbolts are available in commercial style or residential trim, and offer superior physical protection attacks and break-ins. The difference between the commercial and residential deadbolt is that the residential version has a trim aesthetically-suited for homes.

They are also available as a single- or double-cylinder or with a “captive thumbturn.” The captive thumbturn converts the inside cylinder to a thumbturn for easy exit when the facility/home is occupied.

A quick conversion when the facility/home is not occupied returns it to double cylinder mode to guard against unauthorized entry. Medeco 4 (M4) Maxum® deadbolts are UL 437 listed, offering maximum protection with solid-brass construction, along with anti-drilling, picking and anti-prying features.



Maxum Commercial Deadbolt



Maxum Residential Deadbolt



Key Control

Patent-pending key control protects against unauthorized duplication of keys (Medeco 4).



Protection Against 3D Printing

A patent-pending movable element in the key deters unauthorized 3D printed copies of keys or blanks (M4).



Picking and Bumping Protection

M4 cylinders use cylinder side pins, a lift pin and a movable key element to engage a sidebar that prevents the key from turning until the elements are rotated and aligned in the correct position, protecting against bumping, picking and other attacks.



Certified Grade 1

BHMA certified Grade 1, passes to the highest standards in the industry (M4).



Drill Protection

Offers maximum protection with solid-brass construction and strategically placed drill pins.



Protection From Physical Attack

M4 Maxum Deadbolts are UL 437 Listed and stand up to prying, picking and other forms of physical attack.



Special Angle Cut Keys

Requires a special key cutting machine and access to Medeco specific blanks, available in a variety of restrictions to support every need.



Master Keying Capabilities

M4 deadbolts can be master keyed into a system that includes M4 and M4 BiLevel keys and cylinders. Extremely large systems are possible.

Technical Information:

- ANSI/BHMA A156.36 Grade 1 (M4) and UL 437 listed cylinders for high security (M4)
- Fits doors 1-3/8" to 2-1/2" thick
- Standard 2-1/8" crossbore and 1" edge bore (ANSI/BHMA A115.13 prep)

Warranty:

Warranted for two (2) years against manufacturer's defects. See the Medeco® Limited Warranty for full details.

Finishes:

Available in all standard finishes to match existing hardware.

Applications:

Ideal for a wide variety of commercial and residential applications where consistent quality, ease of use and installation are required.

- Office buildings
- Restaurants
- Hospitals
- Apartments
- Schools
- Retail outlets

Available Technologies:

Mechanical:

- M4/M4 BiLevel
- M³/M³ BiLevel
- X4

Intelligent Key:

- M³ CLIQ
- Classic CLIQ
- X4 CLIQ

Note: The 1-3/8" deadbolt also requires spacers.

How to Order:

<p>1</p> <p>11C601 base part # example</p> <p>Refer to pages 125-130 for descriptions and technical specifications to find the corresponding base part number.</p>	<p>2</p> <p>H technology</p> <p>H = M4 P = M4 BiLevel T = M³ J = M³ BiLevel S = M³ CLIQ W = Biaxial - = Original K = KM C = Classic CLIQ N = X4 M = X4 CLIQ</p>	<p>3</p> <p>05 finish</p> <p>Refer to the inside back cover of this catalog for finish options.</p> <p>Upcharge for split finish.</p>	<p>4</p> <p>M4 keyway</p> <p>Insert keyway if known or contact Customer Service for help.</p>	<p>5</p> <p>P pinning</p> <p>S = Sub-Assembled (Uncombined) N = Sub-assembled, No Side Pins (M4 only) No Slider (M3 only) P = Pinned (Combined) M = Master Keyed R = Master Keyed – blade and side pins (Medeco 4 only)</p>	<p>6</p> <p>624 Side Pin Code (M4 only)</p> <p>Insert side pin code if known or contact Customer Service for help.</p>
--	--	---	---	---	--

BUILD A MAXUM DEADBOLT BASE PART#

11XXXXXX

<p>Maxum Deadbolt _____</p> <p>Trim _____</p> <p>C = Commercial R = Residential</p> <p>Cylinder Type _____</p> <p>2 = Blank Plate 3 = LFIC (6 Pin) 4 = LFIC (Less Core) 5 = Medeco (5 Pin) 6 = Medeco (6 Pin) 7 = SFIC (Less Core) 8 = SFIC (6 Pin) [Only available in X4 and Keymark] 9 = SFIC (7 Pin) [Only available in X4 and Keymark]</p> <p>Function _____</p> <p>0 = Cylinder x Thumbturn 1 = Cylinder x Thumbturn (Classroom) 2 = Cylinder x Cylinder 3 = Cylinder x Cylinder (Captive) 4 = Cylinder x Plate (mounting screws on plate side) 5 = Dummy x Thumbturn 6 = Dummy x Cylinder 7 = Dummy x Plate (mounting screws on plate side) 8 = Plate x Thumbturn (mounting screws on thumbturn side) 9 = Plate x Cylinder (mounting screws on cylinder side) D = Dummy x Dummy P = Plate x Plate</p>	<p>Technology</p> <p>H = M4 P = M4 BiLevel T = M³ J = M³ BiLevel S = M³ CLIQ W = Biaxial - = Original K = KM (only available in SFIC prep) C = Classic CLIQ N = X4 (only available in SFIC prep) M = X4 CLIQ</p> <p>Bolt Option</p> <p>1 = 2-3/8" Backset, 1-1/8" Front 2 = 2-3/4" Backset, 1-1/8" Front 3 = 2-3/8" Backset, 1" Front 4 = 2-3/4" Backset, 1" Front 5 = 2-3/8" Backset, Round Front 6 = 2-3/4" Backset, Round Front L = Less Bolt Assembly</p>
---	--

For legacy technology pricing, call Customer Service or visit Medeco.com.

Single Cylinder Maxum Deadbolt – Commercial Trim

Description	Part Number	M4	M4 BiLevel	M3	M3 BiLevel	X4
Maxum Deadbolt Lock, Blank Plate Outside with Inside Thumbturn, 1-1/8" Faceplate, with bolt	11C28X	\$247.00				
Single Cylinder Maxum Deadbolt Lock, 1-1/8" Faceplate, with bolt	11C60X (P)	\$296.50	\$247.00	\$309.10	\$253.30	
	11C60X (S)	\$280.00	\$238.00	\$292.60	\$244.30	
Single Cylinder Maxum Deadbolt Lock, Less Bolt	11C60L (P)	\$211.95	\$162.45	\$224.55	\$168.75	
	11C60L (S)	\$195.45	\$153.45	\$208.05	\$159.75	
Single Cylinder Maxum Deadbolt Lock, Classroom Function, 1-1/8" Faceplate, with bolt	11C61X (P)	\$302.50		\$315.37		
	11C61X (S)	\$286.00		\$298.87		
Single Cylinder Maxum Deadbolt Lock, Classroom Function, Less Bolt	11C61L (P)	\$217.95		\$230.82		
	11C61L (S)	\$201.45		\$214.32		
Single Cylinder Maxum Deadbolt Lock, Classroom Function, 1-1/8" Faceplate, with bolt	11C61X (P)	\$302.50		\$315.37		
	11C61X (S)	\$286.00		\$298.87		
Single Cylinder Maxum Deadbolt Lock with Blank Plate Inside, 1-1/8" Faceplate, with bolt	11C64X (P)	\$290.50		\$302.83		
	11C64X (S)	\$274.00		\$286.33		
Single Cylinder Maxum Deadbolt Lock, with Blank Plate Outside, 1-1/8" Faceplate, with bolt	11C69X (P)	\$290.50		\$302.83		
	11C69X (S)	\$274.00		\$286.33		

LFIC Single Cylinder Maxum – Commercial Trim

Description	Part Number	M4	M4 BiLevel	M3	M3 BiLevel	X4
LFIC Single Cylinder Maxum Deadbolt Lock, Less Bolt	11C30L (P)	\$315.95		\$333.23		
	11C30L (S)	\$299.45		\$316.73		
LFIC Single Cylinder Maxum Deadbolt Lock, 1-1/8" Faceplate, with bolt	11C30X (P)	\$400.50		\$417.78		
	11C30X (S)	\$384.00		\$401.28		
LFIC Single Cylinder Maxum Deadbolt Lock Classroom Function, 1-1/8" Faceplate, with bolt	11C31X (P)	\$406.50		\$424.05		
	11C31X (S)	\$390.00		\$407.55		
LFIC Single Cylinder Maxum Deadbolt Lock Classroom Function, Less Bolt	11C31L (P)	\$321.95		\$339.50		
	11C31L (S)	\$305.45		\$323.00		
LFIC Single Cylinder Maxum Deadbolt Lock, Blank Inside, 1-1/8" Faceplate, with bolt	11C34X (P)	\$393.50		\$410.46		
	11C34X (S)	\$377.00		\$393.96		
LFIC Single Cylinder Maxum Deadbolt Lock, Blank Outside, 1-1/8" Faceplate *, with bolt	11C39X (P)	\$393.50		\$410.46		
	11C39X (S)	\$377.00		\$393.96		
LFIC Single Cylinder Maxum Deadbolt Lock, 1-1/8" Faceplate, Less Core, with bolt	11C40X	\$228.00		\$228.00		

SFIC Single Cylinder Maxum – Commercial Trim

Description	Part Number	M4	M4 BiLevel	M3	M3 BiLevel	X4
SFIC Single Cylinder Maxum Deadbolt Lock, 1-1/8" Faceplate, Less Core, with bolt	11C70X					\$226.66
SFIC Single Cylinder Maxum Deadbolt Lock, Classroom Function, 1-1/8" Faceplate, Less Core, with bolt	11C71X					\$225.00
SFIC Single Cylinder Maxum Deadbolt Lock, 1-1/8" Faceplate, 6 Pin SFIC Cylinder, with bolt	11C80X (P)					\$309.50
	11C80X (S)					\$293.00
SFIC Single Cylinder Maxum Deadbolt Lock, Classroom Funct., 1-1/8" Faceplate, 6 Pin SFIC Cyl. with bolt	11C81X (P)					\$315.50
	11C81X (S)					\$299.00

(P) = Pinned (combined)
 (S) = Sub-assembled (uncombined)
 Surcharges for Master Keying, Custom Coining and Custom Stamping apply, see page 196.
 Refer to the XT and CLIQ Intelligent Key sections for format availability and pricing.

SFIC Single Cylinder Maxum – Commercial Trim

Description	Part Number	M4	M4 BiLevel	M3	M3 BiLevel	X4
SFIC Single Cylinder Maxum Deadbolt Lock, Blank Inside, 1-1/8" Faceplate, 6 Pin SFIC Cylinder, with bolt	11C84X (P)					\$303.50
	11C84X (S)					\$287.00
SFIC Single Cylinder Maxum Deadbolt Lock, Blank Outside, 1-1/8" Faceplate, 6 Pin SFIC Cylinder *, with bolt	11C89X (P)					\$303.50
	11C89X (S)					\$287.00
SFIC Single Cylinder Maxum Deadbolt Lock, 1-1/8" Faceplate, 7 Pin SFIC Cylinder, with bolt	11C90X (P)					\$309.50
	11C90X (S)					\$293.00
SFIC Single Cylinder Maxum Deadbolt Lock, Classroom Function, 1-1/8" Faceplate, 7 Pin SFIC Cylinder, with bolt	11C91X (P)					\$315.50
	11C91X (S)					\$299.00
SFIC Single Cylinder Maxum Deadbolt Lock, Blank Inside, 1-1/8" Faceplate, 7 Pin SFIC Cylinder, with bolt	11C94X (P)					\$303.50
	11C94X (S)					\$287.00

Double Cylinder Maxum Deadbolt – Commercial Trim

Description	Part Number	M4	M4 BiLevel	M3	M3 BiLevel	X4
Double Cylinder Maxum Deadbolt Lock, 1-1/8" Faceplate, with bolt	11C62X (P)	\$407.00	\$335.90	\$423.83	\$344.31	
	11C62X (S)	\$374.00	\$317.90	\$390.83	\$326.31	
Double Cylinder Maxum Deadbolt Lock, Less Bolt	11C62L (P)	\$322.45	\$251.35	\$339.28	\$259.76	
	11C62L (S)	\$289.45	\$233.35	\$306.28	\$241.76	

Double Cylinder Captive Thumbturn Maxum – Commercial Trim

Description	Part Number	M4	M4 BiLevel	M3	M3 BiLevel	X4
Captive Double Cylinder Maxum Deadbolt Lock, Less Bolt, 1-3/4" – 2" door	11C63L (P)	\$375.45	\$311.40	\$394.67	\$321.01	
	11C63L (S)	\$342.45	\$278.40	\$361.67	\$288.01	
Captive Double Cylinder Maxum Deadbolt Lock, 1-1/8" Faceplate, 1-3/4" – 2" door, with bolt	11C63X (P)	\$460.00	\$380.95	\$479.21	\$390.56	
	11C63X (S)	\$427.00	\$362.95	\$446.21	\$372.56	
Captive Double Cylinder Maxum Deadbolt Lock, 1-1/8" Faceplate, 2-1/4" – 2-1/2" door, with bolt	11C63XT (P)	\$460.00	\$395.95	\$479.21	\$390.56	
	11C63XT (S)	\$427.00	\$362.95	\$446.21	\$372.56	
Captive Double Cylinder Maxum Deadbolt Lock, Less Bolt, 2-1/4" – 2-1/2" door	11C63LT (P)	\$375.45	\$311.40	\$394.67	\$321.01	
	11C63LT (S)	\$342.45	\$278.40	\$361.67	\$288.01	

LFIC Double Cylinder Maxum – Commercial Trim

Description	Part Number	M4	M4 BiLevel	M3	M3 BiLevel	X4
LFIC Double Cylinder Maxum Deadbolt Lock, 1" Faceplate, with bolt	11C32X (P)	\$617.00		\$643.28		
	11C32X (S)	\$584.00		\$610.28		
LFIC Double Cylinder Maxum Deadbolt Lock, Less Bolt	11C32L (P)	\$532.45		\$558.73		
	11C32L (S)	\$499.45		\$525.73		
LFIC Double Cylinder Maxum Deadbolt Lock, 1-1/8" Faceplate, Less Core, with bolt	11C42X	\$279.00		\$279.00		

SFIC Double Cylinder Maxum – Commercial Trim

Description	Part Number	M4	M4 BiLevel	M3	M3 BiLevel	X4
SFIC Double Cylinder Maxum Deadbolt Lock, 1-1/8" Faceplate, Less Core, with bolt	11C72X					\$264.00
SFIC Double Cylinder Maxum Deadbolt Lock, 1-1/8" Faceplate, 6 Pin Cylinder, with bolt	11C82X (P)					\$448.00
	11C82X (S)					\$415.00
SFIC Double Cylinder Maxum Deadbolt Lock, 1-1/8" Faceplate, 7 Pin Cylinder, with bolt	11C92X (P)					\$448.00
	11C92X (S)					\$415.00

(P) = Pinned (combined)

(S) = Sub-assembled (uncombined)

Surcharges for Master Keying, Custom Coining and Custom Stamping apply, see page 196.
Refer to the XT and CLIQ Intelligent Key sections for format availability and pricing.

Interchangeable Core Cylinders for Maxum® Deadbolts

Description	Part Number	M4	M4 BiLevel	M3	M3 BiLevel	X4
6 pin LFIC Cylinder	320201 (P)	\$192.50	\$104.92	\$200.42	\$108.88	\$134.35
	320201 (S)	\$176.00	\$95.92	\$183.92	\$99.88	\$117.85
6 Pin SFIC Cylinder	33600006 (P)					\$94.10
	33600006 (S)					\$77.60
7 Pin SFIC Cylinder	33700006 (P)					\$94.10
	33700006 (S)					\$77.60

Maxum Deadbolt Cylinder Assemblies

Description	Part Number	M4	M4 BiLevel	M3	M3 BiLevel	X4
5 Pin Outside Cylinder Assembly	110A00 (P)	\$159.50		\$165.94		
	110A00 (S)	\$143.00		\$149.44		
5 Pin Inside Cylinder Assembly	110A01 (P)	\$159.50		\$165.94		
	110A01 (S)	\$143.00		\$149.44		
5 Pin Outside Captive Cylinder Assembly	110A02 (P)	\$159.50		\$165.94		
	110A02 (S)	\$143.00		\$149.44		
5 Pin Inside Captive Cylinder Assembly	110A03 (P)	\$159.50		\$165.94		
	110A03 (S)	\$143.00		\$149.44		
6 Pin Outside Cylinder Assembly	110A04 (P)	\$159.50	\$130.55	\$165.94	\$133.77	
	110A04 (S)	\$143.00	\$121.55	\$149.44	\$124.77	
6 Pin Inside Cylinder Assembly	110A05 (P)	\$159.50	\$130.55	\$165.94	\$133.77	
	110A05 (S)	\$143.00	\$121.55	\$149.44	\$124.77	
6 Pin Outside Captive Cylinder Assembly	110A06 (P)	\$169.50		\$176.38		
	110A06 (S)	\$153.00		\$159.88		
6 Pin Inside Captive Cylinder Assembly	110A07 (P)	\$169.50		\$176.38		
	110A07 (S)	\$153.00		\$159.88		

Cylinder Housing & Plugs for Maxum Deadbolt

Description	Part Number	M4	M4 BiLevel	M3	M3 BiLevel	X4
LFIC Outside Cylinder Housing for Maxum Deadbolt Lock	110A08L	\$123.00				
LFIC Inside Cylinder Housing for Maxum Deadbolt Lock	110A09L	\$154.00				
6 Pin Plug for Maxum D.bolt (except Inside Captive Thumbturn)	1202800	\$64.90		\$67.82		
6 Pin Plug for Maxum Deadbolt Inside Captive Thumbturn	1202900	\$64.90		\$67.82		

Bolt Assemblies for Maxum® Deadbolt

Description	Part Number	M4	M4 BiLevel	M3	M3 BiLevel	X4
2-3/8" Maxum Bolt 1" X 2-1/4" Faceplate	110A1911	\$88.50				
2-3/8" Maxum Bolt 1 1/8" X 2-1/4" Faceplate	110A1912	\$88.50				
2-3/8" Maxum Drive-in Bolt (Available in 26 finish only)	110A1913	\$88.50				
2-3/4" Maxum Bolt 1" X 2-1/4" Faceplate	110A1921	\$88.50				
2-3/4" Maxum Bolt 1-1/8" X 2-1/4" Faceplate	110A1922	\$88.50				
2 -3/4" Maxum Drive-in Bolt (Available in 26 finish only)	110A1923	\$88.50				
5 Pack Round Front Assembly For Maxum Drive-In Bolt (Includes: CP-180961-26 and CP-011016-020)	94-0058-MED	\$195.00				
Round Front Assembly For Maxum Drive-In Bolt (Includes: CP-180961-26 and CP-011016-020)	94-0059	\$47.60				

(P) = Pinned (combined)

(S) = Sub-assembled (uncombined)

Surcharges for Master Keying, Custom Coining and Custom Stamping apply, see page 196.
Refer to the XT and CLIQ Intelligent Key sections for format availability and pricing.

Maxum Deadbolt Components

Description	Part Number	Price
6 Pin Length Deadbolt Lock Outside Dummy Cylinder	11-0A16	\$82.40
Residential Blank Inside Plate Assembly for Maxum® Deadbolt Lock	11-0A17	\$54.60
5 Pin Length Deadbolt Lock Outside Dummy Cylinder	11-0A18	\$82.40
Commercial Blank Inside Plate Assembly for Maxum® Deadbolt Lock	11-0A14	\$54.60
Residential Style Thumbturn To Fit On Captive Thumbturn Key (Original/Biaxial)	11-0A20	\$42.00
Residential Style Thumbturn To Fit On Captive Thumbturn Key (Medeco ³ /Medeco 4)	11-0A21	\$42.00
Commercial Thumbturn and Base Plate Assembly	11-0A12	\$106.00
Commercial Style Thumbturn To Fit On Captive Thumbturn Key (Medeco ³ /Medeco 4)	11-0018	\$42.00
Commercial Thumbturn & set screw	11-0A22	\$60.90
Residential Thumbturn & set screw	11-0A23	\$60.90
Residential Thumbturn and Base Plate Assembly	11-0A10	\$106.00
Commercial Style Thumbturn To Fit On Captive Thumbturn Key (Original/Biaxial)	11-0092	\$42.00
Thumbturn Trim Plate Package for Maxum Deadbolt Lock	94-0210	\$10.60
Inside Cylinder Trim Plate Package for Commercial Maxum® I/C Deadbolt Lock (includes CP-021090 & CP-180141)	94-0030	\$9.18
Spacer Rings for 1 3/8" Door for Maxum Deadbolt Lock (Package of 2)	94-0212	\$51.30
Inside Cylinder Trim Plate Package for Maxum Double Cylinder Deadbolt Lock (Includes CP-021090 & CP-180131)	94-0029	\$9.18
#8 x 2" FHWS Strike Box mounting screws	CP-010234-320	\$0.96
#8 x 3/4" comb. Wood/Machine S Bolt & Strike mounting screws	CP-010235-120-XX	\$0.96
Screw Package for 5 and 6 Pin Single Cylinder Maxum Deadbolt Lock	CP-011762	\$23.70
Screw Package for 5 Pin Double Cylinder Maxum Deadbolt Lock	CP-011763	\$23.70
Screw Package for 6 Pin Double Cylinder Maxum Deadbolt Lock	CP-011764	\$23.70
Screw Package for Blank x Thumbturn Maxum Deadbolt Lock	CP-011751	\$23.70
Screw Package for Blank x Cylinder Maxum Deadbolt Lock	CP-011767	\$23.70
Screw Package for Blank x Thumbturn Maxum Deadbolt Lock for 2 1/4" - 2 1/2" thick door	CP-011753	\$12.10
Screw Package for Blank x Cylinder Maxum Deadbolt Lock for 2-1/4" - 2-1/2" thick door	CP-011754	\$12.10
Screw Package for 6 Pin Classroom Function Maxum Deadbolt Lock	CP-011757	\$23.70
Collar for Maxum Residential Style Deadbolt Lock 5 Pin	CP-070691	\$84.80
Collar for Maxum Residential Style Deadbolt Lock 6 Pin	CP-070701	\$84.80

(P) = Pinned (combined)

(S) = Sub-assembled (uncombined)

Surcharges for Master Keying, Custom Coining and Custom Stamping apply, see page 196.
Refer to the XT and CLIQ Intelligent Key sections for format availability and pricing.

Maxum Deadbolt Components

Description	Part Number	Price
Collar for Maxum Commercial Style Deadbolt Lock (Inside & Outside)	CP-070711	\$84.80
Collar for Maxum Residential Style Deadbolt Lock Thick Door Captive Thumbturn 5 Pin	CP-070721	\$84.80
Collar for Maxum Residential Style Deadbolt Lock Thick Door Captive Thumbturn 6 Pin	CP-070731	\$84.80
Collar for Maxum Commercial Style Deadbolt Lock Thick Door Captive Thumbturn	CP-070741	\$84.80
Strike for Maxum Deadbolt Lock	CP-180061	\$21.60
Ball bearings (Allen head of mounting screws) .191" diameter silver	CP-250010	\$0.30
Ball bearings (tip of mounting screws) .202" diameter black	CP-250020	\$0.30
Strike Reinforcement Strike Box for Maxum Deadbolt Lock	CP-280620	\$7.22
Keyblank for Captive Thumbturn Key for Maxum Deadbolt 6 Pin, varies by Key Section (factory will supply correct part number)	KYB XX6605	\$15.00

Maxum® Deadbolt Tailpieces

Description	Part Number	Price
Thumbturn Tailpiece for Maxum Deadbolt lock for 1-3/4" – 2-1/2" thick door	CT-F42	\$9.44
Thumbturn Tailpiece for Classroom Function Maxum Deadbolt lock, 1-3/4" – 2" thick doors	CT-F43	\$9.44
Thumbturn Tailpiece for Classroom Function Maxum Deadbolt lock for doors 2-1/4" – 2-1/2" thick	CT-F44	\$9.44
Tailpiece for Maxum Deadbolt lock, outside cylinder, .532" length, for doors up to 1-3/4" thick	CT-Y60	\$3.55
Tailpiece for Maxum Deadbolt outside cylinder, 1.430" length for doors over 1-3/4" thick	CT-Y61	\$3.55

(P) = Pinned (combined)

(S) = Sub-assembled (uncombined)

Surcharges for Master Keying, Custom Coining and Custom Stamping apply, see page 196.
Refer to the XT and CLIQ Intelligent Key sections for format availability and pricing.

Single Cylinder Maxum Deadbolt – Residential Trim

Description	Part Number	M4	M4 BiLevel	M3	M3 BiLevel
5 Pin Single Cylinder Deadbolt, 1" Faceplate, 2-3/8" Backset	11R503 (P)	\$296.50	\$247.00	\$309.10	\$253.30
	11R503 (S)	\$280.00	\$238.00	\$292.60	\$244.30
5 Pin Single Cylinder Deadbolt, 1" Faceplate, 2-3/4" Backset	11R504 (P)	\$296.50	\$247.00	\$309.10	\$253.30
	11R504 (S)	\$280.00	\$238.00	\$292.60	\$244.30
6 Pin Single Cylinder Deadbolt, 1" Faceplate, 2-3/8" Backset	11R603 (P)	\$296.50	\$247.00	\$309.10	\$253.30
	11R603 (S)	\$280.00	\$238.00	\$292.60	\$244.30
6 Pin Single Cylinder Deadbolt, 1" Faceplate, 2-3/4" Backset	11R604 (P)	\$296.50	\$247.00	\$309.10	\$253.30
	11R604 (S)	\$280.00	\$238.00	\$292.60	\$244.30
Single Dummy Trim Deadbolt (5 Pin Length)	11R57L	\$225.11		\$225.11	
Single Dummy Trim Deadbolt (6 Pin Length)	11R67L	\$225.11		\$225.11	

Double Cylinder Maxum Deadbolt – Residential Trim

Description	Part Number	M4	M4 BiLevel	M3	M3 BiLevel
5 Pin Double Cylinder Deadbolt 1" Faceplate, 2-3/8" Backset	11R523 (P)	\$407.00	\$335.90	\$423.83	\$344.31
	11R523 (S)	\$374.00	\$317.90	\$390.83	\$326.31
5 Pin Double Cylinder Deadbolt 1" Faceplate, 2-3/4" Backset	11R524 (P)	\$407.00	\$335.90	\$423.83	\$344.31
	11R524 (S)	\$374.00	\$317.90	\$390.83	\$326.31
6 Pin Double Cylinder Deadbolt, 1" Faceplate, 2-3/8" Backset	11R623 (P)	\$407.00	\$335.90	\$423.83	\$344.31
	11R623 (S)	\$374.00	\$317.90	\$390.83	\$326.31
6 Pin Double Cylinder Deadbolt, 1" Faceplate, 2-3/4" Backset	11R624 (P)	\$407.00	\$335.90	\$423.83	\$344.31
	11R624 (S)	\$374.00	\$317.90	\$390.83	\$326.31
Double Dummy Trim Deadbolt (5 Pin Length)	11R5DL	\$300.11		\$300.11	
Double Dummy Trim Deadbolt (6 Pin Length)	11R6DL	\$300.11		\$300.11	

Double Cyl. Captive Thumbturn Maxum – Residential Trim

Description	Part Number	M4	M4 BiLevel	M3	M3 BiLevel
5 Pin Captive Thumbturn Double Cylinder Deadbolt, 2-3/8" Backset	11R533 (P)	\$460.00	\$380.95	\$479.21	\$390.56
	11R533 (S)	\$427.00	\$362.95	\$446.21	\$372.56
5 Pin Captive Thumbturn Double Cylinder Deadbolt, 2-3/4" Backset	11R534 (P)	\$460.00	\$380.95	\$479.21	\$390.56
	11R534 (S)	\$427.00	\$362.95	\$446.21	\$372.56
6 Pin Captive Thumbturn Double Cylinder Deadbolt, 1" Faceplate, 2-3/8" Backset	11R633 (P)	\$460.00	\$380.95	\$479.21	\$390.56
	11R633 (S)	\$427.00	\$362.95	\$446.21	\$372.56
6 Pin Captive Thumbturn Double Cylinder Deadbolt, 1" Faceplate, 2-3/4" Backset	11R634 (P)	\$460.00	\$380.95	\$479.21	\$390.56
	11R634 (S)	\$427.00	\$362.95	\$446.21	\$372.56

Cylinder Plugs for Maxum – Residential Deadbolts

Description	Part Number	M4	M3
6 pin plug for Maxum Residential Deadbolt (except inside captive thumbturn)	1202800	\$64.90	\$67.82
6 pin plug for Maxum Residential Deadbolt inside captive thumbturn	1202900	\$64.90	\$67.82
5 pin plug for Maxum Residential Deadbolt (except inside captive thumbturn)	1236200	\$71.10	\$74.30
5 pin plug for Maxum Residential Deadbolt inside captive thumbturn	1243400	\$64.90	\$67.82

(P) = Pinned (combined)

(S) = Sub-assembled (uncombined)

Surcharges for Master Keying, Custom Coining and Custom Stamping apply, see page 196.
Refer to the XT and CLIQ Intelligent Key sections for format availability and pricing.

All Weather Padlocks

The Medeco All Weather Padlock (AWP) offers the highest level of severe weather protection. The body is solid 303 stainless steel and is available with either stainless steel or boron shackles. A weatherproof cylinder seal cap, attached by a stainless steel cable, seals the cylinder from harsh environments. Multiple mechanical and Intelligent Key technologies are available.

The AWP is not only weatherproof, it is also a high security padlock when a Medeco 4 (M4) cylinder is included. M4 cylinders provide the benefit of patented key control and resistance to surreptitious attacks while both the Medeco CLIQ and Medeco XT cylinders add sophisticated audit and control features.



Patented Key Control

Protects against unauthorized duplication of keys.



Special Angled Key Cuts (HS Cylinder Models)

Requires a special key cutting machine and access to Medeco specific blanks, available in a variety of restrictions to support every need.



Can Be Master Keyed

Medeco can be master keyed into a system containing M4 or X4 mechanical as well as M³ CLIQ or XT Intelligent Key systems.



Protection From Shackle Attack

Hardened boron alloy steel shackles (5/16" and 7/16" diameters) provide strong resistance against cutting, sawing and prying. Available in both 1-7/8" and 2-3/8" or 1" and 2-1/2" lengths.



Protection From Physical Attack

M4 cylinders are UL 437 listed and resist drilling, forcing and other forms of physical attack.



Picking and Bumping Protection

M4 cylinders use cylinder side pins, a lift pin and a movable key element to engage a sidebar that prevents the key from turning until the elements are rotated and aligned in the correct position, protecting against bumping, picking and other attacks.

Benefits:

- 300 Series, solid, machined stainless steel body resists attack and corrosion
- 5/16" and 7/16" diameter, stainless steel and boron shackles
- 1-7/8", 2-3/8", 2", and 2-1/2" shackle lengths
- Padlocks are shipped with a weather proof cylinder seal cap attached by a stainless steel cable
- IP68 Environmental protection rating for harsh environments
- ASTM F883-13 rating for tensile pull, shock, plug pull, plug torque, cutting, and corrosion (salt fog)
- Vibration tested per MIL-STD-202G, method 201A
- Key retaining cylinder design
- O-ring sealed cap, cylinder, and shackles resist grime and water penetration at low temperatures

Applications:

The AWP series is designed for installations requiring service in harsh weather conditions. Applications include outdoor perimeter fencing, gates, tool cabinets, storage, and transportation cargo containers. Ideal for Intelligent Key cylinders in outdoor harsh environments.

Warranty:

Warranted for two (2) years against manufacturer's defects. See the Medeco limited warranty for full details.

Finishes:

The padlock comes in a standard industrial stainless steel finish and the cylinders are furnished in the satin brass finish.

Available Key Technologies:

Mechanical:

- M4/M4 BiLevel
- M³/M³ BiLevel
- X4

- Medeco Biaxial*
- * Medeco Biaxial requires extended throat key blank

Intelligent Key:

- Medeco XT
- M³ CLIQ
- X4 CLIQ

How to Order AWP Series Padlocks:

Complete part numbers are required for all orders. To determine the correct part number, fill in the "Xs" in sequential order.

1

5005511 base part # example

Refer to pages 133-134 for descriptions and technical specifications to find the corresponding base part number.

2

H technology

H = M4
P = M4 BiLevel
T = M³
J = M³ BiLevel
S = M³ CLIQ
W = Biaxial
N = X4
M = X4 CLIQ
G = XT

3

26 finish

26 finish only.

4

M4 keyway

Insert keyway if known
or contact Customer
Service for help.

5

P pinning

S = Sub-Assembled
(Uncombined)
N = Sub-assembled,
– No side pins
(M4 only)
– No slider
(M3 only)
P = Pinned
(Combinated)
M = Master Keyed
R = Master Keyed
– blade and side pins
(M4 only)

6

624 side pin code

(M4 only)
Insert side pin code
if known or contact
Customer Service
for help.

BUILD AN AWP SERIES PADLOCK BASE PART

50 X 05XXX

Prefix

Shackle (Diameter),
Material, Clearance

511 = 5/16", SS, 1-7/8"
521 = 5/16", SS, 2-3/8"
531 = 5/16", Boron, 1-7/8"
541 = 5/16", Boron, 2-3/8"
711 = 7/16", SS, 2"
721 = 7/16", SS, 2-1/2"
731 = 7/16", Boron, 2"
741 = 7/16", Boron, 2-1/2"

*AWP with mechanical cylinder requires the use of extended shoulder key blanks.

Medeco³ use KY3366XX or KY3466XX.
Original/Biaxial use KY1866XX or KY2266XX.

For legacy technology pricing, call Customer Service or visit Medeco.com.

All Weather Padlock with 5/16" Shackle*

Description	Part Number	M4	M3	X4
AWP 5/16" diameter SS shackle, 1-7/8" clearance	5005511 (P)	\$296.50	\$309.10	\$279.53
	5005511 (S)	\$280.00	\$292.60	\$263.03
AWP 5/16" diameter SS shackle, 2-3/8" clearance	5005521 (P)	\$301.50	\$314.33	\$284.53
	5005521 (S)	\$285.00	\$297.83	\$268.03
AWP 5/16" diameter Boron shackle, 1-7/8" clearance	5005531 (P)	\$296.50	\$309.10	\$279.53
	5005531 (S)	\$280.00	\$292.60	\$263.03
AWP 5/16" diameter Boron shackle, 2-3/8" clearance	5005541 (P)	\$301.50	\$314.33	\$284.53
	5005541 (S)	\$285.00	\$297.83	\$268.03

All Weather Padlock with 7/16" Shackle*

Description	Part Number	M4	M3	X4
AWP 7/16" diameter SS shackle, 2" clearance	5005711 (P)	\$296.50	\$309.10	\$279.53
	5005711 (S)	\$280.00	\$292.60	\$263.03
AWP 7/16" diameter SS shackle, 2-1/2" clearance	5005721 (P)	\$301.50	\$314.33	\$284.53
	5005721 (S)	\$285.00	\$297.83	\$268.03
AWP 7/16" diameter Boron shackle, 2" clearance	5005731 (P)	\$296.50	\$309.10	\$279.53
	5005731 (S)	\$280.00	\$292.60	\$263.03
AWP 7/16" diameter Boron shackle, 2-1/2" clearance	5005741 (P)	\$301.50	\$314.33	\$284.53
	5005741 (S)	\$285.00	\$297.83	\$268.03

*AWP with mechanical cylinder requires the use of extended shoulder key blanks.

Medeco³ use KY3366XX or KY3466XX.
Original/Biaxial use KY1866XX or KY2266XX.

All Weather Padlock - No Cylinder

Description	Part Number	Price
AWP 5/16" dia SS shackle, Less Cyl, 1-7/8" clearance	50-0551L	\$219.00
AWP 5/16" dia SS shackle, Less Cyl, 2-3/8" clearance	50-0552L	\$226.00
AWP 5/16" dia Boron shackle, Less Cyl, 1-7/8" clearance	50-0553L	\$219.00
AWP 5/16" dia Boron shackle, Less Cyl, 2-3/8" clearance	50-0554L	\$226.00
AWP 5/16" dia SS shackle, Less Cyl, 4" clearance	50-0555L	\$236.00
AWP 7/16" dia SS shackle, Less Cyl, 2" clearance	50-0571L	\$219.00
AWP 7/16" dia SS shackle, Less Cyl, 2-1/2" clearance	50-0572L	\$226.00
AWP 7/16" dia Boron shackle, Less Cyl, 2" clearance	50-0573L	\$219.00
AWP 7/16" dia Boron shackle, Less Cyl, 2-1/2" clearance	50-0574L	\$226.00

All Weather Padlock Cylinders

Description	Part Number	M4	M3	X4
6 Pin Cylinder, KIK type for AWP Series Padlock (26 finish only)	510800 (P)	\$77.40	\$80.14	\$60.55
	510800 (S)	\$60.90	\$63.64	\$44.05

Components for All Weather Padlocks

Description	Part Number	Price
Thumbturn Cap Replacement Kit	94-0316	\$31.50
5/16" AWP O-ring Seal Kit	94-0317-516	\$6.28
7/16" AWP O-ring Seal Kit	94-0317-716	\$6.28
Wire Assembly Spacer	CP-160910	\$1.28
Wire Assembly	CP-287720	\$6.38
Seal Installation Tool	94-0318	\$126.00
Wire Assembly Screw	CP-014213-061	\$1.28
Set Screw	CP-014642-591	\$1.28
Shackle Locking Balls	CP-250180	\$2.55
Allen Wrench 2.5 mm	CP-287770	\$2.55

Shackles for All Weather Padlocks

Description	Boron Alloy Steel		Stainless Steel	
	Part Number	Price	Part Number	Price
Standard Shackle for AWP Padlock, 1-7/8" Shackle Clearance x 5/16" Diameter	CP-144270	\$13.20	CP-144230	\$19.80
Extra Length Shackle for AWP Padlock, 2-3/8" Shackle Clearance x 5/16" Diameter	CP-144280	\$16.00	CP-144240	\$22.20
Standard Shackle for AWP Padlock, 2" Shackle Clearance x 7/16" Diameter	CP-144290	\$16.00	CP-144250	\$22.20
Extra Length Shackle for AWP Padlock, 2-1/2" Shackle Clearance x 7/16" Diameter	CP-144300	\$17.70	CP-144260	\$24.40
5/16" dia, SS, shackle for AWP, 4" clearance			CP-145040	\$24.60

System Series Padlocks

The Medeco® System Series padlock offers a high security solution for a multitude of applications and is available in two distinctive body styles, an indoor/outdoor weather resistant design or with a shrouded shackle. Both models utilize a boron alloy steel shackle which provides protection against cutting and increased tensile strength to resist pulling attacks. The boron alloy steel also ensures that the shackle has an exceptional degree of ductility and is not brittle. The cylinder itself uses hardened, stainless steel inserts to provide the ultimate defense against drilling, pulling and other forms of vandal attack. All Medeco 4 (M4) keys and locks are protected under patent, trademark, and copyright laws. M4 keys may only be duplicated by Medeco® or by a Medeco® authorized sales outlet, and only at your request.



Patented Key Control

Protects against unauthorized duplication of your keys.



Protection From Physical Attack

M4 padlock cylinders are UL 437 listed and stand up to drilling, picking and other forms of physical attack.



Proprietary Deadlocking Shackle

Boron alloy steel shackles protect against cutting and pulling attacks.



Can Be Master Keyed

Medeco System Series Padlocks can be master keyed into a system containing M4 and M4 BiLevel, X4, and the CLIQ Intelligent Key system.



Available in Intelligent Key System

System Series Padlocks are also available with the Medeco CLIQ Intelligent Key system for Loss & Liability control.



Special Angle Cut Keys

Requires a special key cutting machine and access to Medeco specific blanks, available in a variety of restrictions to support every need.



Picking and Bumping Protection

M4 cylinders use cylinder side pins, a lift pin and a movable key element to engage a sidebar that prevents the key from turning until the elements are rotated and aligned in the correct position, protecting against bumping, picking and other attacks.

Technical Features:

- Available with either a 5/16 inch or a 7/16 inch shackle diameter.
- Available in Indoor/Outdoor weather resistant design or with a shrouded shackle.
- Extended shackles available for Indoor/Outdoor padlocks only.
- The shrouded shackle design provides extra shackle protection against cutting attacks.
- All Medeco® cylinders are constructed of durable machined brass components, designed to last the life of your equipment.
- Boron alloy steel shackle which protects against cutting and pulling attacks.
- Available in a variety of different shackle lengths.

Applications:

Used in a variety of different indoor or outdoor applications where high security and key control are a primary concern.

Warranty:

Warranted for two (2) years against manufacturer's defects. See the Medeco® limited warranty for full details.

Finishes:

The padlock comes in a standard black body cover and the cylinders are furnished in satin brass finish.

Available Key Technologies:

Mechanical:

- M4
- M³/M³ BiLevel
- X4

Intelligent Key:

- M³ CLIQ
- Classic CLIQ
- Medeco XT
- X4 CLIQ

How to Order System Series Padlocks:

Complete part numbers are required for all orders. To determine the correct part number, fill in the "Xs" in sequential order.

1

5451500 base part # example

Refer to pages 137-139 for descriptions and technical specifications to find the corresponding base part number.

2

H technology

H = M4
P = M4 BiLevel
T = M³
J = M³ BiLevel
S = M³ CLIQ
W = Biaxial
N = X4
M = X4 CLIQ
G = XT

3

06 finish

Insert 06 for
Satin Brass finish.

*See inside back cover
of the catalog for
all finish options.*

4

M4 keyway

Insert keyway if known
or contact Customer
Service for help.

5

P pinning

S = Sub-Assembled
(Uncombined)
N = Sub-assembled,
– No side pins
(M4 only)
– No slider
(M3 only)
P = Pinned
(Combinated)
M = Master Keyed
R = Master Keyed
– blade and side pins
(M4 only)

6

624 side pin code

(M4 only)

Insert side pin code
if known or contact
Customer Service
for help.

BUILD A SYSTEM SERIES PADLOCK BASE PART

54XXXX X X

Prefix

Shackle (Diameter), Feature, Clearance

315 = 5/16" Diameter, Weather, 1-1/8" SFIC
31F = 5/16" Diameter, Weather, 2-3/8" SFIC
335 = 5/16" Diameter, Weather, 1-1/8" SFIC 7 Pin
33F = 5/16" Diameter, Weather, 2-3/8" SFIC 7 Pin
515 = 5/16" Diameter, Weather, 1-1/8" KIK
51F = 5/16" Diameter, Weather, 2-3/8" KIK
525 = 5/16" Diameter, Shrouded, 3/4" KIK
615 = 5/16" Diameter, Weather, 1-1/8" LFIC
61F = 5/16" Diameter, Weather, 2-3/8" LFIC
715 = 7/16" Diameter, Weather, 1-3/8" KIK
71F = 7/16" Diameter, Weather, 1-7/8" KIK
725 = 7/16" Diameter, Shrouded, 3/4" KIK

Standard Options

Blank = None
T = Thick Head (SFIC Only)

Shackle Material

0 = Boron Alloy Steel
1 = Stainless Steel

Key Function

0 = Non-Key Retaining
K = Less Cylinder (Key Retaining)
L = Less Cylinder (Non-Key Retaining)
R = Key Retaining

For legacy technology pricing, call Customer Service or visit Medeco.com.

Indoor/Outdoor Padlock, 5/16" Shackle -KIK

Description	Part Number	M4	M4 BiLevel	M3	M3 BiLevel	X4
Indoor/Outdoor Padlock, Non-Key Retaining, 1-1/8" Shackle Clearance, With Cylinder	5451500 (P)	\$217.50	\$152.18	\$226.54	\$156.70	\$198.57
	5451500 (S)	\$201.00	\$143.18	\$210.04	\$147.70	\$182.07
Indoor/Outdoor Padlock, Key Retaining, 1-1/8" Shackle Clearance, With Cylinder	54515R0 (P)	\$217.50	\$152.18	\$226.54	\$156.70	\$198.57
	54515R0 (S)	\$201.00	\$143.18	\$210.04	\$147.70	\$182.07
Indoor/Outdoor Padlock, Non-Key Retaining, 2-3/8" Shackle Clearance, With Cylinder	5451F00 (P)	\$221.50	\$156.18	\$230.72	\$160.79	\$202.57
	5451F00 (S)	\$205.00	\$147.18	\$214.22	\$151.79	\$186.07
Indoor/Outdoor Padlock, Key Retaining, 2-3/8" Shackle Clearance, With Cylinder	5451FR0 (P)	\$221.50	\$156.18	\$230.72	\$160.79	\$202.57
	5451FR0 (S)	\$205.00	\$147.18	\$214.22	\$151.79	\$186.07
Indoor/Outdoor Padlock, Key Retaining, 1-1/8" Shackle Clearance, Less Cylinder	54515K0	\$73.16				
Indoor/Outdoor Padlock, Non-Key Retaining, 1-1/8" Shackle Clearance, Less Cylinder	54515L0	\$73.16				
Indoor/Outdoor Padlock, Key Retaining, 2-3/8" Shackle Clearance, Less Cylinder	5451FK0	\$77.16				
Indoor/Outdoor Padlock, Non-Key Retaining, 2-3/8" Shackle Clearance, Less Cylinder	5451FL0	\$77.16				

Indoor/Outdoor Padlock, 5/16" Shackle -6 Pin LFIC

Description	Part Number	M4	M4 BiLevel	M3	M3 BiLevel
Indoor/Outdoor Padlock, Non-Key Retaining, 1-1/8" Shackle Clearance, With Cylinder	5461500 (P)	\$297.50	\$202.22	\$310.14	\$208.54
	5461500 (S)	\$281.00	\$193.22	\$293.64	\$199.54
Indoor/Outdoor Padlock, Key Retaining, 1-1/8" Shackle Clearance, With Cylinder	54615R0 (P)	\$297.50	\$202.22	\$310.14	\$208.54
	54615R0 (S)	\$281.00	\$193.22	\$293.64	\$199.54
Indoor/Outdoor Padlock, Non-Key Retaining, 2-3/8" Shackle Clearance, With Cylinder	5461F00 (P)	\$305.50	\$210.22	\$318.50	\$216.72
	5461F00 (S)	\$289.00	\$201.22	\$302.00	\$207.72
Indoor/Outdoor Padlock, Key Retaining, 2-3/8" Shackle Clearance, With Cylinder	5461FR0 (P)	\$305.50	\$210.22	\$318.50	\$216.72
	5461FR0 (S)	\$289.00	\$201.22	\$302.00	\$207.72
Indoor/Outdoor Padlock, Key Retaining, 1-1/8" Shackle Clearance, Less Cylinder	54615K0	\$76.77			
Indoor/Outdoor Padlock, Non-Key Retaining, 1-1/8" Shackle Clearance, Less Cylinder	54615L0	\$76.77			
Indoor/Outdoor Padlock, Key Retaining, 2-3/8" Shackle Clearance, Less Cylinder	5461FK0	\$84.77			
Indoor/Outdoor Padlock, Non-Key Retaining, 2-3/8" Shackle Clearance, Less Cylinder	5461FL0	\$84.77			

(P) = Pinned (combined)

(S) = Sub-assembled (uncombined)

Surcharges for Master Keying, Custom Coining and Custom Stamping apply, see page 196.
Refer to the XT and CLIQ Intelligent Key sections for format availability and pricing.

Indoor/Outdoor Padlock, 5/16" Shackle -6 Pin SFIC

Description	Part Number	X4
Indoor/Outdoor Padlock, Non-Key Retaining, 1-1/8" Shackle Clearance, With Cylinder	5431500 (P)	\$186.57
	5431500 (S)	\$170.07
Indoor/Outdoor Padlock, Key Retaining, 1-1/8" Shackle Clearance, With Cylinder	54315R0 (P)	\$186.57
	54315R0 (S)	\$170.07
Indoor/Outdoor Padlock, Non-Key Retaining, 2-3/8" Shackle Clearance, With Cylinder	5431F00 (P)	\$192.57
	5431F00 (S)	\$176.07
Indoor/Outdoor Padlock, Key Retaining, 2-3/8" Shackle Clearance, With Cylinder	5431FR0 (P)	\$192.57
	5431FR0 (S)	\$176.07

Indoor/Outdoor Padlock, 5/16" Shackle -7 Pin SFIC

Description	Part Number	X4
Indoor/Outdoor Padlock, Non-Key Retaining, 1-1/8" Shackle Clearance, With Cylinder	5433500 (P)	\$186.57
	5433500 (S)	\$170.07
Indoor/Outdoor Padlock, Key Retaining, 1-1/8" Shackle Clearance, With Cylinder	54335R0 (P)	\$186.57
	54335R0 (S)	\$170.07
Indoor/Outdoor Padlock, Non-Key Retaining, 2-3/8" Shackle Clearance, With Cylinder	5433F00 (P)	\$192.57
	5433F00 (S)	\$176.07
Indoor/Outdoor Padlock, Key Retaining, 2-3/8" Shackle Clearance, With Cylinder	5433FR0 (P)	\$192.57
	5433FR0 (S)	\$176.07

Indoor/Outdoor Padlock, 5/16" Shackle -Less SFIC

Description	Part Number	Price
Indoor/Outdoor Padlock, Key Retaining, 1-1/8" Shackle Clearance, Less Cylinder	54315K0	\$74.78
Indoor/Outdoor Padlock, Non-Key Retaining, 1-1/8" Shackle Clearance, Less Cylinder	54315L0	\$74.78
Indoor/Outdoor Padlock, Key Retaining, 2-3/8" Shackle Clearance, Less Cylinder	5431FK0	\$80.78
Indoor/Outdoor Padlock, Non-Key Retaining, 2-3/8" Shackle Clearance, Less Cylinder	5431FL0	\$80.78

(P) = Pinned (combined)

(S) = Sub-assembled (uncombined)

Surcharges for Master Keying, Custom Coining and Custom Stamping apply, see page 196.
Refer to the XT and CLIQ Intelligent Key sections for format availability and pricing.

Indoor/Outdoor Padlock, 7/16" Shackle -KIK

Description	Part Number	M4	M4 BiLevel	M3	M3 BiLevel	X4
Indoor/Outdoor Padlock, Non-Key Retaining, 1-3/8" Shackle Clearance, With Cylinder	5471500 (P)	\$251.50	\$186.18	\$262.07	\$191.47	\$232.57
	5471500 (S)	\$235.00	\$177.18	\$245.57	\$182.47	\$216.07
Indoor/Outdoor Padlock, Key Retaining, 1-3/8" Shackle Clearance, With Cylinder	54715R0 (P)	\$251.50	\$186.18	\$262.07	\$191.47	\$232.57
	54715R0 (S)	\$235.00	\$177.18	\$245.57	\$182.47	\$216.07
Indoor/Outdoor Padlock, Non-Key Retaining, 1-7/8" Shackle Clearance, With Cylinder	5471F00 (P)	\$257.50	\$192.18	\$268.35	\$197.60	\$238.57
	5471F00 (S)	\$241.00	\$183.18	\$251.84	\$188.60	\$222.07
Indoor/Outdoor Padlock, Key Retaining, 1-7/8" Shackle Clearance, With Cylinder	5471FR0 (P)	\$257.50	\$192.18	\$268.35	\$197.60	\$238.57
	5471FR0 (S)	\$241.00	\$183.18	\$251.84	\$188.60	\$222.07
Indoor/Outdoor Padlock, Key Retaining, 1-3/8" Shackle Clearance, Less Cylinder	54715K0	\$107.16				
Indoor/Outdoor Padlock, Non-Key Retaining, 1-3/8" Shackle Clearance, Less Cylinder	54715L0	\$107.16				
Indoor/Outdoor Padlock, Key Retaining, 1-7/8" Shackle Clearance, Less Cylinder	5471FK0	\$113.16				
Indoor/Outdoor Padlock, Non-Key Retaining, 1-7/8" Shackle Clearance, Less Cylinder	5471FL0	\$113.16				

Shrouded Padlock, 5/16" Shackle - KIK

Description	Part Number	M4	M4 BiLevel	M3	M3 BiLevel	X4
Shrouded Padlock, Non-Key Retaining, 3/4" Shackle Clearance, With Cylinder	5452500 (P)	\$245.50	\$180.18	\$255.81	\$185.33	\$226.57
	5452500 (S)	\$229.00	\$171.18	\$239.31	\$176.33	\$210.07
Shrouded Padlock, Key Retaining, 3/4" Shackle Clearance, With Cylinder	54525R0 (P)	\$245.50	\$180.18	\$255.81	\$185.33	\$226.57
	54525R0 (S)	\$229.00	\$171.18	\$239.31	\$176.33	\$210.07
Shrouded Padlock, Key Retaining, 3/4" Shackle Clearance, Less Cylinder	54525K0	\$101.16				
Shrouded Padlock, Non-Key Retaining, 3/4" Shackle Clearance, Less Cylinder	54525L0	\$101.16				

Shrouded Padlock, 7/16" Shackle - KIK

Description	Part Number	M4	M4 BiLevel	M3	M3 BiLevel	X4
Shrouded Padlock, Non-Key Retaining, 3/4" Shackle Clearance, With Cylinder	5472500 (P)	\$300.50	\$235.18	\$313.28	\$241.57	\$281.57
	5472500 (S)	\$284.00	\$226.18	\$296.78	\$232.57	\$265.07
Shrouded Padlock, Key Retaining, 3/4" Shackle Clearance, With Cylinder	54725R0 (P)	\$300.50	\$235.18	\$313.28	\$241.57	\$281.57
	54725R0 (S)	\$284.00	\$226.18	\$296.78	\$232.57	\$265.07
Shrouded Padlock, Key Retaining, 3/4" Shackle Clearance, Less Cylinder	54725K0	\$156.16				
Shrouded Padlock, Non-Key Retaining, 3/4" Shackle Clearance, Less Cylinder	54725L0	\$156.16				

(P) = Pinned (combined)

(S) = Sub-assembled (uncombined)

Surcharges for Master Keying, Custom Coining and Custom Stamping apply, see page 196.
Refer to the XT and CLIQ Intelligent Key sections for format availability and pricing.

50 and 52 Series Brass Body Padlocks

The Medeco 50 Series and 52 Series brass padlocks are available in two versions. The 50 Series Padlock is available with a removable cylinder or interchangeable core. The 52 Series Padlock is designed to be keyed with Medeco's 60 Series cam locks and switch locks.

Both padlocks can accept cylinders and cores which are UL listed and virtually pickproof and drillproof. Mechanical cylinders provide the benefit of patented key control and resistance to physical attacks. The padlock cases are constructed of brass with stainless steel shackles for corrosion protection or hardened steel for protection against sawing.



Patented Key Control

Protects against unauthorized duplication of keys.



Special Angled Key Cuts

Requires a special key cutting machine and access to Medeco specific blanks, available in a variety of restrictions to support every need.



Can Be Master Keyed

50 and 52 Series Padlocks can be master keyed into the respective key technologies listed below.



Protection From Shackle Attack

The hardened boron alloy steel shackles provide strong resistance against cutting, sawing and prying. The stainless steel shackle protect against corrosion.



Protection From Physical Attack

M4 cylinders are UL 437 listed and resists drilling, picking and other forms of physical attack.



Picking and Bumping Protection

M4 cylinders use cylinder side pins, a lift pin and a movable key element to engage a sidebar that prevents the key from turning until the elements are rotated and aligned in the correct position, protecting against bumping, picking and other attacks.

Benefits:

- Optional dust cover protects keyway of cylinder from weather conditions
- Available keyed differently, keyed alike, or master keyed to your specific needs
- 50 Series and 52 Series padlocks are available in the non-key retained or key retained functions.
- Toe and heel deadbolt locking action
- The chain and clevis, designed for a more permanent attachment, are constructed of carbon steel with a zinc plating

Applications:

Medeco 50 and 52 Series padlocks can be used in a variety of indoor or outdoor applications including industrial safekeeping, perimeter gates, cargo vehicles, vending machines, gun cabinets, and more.

Warranty:

Warranted for two (2) years against manufacturer's defects. See the Medeco limited warranty for full details.

Finishes:

- 50 Series – Satin Brass (06) only
- 52 Series – Satin Chrome (26) only

50 Series Available Key Technologies:

Mechanical:

- M4
- M³
- X4 (LFIC only)
- Original
- Biaxial

Intelligent Key:

- M³ CLIQ (LFIC only)

52 Series Available Key Technologies:

Mechanical:

- M³
- Original
- Biaxial

How to Order a 50 Series Padlock:

Complete part numbers are required for all orders. To determine the correct part number, fill in the “Xs” in sequential order.

1

50022010 base part # example

Refer to pages 143 for descriptions and technical specifications to find the corresponding base part number.

<div style="text-align: center; font-weight: bold; font-size: 24px; margin-bottom: 10px;">2</div> <div style="text-align: center; font-weight: bold; font-size: 24px; margin-bottom: 10px;">H</div> <div style="text-align: center; font-weight: bold; margin-bottom: 10px;">technology</div> <p>H = M4 T = M³ W = Biaxial - = Original S = M³ CLIQ</p>	<div style="text-align: center; font-weight: bold; font-size: 24px; margin-bottom: 10px;">3</div> <div style="text-align: center; font-weight: bold; font-size: 24px; margin-bottom: 10px;">06</div> <div style="text-align: center; font-weight: bold; margin-bottom: 10px;">finish</div> <p style="text-align: center;">Insert 06 for Satin Brass finish.</p> <p style="text-align: center;"><i>See inside back cover of the catalog for all finish options.</i></p>	<div style="text-align: center; font-weight: bold; font-size: 24px; margin-bottom: 10px;">4</div> <div style="text-align: center; font-weight: bold; font-size: 24px; margin-bottom: 10px;">M4</div> <div style="text-align: center; font-weight: bold; margin-bottom: 10px;">keyway</div> <p style="text-align: center;">Insert keyway if known or contact Customer Service for help.</p>	<div style="text-align: center; font-weight: bold; font-size: 24px; margin-bottom: 10px;">5</div> <div style="text-align: center; font-weight: bold; font-size: 24px; margin-bottom: 10px;">P</div> <div style="text-align: center; font-weight: bold; margin-bottom: 10px;">pinning</div> <p>S = Sub-Assembled (Uncombined) N = Sub-assembled, – No side pins (M4 only) – No slider (M3 only) P = Pinned (Combinated) M = Master Keyed R = Master Keyed – blade and side pins (M4 only)</p>	<div style="text-align: center; font-weight: bold; font-size: 24px; margin-bottom: 10px;">6</div> <div style="text-align: center; font-weight: bold; font-size: 24px; margin-bottom: 10px;">624</div> <div style="text-align: center; font-weight: bold; margin-bottom: 10px;">side pin code</div> <div style="text-align: center; font-weight: bold; font-size: 18px; margin-bottom: 10px;">(M4 only)</div> <p style="text-align: center;">Insert side pin code if known or contact Customer Service for help.</p>
---	--	--	--	---

BUILD A 50 SERIES BRASS PADLOCK BASE PART

50 XX X X X X

<p>Prefix _____</p> <p>Function _____</p> <p>02 = Interchangeable Core (Key Retained) 03 = Interchangeable Core (Non-Key Retained) 06 = CLIQ Interchangeable Core (Key Retained) 07 = CLIQ Interchangeable Core (Non-Key Retained) 08 = Removable Cylinder (Key Retained) 09 = Removable Cylinder (Non-Key Retained) 74 = Case Only Sub Assy (Key Retained) 75 = Case Only Sub Assy (Non-Key Retained) 76 = CLIQ Case Only Sub-Assy (Key Retained) 77 = CLIQ Case Only Sub-Assy (Non-Key Retained)</p>	<p>Options</p> <p>0 = Chain 1 = Dust Cover 2 = Chain And Dust Cover 3 = Rubber Case Cover 4 = Rubber Case Cover and Dust Cover 5 = Rubber Case Cover, Dust Cover And Chain 6 = Rubber Case Cover And Chain</p> <p>Shackle Diameter</p> <p>1 = 3/8" Diamter</p> <p>Shackle Material</p> <p>0 = Steel (Case Hardened) 1 = Stainless Steel</p> <p>Shackle Clearance</p> <p>2 = 2-1/4"</p>
--	--

For legacy technology pricing, call Customer Service or visit Medeco.com.

How to Order a 52 Series Padlock:

Complete part numbers are required for all orders. To determine the correct part number, fill in the "Xs" in sequential order.

1

52620200 base part # example

Refer to pages 144-145 for descriptions and technical specifications to find the corresponding base part number.

2

H technology

T = M³
W = Biaxial
- = Original
S = M³ CLIQ

3

06 finish

Insert 06 for
Satin Brass finish.

See inside back cover
of the catalog for
all finish options.

4

M4 keyway

Insert keyway
if known or contact
Customer Service
for help.

5

P pinning

S = Sub-Assembled
(Uncombined)
N = Sub-assembled,
- No side pins (M4 only)
- No slider (M3 only)
P = Pinned (Combined)
M = Master Keyed
R = Master Keyed
- blade and side pins
(M4 only)

BUILD A 52 SERIES BRASS PADLOCK BASE PART

52 X X X X XX

Prefix

Body Type

6 = Brass Body 2-1/16" X 2-1/4"

Shackle

0 = 7/16" Ø X 1-3/8"
1 = 7/16" Ø X 1-7/8"
2 = 5/16" Ø X 1-1/8"
3 = 5/16" Ø X 2-3/8"

Shackle Material

0 = Hardened Steel
1 = Stainless Steel

Assembly Variations

00 = Standard
*01 = Rubber Boot
10 = Dust Cover
*11 = Dust Cover and Boot

*NOTE: For 7/16" Shackle Only

Type of Cylinder

0 = Key Retaining No Cylinder
1 = Key Retaining With Cylinder
2 = Key Retaining Removable Core
Less Cylinder

For legacy technology pricing, call Customer Service or visit Medeco.com.

50 Series Brass Body Padlocks

Description	Part Number	M4	M3
I/C Core Brass Padlock, 2-1/4" Shackle Clearance, Hardened Steel, Key Retaining	5002201 (P)	\$426.50	\$444.95
	5002201 (S)	\$410.00	\$428.45
I/C Core Brass Padlock, 2-1/4" Shackle Clearance, Stainless Steel, Key Retaining	5002211 (P)	\$426.50	\$444.95
	5002211 (S)	\$410.00	\$428.45
I/C Core Brass Padlock, 2-1/4" Shackle Clearance, Hardened Steel, Non-key Retaining	5003201 (P)	\$426.50	\$444.95
	5003201 (S)	\$410.00	\$428.45
I/C Core Brass Padlock, 2-1/4" Shackle Clearance, Stainless Steel, Non-key Retaining	5003211 (P)	\$426.50	\$444.95
	5003211 (S)	\$410.00	\$428.45
Removable Cylinder Brass Padlock, 2-1/4" Shackle Clearance, Hardened Steel, Key Retaining	5008201 (P)	\$402.50	\$419.87
	5008201 (S)	\$386.00	\$403.37
Removable Cylinder Brass Padlock, 2-1/4" Shackle Clearance, Stainless Steel, Key Retaining	5008211 (P)	\$402.50	\$419.87
	5008211 (S)	\$386.00	\$403.37
Removable Cylinder Brass Padlock, 2-1/4" Shackle Clearance, Hardened Steel, Non-key Retaining	5009201 (P)	\$402.50	\$419.87
	5009201 (S)	\$386.00	\$403.37
Removable Cylinder Brass Padlock, 2-1/4" Shackle Clearance, Stainless Steel, Non-key Retaining	5009211 (P)	\$402.50	\$419.87
	5009211 (S)	\$386.00	\$403.37
Brass Padlock, 2-1/4" Shackle Clearance, Hardened Steel, Key Retaining, Less Cylinder	50-74201	\$204.00	
Brass Padlock, 2-1/4" Shackle Clearance, Stainless Steel, Key Retaining, Less Cylinder	50-74211	\$204.00	
Brass Padlock, 2-1/4" Shackle Clearance, Hardened Steel, Non-key Retaining, Less Cylinder	50-75201	\$204.00	
Brass Padlock, 2-1/4" Shackle Clearance, Stainless Steel, Non-key Retaining, Less Cylinder	50-75211	\$204.00	

(P) = Pinned (combined)

(S) = Sub-assembled (uncombined)

Surcharges for Master Keying, Custom Coining and Custom Stamping apply, see page 196.
Refer to the XT and CLIQ Intelligent Key sections for format availability and pricing.

52 Series Padlock, 5/16" Shackle

Description	Part Number	M3
1-1/8" Clearance, Boron Alloy Shackle	526201 (P)	\$219.23
	526201 (S)	\$202.73
2-3/8" Clearance, Boron Alloy Shackle	526301 (P)	\$219.23
	526301 (S)	\$202.73
1-1/8" Clearance, Boron Alloy Shackle, Less Cylinder	526200	\$126.66
2-3/8" Clearance, Boron Alloy Shackle, Less Cylinder	526300	\$126.66
1-1/8" Clearance, Stainless Steel Shackle	526211 (P)	\$219.23
	526211 (S)	\$202.73
2-3/8" Clearance, Stainless Steel Shackle	526311 (P)	\$219.23
	526311 (S)	\$202.73
1-1/8" Clearance, Stainless Steel Shackle, Less Cylinder	526210	\$126.66
2-3/8" Clearance, Stainless Steel Shackle, Less Cylinder	526310	\$126.66

*Padlock body is solid brass with 26 plated finish.

52 Series Padlock, 5/16" Shackle, Removable Core

Description	Part Number	M3
1-1/8" Clearance, Boron Alloy Shackle, Removable Core, Less Cylinder	52-6202	\$154.85
2-3/8" Clearance, Boron Alloy Shackle, Removable Core, Less Cylinder	52-6302	\$154.85
1-1/8" Clearance, Stainless Steel Shackle, Removable Core, Less Cylinder	52-6212	\$154.85
2-3/8" Clearance, Stainless Steel Shackle, Removable Core, Less Cylinder	52-6312	\$154.85

*Padlock body is solid brass with 26 plated finish.

Note: 52-6 Series padlocks use a 5 pin/4 level 60 Series cylinder and can be keyed into a system utilizing cam and switch locks.

(P) = Pinned (combined)

(S) = Sub-assembled (uncombined)

Surcharges for Master Keying, Custom Coining and Custom Stamping apply, see page 196.
Refer to the XT and CLIQ Intelligent Key sections for format availability and pricing.

52 Series Padlock, 7/16" Shackle

Description	Part Number	M3
1-3/8" Clearance, Boron Alloy Shackle	526001 (P)	\$219.23
	526001 (S)	\$202.73
1-7/8" Clearance, Boron Alloy Shackle	526101 (P)	\$219.23
	526101 (S)	\$202.73
1-3/8" Clearance, Boron Alloy Shackle, Less Cylinder	526000	\$126.66
1-7/8" Clearance, Boron Alloy Shackle, Less Cylinder	526100	\$126.66
1-3/8" Clearance, Stainless Steel Shackle	526011 (P)	\$219.23
	526011 (S)	\$202.73
1-7/8" Clearance, Stainless Steel Shackle	526111 (P)	\$219.23
	526111 (S)	\$202.73
1-3/8" Clearance, Stainless Steel Shackle, Less Cylinder	526010	\$126.66
1-7/8" Clearance, Stainless Steel Shackle, Less Cylinder	526110	\$126.66

* Padlock body is solid brass with 26 plated finish.

52 Series Padlock, 7/16" Shackle, Removable Core

Description	Part Number	M3
1-3/8" Clearance, Boron Alloy Shackle, Removable Core, Less Cylinder	526002	\$154.85
1-7/8" Clearance, Boron Alloy Shackle, Removable Core, Less Cylinder	526102	\$154.85
1-3/8" Clearance, Stainless Steel Shackle, Removable Core, Less Cylinder	526012	\$154.85
1-7/8" Clearance, Stainless Steel Shackle, Removable Core, Less Cylinder	526112	\$154.85

* Padlock body is solid brass with 26 plated finish.

52 series Padlocks Cover Options: 00 = Standard, 01 = Case Cover, 10 = Dust Cover

Note: 52-6 Series padlocks use 5 pin/4 level 60 Series cylinders and can be keyed into a system utilizing cam and switch locks.

Hockey Puck Padlocks



Medeco Hockey Puck style padlocks are the go-to choice wherever shackle attacks are a concern.

The reimagined padlock design now accepts industry-standard Large Format Interchangeable Cores (LFIC) and key-in-knob/lever cylinders. Pre-machined holes in the back allow for flexible mounting options. When combined with a mounted hasp the padlock remains attached, preventing the loss of the padlock.

The 304 stainless steel body provides the highest combination of drilling resistance, cutting resistance, and weatherability. The shackle-less design with a hidden bolt provides the highest level of protection against bolt cutter attacks.

Hockey puck padlocks are completely serviceable and can be re-keyed in case of lost or stolen keys. They can be ordered in a variety of different cylinder technologies. This includes in a high security format (Medeco 4) and Medeco XT for access control, audit trails, and much more. Hockey Puck Padlocks with X4 and M4 cylinders also offer patent protected key control.



Patented Key Control

Protects against unauthorized duplication of your keys.



Protection From Physical Attack

M4 cylinders use cylinder side pins, a lift pin and a movable key element to engage a sidebar that prevents the key from turning until the elements are rotated and aligned in the correct position, protecting against bumping, picking and other attacks.



Can Be Master Keyed

Medeco Hockey Puck Padlocks can be master keyed into existing Medeco 10 Series products.



Available in Intelligent Key

Medeco's Hockey Puck Padlocks are also available with the Medeco XT Intelligent Key system for Loss & Liability control.



Special Angle Cut Keys

Requires a special key cutting machine and access to Medeco specific blanks, available in a variety of restrictions to support every need.



Picking and Bumping Protection

M4 cylinders use a sidebar that prevent the key from rotating until it is elevated, rotated and aligned in the correct position. This feature protects against bumping and picking attacks.

Technical Features:

- Body width: 2-7/8"
- Shackle: 3/8" diameter
- 304 stainless steel body
- LFIC and key-in-knob/lever cylinders
- Requires a key to relock
- Flat-back design or step-back design
- Shackle-less design with a hidden bolt for a high level of protection against bolt cutter attacks
- Pre-machined holes in the back allow for flexible mounting options

Applications:

- Gaming machines/gaming padlocks
- Vending machines
- Service vehicles/vans
- Storage cabinets/containers and shipping containers
- Gates

Available Key Technologies:

- M4/M4 BiLevel - XT
- M³/M³ BiLevel - CLIQ
- X4

52-9 Series Hockey Puck Padlock

Description	Part Number	M4	M4 BiLevel	M3	M3 BiLevel	X4
Hockey Puck Padlock with KIK/KIL 6 Pin Cylinder (flat back)	5292000 (P) 5292000 (S)	\$238.50	\$248.49	\$219.96	\$259.59	\$240.55
Hockey Puck Padlock with KIK/KIL 6 Pin Cylinder (step back)	5292001 (P) 5292001 (S)	\$238.50	\$248.49	\$219.96	\$259.59	\$240.55
Hockey Puck Padlock with LFIC 6 Pin Cylinder (flat back)	5292100 (P) 5292100 (S)	\$238.50	\$248.49	\$219.96	\$259.59	\$240.55
Hockey Puck Padlock with LFIC 6 Pin Cylinder (step back)	5292101 (P) 5292101 (S)	\$238.50	\$248.49	\$219.96	\$259.59	\$240.55

G8R Padlocks

Medeco® offers a variety of High Security Padlocks that are designed to accept both mechanical and Intelligent Key cylinders. With its tough, weather resistant construction, this is the padlock of choice for extreme environments such as trailers, cargo containers, and gates. The Medeco® G8R body is constructed of solid stainless steel. You can choose from either a stainless steel shackle for maximum corrosion resistance, or hardened steel to withstand severe physical attack. Each padlock includes a weather seal cap attached by a cable. The Medeco® G8R will accept either an Intelligent Key or mechanical t-handle cylinder. The mechanical cylinders provide the benefit of patented key control and pick resistance. Intelligent Keys sophisticated audit and control features transforming the G8R into a portable access control system for extreme environments.

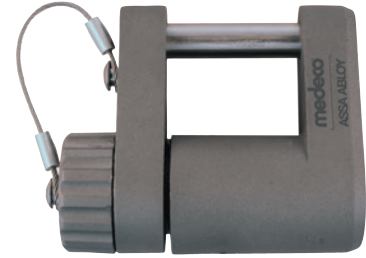

Patented Key Control

Protects against unauthorized duplication of your keys.



Protection From Physical Attack

Medeco³ padlock cylinders are UL 437 listed and stand up to drilling, picking and other forms of physical attack. Available in either a hardened steel shackle to withstand severe physical attack or a stainless steel shackle for maximum corrosion resistance.



Weather Resistant Construction

Uses a weather seal cap, attached by a cable, to provide protection from water and road grime.



Available in Intelligent Key

Medeco G8R Padlocks are also available with Medeco Intelligent Key systems for Loss & Liability control.



Special Angle Cut Keys

Requires a special key cutting machine and access to Medeco specific blanks, available in a variety of restrictions to support every need.



Picking and Bumping Protection

Medeco³ cylinders use a sidebar that prevent the key from rotating until it is elevated, rotated and aligned in the correct position. This feature protects against bumping and picking attacks.

Technical Information:

- 300 series, cast stainless steel body.
- Padlock is sold less cylinder. Compatible with Medeco® mechanical and NEXGEN electronic t-handle cylinders.
- Padlocks are shipped with a weather seal cap attached by a steel cable. A finish plate is included for applications that do not require the weather seal cap.
- Sealed construction protects cylinders from water and road grime.
- Stainless steel body resists attack and corrosion.
- Shackles can be specified in stainless or hardened steel to fit your application.

Applications:

- The G8R Series was designed for locking installations requiring weather resistance and strong physical security. Applications include: cargo containers, trailer doors, gates, vending machines.

Warranty:

Warranted for two (2) years against manufacturer's defects. See the Medeco® limited warranty for full details

Available Key Technologies:

Mechanical:

- M³

Intelligent Key:

- Medeco XT
- Classic CLIQ
- Medeco Nexgen

G8R Series Padlock

Description	Part Number	Price
G8R Weather-tight Padlock, 5/16" Stainless Steel Shackle, less pop-out cylinder	52110040	\$198.00
G8R Weather-tight Padlock, 5/16" Hardened Steel Shackle, less pop-out cylinder	52111040	\$198.00
G8R Weather-tight Padlock, 7/16" Stainless Steel Shackle, less pop-out cylinder	52120040	\$198.00
G8R Weather-tight Padlock, 7/16" Hardened Steel Shackle, less pop-out cylinder	52121040	\$198.00
G8R cap and seal kit	94-0213	\$33.50

G8R padlocks are sold less cylinder and use a cam lock style key with pop-out plug.

Keys are charged separately for this style cylinder.

Experience a safer
and more open world

medeco
ASSA ABLOY

Padlock Cylinders

Description	Part Number	M4	M4 BiLevel	M3	M3 BiLevel	X4
5 Pin Cylinder (6 pin Medeco X4) for Hockey Puck Style Padlock sold between 9/2004 and 9/2023 (KIK style cylinder)	2001600 (P)	\$128.50	\$70.04	\$133.54	\$72.56	\$64.00
	2001600 (S)	\$112.00	\$61.04	\$117.04	\$63.56	\$47.50
6 Pin Cylinder for Hockey Puck Style Padlock sold after 9/2023	2020000 (P)	\$176.50	\$96.20	\$183.70	\$99.80	\$112.00
	2020000 (S)	\$160.00	\$87.20	\$167.20	\$90.80	\$95.50
6 Pin Cylinder for LFIC Medeco Padlocks, 50 (Brass Body Series) & 54 Series	320201 (P)	\$192.50	\$104.92	\$200.42	\$108.88	\$134.35
	320201 (S)	\$176.00	\$95.92	\$183.92	\$99.88	\$117.85
Removable Cylinder to fit 50 Series Brass Padlocks (Note - only available in 06 finish)	320202 (P)	\$169.50		\$176.38		
	320202 (S)	\$153.00		\$159.88		
6 Pin Cylinder for KIK Medeco Padlock, for 54 Series Padlocks	510600 (P)	\$142.50	\$77.93	\$148.17	\$80.77	\$123.96
	510600 (S)	\$126.00	\$68.93	\$131.67	\$71.77	\$107.46
5 Pin Spring Bolt Cylinder (non-key retaining), for G8R Padlock	960357 (P)	\$140.00		\$145.00		
	960357 (S)	\$111.00		\$116.00		
5 Pin Deadbolt Cylinder (key retaining), for G8R Padlock	960358 (P)	\$140.00		\$145.00		
	960358 (S)	\$111.00		\$116.00		
Spacer for use with 5 Pin Cylinders, for G8R Padlock	CP-160691	\$2.46				
	66418 (P)			\$128.69		
5 Pin cylinder (cam lock style) for 52-6 padlocks	66418 (S)			\$99.69		
	66391 (P)			\$109.05		
5 Pin Removable plug for 52-6 padlocks	66391 (S)			\$80.05		

Electronic padlock cylinders are available for many of the padlocks. Refer to the XT and CLIQ sections for specific part numbers and pricing.

Components

Description	Part Number	Price
Component Package for 54 Series Padlocks, NonKey Retaining. Includes CP-130510 Cylinder Extension/Actuator, Spring & Washer, CP-022030 Cylinder Retainer, CP-011511-000 Retainer Screw, CP-250140 Steel Ball Bearing	94-0199	\$17.20
Cylinder Retainer Sleeve (Fits over Cylinder Bible Chamber & holds cylinder in padlock body)	CP-022030	\$9.05
Retainer Screw, #6-32 UNC-2A x .312" length	CP-011511-000	\$0.83
Cylinder Extension/Actuator, Non Key Retaining, Spring & Washer for 54 Series Padlocks	CP-130510	\$7.62
Stainless Steel Ball Bearing for 54 Series Padlocks, .360" Diameter	CP-250140	\$0.83
Cylinder Extension/Actuator, Key Retaining, for 54 Series Padlocks	CP-200720	\$7.62
Chain Assembly for 50 Series Brass Padlocks	CP-280271	\$40.60
Case Cover for 50 Series Brass Padlocks	CP-170250	\$24.40
Shackle Spring for 50 Series Brass Padlocks	CP-030430	\$0.53
Actuator Adaptor for 50 Series Brass Padlocks	CP-130101	\$10.50
Locking Balls for 50 Series Brass Padlocks	CP-250040	\$2.06
3/16" Cylinder Retaining Ball for 50 Series Brass Padlocks	CP-250030	\$0.50
1/16" Hex Allen Wrench - Long Arm to use with 50 Series Brass Padlocks	94-0020	\$6.47
Package for Sub-assembled 50 Series Brass Padlock, Includes: Set screws, retaining ball, Brass Pin Chamber Cover Chain, 7/16" Collar and Rivet, Eye Strap	94-0052	\$19.30

(P) = Pinned (combined)

(S) = Sub-assembled (uncombined)

Surcharges for Master Keying, Custom Coining and Custom Stamping apply, see page 196. Refer to the XT and CLIQ Intelligent Key sections for format availability and pricing.

Shackles for Indoor/Outdoor Padlocks

Description	Boron Alloy Steel		Stainless Steel	
	Part Number	Price	Part Number	Price
Standard Shackle for 54-51 Indoor/Outdoor Padlock, 1-1/8" Shackle Clearance x 5/16" Diameter	CP-144120	\$13.20	CP-144180	\$19.80
Extra Length Shackle for 54-51 Indoor/Outdoor Padlock, 2-3/8" Shackle Clearance x 5/16" Diameter	CP-144130	\$16.00	CP-144190	\$22.20
Standard Shackle for 54-71 Indoor/Outdoor Padlock, 1-3/8" Shackle Clearance x 7/16" Diameter	CP-144150	\$16.00	CP-144210	\$22.20
Extra Length Shackle for 54-71 Indoor/Outdoor Padlock, 1-7/8" Shackle Clearance x 7/16" Diameter	CP-144160	\$17.70	CP-144220	\$24.40

Shackles for Shrouded Padlocks

Description	Boron Alloy Steel		Stainless Steel	
	Part Number	Price	Part Number	Price
Standard Shackle for 54-52 Shrouded Padlock, 3/4" Shackle Clearance x 5/16" Diameter	CP-144110	\$13.20	CP-144170	\$19.80
Standard Shackle for 54-72 Shrouded Padlock, 3/4" Shackle Clearance x 7/16" Diameter	CP-144140	\$16.00	CP-144200	\$22.20

Shackles for 50 Series Brass Padlocks

Description	Part Number	Price
2-1/4" Stainless Steel Shackle for 50 Series Brass Padlocks	CP-142543	\$70.20
2-1/4" Hardened Steel Shackle for 50 Series Brass Padlocks	CP-142043	\$65.70

Protector II Series Padlock Cylinder

Description	Part Number	M4		M3		X4
		M4	M4 BiLevel	M3	M3 BiLevel	
KIK style cylinder for Protector II	500020 (P)	\$120.50		\$125.18		
	500020 (S)	\$104.00		\$108.68		

Protector II Series Padlock Parts

Description	Part Number	Price
Disk For Standard Key In Knob Cylinder	CP-171011	\$19.30
Disk For CLIQ Cylinder	CP-171021	\$19.30
Disk For Medeco XT Cylinder	CP-171031	\$19.30

(P) = Pinned (combined)
 (S) = Sub-assembled (uncombined)
 Surcharges for Master Keying, Custom Coining and Custom Stamping apply, see page 196.
 Refer to the XT and CLIQ Intelligent Key sections for format availability and pricing.

Cam Locks

Medeco® High Security Cam Locks are recognized throughout the world as the standard for protection in a 3/4 inch diameter lock. Medeco Cam Locks utilize hardened, stainless steel inserts throughout the cylinder to provide the ultimate defense against drilling, pulling, and other forms of vandal attacks. Patented key control programs prevent the unauthorized duplication of keys and maintain system integrity. Keyed alike, keyed different, or master keyed, Medeco offers a complete line of cam locks in a wide variety of sizes and functions to meet your specific needs.



Patented Key Control

Protects against unauthorized duplication of your keys.



Available in Intelligent Key System

Medeco cam locks are also available with Medeco Intelligent Key Systems for loss & liability control.



Can Be Master Keyed

Medeco Cam Locks can be keyed alike, keyed different or master keyed.



Protection From Physical Attack

Medeco³ cam locks are UL 437 Listed and stand up to drilling, picking and other forms of physical attack.

Benefits:

- All Medeco cylinders are constructed of durable machined brass components.
- Hardened stainless steel inserts inside the cylinder provide the ultimate defense against drilling and other forms of physical attack.
- Unique elevating and rotating tumbler pin system is virtually pick proof.
- Patented Medeco³ keys may only be duplicated by Medeco or an authorized Medeco service outlet, and only at your request.
- Locks can be keyed alike, keyed different, or master keyed depending on your specific needs.
- Available in various lengths and rotations.

Technical Information:

- Four or five pin models available depending on size
- Available in three standard sizes, 11/16 inch, 7/8 inch and 1-1/8 inch. Other sizes available upon request.
- Two flat models available, key retaining only
- Clockwise or counterclockwise rotation, 90 or 180 degrees
- Keyed alike, keyed different, or master keyed

Warranty:

Warranted for two (2) years against manufacturer's defects. See the Medeco limited warranty for full details

Finishes:

- 26 satin chrome finish standard
- Other finishes available, depending on volume

Certification:

- UL 437 Listed

Applications:

Medeco Cam Locks can be used in any standard 3/4 inch diameter application and a multitude of markets including:

- Safes
- Communication
- Alarm
- Access control
- Banking
- Utility
- Data Encryption
- Cabinet
- Transit
- Lockers

Available Key Technologies:

Mechanical:

- M³
- X4

Intelligent Key:

- Classic CLIQ
- Medeco XT

Medeco³ All-In-One Cam Lock Kits

Description	Part Number	M3
7/8" Length 5 Pin Cam Lock Kit	600350T KIT (P)	\$147.40
	600350T KIT (S)	\$118.39
1-1/8" Length 5 Pin Cam Lock Kit	600650T KIT (P)	\$147.40
	600650T KIT (S)	\$118.39
5/8" Length 5 Pin Cam Lock Kit	601150T KIT (P)	\$147.40
	601150T KIT (S)	\$118.39
1-1/2" 5 Pin Cam Lock Kit	601450T KIT (P)	\$152.62
	601450T KIT (S)	\$123.62

X4 Cam Lock Kit

Description	Part Number	X4
1-1/8" length Medeco X4 7 pin cam lock kit with two cams, hex nut, lock washer, mounting washer and 1/4" spacer collar.	210503 (P)	\$111.40
	210503 (S)	\$94.90

There is a 6 piece minimum order quantity for high security Cam Lock Kits.

All-in-One Cam Lock Kits include: CP-040500 pronged washer, CT-A05 flat cam, CT-D05 flat cam, CT-J01 offset cam, CT-H07 offset cam, CP-040451 90 degree stop washer, CP-040461 180 degree stop washer CP-050060 3/4" - 27 mounting nut and 2 keys.

Master keying is not available in a Cam Lock kit, but may be custom ordered with specific Cam Locks listed on the following pages.

(P) = Pinned (combined)

(S) = Sub-assembled (uncombined)

Surcharges for Master Keying, Custom Coining and Custom Stamping apply, see page 196.
Refer to the XT and CLIQ Intelligent Key sections for format availability and pricing.

High Security Cam Locks

Description	Part Number	M3
5 pin, 11/16" Cam Lock	600250T (P)	\$136.63
	600250T (S)	\$107.64
5 pin, 7/8" Cam Lock	600350T (P)	\$136.63
	600350T (S)	\$107.64
5 pin, 1" Cam Lock	600450T (P)	\$136.63
	600450T (S)	\$107.64
4 pin, 7/8" Cam Lock	600550T (P)	\$133.19
	600550T (S)	\$104.19
5 pin, 1-1/8" Cam Lock	600650T (P)	\$136.63
	600650T (S)	\$107.64
4 pin, 11/16" Cam Lock	600750T (P)	\$133.19
	600750T (S)	\$104.19
4 pin, 5/8" Cam Lock	600850T (P)	\$133.19
	600850T (S)	\$104.19
5 pin, 3/4" Cam Lock	600950T (P)	\$136.63
	600950T (S)	\$107.64
5 pin, 5/8" Cam Lock	601150T (P)	\$136.63
	601150T (S)	\$107.64
3 pin, 7/16" Cam Lock	601250T (P)	\$121.59
	601250T (S)	\$92.59
3 pin, 5/8" Cam Lock	601251T (P)	\$121.59
	601251T (S)	\$92.59
5 pin, 1-1/2" Cam Lock	601450T (P)	\$141.86
	601450T (S)	\$112.86
5 pin, 2" Cam Lock	601452T (P)	\$146.04
	601452T (S)	\$117.04

You must specify the operation code to complete the part number. Pinned pricing includes two keys. Standard sizes described, contact Medeco customer service or medeco.com for variations not listed.

There is a 6 piece minimum order quantity for high security Cam Locks Kits.

Medeco Cam Lock Part Number Configurations

Part Number	Operation Code	Technology	Finish	Keyway	"Cam Lock Operation Code" – Describes the function of the lock: direction of key turn, rotation, key retaining or two key-pull.
XXXXXXXX	XXX	X	26	XX	

Cam Lock Operation Codes – Fixed Core Cam Locks

Describes the function of the lock

Operation Code	Rotation Distance	Direction to Unlock	Key Retaining or 2 Key Pull
219	90°	Clockwise	Key Retaining
229	90°	Clockwise	2 Key Pull
239	90°	Counterclockwise	Key Retaining
249	90°	Counterclockwise	2 Key Pull
259	180°	Clockwise	Key Retaining
269	180°	Clockwise	2 Key Pull
279	180°	Counterclockwise	Key Retaining
289	180°	Counterclockwise	2 Key Pull

Note: Key Retaining – Key is removable in the locked position only.

2 Key Pull – Key is removable in both the locked and unlocked positions.

(P) = Pinned (combined)

(S) = Sub-assembled (uncombined)

Surcharges for Master Keying, Custom Coining and Custom Stamping apply, see page 196.
Refer to the XT and CLIQ Intelligent Key sections for format availability and pricing.

Removable Core Cam Locks

Medeco® Cam Locks are available with a removable core feature allowing cores to be changed out in seconds, to provide an entirely new keying combination. For applications that may require instantaneous re-keying due to lost or stolen keys, or where periodic re-keying is done as a matter of good business practice, Medeco removable core cam locks save valuable time and money. Removable core cam locks offer the same high security features of a Medeco cam lock with the convenience of a removable core.



Patented Key Control

Protects against unauthorized duplication of your keys.



Quickly Change Cores

Medeco removable provide quick and easy cylinder changes in the event keys are lost or stolen.



Protection From Physical Attack

Medeco³ Cam Locks are UL 437 Listed and stand up to drilling, picking and other forms of physical attack.

Benefits:

- Removable cores can be changed out in seconds to provide a new, secure keying combination.
- All Medeco cylinders are constructed of durable machined brass components.
- Hardened stainless steel inserts inside the cylinder provide the ultimate defense against drilling and other forms of physical attack.
- Unique elevating and rotating tumbler pin system is virtually pick proof.
- Patented Medeco³ keys may only be duplicated by Medeco or an authorized Medeco service outlet, and only at your request.
- Locks can be keyed alike, keyed different, or master keyed depending on your specific needs.
- Available in various lengths and rotations.

Technical Information:

- Four or five pin models available depending on size
- Available in three standard sizes, 11/16 inch, 7/8 inch and 1-1/8 inch
- Two flat models available, key retaining only
- Clockwise or counterclockwise rotation, 90 or 180 degrees
- Keyed alike, keyed different, or master keyed

Warranty:

Warranted for two (2) years against manufacturer's defects. See the Medeco® limited warranty for full details

Finishes:

- 26 satin chrome finish standard
- Other finishes available, depending on volume

Applications:

- Medeco® Removable Core Cam Locks can be used in any standard 3/4 inch diameter application and a multitude of markets including:
 - Safes
 - Utility
 - Communications
 - Data Encryption
 - Alarms
 - Cabinets
 - Access control
 - Transit
 - Banking
 - Lockers

Available Key Technologies:

Mechanical:

– M³

High Security Removable Core Cam Locks

Description	Part Number	M3
4 pin, 1 1/16" Removable core Cam Lock	607155XT (P)	\$155.44
	607155XT (S)	\$126.44
4 pin, 7/8" Removable core Cam Lock	607255XT (P)	\$155.44
	607255XT (S)	\$126.44
4 pin, 1-1/8" Removable core Cam Lock	607355XT (P)	\$155.44
	607355XT (S)	\$126.44
5 pin, 1-1/8" Removable core Cam Lock	607455XT (P)	\$157.53
	607455XT (S)	\$128.53
5 pin, 7/8" Removable core Cam Lock	607555XT (P)	\$157.53
	607555XT (S)	\$128.53
Plug for Removable Core Cam Locks. Cam Locks are provided with plug, but additional plugs may be ordered separately. Keys not included in price.	66391 (P)	\$109.05
	66391 (S)	\$80.05

Pinned price includes 2 keys.

X = Rotation for Removable Core Cam Lock

Description	Part Number
90 degree Clockwise	0
90 degree Counterclockwise	1
180 degree Clockwise	2
180 degree Counterclockwise	3



A Series Flat Cams

Description	Part Number	Price
5/8" Flat Cam	CT-A00	\$3.55
3/4" Flat Cam	CT-A01	\$3.55
7/8" Flat Cam	CT-A02	\$3.55
1" Flat Cam	CT-A03	\$3.55
1-1/8" Flat Cam	CT-A04	\$3.55
1-1/4" Flat Cam	CT-A05	\$3.55
1-3/8" Flat Cam	CT-A06	\$3.55
1-1/2" Flat Cam	CT-A07	\$3.55
1-5/8" Flat Cam	CT-A08	\$3.55
1-3/4" Flat Cam	CT-A09	\$3.55
2" Flat Cam	CT-A11	\$3.55
2-1/8" Flat Cam	CT-A12	\$3.55
2-1/4" Flat Cam	CT-A13	\$3.55
2-3/8" Flat Cam	CT-A14	\$3.55
2-1/2" Flat Cam	CT-A15	\$3.55
2-5/8" Flat Cam	CT-A16	\$3.55
3" Flat Cam	CT-A19	\$3.55

(P) = Pinned (combined)

(S) = Sub-assembled (uncombined)

Surcharges for Master Keying, Custom Coining and Custom Stamping apply, see page 196.
Refer to the XT and CLIQ Intelligent Key sections for format availability and pricing.



C Series Flat Cams, 45° Tenon

Description	Part Number	Price
7/8" Flat Cam	CT-C02	\$3.55
1-1/8" Flat Cam	CT-C04	\$3.55
1-1/4" Flat Cam	CT-C05	\$3.55
1-5/8" Flat Cam	CT-C08	\$3.55
1-3/4" Flat Cam	CT-C09	\$3.55
2" Flat Cam	CT-C11	\$3.55



D Series Flat Cams, Horizontal Tenon

Description	Part Number	Price
5/8" Flat Cam	CT-D00	\$3.55
3/4" Flat Cam	CT-D01	\$3.55
7/8" Flat Cam	CT-D02	\$3.55
1" Flat Cam	CT-D03	\$3.55
1-1/8" Flat Cam	CT-D04	\$3.55
1-1/4" Flat Cam	CT-D05	\$3.55
1-3/8" Flat Cam	CT-D06	\$3.55
1-1/2" Flat Cam	CT-D07	\$3.55
1-5/8" Flat Cam	CT-D08	\$3.55
1-3/4" Flat Cam	CT-D09	\$3.55
2" Flat Cam	CT-D11	\$3.55
2-1/8" Flat Cam	CT-D12	\$3.55
2-1/2" Flat Cam	CT-D15	\$3.55
3" Flat Cam	CT-D19	\$3.55



H Series Offset Cam, Vertical Tenon

Description	Part Number	Price
1-1/4" Cam with 1/8" offset	CT-H00	\$3.69
1-1/8" Cam with 7/32" offset	CT-H07	\$3.69
1-1/8" Cam with 1/8" offset	CT-H09	\$3.69
1-1/2" Cam with 7/32" offset	CT-H14	\$3.69
1-1/4" Cam with 7/32" offset	CT-H15	\$3.69
1-1/8" Cam with 5/16" offset	CT-H16	\$3.69
1-1/4" Cam with 5/16" offset	CT-H17	\$3.69
1-3/4" Cam with 5/16" offset	CT-H19	\$3.69
2" Cam with 5/16" offset	CT-H20	\$3.69
7/8" Cam with 5/32" offset	CT-H27	\$3.69
1-3/4" Cam with 7/32" offset	CT-H30	\$3.69
1-1/2" Cam with 5/16" offset	CT-H32	\$3.69

(P) = Pinned (combined)

(S) = Sub-assembled (uncombined)

Surcharges for Master Keying, Custom Coining and Custom Stamping apply, see page 196.
Refer to the XT and CLIQ Intelligent Key sections for format availability and pricing.



J Series Offset Cam, Horizontal

Description	Part Number	Price
1-1/8" Cam with 7/32" offset	CT-J01	\$3.69
1" Cam with 1/8" offset	CT-J05	\$3.69
1-1/4" Cam with 1/8" offset	CT-J07	\$3.69
1-5/8" Cam with 1/8" offset	CT-J08	\$3.69
2-1/8" Cam with 1/8" offset	CT-J11	\$3.69
1-1/4" Cam with 7/32" offset	CT-J12	\$3.69
1-1/8" Cam with 5/16" offset	CT-J13	\$3.69
1-1/4" Cam with 5/16" offset	CT-J14	\$3.69
1-5/8" Cam with 5/16" offset	CT-J15	\$3.69
2-1/8" Cam with 5/16" offset	CT-J18	\$3.69
1-1/8" Cam with 5/32" offset	CT-J22	\$3.69
1-1/2" Cam with 5/16" offset	CT-J27	\$3.69
2-1/8" Cam with 7/32" offset	CT-J28	\$3.69
7/8" Cam with 5/32" offset	CT-J29	\$3.69
3/4" Hex nut for Cam Locks	CP-050060	\$2.06

3/4" Removable Plug Lock

Description	Part Number	M3
1 keypull, 3/4" Removable plug lock	640250T (P)	\$141.86
	640250T (S)	\$112.86
2 keypull, 3/4" Removable plug lock	640251T (P)	\$141.86
	640251T (S)	\$112.86

1 1/8" Removable Plug Lock

Description	Part Number	M3
1 keypull, vertical flats, flush mount	640550T (P)	\$160.67
	640550T (S)	\$131.67
1 keypull, horizontal flats, flush mount	640550AT (P)	\$160.67
	640550AT (S)	\$131.67
2 keypull, vertical flats, surface mount with tapered bezel	640550FT (P)	\$160.67
	640550FT (S)	\$131.67

Pinned price includes 2 keys.

Security Collars

Description	Part Number	Price
Cam Lock security collar	CP-070501	\$11.90
Cam Lock security collar	CP-070131	\$11.90
Cam Lock security collar	CP-070161	\$11.90
Cam Lock security collar	CP-070171	\$11.90
Cam Lock security collar	CP-070441	\$11.90
Cam Lock security collar	CP-070201	\$11.90
Cam Lock security collar	CP-070111	\$11.90
Cam Lock security collar	CP-070141	\$11.90
Cam Lock security collar	CP-070181	\$11.90
Cam Lock security collar	CP-070481	\$11.90

Security Collars

Part Number	(H)	(I)	(J)	(K)	(L)
CP-070501	1.000"	.142"	.170"	.312"	1.290"
CP-070131	.885"	.142"	.170"	.312"	1.210"
CP-070161	.885"	.188"	.250"	.438"	1.356"
CP-070171	.885"	.200"	.238"	.438"	1.290"
CP-070441	.885"	.260"	.070"	.330"	1.210"
CP-070201	.885"	.262"	.050"	.312"	1.210"
CP-070111	.885"	.278"	.160"	.438"	1.290"
CP-070141	.885"	.325"	.050"	.375"	1.275"
CP-070181	1.000"	.450"	.050"	.500"	1.250"
CP-070481	1.000"	.638"	.050"	.688"	1.313"

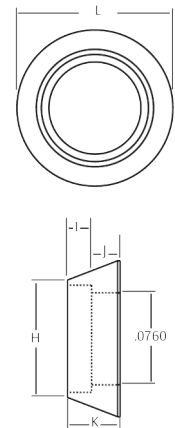

Spacers

Description	Part Number	Price
Cam lock spacer, obtain specific part number from following dimension chart.	CP-160XXX	\$10.10

Spacers

Part Number	(M)	(N)
CP-160051	.125"	.875"
CP-160101	.140"	.875"
CP-160071	.188"	.875"
CP-160111	.200"	.875"
CP-160081	.250"	.875"
CP-160091	.275"	.875"
CP-160301	.375"	.875"
CP-160121	.400"	.875"
CP-160061	.530"	.875"
CP-160271	.437"	.875"
CP-160541	.031"	.875"
CP-160551	.062"	.875"
CP-160571	.312"	.875"
CP-160591	.062"	.995"
CP-160601	.125"	.995"
CP-160611	.250"	.995"

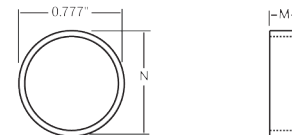

(P) = Pinned (combined)
 (S) = Sub-assembled (uncombined)
 Surcharges for Master Keying, Custom Coining and Custom Stamping apply, see page 196.
 Refer to the XT and CLIQ Intelligent Key sections for format availability and pricing.

Pop-Out, T-Handle Cylinder

Description	Part Number	M3
5 pin, zinc deadbolt	640155CT (P)	\$122.11
	640155CT (S)	\$93.11
5 pin, zinc springbolt	640155T (P)	\$122.11
	640155T (S)	\$93.11
4 pin, zinc springbolt	640750ET (P)	\$124.51
	640750ET (S)	\$95.51
4 pin, zinc deadbolt	640750GT (P)	\$124.51
	640750GT (S)	\$95.51
4 pin, steel springbolt	640950T (P)	\$134.54
	640950T (S)	\$105.55
4 pin, steel deadbolt	640952T (P)	\$134.54
	640952T (S)	\$105.55
4 pin, steel springbolt, steel shell	641050T (P)	\$173.21
	641050T (S)	\$144.21
4 pin, steel deadbolt, steel shell	641051T (P)	\$173.21
	641051T (S)	\$144.21

Pinned price includes two keys.

Note: Refer to the XT section for format availability and pricing for XT Intelligent Key T-Handle Cylinders.

(P) = Pinned (combined)

(S) = Sub-assembled (uncombined)

Surcharges for Master Keying, Custom Coining and Custom Stamping apply, see page 196.
Refer to the XT and CLIQ Intelligent Key sections for format availability and pricing.

Cabinet Locks

Medeco® cabinet locks are specifically designed for drawer or cabinet door applications where a conventional utility cam lock may not be suitable. Cabinet locks utilize heavy-duty bolts and multi-point attachment to the mounting surface in order to withstand the heavy use and higher physical security some applications may require. All Medeco cabinet locks feature solid brass and steel construction, available in either fixed or removable core. Patented key programs prevent the unauthorized duplication of keys and maintain system integrity. Keyed alike, keyed different, or master keyed, the Medeco cabinet lock is the perfect solution for your showcase security needs.



Patented Key Control

Protects against unauthorized duplication of your keys.



Available in Intelligent Key

Medeco cabinet locks are also available with Medeco Intelligent Keys for loss & liability control.



Protection From Physical Attack

Medeco³ cabinet locks are UL 437 Listed and stand up to drilling, picking and other forms of physical attack.

Benefits:

- Medeco high security cabinet locks are constructed of durable machined brass and solid steel components.
- Available in either fixed or removable core depending on your specific requirements.
- Available in either deadbolt or spring latch models.
- Unique elevating and rotating tumbler pin system is virtually pick proof.
- Patented Medeco³ keys may only be duplicated by Medeco or an authorized Medeco service outlet, and only at your request.
- Medeco Cabinet Locks can be keyed in with other 60 Series products.
- Locks can be keyed alike, keyed different, or master keyed depending on your specific needs.

Technical Information:

- Five pin models available in either deadbolt or spring latch versions.
- 7/8 inch diameter, surface mount, fixed or removable core available.
- Deadbolt fixed core available in non-key retaining.
- Keyed alike, keyed different, or master keyed.

Warranty:

Warranted for two (2) years against manufacturer's defects. See the Medeco® limited warranty for full details.

Finishes:

- 26 satin chrome finish standard.
- Other finishes available, depending on volume.

Applications:

- Medeco cabinet locks are specifically designed for use in metal or wooden drawer and cabinet door applications including:
 - Medical and narcotics
 - Chests and cabinets
 - Showcases
 - Cash carts
 - Drawers

Available Key Technologies:

Mechanical:

- M³
- X4

Intelligent Key:

- Medeco XT

High Security Cabinet Locks

Description	Part Number	Price
Cabinet Lock with deadbolt, single keypull	6210555T (P)	\$181.57
	6210555T (S)	\$152.57
Cabinet Lock with deadbolt, double keypull	6212555T (P)	\$181.57
	6212555T (S)	\$152.57
Cabinet Lock with spring bolt, single keypull	6211555T (P)	\$201.43
	6211555T (S)	\$172.43
Removable Core Cabinet Lock with deadbolt, single keypull, less plug	6270515	\$97.80
Removable Core Cabinet Lock with spring bolt, single keypull, less plug	6271515	\$110.00
Plug for removable Core Cabinet Lock	66391 (P)	\$109.05
	66391 (S)	\$80.05

Pinned price includes two keys.

SFIC Cabinet Locks

Description	Part Number	Price
Cabinet lock with deadbolt for SFIC cylinder. Works with Medeco X4, Medeco XT SFIC, or Best style SFIC. SFIC ordered separately.	3307311	\$81.80
Cabinet lock with spring bolt for SFIC cylinder. Works with Medeco X4, Medeco XT SFIC, or Best style SFIC. SFIC ordered separately.	3307321	\$81.80
File Cabinet Lock for SFIC cylinder. Works with Medeco X4, Medeco XT SFIC or Best style SFIC Cylinders. SFIC ordered separately.	3307350	\$81.80
Door/Drawer Lock for SFIC cylinder. Works with Medeco X4, Medeco XT SFIC, or best style SFIC. SFIC ordered separately.	3307331	\$81.80

Traffic Cabinet Locks

Description	Part Number	Price
Traffic Cabinet Lock – Medeco ³ – Deadbolt	490435	\$242.44
Traffic Cabinet Lock – Medeco ³ – Slam Bolt	490436	\$244.53

Note: Available through authorized Medeco service centers only.
Traffic Cabinet Locks are available 26 finish only, MM keyway.

511S Cabinet Lock

Formerly offered by ASSA ABLOY ACCENTRA, Medeco 511S cabinet locks are brass locks pinned to electric panel code “47” (4 pin). They are suited for a range of wood or metal wardrobe doors. Medeco’s 511S cabinet lock offering consists of the following three configurations, all keyed to the “47” key number.

Description	Part Number	Price
3/4" RH, 05 Finish, Pinned to “47”	94-51106R-P47-05	\$233.00
1" RH, 26 Finish, Pinned to “47”	94-51108R-P47-26	\$233.00
1-1/8" RH, 26 Finish, Pinned to “47”	94-51109R-P47-26	\$233.00

(P) = Pinned (combined)

(S) = Sub-assembled (uncombined)

Surcharges for Master Keying, Custom Coining and Custom Stamping apply, see page 196.
Refer to the XT and CLIQ Intelligent Key sections for format availability and pricing.

Plunger Locks

Medeco® Plunger Locks are specifically designed for use in wooden or metal sliding doors. Complete with a spring loaded pop out cylinder, the Medeco plunger lock is ideal for security merchandise showcases, metal cabinets, and laboratory and office furniture. Plunger Locks require no key when locking the device; simply push in on the cylinder to relock. Patented key programs prevent the unauthorized duplication of keys and maintain system integrity. Keyed alike, keyed different, or master keyed, the Medeco plunger lock is the perfect solution for your security needs.



Patented Key Control

Protects against unauthorized duplication of your keys.



Can Be Master Keyed

Medeco Plunger Locks can be keyed alike, keyed different or master keyed.



Protection From Physical Attack

Medeco³ Plunger Locks are UL 437 Listed and stand up to drilling, picking and other forms of physical attack.

Benefits:

- Medeco Plunger Locks are constructed of durable machined brass and solid steel components
- Unique elevating and rotating tumbler pin system is virtually pick proof
- Patented Medeco³ keys may only be duplicated by Medeco or an authorized Medeco service outlet, and only at your request
- Medeco Plunger Locks are completely serviceable, and can be re-keyed in case of lost or stolen keys
- Locks can be keyed alike, keyed different, or master keyed depending on your specific needs

Technical Information:

- Four and five pin models available
- Non-key retaining cylinders
- 45 degree clockwise rotation to unlock
- Keyed alike, keyed different or master keyed

Warranty:

Warranted for two (2) years against manufacturer's defects. See the Medeco limited warranty for full details.

Finishes:

- 26 satin chrome finish standard.
- Other finishes available, depending on volume.

Applications:

- Medeco Plunger Locks are specifically designed for use in metal or wooden sliding door applications including:
 - Jewelry and other merchandise showcases
 - Metal cabinets
 - Laboratory furniture
 - Office furniture

Available Key Technologies:

Mechanical: – M³ **Intelligent Key:** – Classic CLIQ

Plunger Locks

Description	Part Number	M3
Plunger Lock, 5 pin round bolt	6221557T (P)	\$200.38
	6221557T (S)	\$171.38
Plunger Lock, 5 pin glass mount	6261557T (P)	\$233.82
	6261557T (S)	\$204.82
Plunger Lock, 4 pin round bolt	6221554T (P)	\$200.38
	6221554T (S)	\$171.38

Pinned price includes two keys.

Micro Switch Locks

Medeco's 3/4" diameter, high security Switch Locks offer a wide range of electrical functions with the physical security and patented key control of a Medeco cylinder. Available in either single or double switch models, Medeco Switch Locks are ideally suited for applications requiring controlled access to electrically activated systems, including alarms, ATMs, time delay safes, encryption devices, heavy power equipment, control panels and electrically accessed doors and gates. The Medeco³ unique design provides triple locking action, making the locks virtually pick proof. All Medeco³ keys and locks are protected by trademark and copyright laws. Medeco keys may only be duplicated by Medeco or by an authorized Medeco dealer, and only at your request.

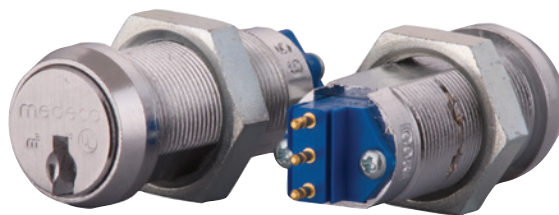

Patented Key Control

Protects against unauthorized duplication of your keys.



Can Be Master Keyed

Medeco Switch Locks can be keyed alike, keyed different or master keyed.



Protection From Physical Attack

Medeco³ Switch Locks are UL 437 Listed and stand up to drilling, picking and other forms of physical attack.

Benefits:

- All Medeco cylinders are constructed of durable machined brass components, designed to last the life of your equipment.
- Available in single or double switch models, momentary and maintained positions.
- Silver or gold contacts (for low amperage applications) designed to accept quick connect leads.
- Hardened stainless steel inserts inside the cylinder provide the ultimate defense against drilling and other forms of physical attack.
- Unique elevating and rotating tumbler pin system is virtually pick proof.
- Medeco³ keys may only be duplicated by Medeco or an authorized Medeco service outlet, and only at your request.
- Medeco Switch Locks are completely serviceable, and can be re-keyed in case of lost or stolen keys.
- Locks can be keyed alike, keyed different, or master keyed depending on your specific needs.

Certification:

- UL 437 Listed
- Switch - UL Registered, CSA Certified

Applications:

- Medeco High Security Switch Locks can be used in any standard 3/4 inch diameter switch lock application and a multitude of markets including:
 - Heavy Power Machinery
 - Time Delay Safes
 - Material Handling Equipment
 - Construction Vehicles
 - Electrically Accessed Gates
 - Cash Control Systems
 - Encryption Devices
 - Alarms
 - Control Panels
 - ATMs

Warranty:

Warranted for two (2) years against manufacturer's defects. See the Medeco® limited warranty for full details.

Technical Information:

- Five pin, 3/4 inch double "D" mounting standard.
- Available in either single or double switch models with either silver or gold contacts.
- Rated at 7 amps resistive at 125/250 VAC.
- Contacts designed to accept quick connect leads (AMP connector number 60598-3)

Finishes:

- 26 satin chrome finish standard.
- Other finishes available, depending on volume.

Available Key Technologies:

Mechanical:

– M³

Single Switch Locks

Description	Part Number	M3
1 switch, maintained 1 keypull	652150T 011 (P)	\$169.03
	652150T 011 (S)	\$140.03
1 switch, maintained 2 keypull	652150T 012 (P)	\$169.03
	652150T 012 (S)	\$140.03
1 switch, momentary 1 keypull	652150T 021 (P)	\$169.03
	652150T 021 (S)	\$140.03

Pinned price includes two keys.

Double Switch Locks

Description	Part Number	M3
2 position, maintained, 1 keypull	652650T 101 (P)	\$274.57
	652650T 101 (S)	\$245.57
2 position, maintained, 2 keypull	652650T 102 (P)	\$274.57
	652650T 102 (S)	\$245.57
2 position, momentary, 1 keypull	652650T 111 (P)	\$274.57
	652650T 111 (S)	\$245.57
3 position, maintained, 1 keypull	652650T 131 (P)	\$274.57
	652650T 131 (S)	\$245.57
3 position, maintained, 2 keypull	652650T 132 (P)	\$274.57
	652650T 132 (S)	\$245.57
3 position, maintained, 3 keypull	652650T 133 (P)	\$274.57
	652650T 133 (S)	\$245.57

Pinned price includes two keys.

Switch Lock Accessories for 652150 and 652650

Description	Part Number	Price
Silver Sub Miniature Snap Action Switch: Double Pole/Double Throw	CP-150082	\$74.20
Gold Sub Miniature Snap Action Switch: Double Pole/Double Throw	CP-150102	\$98.40
Sleeve Kit: Includes chrome plated zinc sleeve with rubber grommet, plain washer, 1 pronged washer locks for mounting Cam Locks in harsh environments.	650003	\$54.10
Silver Sub Miniature Snap Action Switch: Single Pole-Single or Double Throw	CP-150142	\$37.40
Gold Sub Miniature Snap Action Switch: Single Pole-Single or Double Throw	CP-150152	\$53.50
4" Leadwire	CP-270511	\$2.60
6" Leadwire	CP-270521	\$3.00
12" Leadwire	CP-270531	\$3.81
18" Leadwire	CP-270541	\$4.78
24" Leadwire	CP-270551	\$10.20
36" Leadwire	CP-270561	\$10.20
3/4" hex nut for Switch Locks	CP-050050	\$3.55

(P) = Pinned (combined)

(S) = Sub-assembled (uncombined)

Surcharges for Master Keying, Custom Coining and Custom Stamping apply, see page 196.
Refer to the XT and CLIQ Intelligent Key sections for format availability and pricing.

Rotary Switch Locks

The Medeco® rotary Switch Locks is designed for use with most brands of rotary switches, providing maximum versatility in systems requiring multiple switch functions. Switch Locks are available with a variety of key withdrawals at 45° increments. Positive stops are available to eliminate over-torquing of switch stops. Switch Locks use a five pin cylinder to maximize keyed different and master keying capabilities. Medeco design and engineering resources are available to assist customers with special functional requirements. The Medeco³ unique design provides triple locking action, making the locks virtually pick proof. All Medeco³ keys and locks are protected under patent, trademark and copyright laws. Medeco³ keys may only be duplicated by Medeco or by an authorized Medeco dealer, and only at your request.



Patented Key Control

Protects against unauthorized duplication of your keys.



Available in Intelligent Key

Medeco Switch Locks are also available with Medeco Intelligent Keys for loss & liability control.



Can Be Master Keyed

Medeco switch locks can be keyed alike, keyed different or master keyed.



Protection From Physical Attack

Medeco³ switch locks stand up to drilling, picking and other forms of physical attack.

Benefits:

- All Medeco cylinders are constructed of durable machined brass components, designed to last the life of your equipment.
- Hardened stainless steel inserts inside the cylinder provide the ultimate defense against drilling and other forms of physical attack.
- Unique elevating and rotating tumbler pin system is virtually pick proof.
- Patented Medeco³ keys may only be duplicated by Medeco or an authorized Medeco service outlet, and only at your request.
- Medeco Switch Locks are completely serviceable, and can be re-keyed in case of lost or stolen keys.
- Locks can be keyed alike, keyed different, or master keyed depending on your specific needs.

Warranty:

Warranted for two (2) years against manufacturer's defects. See the Medeco limited warranty for full details.

Technical Information:

- Five pin, 3/4 inch double "D" mounting standard.

Finishes:

- 26 satin chrome finish standard.
- Other finishes available, depending on volume.

Certification:

- Switch - UL Registered, CSA Certified

Applications:

- Medeco Rotary Switch Locks can be used to retrofit many Switch Lock applications including:
 - Heavy Power Machinery
 - Time Delay Safes
 - Material Handline Equipment
 - Construction Vehicles
 - Electrically Accessed Gates
 - Cash Control Systems
 - Encryption Devices
 - Alarms
 - Control Panels
 - ATMs

Available Key Technologies:

Mechanical:

– M³

Intelligent Key:

– Medeco XT

Operation Codes

Description	Part Number	M3
2 position, 1 keypull A, maintained at B	6522560T 121 (P)	\$164.85
	6522560T 121 (S)	\$135.85
2 position, 2 keypull A&B, maintained	6522560T 122 (P)	\$164.85
	6522560T 122 (S)	\$135.85
3 position, 2 keypull A&B, maintained	6522560T 132 (P)	\$164.85
	6522560T 132 (S)	\$135.85
3 position, 3 keypull A, B&C, maintained	6522560T 133 (P)	\$164.85
	6522560T 133 (S)	\$135.85
3 position, 2 keypull A&C, maintained at B	6522560T 134 (P)	\$164.85
	6522560T 134 (S)	\$135.85
2 position, 1 keypull A, momentary at B	6522560T 221 (P)	\$164.85
	6522560T 221 (S)	\$135.85

Pinned price includes two keys.

(P) = Pinned (combined)

(S) = Sub-assembled (uncombined)

Surcharges for Master Keying, Custom Coining and Custom Stamping apply, see page 196.
Refer to the XT and CLIQ Intelligent Key sections for format availability and pricing.

International Cylinders

Medeco's international cylinders are designed to fit in locksets of major world manufacturers. In addition to international uses, many of these cylinders fit imported hardware used in North America. Medeco offers a variety of international cylinders including European profile and modular cylinders in both mechanical and Intelligent Key technologies. The Medeco European Profile cylinder has a teardrop shape that fits into storm doors, upscale hardware and specialty applications and is available in single, half and double cylinder versions. Cylinders are also available in: oval, round, and "snowman" formats.



Patented Key Control

Patent-pending key control protects against unauthorized duplication of keys (Medeco 4*).



Protection Against 3D Printing

A patent-pending movable element in the M4* key deters unauthorized 3D printed copies of keys or blanks.



Picking and Bumping Protection

M4* cylinders use cylinder side pins, a lift pin and a movable key element to engage a sidebar that prevents the key from turning until the elements are rotated and aligned in the correct position, protecting against bumping, picking and other attacks.



Protection From Physical Attack

M4* cylinders are UL 437 Listed and use hardened steel inserts positioned in critical areas of the cylinder, providing a high degree of drill and picking resistance (For the highest grade of protection, Euro Profile cylinders and Ovals – should be installed with hardened escutcheons.).



Special Angle Cut Keys

Requires a special key cutting machine and access to Medeco specific blanks, available in a variety of restrictions to support every need.



Intelligent Key Cylinders

Medeco's international cylinders are also available in electronic Intelligent Key format for loss & liability control.



Master Keying Capabilities

M4* international-style cylinders can be master keyed into a system containing M4 and M4 BiLevel.

Technical Information:

- Utility patented key control provides protection from unauthorized duplication of keys in most countries (M4*, M3)
- Superior master keying capability to accommodate systems of virtually any size
- Solid brass construction provides high quality and long cylinder life
- Nickel plated pins provide exceptional wear resistance and additional hardened stainless steel pins provide drill resistance
- European profile cylinders retrofit into virtually any manufacturers' locksets requiring DIN Standard cylinders
- Pin chamber set screws provide ease of rekeying and resist comb attacks
- 5 and 6 pin cylinders available

Certification (M4 Pending):

- SKG *** Netherlands
- Swedish Standards SS3522
- EN1303 -2005
- DIN18254
- EN1303:2015

Warranty:

Warranted for two (2) years against manufacturer's defects. See the Medeco® limited warranty for full details

Available Key Technologies:

Mechanical:

- M4/M4 BiLevel
- M³/M³ BiLevel
- X4

Intelligent Key:

- M³ CLIQ
- Classic CLIQ
- XT
- X4 CLIQ

Note: M3 and M4 BiLevel not available in Euro Dbl.

EPIC–Euro Profile Interchangeable Core

Medeco EPIC-Euro Profile cylinders are designed to accept a special, slab-sided, small format interchangeable core (SFIC) cylinder to retrofit into most standard European Profile applications.

Medeco Euro profiles can be furnished with Medeco's patented X4 technology, offering unmatched key control, the widest array of retrofit cylinders and four times the master keying capability.



Patented Key Control

Protects against unauthorized duplication of your keys.



Uses Existing Hardware

European profile cylinders retrofit into virtually any manufacturers' locksets requiring DIN Standard cylinders.



Superior Master Keying Capability

Furnished with Medeco X4 SFIC, EPIC offers superior master keying to accommodate very large systems.

Medeco X4 Technical Information

- 6 and 7 Pin cylinders available
- Solid nickel silver pins
- Many cylinder formats available
- Profile cylinders available in multiple sizes, finishes and functions
- Where interchangeable core is not required, Euro profile cylinders are also available in modular components and assembled standard lengths.
- Solid brass construction provides high quality and long cylinder life
- Solid nickel silver pins and keys
- European Profile Cylinders retrofit into virtually any manufacturers' locksets equivalent to DIN Standards
- For the highest grade of protection, Euro Profile cylinders and Ovals – should be installed with hardened escutcheons

Warranty

Warranted for (2) years against manufacturing defects. See Medeco Limited Warranty for full details.

EPIC–Euro Profile Interchangeable Core

Description	Part Number	Price
6 Pin Part Numbers		
EPIC Euro Double 37.9 mm/37.9mm	2326D21	\$128.00
EPIC Euro Half 37.9mm	2326H01	\$83.70
EPIC Euro with Thumbturn 40mm int/39.2 mm ext	2326S12X*	\$121.00
Small Format Interchangeable Core (SFIC)	3360000R (P)	\$94.10
Small Format Interchangeable Core (SFIC)	3360000R (S)	\$77.60
7 Pin Part Numbers		
EPIC Euro Double 41.73mm/41.73mm	2324D21	\$128.00
EPIC Euro Double 41.73mm/55mm	2324D25	\$128.00
EPIC Euro Half 41.73mm	2324H01	\$83.70
EPIC Euro Half 55mm	2324H05	\$83.70
EPIC with Thumbturn 40mm int/43mm ext	2324S12X	\$121.00
EPIC with Thumbturn 40mm int/55mm ext	2324S15X	\$121.00
EPIC with Thumbturn 55mm int/43mm ext	2324S52X	\$121.00
Small Format Interchangeable Core (SFIC)	3370000R (P)	\$94.10
Small Format Interchangeable Core (SFIC)	3370000R (S)	\$77.60

* X denotes thumb turn. Please see following page for thumb turn. EPIC sold less cylinder.

(P) = Pinned (combined)

(S) = Sub-assembled (uncombined)

Surcharges for Master Keying, Custom Coining and Custom Stamping apply, see page 196.
Refer to the XT and CLIQ Intelligent Key sections for format availability and pricing.

How To Order International Cylinders - Euro-Profile

<p>1</p> <p>23130 05500 base part # example</p> <p>Refer to pages 178-180 for descriptions and technical specifications to find the corresponding base part number.</p>	<p>2</p> <p>H technology</p> <p>H = M4 P = M4 BiLevel T = M³ J = M³ BiLevel S = M³ CLIQ W = Biaxial - = Original K = KM C = Classic CLIQ N = X4 M = X4 CLIQ</p>	<p>3</p> <p>05 finish</p> <p>Refer to the inside back cover of this catalog for finish options.</p>	<p>4</p> <p>M4 keyway</p> <p>Insert keyway if known or contact Customer Service for help.</p>	<p>5</p> <p>P pinning</p> <p>S = Sub-Assembled (Uncombined) N = Sub-assembled, - No side pins (M4 only) - No slider (M3 only) P = Pinned (Combinated) M = Master Keyed R = Master Keyed - blade and side pins (Medeco 4 only)</p>	<p>6</p> <p>624 side pin code (Medeco 4 only)</p> <p>Insert side pin code if known or contact Customer Service for help.</p>
---	---	--	--	--	--

BUILD A BASE PART #:

23130 X X X X X X

International Cylinder ————┐

Profile Design —————┐

Function —————┐

- *0 = Thumbturn Cylinder with "SR" Round Knob
- 1 = Half Cylinder
- 2 = Double Cylinder*
- *3 = Thumbturn Cylinder with Low Profile "LP" Knob
- *4 = Thumbturn Cylinder with Decorative "RD" Knob
- *5 = Thumbturn Cylinder with Lever "RL" Knob
- *6 = Thumbturn Cylinder with "CR" Crescent Knob
- *7 = Thumbturn Cylinder with "SP" Spade Knob
- *L = Thumbturn Cylinder with "L" Less Knob

Number of Pins —————┐

- 5 = 5 Pins
- 6 = 6 Pins
- 7 = 7 Pins

*Not available in M3 & M4 BiLevel

Interior/Exterior Length Extensions

0 = No Extension	5 = 25 mm (.984")
1 = 5 mm (.197")	6 = 30 mm (1.18")
2 = 10 mm (.394")	7 = 35 mm (1.38")
3 = 15 mm (.591")	8 = 40 mm (1.57")
4 = 20 mm (.787")	9 = 45 mm (1.77")

Cam Position
(from outside with bible down)

- 1 = 1 o'clock
- 2 = 10 point multi-gear
- 3 = EuroLine Module
- 5 = 5 o'clock
- 7 = 7 o'clock
- 8 = Multiposition (half cylinder only)
- 0 = 11 o'clock

*Thumbturn/Cam position available at 5 and 11 o'clock only

Assembly Variation for the BiLevel with Original Technology

- H = High Security
- B = Standard Security
- J = Standard Security all except Double Euro Profile

How To Order Other International Cylinders

Complete part numbers are required for all orders. To determine the correct part number, fill in the "X's" in sequential order.

<p>1</p> <p>2305016 base part # example</p> <p>Refer to pages 181-184 for descriptions and technical specifications to find the corresponding base part number.</p>	<p>2</p> <p>H technology</p> <p>H = M4 P = M4 BiLevel T = M³ J = M³ BiLevel S = M³ CLIQ W = Biaxial - = Original K = KM C = Classic CLIQ N = X4 M = X4 CLIQ</p>	<p>3</p> <p>05 finish</p> <p>Refer to the inside back cover of this catalog for finish options.</p>	<p>4</p> <p>M4 keyway</p> <p>Insert keyway if known or contact Customer Service for help.</p>	<p>5</p> <p>P pinning</p> <p>S = Sub-Assembled (Uncombined) N = Sub-assembled, - No side pins (M4 only) - No slider (M3 only) P = Pinned (Combinated) M = Master Keyed R = Master Keyed - blade and side pins (Medeco 4 only)</p>	<p>6</p> <p>624 side pin code (Medeco 4 only)</p> <p>Insert side pin code if known or contact Customer Service for help.</p>
---	--	---	---	---	--

BUILD A BASE PART #:

23 XXX XXX X

International Cylinder

Design

- 010 = Danish Round (Ruko Round)
- 030 = Australian Oval
- 040 = British Oval (Union Oval)† No extension.*
- 050 = Scandinavian Oval Ext. (ASSA Oval)
- 060 = Scandinavian Oval Int. (ASSA Oval)
- 070 = Norwegian Oval (TrioVing Oval)
- 080 = Scandinavian Snowman
- 090 = Scandinavian Round Ext. (ASSA Round)
- 100 = Scandinavian Round Int. (ASSA Round)
- 140 = Italian Outer Gate Lock, 3 Pin
- 150 = Italian Outer Gate Lock, 5 Pin
- 160 = Italian Roller Shutter, 4 Pin

Function*

- 0 = Thumbturn Cylinder with "RL" Knob Union Oval only
- 1 = Half Cylinder
- 2 = Double Cylinder

† Union Oval Thumbturn Position at 5 and 11 o'clock only.

*British Oval is the only design that requires a function number and cam position to be selected. It is non-extending.

Cam Position (British Oval)*

- 0 = 11 o'clock
- 1 = 1 o'clock
- 5 = 5 o'clock
- 7 = 7 o'clock

BiLevel w/ Original Technology

- H = High Security
- B = Standard Security

Number of Pins

- 3 = 3 Pins
- 4 = 4 Pins
- 5 = 5 Pins
- 6 = 6 Pins

Medeco Premium High Security Euro Thumbturn Profile Cylinder

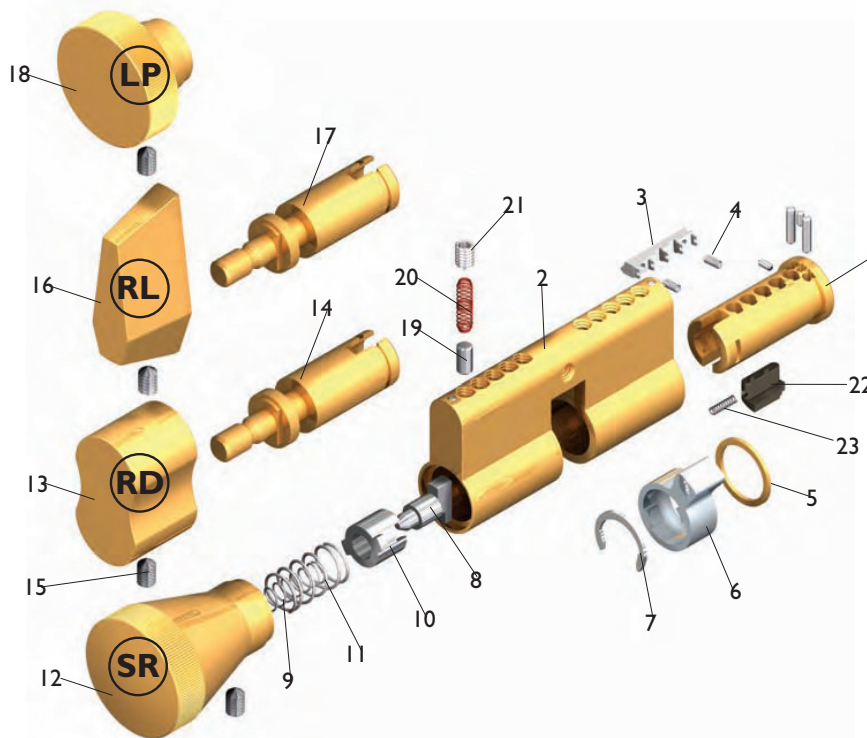

Item	Description	Part Number
1	Plug	Cylinder Specific
2	Shell	Cylinder Specific
3	Sidebar	CP-084X71
4	Sidebar Springs	CP-030018
5	Plug Retainer Ring	CP-021490
6	Cam	CT-Z51
7	Thumbturn Retaining Clip	CP-020031
8	Actuator	CP-100111
9	Actuator Spring	CP-030025
10	Actuator Pilot	CP-280261
11	Pilot Spring	CP-030024
12	Standard Round "SR" Thumbturn	CP-285961
13	Decorative "RD" Thumbturn	CP-285901
14	Thumbturn Shaft - 6 Pin	CP-240761-600
15	Thumbturn Allen Set Screw #6-32 x 3/16" Knurled Cup Point	CP-012411-040
16	Lever "RL" Thumbturn	CP-285931
17	Thumbturn Shaft - 5 Pin	CP-240761-500
18	Low Profile "LP" Thumbturn	CP-285991
19	Thumbturn Retaining Pin	TP-F10-1T
20	Thumbturn Retaining Pin Spring	CP-030001
21	Thumbturn Retaining Pin Allen Set Screw #8-32 x 1/4"	CP-011013-040
22	Slider (varies related to keyway)	CP-084591
23	Slider Spring	CP-030910
24	Spade Thumbturn (Pictured on page 180 "Special Order") "SP"	CP-286051
25	Crescent Thumbturn (Pictured on page 180 "Special Order") "CR"	CP-286021

Medeco Premium High Security Euro Half Profile Cylinder

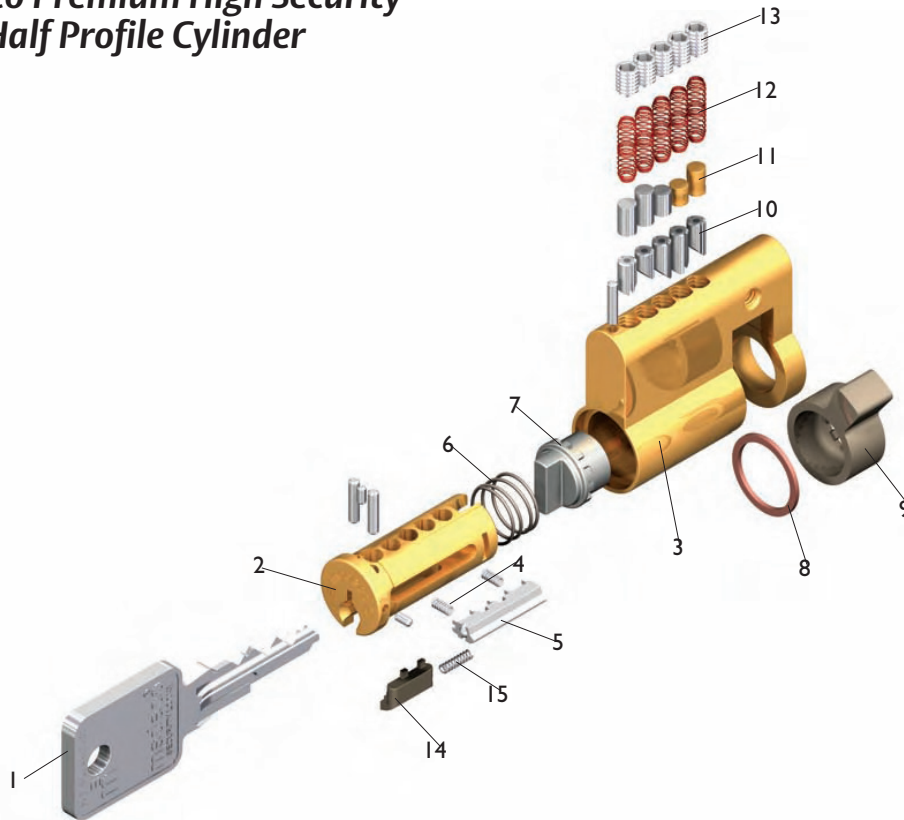

Item	Description	Part Number
1	Key	As Required
2	Plug	Cylinder Specific
3	Shell	Cylinder Specific
4	Sidebar Springs	CP-030018
5	Sidebar	CP-084X71
6	Cam Spring	CP-030860
7	Actuator	CP-220090
8	Plug Retainer	CP-021490
9	Cam	CT-Z88
10	Bottom Pins	As Required
11	Top Pins	As Required
12	Springs (Phosphor Bronze)	CP-030001
13	Pin Chamber Allen Set Screws #8-32 x 1/4"	CP-011013-040
14	Slider - (varies related to keyway)	CP-084591
15	Slider Spring	CP-030910

Medeco Premium High Security Exterior Scandinavian Oval Cylinder

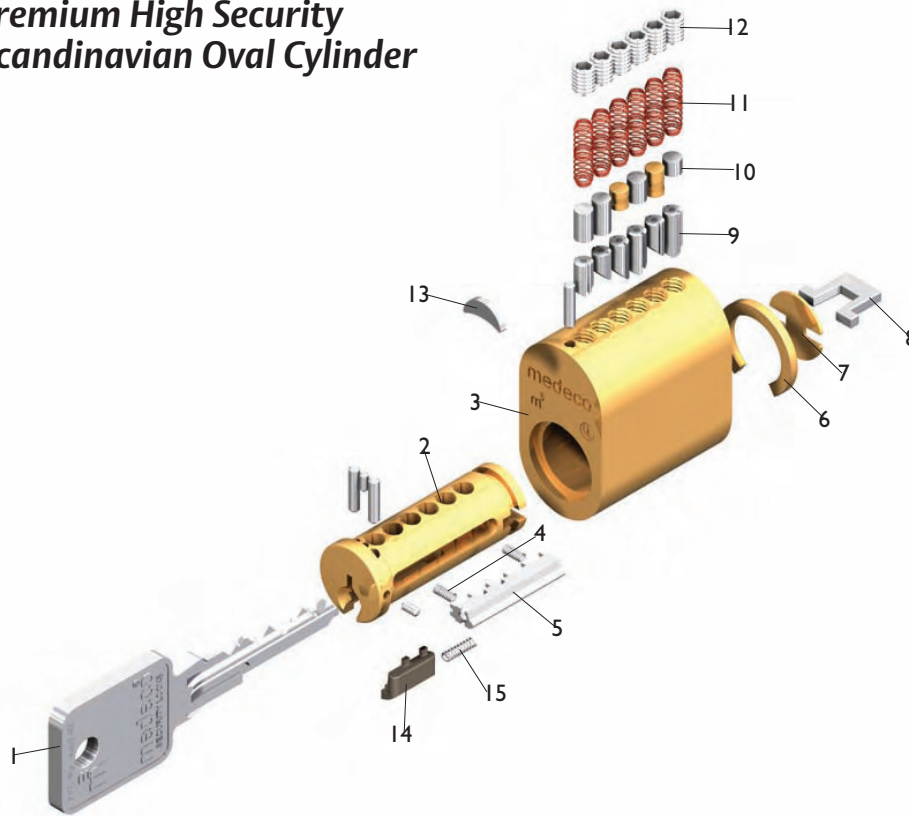

Item	Description	Part Number
1	Key	As Required
2	Plug	Cylinder Specific
3	Shell	Cylinder Specific
4	Sidebar Springs	CP-030018
5	Sidebar, 6 Pin	CP-084671
6	Plug Retainer	CP-021040
7	Plate	CP-180830
8	Tailpiece	CT-Y76
9	Bottom Pins	As Required
10	Top Pins	As Required
11	Springs (Phosphor Bronze)	CP-030001
12	Pin Chamber Allen Set Screws #8-32 x 1/4"	CP-0111013-040
13	Crescent Steel Insert	CP-180011
14	Slider – (varies related to keyway)	CP-084591
15	Slider Spring	CP-030910

Medeco Premium High Security Interior Scandinavian Oval Cylinder

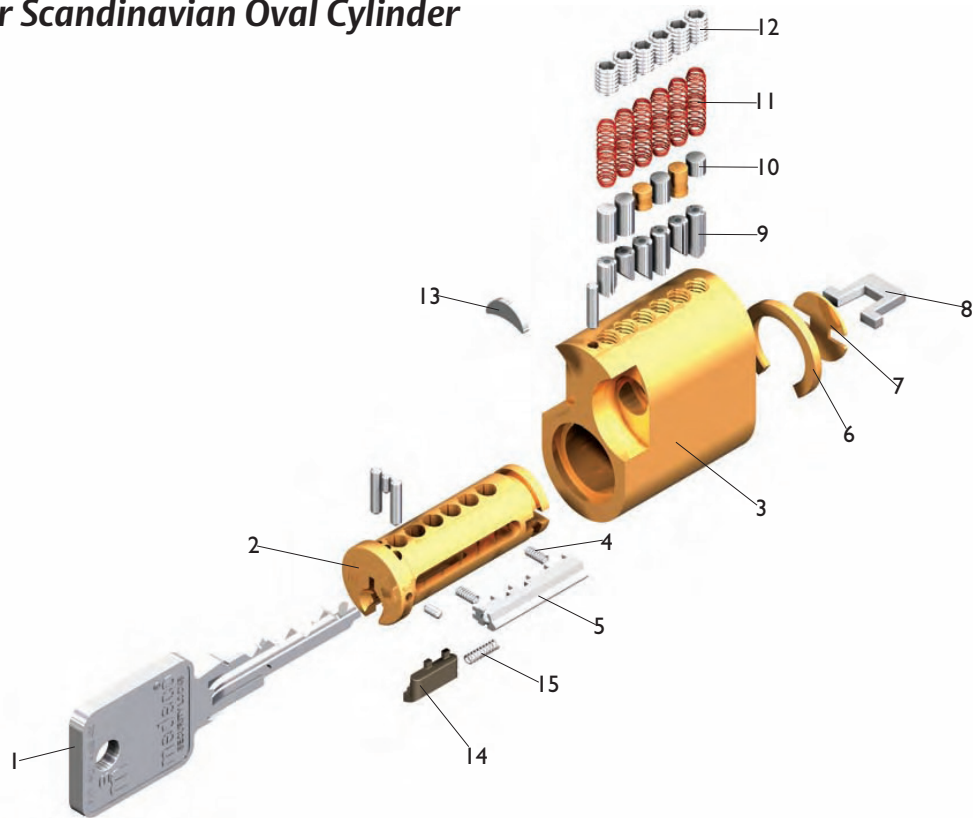

Item	Description	Part Number
1	Key	As Required
2	Plug	Cylinder Specific
3	Shell	Cylinder Specific
4	Sidebar Springs	CP-030018
5	Sidebar, 6 Pin	CP-084671
6	Plug Retainer	CP-021040
7	Plate	CP-180830
8	Tailpiece	CT-Y76
9	Bottom Pins	As Required
10	Top Pins	As Required
11	Springs (Phosphor Bronze)	CP-030001
12	Pin Chamber Allen Set Screws #8-32 x 1/4"	CP-011013-040
13	Crescent Steel Inserts	CP-180011
14	Slider – (varies related to keyway)	CP-084591
15	Slider Spring	CP-030910

Medeco Premium High Security Euro Double Profile

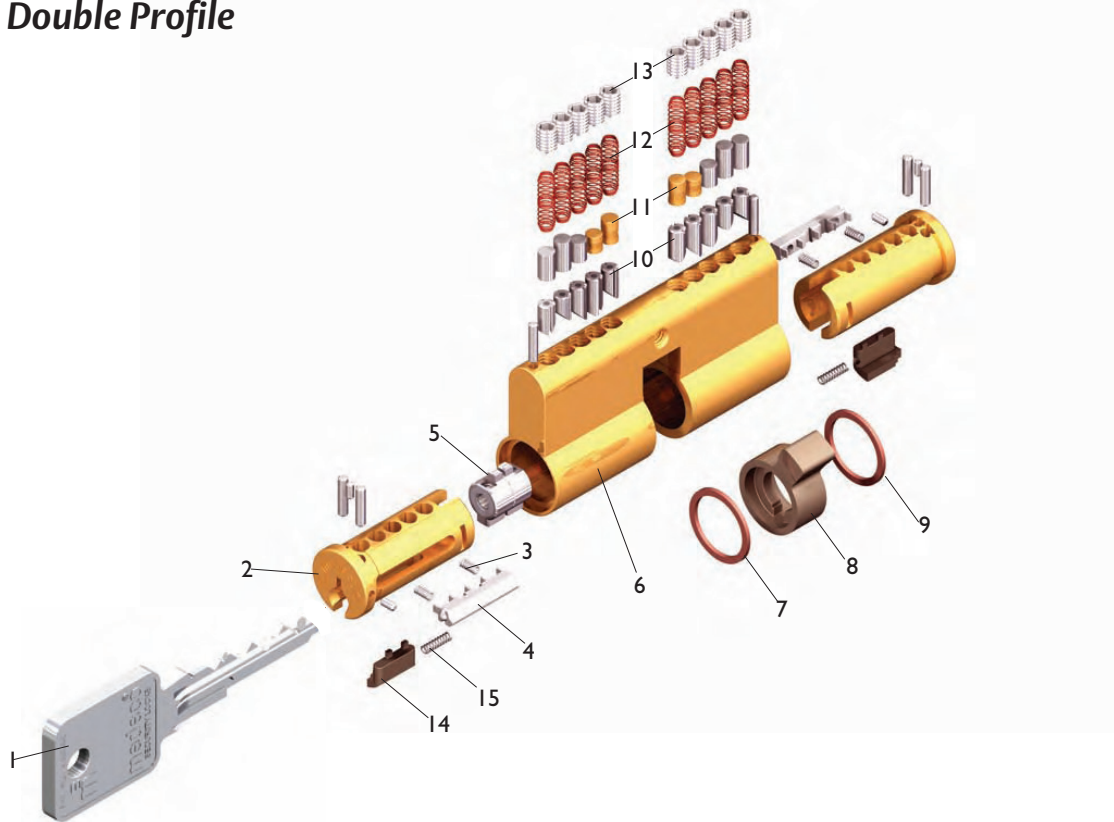

Item	Description	Part Number
1	Key	As Required
2	Plug	Cylinder Specific
3	Sidebar Springs	CP-030018
4	Sidebar, 5 Pin	CP-084571
5	Clutch	CP-220071
6	Shell	Cylinder Specific
7	Plug Retainer	CP-021490
8	Cam	CT-Z50
9	Plug Retainer	CP-021490
10	Bottom Pins	As Required
11	Top Pins	As Required
12	Springs (Phosphor Bronze)	CP-030001
13	Pin Chamber Allen Set Screws #8-32 x 1/4"	CP-0110113-040
14	Slider – (varies related to keyway)	CP-084591
15	Slider Spring	CP-030910

Medeco Premium High Security EuroLine Modular Profile Cylinder System

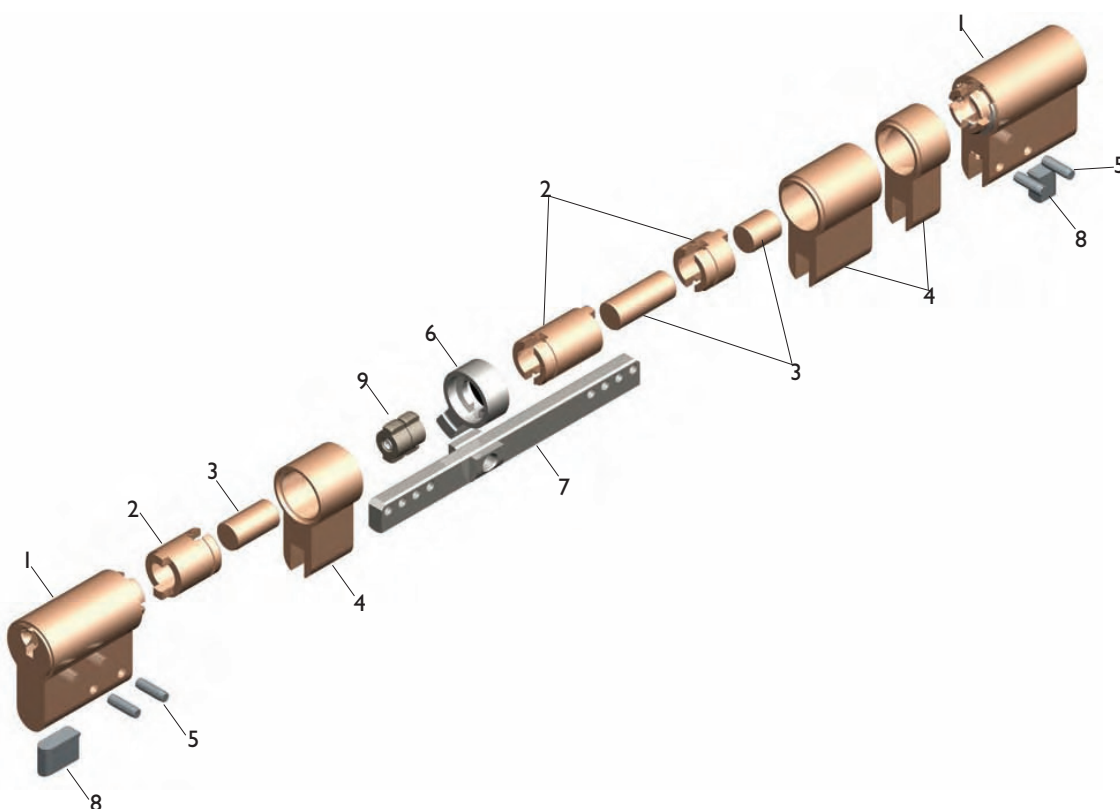

Modular Profile Double Cylinder

Item	Description	Part Number
1	Cylinder Module (5 or 6 Pin)	232201X 30X
2	Outer Plug Extension - 10mm – 25mm extensions available	CP-200751
3	Inner Plug Extension - 5mm – 25mm extensions available	CP-200761
4	Brass Shell Extension - finish required	CP-200771
5	Groove Pins	CP-063220
6	Cam	CT-Z50
7	Connecting Bar - requires length designation	CP-200801
8	Bar Filler	CP-160661
9	Clutch Assembly	CP-220071

Medeco Premium High Security EuroLine Modular Profile Cylinder System

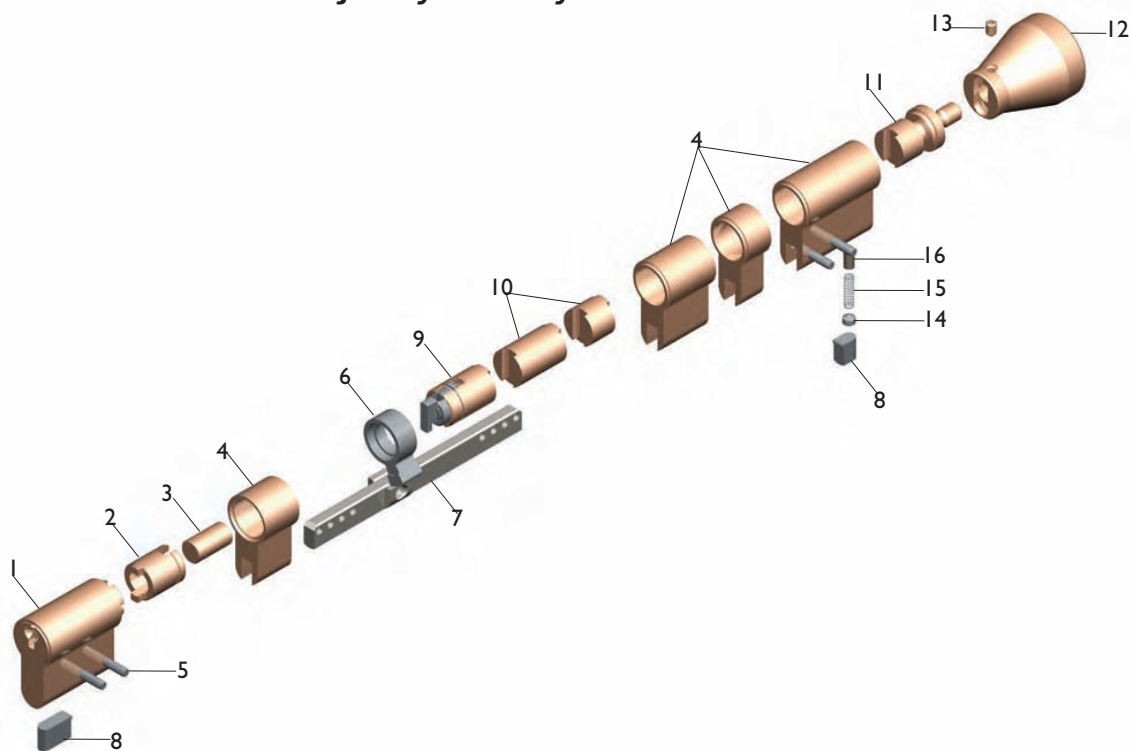

Modular Profile Single Cylinder with Thumbturn

Item	Description	Part Number
1	Thumbturn Cylinder Module (5 or 6 pin), requires knob selection	23X220XX-300
2	Outer Plug Extension, 10-25 mm extension	CP-200751
3	Inner Plug Extension, 5-25 mm extension	CP-200761
4	Brass Shell Extension, Finish required	CP-200771
5	Groove Pins	CP-063220
6	Cam	CP-Z51
7	Connecting Bar	CP-200801
8	Bar Filler	CP-160661
9	Thumbturn Actuator Cartridge	CP-220131
10	Thumbturn Cartridge Extension, 5-25 mm extension	CP-200781
11	Thumbturn Shaft – Modular Only	CP-240771-XP
12	Thumbturn Knob	See Page 181
13	Thumbturn Set Screw	CP-011013-020
14	Thumbturn Retaining Set Screw 8- 32 x 1/4"	CP-011013-040
15	Thumbturn Retaining Pin Spring	CP-030001
16	Thumbturn Retaining Pin	TP-F10-IT

Euro Profile Technical Information

A = Total Length
B = Interior Length

C = Exterior Length
KP = Knob to Face

EURO PROFILE SINGLE CYLINDER WITH THUMBTURN

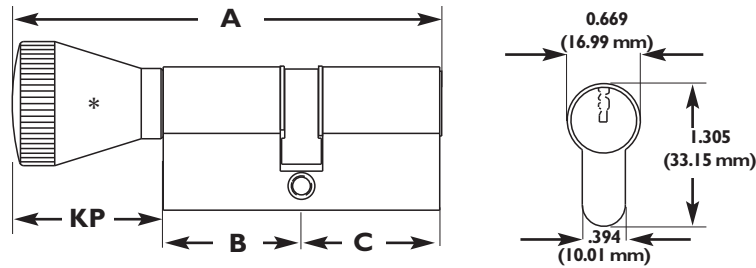

Euro Profile Single Cylinder with Thumbturn

Part#	A	B	C	KP
2313005 X00 *	99.04	31.98	31.98	35.08
2313035 X00	81.44	31.98	31.98	17.48
2313045 X00	83.09	31.98	31.98	19.13
2313055 X00	84.1	31.98	31.98	20.14
2313006 X00 *	107.68	36.3	36.3	35.08
2313036 X00	90.08	36.3	36.3	17.48
2313046 X00	91.73	36.3	36.3	19.13
2313056 X00	92.74	36.3	36.3	20.14
2313065 X00 (490264)	84.3	31.98	31.98	20.35
2313066 X00 (490291)	92.94	36.3	36.3	20.35

Euro Profile Technical Information

A = Total Length
B = Interior Length

C = Exterior Length

EURO PROFILE DOUBLE CYLINDER

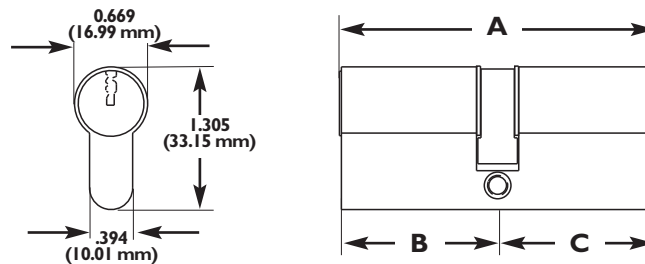

Euro Profile Double Cylinder with Thumbturn

Part#	A	B	C
2313025 X00	63.96	31.98	31.98
2313026 X00	72.59	36.3	36.3
2313025 X01	68.96	31.98	36.98
2313025 X02	73.96	31.98	41.99
2313025 X11	73.96	36.98	36.98
2313025 X12	78.97	36.98	41.99
2313026 X01	77.6	36.3	41.3
2313026 X02	82.6	36.3	46.3
2313026 X12	87.6	41.3	46.3

All table measurements in millimeters.

Euro Profile Technical Information

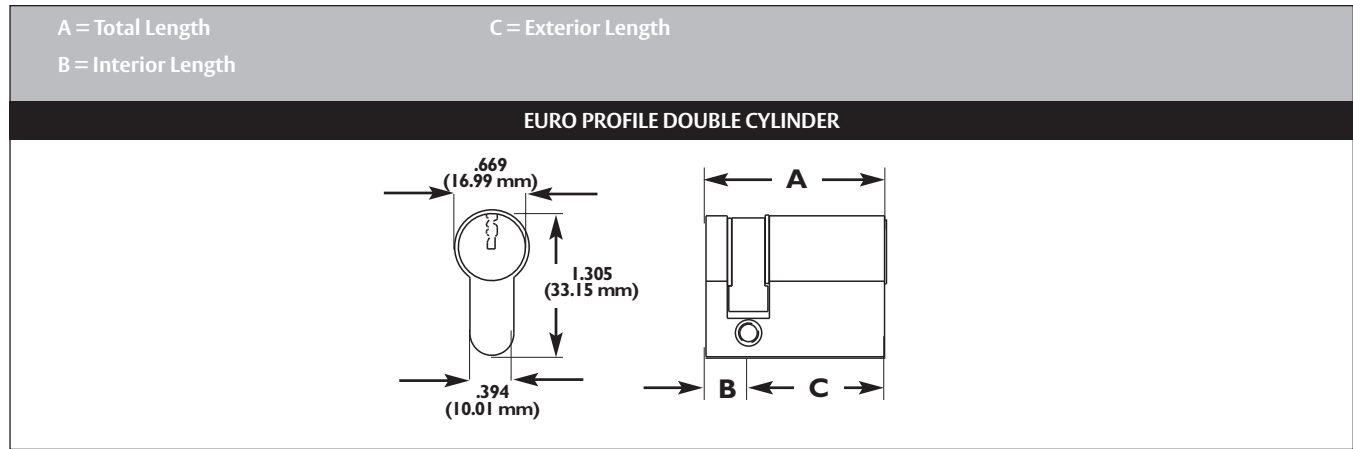

Euro Profile Single Cylinder with Thumbturn

Part#	A	B	C
2313015 800	41.99	10.01	31.98
2313016 800	46.4	10.01	36.3
2313015 801	46.99	10.01	36.98
2313016 801	51.31	10.01	41.3

All table measurements in millimeters.

Euro Profile Technical Information

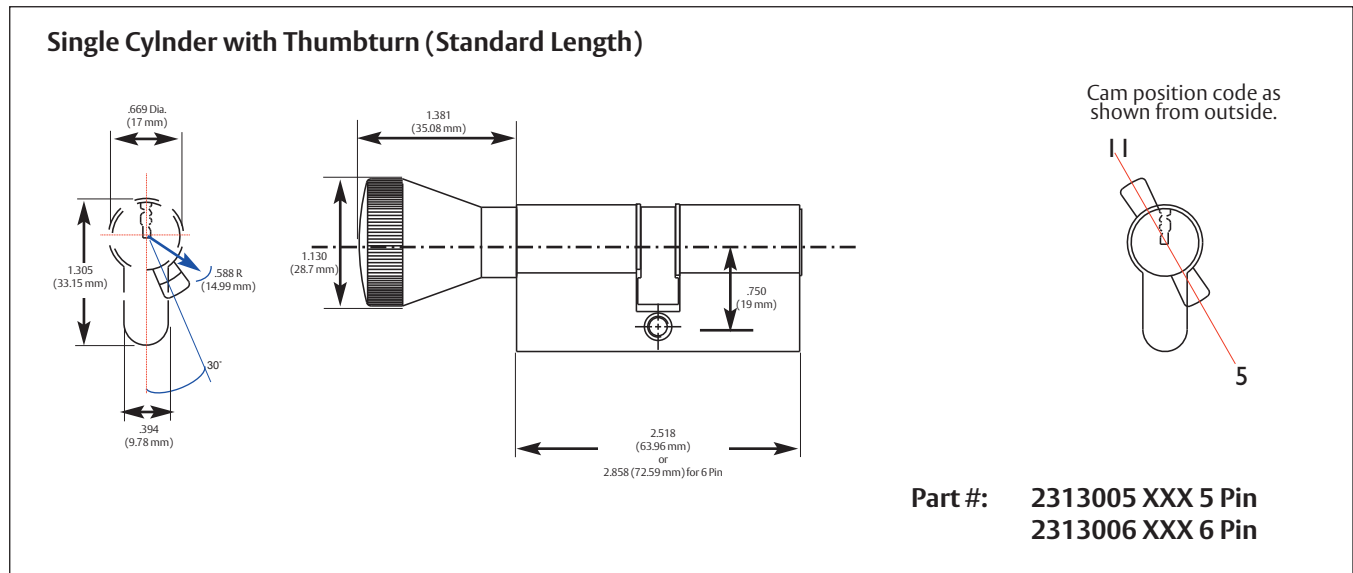

Half Cylinder (Standard Length)

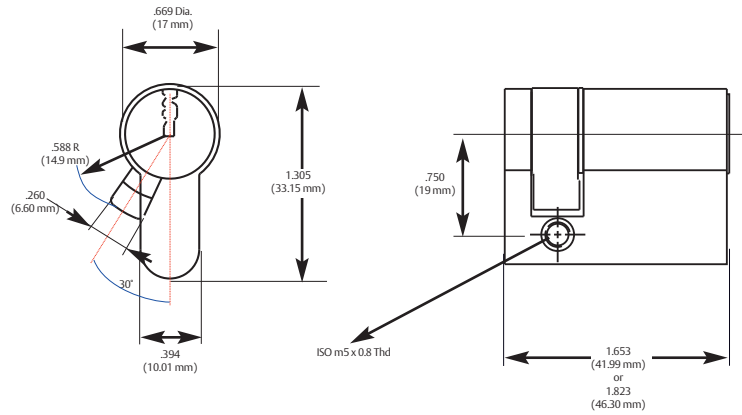

Cam position code as shown from outside.

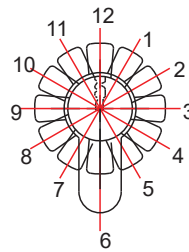

Multi-indexing cam with 12 positions. Cam is set at 5 o'clock from the factory

Part #: 2313015 8XX 5 Pin
2313016 8XX 6 Pin

Double Cylinder 5 Pin (Standard and Extended)

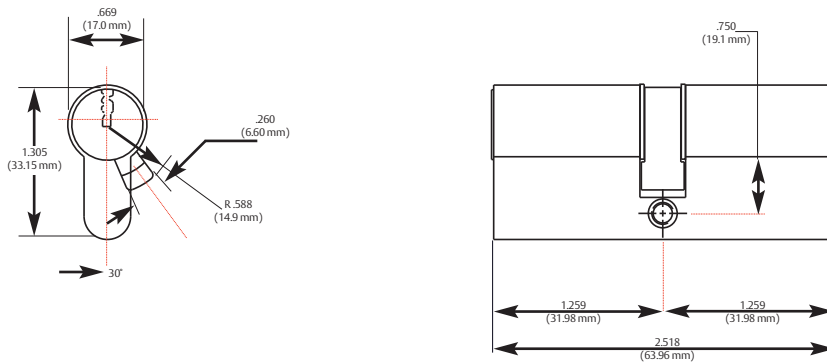

Cam position code as shown from outside.

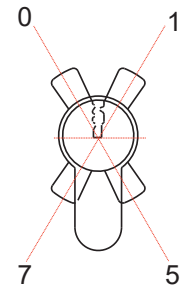

Part #: 2313025 X00 5 Pin
In 5mm steps up to 45mm

Double Cylinder 6 Pin (Standard and Extended)

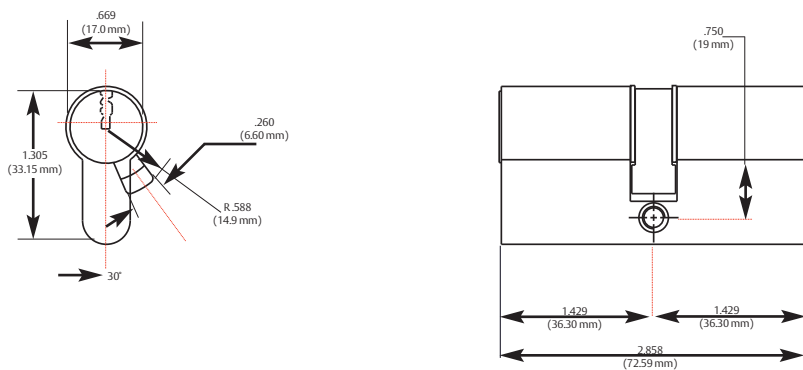

Cam position code as shown from outside.

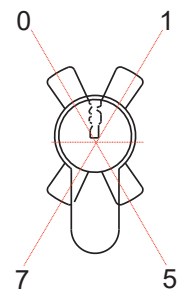

Part #: 2313026 X00 6 Pin
In 5mm steps up to 45mm

Union Single with Thumbturn

Cam position code as shown from outside.

Part #: **2304005 X00 5 Pin**
2304006 X00 6 Pin

Union Half Cylinder

Cam position code as shown from outside.

Part #: **2304015 X00 5 Pin**
2304016 X00 6 Pin

Union Double Cylinder

Cam position code as shown from outside.

Part #: **2304025 X00 5 Pin**
2304026 X00 6 Pin

Scandinavian Oval – Exterior for ASSA/Ruko®

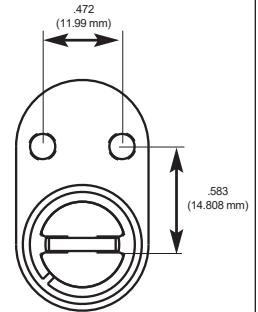
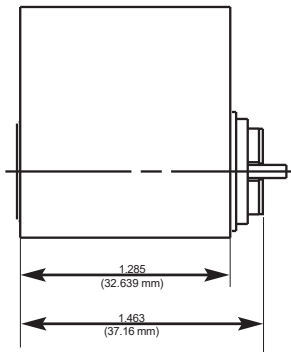
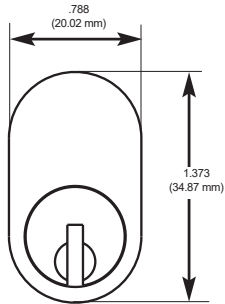

Tailpiece CT-Y76

Part #: 2305016 6 Pin

Scandinavian Oval – Interior for ASSA/Ruko®

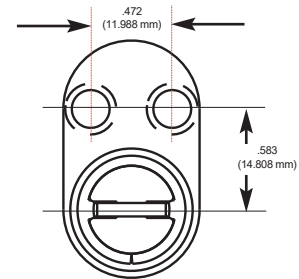
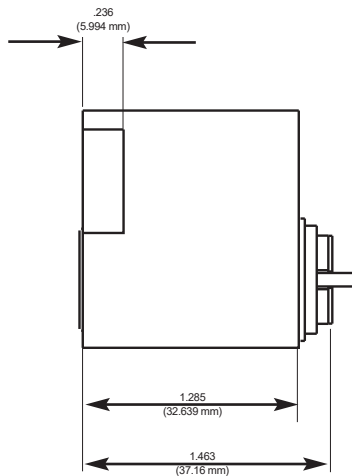
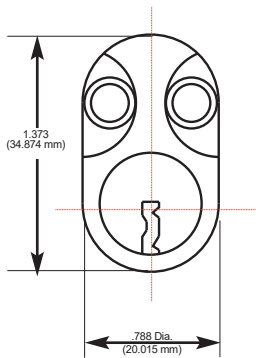

Tailpiece CT-Y76

Part #: 2306016 6 Pin

Scandinavian Padlock – for ASSA/Ruko®

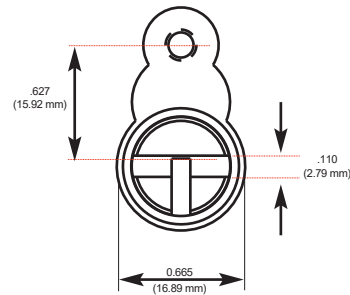
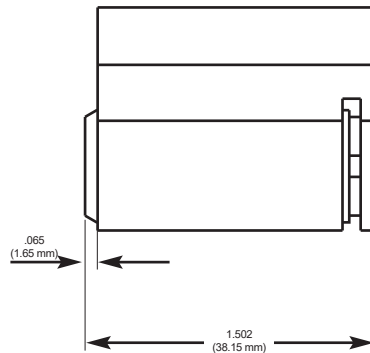
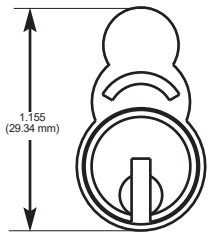

Part #: 2308016X 6 Pin

Scandinavian Round Exterior – for ASSA/Ruko®

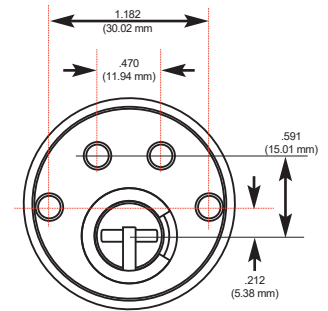
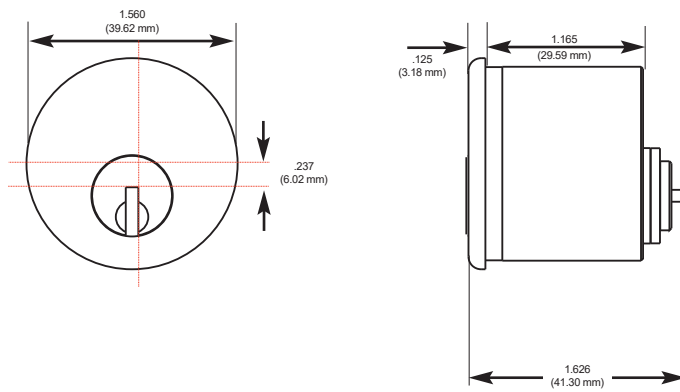

Part #: 2309016 6 Pin

Scandinavian Round Interior – for ASSA/Ruko®

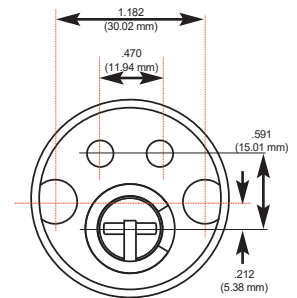
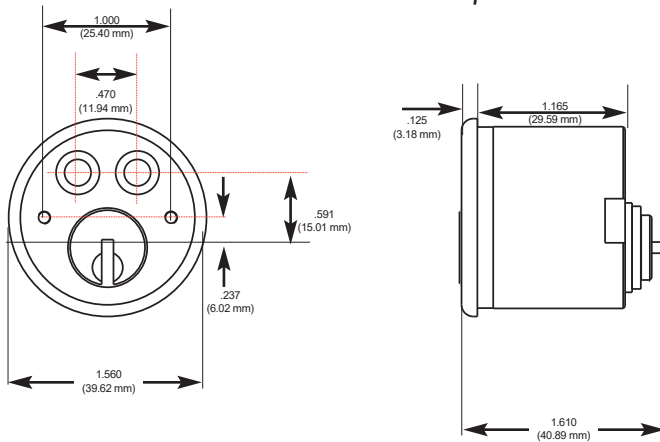

Part #: 2310016 6 Pin

Danish Round – Exterior for Ruko®

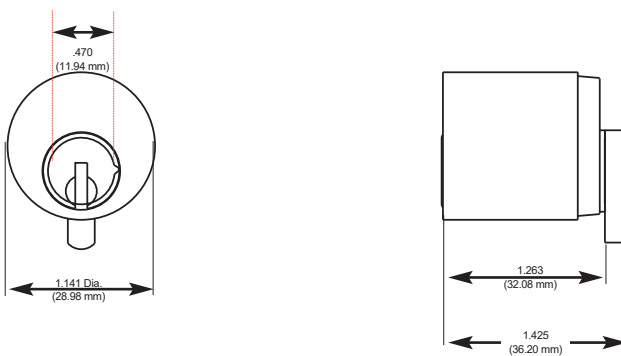

Special pinning required due to chamber height

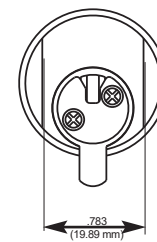

Part #: 2301016 6 Pin

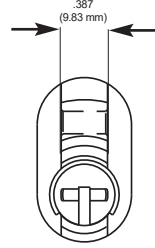
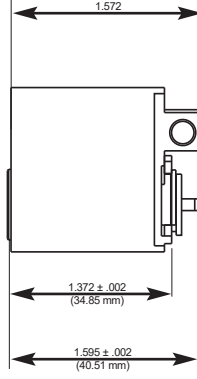
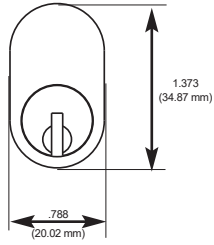
Norwegian Single Cylinder for Trio Ving®

Part #: 23070165 6 Pin

Euroline Modular Profile Kit

Description	Part Number	Price
Euroline Modular Profile Kit - Danish	940243	\$6,363.00
Medeco XT Half Profile Modular Kit	940279	\$4,240.00
Euro Single/Double Thumbturn Kit Mechanical/Electric Available in Medeco XT or M ³ CLIQ	940219	\$6,714.00
Export XT Demo Kit (Programmed to STOCK)	94-0287	\$1,035.00 NET
Upgrade Key Assembly Solo	94-0288	\$263.00 NET
Upgrade Key Assembly Web	94-0289	\$263.00 NET
Medeco XT Cam for Doubles – Not included in kit	CT-Z98	\$5.46

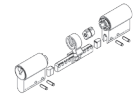
**Euroline Modular Cylinder Assembled**

Description	Part Number	M4	M3	X4
5 Pin Double Cylinder	2323025 X00	\$213.39	\$221.44	
6 Pin Double Cylinder	2323026 X00	\$227.59	\$235.65	
5 Pin Double Thumbturn/Cylinder	23230X5 X00	\$195.50	\$203.56	
6 Pin Double Thumbturn/Cylinder	23230X6 X00	\$205.90	\$213.96	
7 Pin X4 Euro Assembly ext. 0mm Thumbturn	23230X7 500			\$196.50
7 Pin X4 Euro Assembly ext. 5mm Thumbturn	23230X7 511			\$205.00

Euroline Modular Intelligent Key Assembled

Description	Part Number	Price
M ³ CLIQ, Thumbturn/Cylinder, 36/36mm	23230X6 X00 S	\$846.25
M ³ CLIQ Double, 36/36mm	23230E6 X00 S	\$901.59
Medeco XT Single Cylinder Half Euro	232301S 800 G	\$363.53
Medeco XT Single Cylinder Half Euro – ext. 5mm	232301S 801 G	\$367.78
Medeco XT Single Cylinder Half Euro Assembled (True 30mm)	232301ST 800 G	\$363.53
Medeco XT Single Cylinder Euro Thumbturn 30/30mm Assembled	23230XS X00 G	\$405.60
Medeco XT Single Cylinder Euro Thumbturn 35/35mm Assembled	23230XS X11 G	\$414.10
Medeco XT Double Euro Mechanical/eCyl 30/30mm Assembled	23230E5 X00 G	\$479.08
Medeco XT Double Euro Mechanical/eCyl 35/35mm Assembled	23230E5 X11 G	\$487.58
Special Pin Kit for Biaxial/Medeco ³ CLIQ Pinning	.KW5401	\$930.00

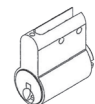
**EuroLine Profile Cylinder Modules**

Description	Part Number	M4	M3	X4
5 Pin Cylinder	2322015 300	\$68.50	\$70.84	
5 Pin Cylinder + 5mm	2322015 301	\$72.75	\$75.09	
6 Pin Cylinder	2322016 300	\$75.10	\$77.44	
6 Pin Cylinder + 5mm	2322016 301	\$79.35		
Medeco X4 Standard 7 Pin Cylinder (35.59mm)	2322017 300 N			\$41.27
Medeco X4 7 Pin + 5mm Cylinder (40.59mm)	2322017 301 N			\$45.52

Note: Pinned Modules include one cut key in the price.

(P) = Pinned (combined)
 (S) = Sub-assembled (uncombined)
 Surcharges for Master Keying, Custom Coining and Custom Stamping apply, see page 196.
 Refer to the XT and CLIQ Intelligent Key sections for format availability and pricing.

Euroline Profile Medeco XT Modules

Description	Part Number	Price
Medeco XT 30mm Single Cylinder Half Euro	232201S 300 G	\$312.52
Medeco XT 35mm Single Cylinder Half Euro	232201S 301 G	\$316.77
Medeco XT 40mm-85mm Single Cylinder Half Euro	232201S 302 G	\$312.52
Medeco XT 30mm Single Cylinder Thumbturn	232202S 300 G	\$312.52
Medeco XT 35mm Single Cylinder Thumbturn	232202S 301 G	\$316.77
Medeco XT 40mm-85mm Single Cylinder Thumbturn	232202S 302 G	\$312.52
Medeco XT 30mm Double Cylinder	232212SX 300 G	\$313.52
Medeco XT 35 mm Double Cylinder	232212SX 301 G	\$317.77
Medeco XT 40mm-85mm Double Cylinder	232222SX 302 G	\$322.02

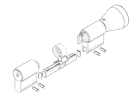
**Euroline Profile Medeco³ CLIQ Modules**

Description	Part Number	Price
M ³ CLIQ, 6 pin Module	2322016 300 S	\$753.51
M ³ CLIQ 6 pin + 5mm	2322016 301 S	\$757.76

EuroLine Profile Thumbturn Modules

Description	Part Number	Price
5 Pin Thumbturn	23220X5 300	\$69.04
6 Pin Thumbturn	23220X6 300	\$74.54
5 Pin X4 Thumbturn Module	23220X5 302	\$69.04

Euroline Profile Medeco XT Thumbturn Modules

Description	Part Number	Price
Euro Thumbturn Module - 30mm	23220XS 300	\$69.92

To order the Euro Thumbturn Module 35mm, you must add the shell ext. CP20071-05 and cart ext. CP-200781-05 to the 30mm Module

Special Cylinders

Description	Part Number	Price
Lockwood Oval retrofit AUS 570 Style	230301S G	\$336.00
KIK AUS 530 Style	201006 G	\$399.29
3-Tailpieces – For Australia Package	94-0283	\$32.10
Medeco XT Ruko Oval	230501S G	\$363.00
Medeco XT AUS 8221 PD Style	20112B1 G	\$399.29

(P) = Pinned (combined)

(S) = Sub-assembled (uncombined)

Surcharges for Master Keying, Custom Coining and Custom Stamping apply, see page 196.
Refer to the XT and CLIQ Intelligent Key sections for format availability and pricing.

Plug Extensions – Outer

*Quantities shown in parentheses below are included in the 94-0219 Euroline modular profile kit listed above. Additional items may be ordered individually.

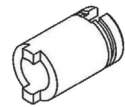

Description	Part Number	Price
10mm Kit Qty (20)	CP-200751-10	\$6.54
15mm Kit Qty (10)	CP-200751-15	\$7.22
20mm Kit Qty (5)	CP-200751-20	\$7.62
25mm Kit Qty (5)	CP-200751-25	\$9.32
30mm	CP-200751-30	\$9.83
40mm	CP-200751-40	\$10.90
45mm	CP-200751-45	\$11.20
50mm	CP-200751-50	\$12.80
55mm	CP-200751-55	\$13.20
60mm	CP-200751-60	\$13.80
65mm	CP-200751-65	\$14.40
70mm	CP-200751-70	\$15.30
75mm	CP-200751-75	\$15.40
80mm	CP-200751-80	\$16.00
85mm	CP-200751-85	\$16.80
90mm	CP-200751-90	\$17.70

**Plug Extensions – Inner**

Description	Part Number	Price
5mm Kit Qty (20)	CP-200761-05	\$4.24
10mm Kit Qty (20)	CP-200761-10	\$4.65
15mm Kit Qty (10)	CP-200761-15	\$5.34
20mm Kit Qty (5)	CP-200761-20	\$5.86
25mm Kit Qty (5)	CP-200761-25	\$7.22
30mm	CP-200761-30	\$7.62
40mm	CP-200761-40	\$8.78
45mm	CP-200761-45	\$10.50
50mm	CP-200761-50	\$10.90
55mm	CP-200761-55	\$11.20
60mm	CP-200761-60	\$12.30
65mm	CP-200761-65	\$12.80
70mm	CP-200761-70	\$17.70
75mm	CP-200761-75	\$17.70
80mm	CP-200761-80	\$18.30
85mm	CP-200761-85	\$19.30
90mm	CP-200761-90	\$19.30

(P) = Pinned (combined)

(S) = Sub-assembled (uncombined)

Surcharges for Master Keying, Custom Coining and Custom Stamping apply, see page 196.
Refer to the XT and CLIQ Intelligent Key sections for format availability and pricing.

*Quantities shown in parentheses below are included in the 94-0219 Euroline modular profile kit listed above. Additional items may be ordered individually.

Plug Extensions - Double EAC/EAC

Description	Part Number	Price
10mm	CP-200851-10	\$16.20
15mm	CP-200851-15	\$16.70
20mm	CP-200851-20	\$17.10
25mm	CP-200851-25	\$18.60
30mm	CP-200851-30	\$19.00
40mm	CP-200851-40	\$20.00
45mm	CP-200851-45	\$20.30
50mm	CP-200851-50	\$20.70
55mm	CP-200851-55	\$21.30
60mm	CP-200851-60	\$22.00
65mm	CP-200851-65	\$22.30
70mm	CP-200851-70	\$22.90
75mm	CP-200851-75	\$23.40
80mm	CP-200851-80	\$23.70
85mm	CP-200851-85	\$24.10
90mm	CP-200851-90	\$24.60



Brass Shell Extensions

Description	Part Number	Price
5mm Kit Qty (20)	CP-200771-05	\$9.05
10mm Kit Qty (20)	CP-200771-10	\$10.50
15mm Kit Qty (10)	CP-200771-15	\$12.10
20mm Kit Qty (5)	CP-200771-20	\$13.60
25mm Kit Qty (5)	CP-200771-25	\$15.10



Connecting Bar

Description	Part Number	Price
5mm Kit Qty (15)	CP-200801-00	\$36.00
10mm Kit Qty (5)	CP-200801-02	\$39.00
20mm Kit Qty (5)	CP-200801-04	\$41.30
30mm Kit Qty (5)	CP-200801-06	\$43.40
40mm Kit Qty (1)	CP-200801-08	\$45.90
50mm Kit Qty (1)	CP-200801-0A	\$48.80
10/10mm Kit Qty (5)	CP-200801-22	\$41.30
10/20mm Kit Qty (5)	CP-200801-24	\$43.40
10/30mm Kit Qty (3)	CP-200801-26	\$45.90
10/40mm Kit Qty (1)	CP-200801-28	\$48.80
10/50mm Kit Qty (1)	CP-200801-2A	\$51.90
20/20mm Kit Qty (3)	CP-200801-44	\$45.90
20/30mm Kit Qty (1)	CP-200801-46	\$48.80
20/40mm Kit Qty (1)	CP-200801-48	\$51.90
20/50mm Kit Qty (1)	CP-200801-4A	\$54.90
30/30mm Kit Qty (1)	CP-200801-66	\$51.90
30/40mm Kit Qty (1)	CP-200801-68	\$54.90
30/50mm Kit Qty (1)	CP-200801-6A	\$57.40
40/40mm Kit Qty (1)	CP-200801-88	\$57.40
40/50mm Kit Qty (1)	CP-200801-8A	\$59.50
50/50mm Kit Qty (1)	CP-200801-AA	\$63.70

(P) = Pinned (combined)

(S) = Sub-assembled (uncombined)

Surcharges for Master Keying, Custom Coining and Custom Stamping apply, see page 196.
Refer to the XT and CLIQ Intelligent Key sections for format availability and pricing.

*Quantities shown in parentheses below are included in the 94-0219 Euroline modular profile kit listed above. Additional items may be ordered individually.



Modular Thumbturn Shaft

Description	Part Number	Price
5 Pin Kit Qty (2)	CP-240771-5P	\$12.90
6 Pin Kit Qty (2)	CP-240771-6P	\$13.20



Modular Service Tools

Description	Part Number	Price
Modular Assembly Block Kit Qty (1)	94-0208	\$1,258.00
Pinning Block Kit Qty (2)	94-0203	\$12.80
Pinning Block Medeco X4	94-0285	\$12.80
KIK Spring Cover Capping Tool Kit Qty (2)	94-0207	\$2.40
Small flat blade screwdriver Kit Qty (1)	94-0221	\$58.10
Removing Punch, 2.3 mm Kit Qty (1)	94-0222	\$176.00
Installing punch, 6.35 mm Kit Qty (1)	94-0223	\$176.00
Allen Wrench, 1.588 mm Kit Qty (1)	CP-280330	\$4.10

Miscellaneous Components

Description	Part Number	Price
Groove Pin Kit Qty (200)	CP-063220	\$0.77
Clutch Piece Assembly Kit Qty (20)	CP-220071	\$10.10
5 Pin Cover Kit Qty (100)	CP-170730-5	\$0.78
6 Pin Cover Kit Qty (100)	CP-170730-6	\$0.78
Double Cam Kit Qty (20)	CT-Z50	\$5.46
Thumbturn Cam Kit Qty (20)	CT-Z51	\$5.46

(P) = Pinned (combined)

(S) = Sub-assembled (uncombined)







Surcharges for Master Keying, Custom Coining and Custom Stamping apply, see page 196.
Refer to the XT and CLIQ Intelligent Key sections for format availability and pricing.

*Quantities shown in parentheses below are included in the 94-0219 Euroline modular profile kit listed above. Additional items may be ordered individually.

Top Pins

Description	Part Number
1 top pin Kit Qty (200)	TP-F10-4T (.180")
2 top pin Kit Qty (200)	TP-F10-5T (.150")
3 top pin Kit Qty (200)	TP-H10-9W (.135")
4 top pin Kit Qty (200)	TP-F10-4W-6T (.120")
5 top pin Kit Qty (200)	TP-F10-3W (.090")
6 top pin Kit qty (200)	TP-F10-2W (.060")

Thumbturn Knobs

Description	Part Number	Price
 Decorative "RD" 4	CP-285901	\$23.70
 Lever "RL" 5	CP-285931	\$35.20
 Round "SR" 0	CP-285961	\$35.20
 Low Profile "LP" 3	CP-285991	\$23.70
 Crescent "CR" 6	CP-286021	\$18.30
 Spade "SP" 7	CP-286051	\$18.30

Finish required.

Thumbturn Assembly - Shaft, Knob, Set Screw - 5 pin

Description	Part Number	Price
Decorative	CP-285921-500	\$71.20
Lever	CP-285951-500	\$108.00
Standard Round	CP-285981-500	\$108.00
Low Profile	CP-286011-500	\$71.20
Crescent	CP-286041-500	\$32.90
Spade	CP-286071-500	\$71.20
Less TT Knob	CP-240761-500	\$31.40

(P) = Pinned (combined)

(S) = Sub-assembled (uncombined)

Surcharges for Master Keying, Custom Coining and Custom Stamping apply, see page 196.
Refer to the XT and CLIQ Intelligent Key sections for format availability and pricing.

Medeco XT Half Cylinder Connecting Bar

*Quantities shown in parentheses below are included in the 94-0279 Euroline half cylinder kit listed above. Additional items may be ordered individually.

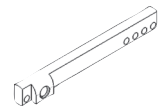

Description	Part Number	Price
40, 45mm Kit Qty (6)	CP-200801-12	\$30.50
50, 55mm Kit Qty (5)	CP-200801-14	\$33.60
60, 65mm Kit Qty (3)	CP-200801-16	\$36.00
70, 75mm Kit Qty (3)	CP-200801-18	\$39.00
80, 85 mm Kit Qty (3)	CP-200801-1A	\$41.30

**Plug Extensions Outer for 94-0279**

Description	Part Number	Price
10mm Kit Qty (20)	CP-200751-10	\$6.54
15mm Kit Qty (15)	CP-200751-15	\$7.22
20mm Kit Qty (5)	CP-200751-20	\$7.62
25mm Kit Qty (5)	CP-200751-25	\$9.32

Brass Shell Extensions for 94-0279

Description	Part Number	Price
5mm Kit Qty (20)	CP-200771-05	\$9.05
10mm Kit Qty (20)	CP-200771-10	\$10.50
15mm Kit Qty (10)	CP-200771-15	\$12.10
20mm Kit Qty (5)	CP-200771-20	\$13.60
25mm Kit Qty (5)	CP-200771-25	\$15.10

Bar Filler (2 per Cylinder) for 94-0279

Description	Part Number	Price
5 Pin, 0mm Kit Qty (20)	CP-160661-50	\$1.51
5 Pin, 5mm Kit Qty (20)	CP-160661-55	\$1.51

Miscellaneous Components for 94-0279







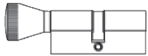

Description	Part Number	Price
Half Shell Backend Kit Qty (20)	CP-200830	\$22.70
Actuator Spring Kit Qty (25)	CP-030860	\$1.36
Indexable Actuator Kit Qty (20)	CP-220090	\$6.14
Security Pin Kit Qty (25)	CP-060106	\$1.51
Groove Pin Kit Qty (65)	CP-063220	\$0.77
Indexable Cam	CT-Z88	\$5.46

(P) = Pinned (combined)

(S) = Sub-assembled (uncombined)

Surcharges for Master Keying, Custom Coining and Custom Stamping apply, see page 196. Refer to the XT and CLIQ Intelligent Key sections for format availability and pricing.

Euro Profile Single Cylinder with Thumbturn

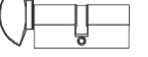
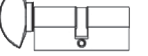

Description	Part Number	M4	M3
 5 Pin, Standard Round "SR" Thumbturn	2313005 X00 (P)	\$195.50	\$203.56
	2313005 X00 (S)	\$179.00	\$187.06
 6 Pin, Standard Round "SR" Thumbturn	2313006 X00 (P)	\$205.90	\$213.96
	2313006 X00 (S)	\$189.40	\$197.46
 5 Pin, Low Profile "LP" Thumbturn	2313035 X00 (P)	\$195.50	\$203.56
	2313035 X00 (S)	\$141.41	\$187.06
 6 Pin, Low Profile "LP" Thumbturn	2313036 X00 (P)	\$205.90	\$213.96
	2313036 X00 (S)	\$189.40	\$197.46
 5 Pin, Removable Decorative "RD" Thumbturn	2313045 X00 (P)	\$195.50	\$203.56
	2313045 X00 (S)	\$179.00	\$187.06
 6 Pin, Removable Decorative "RD" Thumbturn	2313046 X00 (P)	\$205.90	\$213.96
	2313046 X00 (S)	\$189.40	\$197.46
 5 Pin, Removable Lever "RL" Thumbturn	2313055 X00 (P)	\$195.50	\$203.56
	2313055 X00 (S)	\$179.00	\$187.06
 6 Pin, Removable Lever "RL" Thumbturn	2313056 X00 (P)	\$205.90	\$213.96
	2313056 X00 (S)	\$189.40	\$197.46
 5 Pin, Euro Crescent "CR" Thumbturn	2313065 X00 (P)	\$195.50	\$203.56
	2313065 X00 (S)	\$179.00	\$187.06
 6 Pin, Euro Crescent "CR" Thumbturn	2313066 X00 (P)	\$205.90	\$213.96
	2313066 X00 (S)	\$189.40	\$197.46

(P) = Pinned (combined)

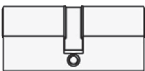
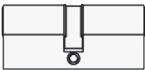
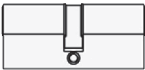
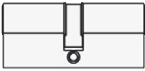
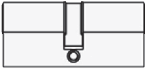
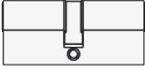
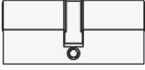

(S) = Sub-assembled (uncombined)

Surcharges for Master Keying, Custom Coining and Custom Stamping apply, see page 196.
Refer to the XT and CLIQ Intelligent Key sections for format availability and pricing.

Euro Profile Double Cylinder

Description	Part Number	M4	M3
 5 Pin, No Extension	2313025 X00 (P)	\$199.45	\$207.50
	2313025 X00 (S)	\$166.45	\$174.50
 5 Pin Extended, 5 mm Ext. Side (0mm/5mm)	2313025 X01 (P)	\$203.70	\$211.75
	2313025 X01 (S)	\$170.70	\$178.75
 5 Pin Extended, 10 mm Ext. Side (0mm/10mm)	2313025 X02 (P)	\$207.95	\$216.00
	2313025 X02 (S)	\$174.95	\$183.00
 5 Pin Extended, (5mm/5mm)	2313025 X11 (P)	\$207.95	\$216.00
	2313025 X11 (S)	\$174.95	\$183.00
 5 Pin Extended, (5mm/10mm)	2313025 X12 (P)	\$212.20	\$220.25
	2313025 X12 (S)	\$179.20	\$187.25
 6 Pin, No Extension	2313026 X00 (P)	\$213.39	\$221.44
	2313026 X00 (S)	\$180.39	\$188.44
 6 Pin Extended, 5mm Ext. Side (0 mm/5 mm)	2313026 X01 (P)	\$217.64	\$225.69
	2313026 X01 (S)	\$184.64	\$192.69
 6 Pin Extended, 10mm Ext. Side (0 mm/10 mm)	2313026 X02 (P)	\$221.89	\$229.94
	2313026 X02 (S)	\$188.89	\$196.94
 6 Pin Extended, (5mm/10mm)	2313026 X12 (P)	\$226.14	\$234.19
	2313026 X12 (S)	\$193.14	\$201.19

Euro Profile Half Cylinder

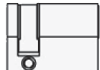
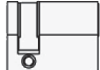
Description	Part Number	M4	M3
 5 Pin with 12 Position Indexable Cam	2313015 800 (P)	\$167.37	\$175.43
	2313015 800 (S)	\$150.87	\$158.93
 5 Pin, Extended 5 mm with 12 Position Indexable Cam	2313015 801 (P)	\$171.62	\$179.68
	2313015 801 (S)	\$155.12	\$163.18
 6 Pin with 12 Position Indexable Cam	2313016 800 (P)	\$169.45	\$177.50
	2313016 800 (S)	\$152.95	\$161.00
 6 Pin, Extended 5 mm with 12 Position Indexable Cam	2313016 801 (P)	\$173.70	\$181.75
	2313016 801 (S)	\$157.20	\$165.25

(P) = Pinned (combined)
 (S) = Sub-assembled (uncombined)
 Surcharges for Master Keying, Custom Coining and Custom Stamping apply, see page 196.
 Refer to the XT and CLIQ Intelligent Key sections for format availability and pricing.

Other International Cylinders

Description	Part Number	M4	M3
Danish Round Mortise Cylinder	2301016 (P)	\$156.50	\$162.80
	2301016 (S)	\$140.00	\$146.30
Australian Oval - Less Cams and Pins	2303016A (S)	\$179.00	\$187.06
5 Pin British Oval Single Cylinder with Thumbturn	2304005 (P)	\$219.50	\$228.63
	2304005 (S)	\$203.00	\$212.13
6 Pin British Oval Single Cylinder with Thumbturn	2304006 (P)	\$219.50	\$228.63
	2304006 (S)	\$203.00	\$212.13
5 Pin British Oval Half Cylinder	2304015 (P)	\$163.87	\$173.00
	2304015 (S)	\$147.37	\$156.50
6 Pin British Oval Half Cylinder	2304016 (P)	\$163.87	\$173.00
	2304016 (S)	\$147.37	\$156.50
5 Pin British Oval Double Cylinder	2304025 (P)	\$224.94	\$234.07
	2304025 (S)	\$191.94	\$201.07
6 Pin British Oval Double Cylinder	2304026 (P)	\$224.94	\$234.07
	2304026 (S)	\$191.94	\$201.07
Scandinavian Oval Exterior Cylinder	2305016 (P)	\$162.50	\$169.07
	2305016 (S)	\$146.00	\$152.57
Scandinavian Oval Interior Cylinder	2306016 (P)	\$162.50	\$169.07
	2306016 (S)	\$146.00	\$152.57
Norwegian Oval Shape Cylinder	23070165 (P)	\$182.50	\$189.97
	23070165 (S)	\$166.00	\$173.47
Scandinavian Snowman Cylinder	23080166 (P)	\$186.50	\$194.15
	23080166 (S)	\$170.00	\$177.65
Scandinavian Round Exterior Cylinder	2309016 (P)	\$239.50	\$249.53
	2309016 (S)	\$223.00	\$233.03
Scandinavian Round Interior Cylinder	2310016 (P)	\$239.50	\$249.53
	2310016 (S)	\$223.00	\$233.03
Italian Cylinder Inner Gate Lock, 3 Pin	2314003 (P)	\$115.20	\$119.64
	2314003 (S)	\$98.70	\$103.14
Italian Cylinder Exterior Gate Lock, 5 Pin	2315005 (P)	\$130.50	\$135.63
	2315005 (S)	\$114.00	\$119.13
Italian Roller Shutter 4 Pin	2316004 (P)	\$130.50	\$135.63
	2316004 (S)	\$114.00	\$119.13
Danish Cam Lock (for Ruko®) w/ 90° Stop	2320016 (P)	\$156.50	\$162.80
	2320016 (S)	\$140.00	\$146.30

(P) = Pinned (combined)

(S) = Sub-assembled (uncombined)

Surcharges for Master Keying, Custom Coining and Custom Stamping apply, see page 196.
Refer to the XT and CLIQ Intelligent Key sections for format availability and pricing.

Profile Components

Description	Part Number	Price
5 Pin Plug For Half Cylinder	12286	\$71.10
5 Pin Double Cylinder Profile Plug	12286	\$71.10
6 Pin Plug For Half Cylinder	12288	\$71.10
6 Pin Double Cylinder Profile Plug	12288	\$71.10
5 Pin Double Cylinder Profile Shell	13327	\$100.00
6 Pin Double Cylinder Profile Shell	13346	\$100.00
6 Pin Shell For Half Cylinder	13375	\$100.00
Thumbturn Set Screw	CP-011013-020	\$0.37
Profile Cylinder Set Screw, #8-32 x 1/4"	CP-011013-040	\$0.50
Set Screw for "CR" Thumbturn	CP-012409-030	\$0.76
Thumbturn Set Screw	CP-012411-030	\$0.96
Set Screw For Removable Thumbturn	CP-012411-040	\$0.96
Thumbturn Retaining Clip	CP-020031	\$7.22
Cartridge Retainer	CP-020240	\$0.31
Plug Retaining Clip - Old Style, C Clip	CP-021400	\$6.81
Plug Retaining Clip - Continuous Ring	CP-021490	\$2.06
Tumbler Spring	CP-030001	\$0.11
Single Cylinder Profile Pilot Spring	CP-030024	\$0.80
Single Cylinder Profile Thumbturn Actuator Spring	CP-030025	\$0.30
Actuator Spring For Half Cylinder	CP-030860	\$1.36
Snap Ring	CP-031030	\$0.84
Single Cylinder Profile Actuator	CP-100111	\$13.60
Double Cylinder Profile EAC/EAC Push Rod	CP-100761	Consult Factory
Double Cylinder Profile Clutch	CP-220071	\$10.10
5 and 6 Pin Actuator For Half Cylinder	CP-220090	\$6.14
Clutch Assembly, Emergency	CP-220120	\$36.80
Double Cylinder Profile EAC/EAC Clutch	CP-220201	\$97.40
Double Cylinder Profile Gear Cam	CP-230081	\$12.10
Thumbturn Cylinder Profile Gear Cam	CP-230091	\$12.10
Single Cylinder Profile Thumbturn Actuator Pilot	CP-280261	\$18.30
Standard Round "SR" Thumbturn Assembly 5 Pin	CP-285981-500	\$108.00
Low Profile "LP" Thumbturn Assembly 5 Pin	CP-286011-500	\$71.20
Lever "RL" Thumbturn Assembly 5 Pin	CP-285951-500	\$108.00
Crescent "CR" Thumbturn Assembly 5 Pin	CP-286041-500	\$32.90
Decorative "RD" Thumbturn Assembly 5 Pin	CP-285921-500	\$71.20
Decorative "RD" Thumbturn Only	CP-285901	\$23.70
Lever "RL" Thumbturn Only	CP-285931	\$35.20
Low Profile "SR" Thumbturn Only	CP-285961	\$35.20
Low Profile "LP" Thumbturn Only	CP-285991	\$23.70
Oval Int./Ext. Cylinder tailpiece	CT-Y76	\$5.46
Cam, British Oval (Half/Double)	CT-Z26	\$5.46
Cam, British Oval (Thumbturn)	CT-Z29	\$5.46
Double Cylinder Profile Cam	CT-Z50	\$5.46
Thumbturn Cylinder Profile Cam, Non Indexing	CT-Z51	\$5.46
Indexing Cam For Half Cylinders	CT-Z88	\$5.46
Cam, Medeco XT Double Profile Cyl	CT-Z98	\$5.46
Double Cylinder Profile EAC/EAC Cam	CT-ZA2	\$5.46

(P) = Pinned (combined)

(S) = Sub-assembled (uncombined)

Surcharges for Master Keying, Custom Coining and Custom Stamping apply, see page 196.

Refer to the XT and CLIQ Intelligent Key sections for format availability and pricing.

Keying Charges

Description	Part Number	Price
Less Key Credit		\$1.00
MK surcharge to pinned door hardware cylinders and IC cylinders except SFIC cylinders.		\$27.00
No MK surcharge is applied to the pinned cylinder price for Medeco X4 SFIC cylinders.		
MK surcharge to pinned cam lock type product (less keys)		\$6.00
Key Stamping (Standard Key Code Stamping at No Charge)		\$4.50
Lock Stamping (No charge for SFIC)		\$11.50
Surcharge - Medeco X4 Custom Coined Cut keys require a minimum of 100 keys and must be specified on the order. Non-custom coined cut keys are standard from the factory. The surcharge is added to the cut key price.		\$4.25
Surcharge - High Security Custom Coined Cut keys require a minimum of 100 keys and must be specified on the order. Non-custom coined cut keys are standard from the factory. The surcharge is added to the cut key price.		\$4.25
Sub-assembled deduct applied for door products		-\$16.50
Sub-assembled deduct applied for Medeco X4 SFIC		-\$16.50
Sub-assembled deduct applied for 60 Series products		-\$29.00
Cylinder recombining: non-master keyed cylinders (less keys)	RE-KEY	\$72.00
Cylinder recombining: master keyed cylinders (less keys)	RE-KEY-MK	\$86.20
Decode Key Service	DE-CODE-KEY	\$41.80
Decode Lock Service (not available for padlocks)	DE-CODE-LOK	\$42.60
Sharpen Cutter for Medeco ³ and Medeco X4 (exchange program; old cutter must be returned upon receipt with RGA)	95-100400-SHARP	\$275.00

Cut Keys

Description	Part Number	Price
Medeco 4 Large Bow Cut Keys	KYC 4LX600 XX XX XXX	\$25.71
Medeco 4 Small Bow Cut Keys	KYC 4SX600 XX XX XXX	\$25.71
Medeco 4 Custom Coined Cut Keys - Large Bow*	KYC 4LX600 XX 99 XXX	\$29.96
Medeco 4 Custom Coined Cut Keys - Small Bow*	KYC 4SX600 XX 99 XXX	\$29.06
Original, Biaxial and M3 Custom Coined Cut Keys*	KYC XX5600 XX 99	\$28.85
Original, Biaxial and M3 Cut Keys	KYC XX6600 XX XX	\$24.60
Medeco X4 Custom Coined Cut Keys*	KYC XX6900 XXX 99	\$26.65
Medeco X4 Cut Keys	KYC XX6900 XXX XX	\$22.40
Medeco B Cut Keys, A5 Bow	KYC A50000 AXX 00	\$16.51
Medeco B Cut Keys, A6 Bow	KYC A60000 AXX 00	\$19.19

* Minimum order 100 Custom Coined Cut Keys.

Contact Customer Service for specific part number.

Coining Dies

Description	Part Number	Price
Standard Coining Die-All keyway technologies	CN-DIES	\$738.00 (NET)
Laser Die	ST-LASER	\$167.00 (NET)

Key Code Cards

Description	Part Number	Price
Authorization Card for 6 Pin Key (Patriot, Liberty, Freedom, Gotham)	CARD 1 X XX	\$15.90
Authorization Card for 5 Pin Key (Patriot, Liberty, Freedom, Gotham)	CARD 2 X XX	\$15.90
Authorization Card for 5 Pin (60Series) Key (Patriot, Liberty, Freedom, Gotham)	CARD 6 X XX	\$15.90
Authorization Card with (2) 6 Pin Keys (Medeco KM Silver)	CARD KS XX 8E	\$49.20
Authorization Card with (2) 5 Pin Keys (Patriot, Liberty, GLD, DND, Freedom, Gotham)	CARD XX 56 XX	\$49.20
Authorization Card with (2) 6 Pin Keys (Patriot, Liberty, GLD, DND, Freedom, Gotham)	CARD XX 66 XX	\$49.20
Printed Key Code Tag For Dealer Keyways	CP-286131	\$1.36

Code Books, Vouchers, & Paper

Description	Part Number	Price
Medeco ³ , Medeco 4, Medeco ³ & Biaxial Code Book	CB-CODE-BIA	\$55.60 (NET)
Medeco Original Code Book	CB-CODE-BOK	\$55.60 (NET)
USB Card Reader for Online Key Control and Key Management Portals	94-0309	\$89.20 (NET)

Sales Tools

Description	Part Number	Price
Smart SFIC Solutions Demo Kit (Includes Arrow, Medeco X4, and Medeco XT SFIC Cylinders)	94-0261	\$1,737.00
Medeco X4 Presentation Kit includes: Std. Rim & Mortise Cylinders, SFIC Mortise, Key-In-Knob Cylinder, all LFIC cylinders in plastic case	94-0269	\$371.00 (NET)
6 Pin Medeco ³ BiLevel Cut-Away Cylinder	100400 CUT J	\$135.91 (NET)
6 Pin Medeco 4 Cut-Away Cylinder	100400 CUT H	\$228.50 (NET)
Cut-Away 5 Pin Profile Cylinder	23130 CUT	\$221.00 (NET)
Cut-Away Cam Lock Assembly – Biaxial only	600300 CUT W 219	\$112.44 (NET)
Plastic Display Sleeve for Maxum (lock not included)	90-0028	\$24.00 (NET)
XT Install/Demo Key (works cylinders not yet programmed to a system) – Industrial Style	EA-100111	\$320.00
XT Install/Demo Control Key (works IC cylinders not yet programmed to a system) – Industrial Style	EA-100110	\$320.00
XT Install/Demo Key – Slim Line (works cylinders not yet programmed to a system)	EA-100173	\$297.00
XT Install/Demo Control Key – Slim Line (works IC Cylinders not yet programmed to a system)	EA-100174	\$297.00

Keyblanks for Cam Lock Style - Original, Biaxial, Medeco³

Description	Part Number	Price
5 Pin Commercial Original Keyblank for 60 Series, Thick Head (Non Custom Coined)	KYB 115400 XX 00	\$11.90
5 Pin Commercial Original Keyblank for 60 Series, Thin Head (Non Custom Coined)	KYB 105400 XX 00	\$11.90
5 Pin Commercial Medeco Biaxial Keyblank for 60 Series, Thick Head (Non Custom Coined)	KYB 115400 S6 43	\$11.90
5 Pin Keyblank for 60 Series (Custom Coined)	KYB XX5400 XX 99	\$11.90

Note: All custom coined keyblanks require a minimum order of 100.

Keyblanks for Door Hardware - Original, Biaxial, Medeco³, Medeco 4

Description	Part Number	Price
5 or 6 Pin Keyblank for Medeco 4 (Large Bow, Custom Coined)	KYB 4LX600 XX 99 XXX	\$12.71
5 or 6 Pin Keyblank for Medeco 4 (Small Bow, Custom Coined)	KYB 4SX600 XX 99 XXX	\$12.71
5 or 6 Pin Keyblank – All Bow Sizes (Non Custom Coined)	KYB 10X600 XX XX	\$11.90
5 or 6 Pin Keyblank for Medeco ³ (Small Bow, Custom Coined)	KYB 34X600 XX 99	\$11.60
5 or 6 Pin Keyblank for Medeco ³ (Large Bow, Custom Coined)	KYB 33X600 XX 99	\$11.60
5 or 6 Pin Keyblank for Medeco Biaxial Rectangular (Small Bow, Custom Coined)	KYB 12X600 XX 99	\$11.60
5 or 6 Pin Keyblank for Medeco Biaxial, Square (Large Bow, Custom Coined)	KYB 17X600 XX 99	\$11.60
5 or 6 Pin Keyblank for Thumbturn (blade only)	KYB 10X605 XX	\$15.00
5 or 6 Pin Keyblank for Thumbturn (blade only) for M4	KYB 10X605 XX XXX	\$15.00

Note: All custom coined keyblanks require a minimum order of 100.

Keyblanks for Door Hardware - Medeco KM, Medeco X4 & Medeco B

Description	Part Number	Price
6 or 7 Pin Keyblank for Medeco KM (Small Bow, Custom Coined)	KYB 32X600 XX 99	\$11.10
6 or 7 Pin Keyblank for Medeco KM (Large Bow, Custom Coined)	KYB 38X600 XX 99	\$11.10
6 or 7 Pin Keyblank for Medeco X4 (Small Bow, Custom Coined)	KYB 32X900 XXX 99	\$11.10
6 or 7 Pin Keyblank for Medeco X4 (Large Bow, Custom Coined)	KYB 38X900 XXX 99	\$11.10
6 or 7 Pin Keyblank – All Bow Sizes (Non-Coined)	KYB 3XXX00 XX XX	\$11.90
6 or 7 Pin Keyblank for Medeco B, Alphabet & T Keyways	KYB A50000-AXX00	\$3.81
6 or 7 Pin Keyblank for Medeco B, W Family Keyways	KYB A60000-AXX00	\$6.49

Note: All custom coined keyblanks require a minimum order of 100.

Note: If you are ordering control keyblanks for Schlage or ASSA ABLOY ACCENTRA (formerly Yale), they must be stamped with the dealer's coining die number for identification purposes.

Medeco 4/Medeco³/Biaxial Door Hardware Pin Kits

Description	Part Number	Price
Medeco 4 Side Pin Kit. 30 each of side pins 0 through 5	KH-5701	\$623.00
Medeco 4 Distributor Side Pin Kit. 100 each of side pins 0 through 3	KH-5702	\$1,117.00
Medeco Biaxial 10 through 50 Series broached and milled pin combination (Door Hardware), Large Metal Box, 30 Each of Bottom, Master, Top Pins	.KW5005	\$1,233.00
Medeco Biaxial 10 Through 50 Series (Door Hardware), Large Metal Box, 100 Each of Bottom, Master, & Top Pins	.KW5006	\$2,693.00
Medeco Biaxial 10 Through 50 Series (Door Hardware), Small Metal Box, 10 Each of Bottom, Master & Top Pins	.KW5007	\$926.00
Medeco Biaxial Pin Kit with 30 ea. 53 Series (broached) Pins for Biaxial Cylinders with Sidebars Manufactured Prior to 2/2003	.KW5011	\$1,233.00
Medeco Biaxial Pin Kit with 100 ea. 53 Series (broached) Pins for Biaxial Cylinders with Sidebars Manufactured Prior to 2/2003	.KW5012	\$2,693.00
Medeco Biaxial Pin Kit for 32 Series LFIC Cylinders. 4, 5, and 6 Pins Only with 50 each 53 Series Pins	.KW5010	\$613.00
Medeco Biaxial/Medeco ³ Pin Kit for Medeco ³ CLIQ	.KW5401	\$930.00

Medeco³/Biaxial Cam and Switch Lock Pin Kits

Description	Part Number	Price
Medeco Biaxial 60 Series (Cam & Switch locks), 100 Each of Bottom Pins (Top Pins Not Used)	.K-9001	\$1,698.00
Medeco Biaxial 60 Series (Cam & Switch Locks), Small Metal Box, 10 Each of Bottom Pins (Top Pins Not Used)	.KW9003	\$543.00

Medeco³ BiLevel Pin Kits

Description	Part Number	Price
BiLevel Pin Kit for M3 and M4 BiLevel (100 ea. BiLevel Top & Bottom Pins)	.KJ1501	\$1,080.00

Medeco KM and X4 Pin Kits (Available in USA and Canada)

Description	Part Number	Price
Medeco KM and X4 Pin Kit for SFIC; Large Wood Kit, 100 Each Bottom and Master/Top Pins. Springs, Caps, Spring Covers, Set Screws, Pinning Fixture, Capping Punch, Pin Ejector and Key Gauge Included.	.K-4001	\$1,437.00
Medeco KM and X4 mini Pin Kit for SFIC; Small Metal Pin Kit, 30 Each Bottom Pins, 60 Each Master/Top Pins. Springs, Caps, and Spring Covers included.	.K-4002	\$351.00
Medeco X4 Pin Kit for Conventional Cylinders (.511 plug), not SFIC; 100 Each Bottom and Master/Top Pins. Springs, Spring Covers, Set Screws, and Key Gauge included.	.K-4006	\$1,044.00

Medeco KM and X4 Pin Kits (Available in Canada Only)

Description	Part Number	Price
Medeco KM Pin Kit; (Classic Only) Large Wooden Pin Kit, 100 Each Bottom, Master & Top Pins. Spring, Caps, Spring Covers, Set Screws, Pinning Fixture, Capping Punch, Pin Ejector & Key Gauge also included	K-4003	\$1,482.00
Medeco KM Mini Pin Kit; (Classic Only) Small Metal Pin Kit, 30 Bottom Pins, 60 Each of Master & Top Pins, Springs, Caps, Spring Covers, & Set Screws also included.	K-4004	\$360.00

Medeco Original Door Hardware Pin Kits

Description	Part Number	Price
Medeco Original Door Hardware Pins, Full Step, Metal Box, 30 Ea. of Bottom & Top Pins	.K-1001	\$560.00
Medeco Original Door Hardware Pins, Full Step, Metal Box, 100 Ea. of Bottom & Top Pins	.K-1002	\$1,633.00
Medeco Original Door Hardware Pins, Full Step, Plastic Box, 100 Ea. of Master Pins #1 - #5 Only	.K-1003	\$121.00
Medeco Original Door Hardware Pins, Small Metal Box, 10 Ea. of Bottom, Master, & Top Pins	.K-1005	\$557.00
Medeco Original Door Hardware Pins, 1/2 Step, Large Metal Box, 100 Ea. of Bottom, Master & Top Pins	.K-1006	\$2,702.00

Medeco Original Cam & Switch Lock Pin Kits

Description	Part Number	Price
Medeco Original Cam & Switch Type Pins, Full Step, Plastic Box, 100 Ea. of Bottom Pins (Top Pins Not Used)	.K-6001	\$1,354.00
Medeco Original Cam & Switch Style Pins, Full Step, Plastic Box, 100 Ea. of Master Pins (Top Pins Not Used)	.K-6002	\$1,581.00

Pins (Sold in packs)

Description	Part Number	Package Size	Price
M4/M3 Biaxial Bottom Pins (.025" increment)	TP-F50-XX	100	\$149.00
M4/M3 Biaxial Master Wafers (.025 increment)	TP-F50-XW	100	\$56.00
Medeco 4 Side Combination pin, 1-3	TP-F57-X	10	\$24.40
Medeco 4 Side Master Pin, 4-5	TP-F57-X	10	\$24.40
Medeco 4 Side Lift Pin, 0	TP-F57-0	10	\$24.40
M4/M3 Biaxial Broached Bottom Pins (.025" increment)	TP-F53-XX	100	\$149.00
Medeco Original Bottom Pins (.030" increment)	TP-F10-XX	100	\$149.00
Medeco Original Master Wafers (.030" increment)	TP-F10-XW	100	\$56.00
1T - Standard Stainless Steel Top Pin	TP-F10-1T	100	\$58.00
2T - Brass Mushroom Top Pin	TP-F10-2T	100	\$95.00
3T - Stainless Steel Barrel Top Pin	TP-F10-3T	100	\$58.00
4T - Stainless Steel Barrel Top Pin	TP-F10-4T	100	\$58.00
5T - Standard Stainless Steel Top Pin	TP-F10-5T	100	\$58.00
6T - Brass Standard Top Pin			
Note: 4W is the master wafer and 6T is the top pin.	TP-F10-4W-6T	100	\$56.00
Original 60 Series Pins	TP-F60-XX	100	\$149.00
Medeco ³ /Biaxial 60 Series Pins (.025 increment)	TP-F90-XX	100	\$149.00
Medeco KM and X4 Bottom Pins, #0B-9B Note: Medeco X4 SFIC only	TP-K40-XX-BH	100	\$15.60
Medeco KM and X4 Top Pins #02-19T	TP-K40-XX-TH	100	\$14.00
Medeco X4 Bottom Pins for Conventional Cylinders #00-09	TP-K43-XX-BH	100	\$22.60
KM Offset Top Pin	TP-K42-Z9	100	\$149.00
Medeco BiLevel Top Pins	TP-F15-XT	100	\$57.00
Medeco BiLevel Bottom Pins (.025 increment)	TP-F15-XB	100	\$72.00

Caps (Sold in packs)

Description	Part Number	Pack Sizes	Price
Medeco X4 I/C Pin Spring Caps (Stamped) (for rekeying)	CP-170430	100	\$7.34
Medeco X4 I/C Pin Spring Caps (Machined) (for new cylinder)	CP-170440	100	\$7.34
Spring Covers for Medeco LFIC, Corbin (7 pin) LFIC, and Yale LFIC (6 and 7 pin), Brass, 1.010" Length	CP-170011	100	\$69.00
5 Pin Spring Covers for Medeco 32 Series I/C, Cam and Switch Lock Plugs, Brass, .840" Length	CP-170021	100	\$48.00
3 Pin Spring Covers for Cam and Switch Lock Plugs, Brass, .500" Length	CP-170031	100	\$69.00
4 Pin Spring Covers for Cam and Switch Lock Plugs, Brass, .670" Length	CP-170041	100	\$69.00
6 Pin Spring Covers for Medeco and Medeco X4 20 Series Key-in-Knob Cyls (Old Style), Schlage LFIC, Stainless Steel, .980" Length	CP-170051	100	\$69.00
5 Pin Spring Covers for Medeco 20 Series Key-in-Knob Cyls (Old Style), Stainless Steel, .810" Length	CP-170061	100	\$69.00
6 Pin Spring Covers for Medeco ³ 32*0202 Removable Cylinder for 50 Series Brass Body Padlocks, Brass, 1.010" Length (Notch in cover for steel ball bearing retainer)	CP-170271	100	\$69.00
6 Pin Spring Covers for Medeco & Medeco X4 20 Series Key-in-Knob Cylinders & Medeco X4	CP-170730-6	100	\$78.00
5 Pin Spring Covers for Medeco 20 Series Key-in-Knob Cylinders	CP-170730-5	100	\$78.00
6 Pin Spring Cover for Corbin and Sargent LFIC	CP-170481	100	\$69.00

Springs (Sold in packs)

Description	Part Number	Pack Sizes	Price
Tumbler Springs, 10 Series Door Hardware	CP-030001	100	\$11.70
Tumbler Springs, 60 Series Cam & Switch Locks	CP-030017	100	\$11.70
Sidebar Springs	CP-030018	100	\$11.70
Tumbler Springs, 32 Series (stainless steel)	CP-030042	100	\$12.00
Medeco ³ Slider Springs	CP-030910	100	\$12.00
Medeco 4 Side Pin Springs	CP-031560	100	\$12.00

Medeco X4 Springs (Sold in packs)

Description	Part Number	Pack Sizes	Price
Medeco X4 Springs	CP-030590	300	\$23.70
Medeco X4 Conventional Locking Pin Spring	CP-031170	100	\$43.00
Medeco X4 SFIC Locking Pin Spring	CP-031480	100	\$43.00

Screws (Sold in packs)

Description	Part Number	Pack Sizes	Price
#2-56 x 3/16" Flat Head Cam Screw for 10-0100 Cylinder	CP-010203-030	100	\$30.00
#2-56 x 1/4" Flat Head Screw for 32 Series I/C Housing	CP-010103-040	100	\$80.00
#2-56 x 5/16" Flat Head Phillips, Nylon Patch Cam Screw for Mortise Cylinders	CP-010203-050	100	\$30.00
#2-56 x 1/4" Pan Head Screw for 20-0901 and Other Lazy Motion Retainers	CP-010503-040	100	\$44.00
#8-32 x 1/8" Allen Set Screw Cone for Pin Chambers (10 Series Rim & Mortise)	CP-011013-020	100	\$37.00
#8-32 x 1/4" Allen Set Screw Cone for Pin Chambers (23 Series Profile Cylinders)	CP-011013-040	100	\$50.00
Set Screw for non-I/C Medeco X4 Rim & Mortise Cylinders	CP-011011-020	100	\$31.00

Misc. Components

Description	Part Number	Price
Medeco 4 Sidebar - 5 pin	CP-0845A0	\$12.10
Medeco 4 Sidebar - 6 pin	CP-0846A0	\$12.10
5 Pin Sidebar Assembly .123" for Door Hardware Cylinders	CP-084571	\$9.83
6 Pin Sidebar Assembly .123" for Door Hardware Cylinders	CP-084671	\$9.83
Medeco ³ Slider and Spring Package	94-0174-XX	\$16.20
Medeco X4 Conventional Slider and Spring Package	94-0255-XX	\$16.20
Medeco X4 SFIC Slider and Spring Package	94-0256-XX	\$16.20
Medeco X4 Conventional Locking Pin	CP-064231	\$5.58
Medeco X4 SFIC Locking Pin	CP-064701	\$5.58

Cam & Tailpiece Kit

Description	Part Number	Price
10 and 20 Series Tailpieces (Plastic Box, Assorted Cams and Tailpieces for 10 & 20 Series) Includes: CT-Y02, CT-Y08, CT-Y24, CTY32, CT-Y49, CT-Y52, CT-Y53, CT-Z00, CT-Z01, CT-Z02, CT-Z04, CT-Z06, CT-Z07, CT-Z08, CTZ09, CT-Z16	.K-1099	\$748.00







Empty Pin Boxes - Any Technology

Description	Part Number	Price
Large Latched Metal Pin Box (Empty) 60 Assorted Size Compartments. Overall Measurements 1.875" Deep, 13.56" wide, 9.75 front to back.	CP-282460	\$299.00
Small Latched Metal Pin Box (Empty) 67 Assorted Size Compartments, Overall .688" Deep, 8.876" Wide, 5.875" Front to Back	CP-282470	\$180.00

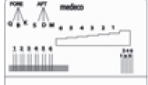
Pin Hole Covers for 60 Series (sold in packs of 100)

Description	Part Number	Pack Sizes	Price
5 Pin, Pin Hole Covers-Brass	CP-170021	100	\$48.00
4 Pin, Pin Hole Covers-Brass	CP-170041	100	\$69.00
3 Pin, Pin Hole Covers-Brass	CP-170031	100	\$69.00

Tools & Fixtures

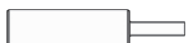
Description	Part Number	Price
 Spanner Wrench for Rim Cylinder Tailpiece Nut	90-0001	\$4.39
 Medeco 4/Universal Key Gauge/Decoder	94-0323	\$43.40
Installation Tool for Key-in-Knob capping	94-0207	\$2.40 (NET)
 5 Pin Staking Tool, 60 Series Cam/ Switch Locks and 32 Series LFIC	CP-282430	\$166.00
 Holding Block Assembly (use with 10, 20, 32, & 60 Series Cylinders)	CP-282451	\$1,196.00
 Switch Lock Tool (Facilitates spring insertion on momentary function)	T-7155	\$36.80
 Medeco X4 I/C Pinning Block (6 or 7 Pin)	CP-282500	\$250.00
 Medeco X4 I/C Pin Ejector	CP-282530	\$61.10
 Medeco X4 I/C Hand Capping Punch	CP-282540	\$39.60
Medeco X4 Key Decoder	CP-286350	\$45.10
Sargent LFIC (X4 and M3 cores primarily for pre 2008 housings) Shear tool	CP-286851	\$320.00 (NET)
Corbin (For M3 cores) LFIC Shear tool	CP-287371	\$320.00 (NET)

Lubricants

Description	Part Number	Price
Fluid Film Spray (2.25oz.)	PX-KYLUBE-02	\$23.90
Fluid Film Spray (11.75oz.)	PX-KYLUBE-11	\$37.90

Key Machines

Description	Part Number	Price
Key Machine, Original, 115V	95-M11000	\$16,782.00
Key Machine, Biaxial, 115V	95-M23000	\$16,782.00
Key Machine, Universal, 115V	95-M34000	\$17,861.00
Key Machine, KM, 115V	95-M45000	\$16,782.00
Key Machine, Medeco X4, 115V	95-M55000	\$16,782.00
Key Machine, Medeco X4 A2/A4, 115V	95-M56000	\$17,381.00
Medeco KM Key Punch Machine	95-000200	\$4,569.00
Medeco X4 Key Punch Machine	95-001100	\$4,569.00

Power Key Machines are also available in 220V versions. Ask your customer service representative for details.
Note: Key Machines do not include keyway specific clamps. Must order from clamps shown below.



Key Machine Parts

Description	Part Number	Price
ITL 9700 M4 Insert - For M4 key cutting on the ITL 9700 and 9700A key machines	94-0326	\$288.00
Clamp Kit (Clamp, Handle, Plunger, QC Pin) - Medeco 4	95-210100-MED4	\$1,717.00
Clamp Retrofit Kit (Clamp, Handle, Plunger) - Medeco 4	95-210130-MED4	\$1,687.00
Clamp Kit (Clamp, Handle, Plunger, QC Pin) - Medeco ³	95-210100-MED3	\$1,717.00
Clamp Retrofit Kit (Clamp, Handle, Plunger) - Medeco ³	95-210130-MED3	\$1,687.00
Clamp Kit (Clamp, Handle, Plunger, QC Pin) - Universal (Selected Biax)	95-210100-UNIV	\$958.00
Clamp Retrofit Kit (Clamp, Handle, Plunger) - Universal (Selected Biax)	95-210130-UNIV	\$861.00
Clamp Kit (Clamp, Handle, Plunger, QC Pin) - Orig. and Biax. keyways	95-210100-XX	\$958.00
Clamp Retrofit Kit (Clamp, Handle, Plunger) - Orig. and Biax. keyways	95-210130-XX	\$861.00

Key Machine Cutters

Description	Part Number	Price
Cutter for all High Security technologies	95-100400	\$680.00
Cutter for Medeco X4 key machine	95-100070	\$680.00
Re-Sharpener Cutter - Must provide cutter for re-sharpening exchange	95-100400-SHARP	\$275.00

Product No.	Page	Product No.	Page	Product No.	Page	Product No.	Page
12286	195	3307350	160	100500H (P)	82	1065140 (P)	100
12288	195	5005511	28	100500H (S)	82	1065140 (P)	100
13327	195	5005521	28	100501 (P)	82	1065140 (S)	100
13346	195	5005531	28	100501 (S)	82	1065140 (S)	100
13365	195	5005541	28	100600 (P)	85	1065154 (P)	102
13375	195	5005711	28	100600 (S)	85	1065154 (S)	102
200503	26	5005721	28	100602 (P)	103	1065244 (P)	100
200901	24	5005731	28	100602 (S)	103	1065244 (S)	100
200901	27	5005741	28	100700	24	1065254 (P)	102
200902	24	6270515	160	100700 (P)	85	1065254 (S)	102
200902	27	6271515	160	100700 (S)	85	1066154 (P)	102
200904	27	12801006	82	100700 C	38	1066154 (S)	102
310100	26	12828006	82	100702 (P)	103	1066254 (P)	102
320201	26	12829006	82	100702 (S)	103	1066254 (S)	102
320201	29	50762011	29	100903 (P)	82	1075127 (P)	100
322201	26	50762014	29	100903 (S)	82	1075127 (S)	100
490435	61	50762111	29	100909 (P)	82	11-0018	128
490435	160	50762114	29	100909 (S)	82	11-0092	128
490436	61	50772011	29	1012040 (P)	101	11-0A10	128
490436	160	50772014	29	1012040 (S)	101	11-0A12	128
500020	28	50772111	29	101350	25	11-0A14	128
510600	28	50772114	29	101350 (P)	81	11-0A16	128
510800	28	52110040	147	101350 (S)	81	11-0A17	128
526000	145	52111040	147	101355 (P)	85	11-0A18	128
526002	145	52120040	147	101355 (S)	85	11-0A20	128
526010	145	52121040	147	10400 CUT H	197	11-0A21	128
526012	145	100100 (P)	81	10400 CUT J	197	11-0A22	128
526100	145	100100 (S)	81	104001 (P)	81	11-0A23	128
526102	145	100101 (P)	81	104001 (S)	81	110A00 (P)	127
526110	145	100101 (S)	81	104207 (P)	82	110A00 (S)	127
526112	145	100200	24	104207 (S)	82	110A01 (P)	127
526200	144	100200 (P)	81	104207A (P)	82	110A01 (S)	127
526202	144	100200 (S)	81	104207A (S)	82	110A02 (P)	127
526210	144	100200A (P)	82	105100	24	110A02 (S)	127
526212	144	100200A (S)	82	105100 (P)	81	110A03 (P)	127
526300	144	100202 (P)	82	105100 (S)	81	110A03 (S)	127
526302	144	100202 (S)	82	105100 C	38	110A04 (P)	127
526310	144	100300H (P)	85	105100 G	54	110A04 (S)	127
526312	144	100300H (S)	85	105104 (P)	81	110A05 (P)	127
650003	163	100300V (P)	85	105104 (S)	81	110A05 (S)	127
940010	85	100300V (S)	85	105200	24	110A06 (P)	127
940174	104	100305H (P)	85	105200 (P)	81	110A06 (S)	127
940210	128	100305H (S)	85	105200 (S)	81	110A07 (P)	127
940219	185	100305V (P)	85	105200 C	38	110A07 (S)	127
940243	185	100305V (S)	85	105300 (P)	81	110A08L	127
940261	53	100400H	24	105300 (S)	81	110A09L	127
940279	185	100400H (P)	85	105400	24	110A1911	127
1202800	127	100400H (S)	85	105400 (P)	81	110A1912	127
1202800	130	100400H C	38	105400 (S)	81	110A1913	127
1202900	127	100400H G	54	105400 C	38	110A1921	127
1202900	130	100400V	24	105500	24	110A1922	127
1236200	130	100400V (P)	85	105500 (P)	81	110A1923	127
1243400	130	100400V (S)	85	105500 (S)	81	11C28X	125
2020000	25	100400V C	38	105500 C	38	11C30L (P)	125
2020000	28	100400V G	54	105600 (P)	81	11C30L (S)	125
2020052	28	100403H	24	105600 (S)	81	11C30X (P)	125
2020073	25	100403H (S)	85	105700 (P)	81	11C30X (S)	125
2020074	28	100403H C	38	105700 (S)	81	11C31L (P)	125
2020078	26	100403V	24	105700 C	38	11C31L (S)	125
2020097	26	100403V (P)	85	105800 (P)	81	11C31X (P)	125
2020173	26	100403V (S)	85	105800 (S)	81	11C31X (S)	125
2021173	25	100403V C	38	105900 (P)	81	11C32L (P)	126
2080147	26	100500	24	105900 (S)	81	11C32L (S)	126
2080148	26	100500 (P)	81	105901 (P)	81	11C32X (P)	126
3307311	160	100500 (S)	81	105901 (S)	81	11C32X (S)	126
3307321	160	100500 C	38	105904 (P)	81	11C34X (P)	125
3307331	160	100500 G	54	105904 (S)	81	11C34X (S)	125

Product No.	Page	Product No.	Page	Product No.	Page	Product No.	Page
11C39X (P)	125	11C91X (S)	126	1251472P	104	200902 (S)	101
11C39X (S)	125	11C92X (P)	126	12814006	86	200902 C	42
11C40X	125	11C92X (S)	126	12832716	104	200903 (P)	94
11C42X	126	11C94X (P)	126	12847006	86	200903 (P)	100
11C601	27	11C94X (S)	126	2000400 (P)	98	200903 (P)	101
11C601 C	42	11R503 (P)	130	2000400 (S)	98	200903 (P)	101
11C602	27	11R503 (S)	130	2000700 (P)	98	200903 (P)	103
11C602 C	42	11R504 (P)	130	2000700 (S)	98	200903 (S)	94
11C603	27	11R504 (S)	130	2000800 (P)	102	200903 (S)	100
11C603 C	42	11R523 (P)	130	2000800 (S)	102	200903 (S)	101
11C604	27	11R523 (S)	130	2000827 (P)	96	200903 (S)	103
11C604 C	42	11R524 (P)	130	2000827 (S)	96	200903 (S)	101
11C605	27	11R524 (S)	130	2000854 (P)	102	200904 (P)	102
11C605 C	42	11R533 (P)	130	2000854 (S)	102	200904 (S)	102
11C606	27	11R533 (S)	130	2000900 (P)	102	200904 C	42
11C606 C	42	11R534 (P)	130	2000900 (S)	102	200907 (P)	101
11C60L	27	11R534 (S)	130	2000954	26	200907 (S)	101
11C60L (P)	125	11R57L	130	2000954 (P)	96	201006 (P)	95
11C60L (S)	125	11R5DL	130	2000954 (P)	100	201006 (S)	95
11C60L C	42	11R601	27	2000954 (P)	102	201006 G	186
11C60X (P)	125	11R601 C	42	2000954 (S)	96	20110039 (P)	90
11C60X (S)	125	11R602	27	2000954 (S)	100	20110039 (S)	90
11C61L (P)	125	11R602 C	42	2000954 (S)	102	2011281 G	186
11C61L (S)	125	11R603	27	2001200 (P)	91	2020000 (P)	103
11C61X (P)	125	11R603 (P)	130	2001200 (S)	91	2020000 (P)	148
11C61X (P)	125	11R603 (S)	130	2001300 (P)	91	2020000 (S)	103
11C61X (S)	125	11R603 C	42	2001300 (S)	91	2020000 (S)	148
11C61X (S)	125	11R604	27	2001400 (P)	98	2020000 C	39
11C621	27	11R604 (P)	130	2001400 (S)	98	2020000 C	41
11C621X (P)	126	11R604 (S)	130	200155 K	104	2020000 G	55
11C622	27	11R604 C	42	2001600 (P)	148	2020049	25
11C623	27	11R605	27	2001600 (S)	148	2020049 (P)	90
11C624	27	11R605 C	42	2001600 G	57	2020049 (P)	91
11C625	27	11R606	27	2001700 (P)	98	2020049 (P)	93
11C626	27	11R606 C	42	2001700 (S)	98	2020049 (P)	94
11C62L	27	11R60L	27	2001851 (P)	100	2020049 (P)	98
11C62L (P)	126	11R60L C	42	2001851 (S)	100	2020049 (S)	90
11C62L (S)	126	11R621	27	200500 (P)	99	2020049 (S)	91
11C62X (S)	126	11R622	27	200500 (S)	99	2020049 (S)	93
11C63L (P)	126	11R623	27	200503 (P)	99	2020049 (S)	94
11C63L (S)	126	11R623 (P)	130	200503 (S)	99	2020049 (S)	98
11C63LT (P)	126	11R623 (S)	130	200503 C	40	2020049 C	39
11C63LT (S)	126	11R624	27	200503 G	56	2020049 G	55
11C63X (P)	126	11R624 (P)	130	200700 (P)	98	2020051 (P)	94
11C63X (S)	126	11R624 (S)	130	200700 (S)	98	2020051 (P)	98
11C63XT (P)	126	11R625	27	200701 (P)	98	2020051 (S)	94
11C63XT (S)	126	11R626	27	200701 (S)	98	2020051 (S)	98
11C64X (P)	125	11R62L	27	200801 (P)	100	2020051 G	55
11C64X (S)	125	11R633 (P)	130	200801 (P)	101	2020052 (P)	98
11C69X (P)	125	11R633 (S)	130	200801 (S)	100	2020052 (P)	104
11C69X (S)	125	11R634 (P)	130	200801 (S)	101	2020052 (S)	98
11C70X	125	11R634 (S)	130	200802 (P)	100	2020052 (S)	104
11C71X	125	11R67L	130	200802 (P)	101	2020052 C	41
11C72X	126	11R6DL	130	200802 (S)	100	2020053 (P)	98
11C80X (P)	125	1200500 T	82	200802 (S)	101	2020053 (S)	98
11C80X (S)	125	1202000 T	82	200807 (P)	101	2020054 (P)	94
11C81X (P)	125	1202100 T	82	200807 (S)	101	2020054 (S)	94
11C81X (S)	125	1203000 T	86	200808 (P)	101	2020058 (P)	94
11C82X (P)	126	1212633 T	104	200808 (S)	101	2020058 (S)	94
11C82X (S)	126	1238900 J	86	200901 (P)	100	2020064 (P)	97
11C84X (P)	126	1238900P	86	200901 (P)	101	2020064 (S)	97
11C84X (S)	126	1239000 J	82	200901 (S)	101	2020068 (P)	94
11C89X (P)	126	1239100 J	82	200901 (S)	100	2020068 (S)	94
11C89X (S)	126	1251200 J	86	200901 C	42	2020070 (P)	90
11C90X (P)	126	1251200P	86	200902 (P)	100	2020070 (P)	95
11C90X (S)	126	1251300 J	82	200902 (P)	101	2020070 (S)	90
11C91X (P)	126	1251460J	104	200902 (S)	100	2020070 (S)	95

Product No.	Page	Product No.	Page	Product No.	Page	Product No.	Page
2020070 C	39	20200V0 (S)	96	20211730 (S)	92	2304015 (P)	194
2020071 (P)	90	20200V0 C	39	203000 (P)	96	2304015 (S)	194
2020071 (P)	94	20200V0 C	40	203000 (S)	96	2304016 (P)	194
2020071 (S)	90	20200V0 G	56	205003 (P)	92	2304016 (S)	194
2020071 (S)	94	20200V1	25	205003 (S)	92	2304025 (P)	194
2020072 (P)	94	20200V1	25	205004 (P)	92	2304025 (S)	194
2020072 (S)	94	20200V1	26	205004 (S)	92	2304026 (P)	194
2020073 (P)	90	20200V1 (P)	90	205005 (P)	92	2304026 (S)	194
2020073 (P)	92	20200V1 (P)	91	205005 (S)	92	2305016 (P)	194
2020073 (P)	94	20200V1 (P)	93	205005 C	39	2305016 (S)	194
2020073 (P)	95	20200V1 (P)	95	205006 (P)	92	2305015 G	58
2020073 (P)	98	20200V1 (P)	96	205006 (S)	92	2305015 G	186
2020073 (P)	99	20200V1 (P)	96	205008 (P)	92	2306016 (P)	194
2020073 (S)	90	20200V1 (S)	90	205008 (S)	92	2306016 (S)	194
2020073 (S)	92	20200V1 (S)	91	2051027 (P)	100	2306015 G	58
2020073 (S)	94	20200V1 (S)	93	2051027 (P)	103	23070165 (P)	194
2020073 (S)	95	20200V1 (S)	95	2051027 (S)	100	23070165 (S)	194
2020073 (S)	98	20200V1 (S)	96	2051027 (S)	103	23080166 (P)	194
2020073 (S)	99	20200V1 (S)	96	2051100 (P)	93	23080166 (S)	194
2020073 C	39	20200V1 C	38	2051100 (S)	93	2308015 G	58
2020073 G	55	20200V1 C	39	2051200 (P)	93	2309016 (P)	194
2020073 G	55	20200V1 C	40	2051200 (S)	93	2309016 (S)	194
2020074 (P)	104	20200V1 G	55	2051500 (P)	95	2310016 (P)	194
2020074 (S)	104	20200V1 G	55	2051500 (S)	95	2310016 (S)	194
2020074 C	41	20200V1 G	56	2052000 (P)	93	23130 CUT	197
2020078 (P)	95	20200V2	26	2052000 (S)	93	2313005 X00 (P)	192
2020078 (P)	99	20200V2 (P)	96	206005 (P)	101	2313005 X00 (S)	192
2020078 (S)	95	20200V2 (S)	96	206005 (P)	103	2313006 X00 (P)	192
2020078 (S)	99	20200V2 C	40	206005 (S)	101	2313006 X00 (S)	192
2020078 C	40	20200V2 G	56	206005 (S)	103	2313015 800 (P)	193
2020097 (P)	98	20200V3	25	206100 (P)	101	2313015 800 (S)	193
2020097 (S)	98	20200V3 (P)	94	206100 (P)	103	2313015 801 (P)	193
2020097 G	56	20200V3 (S)	94	206100 (S)	101	2313015 801 (S)	193
20200A1	24	20200V3 G	55	206100 (S)	103	2313016 800 (P)	193
20200A1 (P)	90	20200V9	25	207001 (P)	103	2313016 800 (S)	193
20200A1 (S)	90	20200V9 (P)	92	207001 (S)	103	2313016 801 (P)	193
20200A1 C	39	20200V9 (S)	92	208005 (P)	97	2313016 801 (S)	193
20200A1 G	55	20200V9 C	39	208005 (S)	97	2313025 X00 (P)	193
20200F1	25	20200V9 G	55	208006 (P)	97	2313025 X00 (S)	193
20200F1 (P)	94	2020149 (P)	96	208006 (S)	97	2313025 X01 (P)	193
20200F1 (S)	94	2020149 (S)	96	208007 (P)	97	2313025 X01 (S)	193
20200F1 G	55	2020169 (P)	95	208007 (S)	97	2313025 X02 (P)	193
20200H1 (P)	90	2020169 (S)	95	208008 (P)	90	2313025 X02 (S)	193
20200H1 (P)	98	2020170 (P)	97	208008 (S)	90	2313025 X11 (P)	193
20200H1 (S)	90	2020170 (S)	97	2080147 (P)	97	2313025 X11 (S)	193
20200H1 (S)	98	2020173 (P)	97	2080147 (S)	97	2313025 X12 (P)	193
20200L1	25	2020173 (S)	97	2080148 (P)	97	2313025 X12 (S)	193
20200L1 (P)	95	2020249 (P)	90	2080148 (S)	97	2313026 X00 (P)	193
20200L1 (S)	95	2020249 (P)	95	2080161 (P)	97	2313026 X00 (S)	193
20200L1 C	39	2020249 (P)	96	2080161 (S)	97	2313026 X01 (P)	193
20200L1 G	55	2020249 (P)	99	2080700 (P)	90	2313026 X01 (S)	193
20200S1	26	2020249 (S)	90	2080700 (P)	99	2313026 X02 (P)	193
20200S1 (P)	91	2020249 (S)	95	2080700 (S)	90	2313026 X02 (S)	193
20200S1 (P)	96	2020249 (S)	96	2080700 (S)	99	2313026 X12 (P)	193
20200S1 (P)	99	2020249 (S)	99	210503 (P)	151	2313026 X12 (S)	193
20200S1 (S)	91	2020249 C	39	210503 (S)	151	2313035 X00 (P)	192
20200S1 (S)	96	2020249 C	40	2301016 (P)	194	2313035 X00 (S)	192
20200S1 (S)	99	2020349 (P)	97	2301016 (S)	194	2313036 X00 (P)	192
20200S1 C	40	2020349 (S)	97	23010168 (P)	194	2313036 X00 (S)	192
20200S1 G	56	2020373 (P)	92	23010168 (S)	194	2313045 X00 (P)	192
20200V0	25	2020373 (S)	92	2303016A (P)	194	2313045 X00 (S)	192
20200V0	26	2020575 (P)	92	2303015 G	61	2313046 X00 (P)	192
20200V0 (P)	93	2020575 (S)	92	2303015 G	186	2313046 X00 (S)	192
20200V0 (P)	96	2020777 (P)	92	2304005 (P)	194	2313055 X00 (P)	192
20200V0 (P)	96	2020777 (S)	92	2304005 (S)	194	2313055 X00 (S)	192
20200V0 (S)	93	2021173 C	39	2304006 (P)	194	2313056 X00 (P)	192
20200V0 (S)	96	20211730 (P)	92	2304006 (S)	194	2313056 X00 (S)	192

Product No.	Page	Product No.	Page	Product No.	Page	Product No.	Page
2313065 X00 (P)	192	23230XS X11 G	61	320201 (P)	111	33-6B010 (S)	119
2313065 X00 (S)	192	23230XS X11 G	185	320201 (P)	127	33-6B01W (P)	119
2313066 X00 (P)	192	2324D21	168	320201 (P)	148	33-6B01W (S)	119
2313066 X00 (S)	192	2324D25	168	320201 (S)	111	33-6B070 (P)	119
2314003 (P)	194	2324H01	168	320201 (S)	127	33-6B070 (S)	119
2314003 (S)	194	2324H05	168	320201 (S)	148	33-7B010 (P)	119
2315005 (P)	194	2324S12X	168	320201H (P)	111	33-7B010 (S)	119
2315005 (S)	194	2324S15X	168	320201H (S)	111	33-7B01W (S)	119
2316004 (P)	194	2324S52X	168	320202 (P)	148	33-7B01W(P)	119
2316004 (S)	194	2325005 C	44	320202 (S)	148	33-7B070 (P)	119
2317016 (P)	194	2325025 C	44	320300H (P)	115	33-7B070 (S)	119
2317016 (S)	194	2326D21	168	320300H (S)	115	33-7B070S (P)	119
2320016 (P)	194	2326H01	168	320300V (P)	115	33-7B070S (S)	119
2320016 (S)	194	2326S12X	168	320300V (S)	115	33-7B07W (P)	119
2322015 300	185	31-0153H	116	320400H (P)	115	33-7B07W (S)	119
2322015 301	185	31-0153V	116	320400H (S)	115	33-7B07WS (P)	119
2322016 300	185	31-0175	114	320400V (P)	115	33-7B07WS (S)	119
2322016 300 S	30	31-0175A	114	320400V (S)	115	33600006 (P)	119
2322016 300 S	186	31-0375H	116	320405H (P)	115	33600006 (P)	127
2322016 301	185	31-0375S	116	320405H (S)	115	33600006 (S)	119
2322016 301 S	30	31-0375V	116	320600 (P)	115	33600006 (S)	127
2322016 301 S	186	31-5375	114	320600 (S)	115	33600007 (P)	119
2322017 300 N	185	310100 (P)	111	320700 (P)	115	33600007 (S)	119
2322017 301 N	185	310100 (S)	111	320700 (S)	115	3360000R (P)	168
232201S 300 G	61	310100 G	54	321200 (P)	113	3360000R (S)	168
232201S 300 G	186	310100A	26	321200 (S)	113	33602012 (P)	121
232201S 300 G	186	310100A (P)	111	321201 (P)	111	33602012 (S)	121
232201S 301 G	61	310100A (S)	111	321201 (S)	111	33602013 K (P)	121
232201S 301 G	186	310100A G	54	321350 (P)	113	33602013 K (S)	121
232201S 301 G	186	310101 (P)	113	321350 (S)	113	33602032 (P)	120
232201S 302 G	61	310101 (S)	113	322201 (P)	112	33602032 (S)	120
232201S 302 G	186	310101A (P)	113	322201 (S)	112	33602033 K (P)	120
232201S 302 G	186	310101A (S)	113	322201 C	41	33602033 K (S)	120
232202S 300 G	61	310102H (P)	115	322201 G	54	33602042 (P)	120
232202S 301 G	61	310102H (S)	115	322301 (P)	112	33602042 (S)	120
232202S 302 G	61	310102V (P)	115	322301 (S)	112	33602043 K (P)	120
23220X5 300	186	310102V (S)	115	322401 (P)	112	33602043 K (S)	120
23220X5 302	186	310104H (P)	115	322401 (S)	112	33602052 (P)	121
23220X6 300	186	310104H (S)	115	322801 (P)	112	33602052 (S)	121
23220XS 300	186	310104V (P)	115	322801 (S)	112	33602053 K (P)	121
232212SX 300 G	186	310104V (S)	115	324201 (P)	111	33602053 K (S)	121
232212SX 301 G	186	32-0175	114	324201 (S)	111	33602062 (P)	121
232222SX 302 G	186	32-0275	114	325200 (P)	113	33602062 (S)	121
2323016 800 S	30	32-0375H	116	325200 (S)	113	33602063 K (P)	121
2323016 801 S	30	32-0375V	116	325400 (P)	113	33602063 K (S)	121
232301S 800 G	61	32-0475H	116	325400 (S)	113	33700006 (P)	119
232301S 800 G	185	32-0475V	116	325500 (P)	113	33700006 (P)	127
232301S 801 G	61	32-0477H	116	325500 (S)	113	33700006 (S)	119
232301S 801 G	185	32-0675	116	325600 (P)	113	33700006 (S)	127
232301ST 800 G	61	32-0775	116	325600 (S)	113	33700007 (P)	119
232301ST 800 G	185	32-1375	114	325700 (P)	113	33700007 (S)	119
2323025 X00	185	32-5275	114	325700 (S)	113	3370000R (P)	168
2323026 X00	185	32-5375	114	32G2301 G	54	3370000R (S)	168
23230E5 X00 G	61	32-5475	114	32G2401 G	54	3370000S (P)	119
23230E5 X00 G	185	32-5575	114	33 6B07W (P)	119	3370000S (S)	119
23230E5 X11 G	61	32-5675	114	33 6B07W (S)	119	33702022 (P)	121
23230E5 X11 G	185	32-5775	114	33-07340	122	33702022 (S)	121
23230E6 X00 S	30	320100 (P)	113	33-076011	122	33702023 K (P)	121
23230E6 X00 S	185	320100 (S)	113	33-076021	122	33702023 K (S)	121
23230X5 X00	185	320101 (P)	111	33-076025	122	33702042 (P)	120
23230X6 X00	185	320101 (S)	111	33-076028	122	33702042 (S)	120
23230X6 X00 S	30	320101H (P)	111	33-07603H	122	33702043 K (P)	120
23230X6 X00 S	185	320101H (S)	111	33-076048	122	33702043 K (S)	120
23230X7 500	185	320200 (P)	113	33-07604H	122	337020B2 (P)	120
23230X7 511	185	320200 (S)	113	33-076051	122	337020B2 (S)	120
23230XS X00 G	61	320200B (P)	82	33-076061	122	337020C2 (P)	121
23230XS X00 G	185	320200B (S)	82	33-6B010 (P)	119	337020C2 (S)	121

Product No.	Page	Product No.	Page	Product No.	Page	Product No.	Page
337020E2 (P)	121	5005741 (S)	133	54515K0	137	600350T (P)	152
337020E2 (S)	121	5005741 G	57	54515L0	137	600350T (S)	152
490078 (P)	82	5008201 (P)	143	54515R0 (P)	137	600350T KIT (P)	151
490078 (S)	82	5008201 (S)	143	54515R0 (S)	137	600350T KIT (S)	151
490079 (P)	82	5008211 (P)	143	54515R0 G	57	600450T (P)	152
490079 (S)	82	5008211 (S)	143	54515X0	29	600450T (S)	152
490214 (P)	82	5009201 (P)	143	5451F00 (P)	137	600550T (P)	152
490214 (S)	82	5009201 (S)	143	5451F00 (S)	137	600550T (S)	152
490358 C	43	5009211 (P)	143	5451F00 G	57	600650269 G -XX	59
490359 C	43	5009211 (S)	143	5451FK0	137	600650T (P)	152
490359 G	58	510600 (P)	104	5451FL0	137	600650T (S)	152
490361 C	43	510600 (P)	148	5451FR0 (P)	137	600650T KIT (P)	151
490366 C	43	510600 (S)	104	5451FR0 (S)	137	600650T KIT (S)	151
490366 G	58	510600 (S)	148	5451FR0 G	57	600750T (P)	152
490368 C	43	510600 C	41	5451FX0	29	600750T (S)	152
490375 T	104	510600 G	57	5452500 (P)	139	600850T (P)	152
490423 G	60	510800 (P)	134	5452500 (S)	139	600850T (S)	152
490426 G	60	510800 (S)	134	5452500 G	57	600950T (P)	152
490428 G	58	510800 G	57	54525K0	139	600950T (S)	152
490429 G	58	526001 (P)	145	54525L0	139	601150T (P)	152
490431 G	58	526001 (S)	145	54525R0 (P)	139	601150T (S)	152
490432 G	60	526011 (P)	145	54525R0 (S)	139	601150T KIT (P)	151
490437 G	60	526011 (S)	145	54525R0 G	57	601150T KIT (S)	151
50-0551L	134	526101 (P)	145	54525X0	29	601250T (P)	152
50-0552L	134	526101 (S)	145	5461500 (P)	137	601250T (S)	152
50-0553L	134	526111 (P)	145	5461500 (S)	137	601251T (P)	152
50-0554L	134	526111 (S)	145	54615K0	137	601251T (S)	152
50-0571L	134	526201 (P)	144	54615L0	137	601450T (P)	152
50-0572L	134	526201 (S)	144	54615R0 (P)	137	601450T (S)	152
50-0573L	134	526211 (P)	144	54615R0 (S)	137	601450T KIT (P)	151
50-0574L	134	526211 (S)	144	54615X0	29	601450T KIT (S)	151
50-74201	143	526301 (P)	144	5461F00 (P)	137	601452T (P)	152
50-74211	143	526301 (S)	144	5461F00 (S)	137	601452T (S)	152
50-75201	143	526311 (P)	144	5461FK0	137	60300 CUT W 219	197
50-75211	143	526311 (S)	144	5461FL0	137	607155XT (P)	154
500020 (P)	149	5292000 (P)	146	5461FR0 (P)	137	607155XT (S)	154
500020 (S)	149	5292000 (S)	146	5461FR0 (S)	137	607255XT (P)	154
5002201 (P)	143	5292001 (P)	146	5461FX0	29	607255XT (S)	154
5002201 (S)	143	5292001 (S)	146	5471500 (P)	139	607355XT (P)	154
5002211 (P)	143	5292100 (P)	146	5471500 (S)	139	607355XT (S)	154
5002211 (S)	143	5292100 (S)	146	5471500 G	57	607455XT (P)	154
5003201 (P)	143	5292101 (P)	146	54715K0	139	607455XT (S)	154
5003201 (S)	143	5292101 (S)	146	54715L0	139	607555XT (P)	154
5003211 (P)	143	5293000 G	57	54715R0 (P)	139	607555XT (S)	154
5003211 (S)	143	5431500 (P)	138	54715R0 (S)	139	60810 XXX C	43
5005511 (P)	133	5431500 (S)	138	54715R0 G	57	60810D XXX C	43
5005511 (S)	133	54315K0	138	54715X0	29	60820 XXX C	43
5005511 G	57	54315L0	138	5471F00 (P)	139	60820D XXX C	43
5005521 (P)	133	54315R0 (P)	138	5471F00 (S)	139	6210555 G XX	58
5005521 (S)	133	54315R0 (S)	138	5471F00 G	57	6210555T (P)	160
5005521 G	57	5431F00 (P)	138	5471FK0	139	6210555T (S)	160
5005531 (P)	133	5431F00 (S)	138	5471FL0	139	6211555 G XX	58
5005531 (S)	133	5431FK0	138	5471FR0 (P)	139	6211555T (P)	160
5005531 G	57	5431FL0	138	5471FR0 (S)	139	6211555T (S)	160
5005541 (P)	133	5431FR0 (P)	138	5471FR0 G	57	6212555 G XX	58
5005541 (S)	133	5431FR0 (S)	138	5471FX0	29	6212555T (P)	160
5005541 G	57	5433500 (P)	138	5472500 (P)	139	6212555T (S)	160
5005711 (P)	133	5433500 (S)	138	5472500 (S)	139	6221554T (P)	161
5005711 (S)	133	54335R0 (P)	138	5472500 G	57	6221554T (S)	161
5005711 G	57	54335R0 (S)	138	54725K0	139	6221557T (P)	161
5005721 (P)	133	5433F00 (P)	138	54725L0	139	6221557T (S)	161
5005721 (S)	133	5433F00 (S)	138	54725R0 (P)	139	6261557T (P)	161
5005721 G	57	5433FR0 (P)	138	54725R0 (S)	139	6261557T (S)	161
5005731 (P)	133	5433FR0 (S)	138	54725R0 G	57	6280550 G	58
5005731 (S)	133	5451500 (P)	137	54725X0	29	6280550 G -XX	59
5005731 G	57	5451500 (S)	137	600250T (P)	152	6282550 G	58
5005741 (P)	133	5451500 G	57	600250T (S)	152	6282550 G -XX	59

Product No.	Page	Product No.	Page	Product No.	Page	Product No.	Page
640155CT (P)	158	66391 (S)	148	94-51108R-P47-26	160	CP-020010	86
640155CT (S)	158	66391 (S)	154	94-51109R-P47-26	160	CP-020020	104
640155T (P)	158	66391 (S)	160	95-000200	204	CP-020031	195
640155T (S)	158	66418 (P)	148	95-001100	204	CP-020040	104
640250T (P)	156	66418 (S)	148	95-100070	204	CP-020100	104
640250T (S)	156	90-0001	203	95-100400	204	CP-020240	195
640251T (P)	156	90-0028	197	95-210100-MED3	204	CP-021011	85
640251T (S)	156	94-0020	148	95-210100-MED4	204	CP-021031	104
640550AT (P)	156	94-0029	128	95-210100-UNIV	204	CP-021121	86
640550AT (S)	156	94-0030	128	95-210100-XX	204	CP-021130	104
640550FT (P)	156	94-0034	108	95-210130-MED3	204	CP-021370	104
640550FT (S)	156	94-0035	108	95-210130-MED4	204	CP-021400	195
640550T (P)	156	94-0036	108	95-210130-UNIV	204	CP-021490	195
640550T (S)	156	94-0051	108	95-210130-XX	204	CP-021651	104
640750ET (P)	158	94-0052	148	95-M11000	204	CP-022030	148
640750ET (S)	158	94-0058-MED	127	95-M23000	204	CP-030001	195
640750GT (P)	158	94-0059	127	95-M34000	204	CP-030001	201
640750GT (S)	158	94-0061	108	95-M45000	204	CP-030017	201
640950T (P)	158	94-0067	108	95-M55000	204	CP-030018	85
640950T (S)	158	94-0098	108	95-M56000	204	CP-030018	86
640952T (P)	158	94-0171	64	960357 (P)	148	CP-030018	201
640952T (S)	158	94-0174-XX	85	960357 (S)	148	CP-030024	195
641050T (P)	158	94-0174-XX	86	960358 (P)	148	CP-030025	195
641050T (S)	158	94-0174-XX	202	960358 (S)	148	CP-030042	201
641051T (P)	158	94-0188-XX	87	960590 W 26-56	71	CP-030430	148
641051T (S)	158	94-0199	148	CARD 1 X XX	197	CP-030590	201
641200 C	41	94-0203	189	CARD 2 X XX	197	CP-030670	104
641200 C	44	94-0207	189	CARD 6 X XX	197	CP-030860	191
641200D C	44	94-0207	203	CARD KS XX 8E	197	CP-030860	195
641201 C	41	94-0208	189	CARD XX 56 XX	197	CP-030910	201
641201 C	44	94-0212	128	CARD XX 66 XX	197	CP-031030	195
641201D C	44	94-0213	147	CB-CODE-BIA	197	CP-031170	201
652150T 011 (P)	163	94-0221	189	CB-CODE-BOK	197	CP-031480	201
652150T 011 (S)	163	94-0222	189	CN-DIES	196	CP-031560	201
652150T 012 (P)	163	94-0223	189	CP-010103-040	202	CP-041200	104
652150T 012 (S)	163	94-0227-XX	85	CP-010203-030	202	CP-050050	163
652150T 021 (P)	163	94-0227-XX	86	CP-010203-050	85	CP-050060	156
652150T 021 (S)	163	94-0227-XX	202	CP-010203-050	104	CP-050120	85
6522560 G-121-XX	59	94-0249	45	CP-010203-050	202	CP-060106	191
6522560 G-122-XX	59	94-0255-XX	202	CP-010234-320	128	CP-060203	86
6522560T 121 (P)	165	94-0256-XX	202	CP-010235-120-XX	128	CP-063220	189
6522560T 121 (S)	165	94-0261	197	CP-010503-040	104	CP-063220	191
6522560T 122 (P)	165	94-0269	197	CP-010503-040	202	CP-064231	202
6522560T 122 (S)	165	94-0272	108	CP-011011-020	85	CP-064490	104
6522560T 132 (P)	165	94-0283	186	CP-011011-020	86	CP-064701	202
6522560T 132 (S)	165	94-0285	189	CP-011011-020	202	CP-070011	87
6522560T 133 (P)	165	94-0287	185	CP-011013-020	85	CP-070111	157
6522560T 133 (S)	165	94-0288	185	CP-011013-020	86	CP-070131	157
6522560T 134 (P)	165	94-0289	185	CP-011013-020	195	CP-070141	157
6522560T 134 (S)	165	94-0290	53	CP-011013-020	202	CP-070161	157
6522560T 221 (P)	165	94-0291	53	CP-011013-040	195	CP-070171	157
6522560T 221 (S)	165	94-0292	53	CP-011013-040	202	CP-070181	157
652650T 101 (P)	163	94-0304-M0P	33	CP-011511-000	148	CP-070201	157
652650T 101 (S)	163	94-0304-MBP	33	CP-011751	128	CP-070441	157
652650T 102 (P)	163	94-0305-M0P	33	CP-011753	128	CP-070451	87
652650T 102 (S)	163	94-0305-MBP	33	CP-011754	128	CP-070481	157
652650T 111 (P)	163	94-0306	51	CP-011757	128	CP-070501	157
652650T 111 (S)	163	94-0307	51	CP-011762	128	CP-070691	128
652650T 131 (P)	163	94-0309	197	CP-011763	128	CP-070701	128
652650T 131 (S)	163	94-0316	134	CP-011764	128	CP-070711	129
652650T 132 (P)	163	94-0317-516	134	CP-011767	128	CP-070721	129
652650T 132 (S)	163	94-0317-716	134	CP-012409-030	195	CP-070731	129
652650T 133 (P)	163	94-0318	134	CP-012411-030	195	CP-070741	129
652650T 133 (S)	163	94-0323	203	CP-012411-040	195	CP-084571	85
66391 (P)	148	94-0325	51	CP-012917-000	86	CP-084571	86
66391 (P)	154	94-0326	204	CP-014213-061	134	CP-084571	202
66391 (P)	160	94-51106R-P47-05	160	CP-014642-591	134	CP-0845A0	202

Product No.	Page	Product No.	Page	Product No.	Page	Product No.	Page
CP-084671	85	CP-170021	201	CP-200771-10	188	CP-270521	163
CP-084671	86	CP-170021	202	CP-200771-10	191	CP-270531	163
CP-084671	202	CP-170031	201	CP-200771-15	188	CP-270541	163
CP-0846A0	202	CP-170031	202	CP-200771-15	191	CP-270551	163
CP-100111	195	CP-170041	201	CP-200771-20	188	CP-270561	163
CP-100761	195	CP-170041	202	CP-200771-20	191	CP-280261	195
CP-100771-Z00	60	CP-170051	201	CP-200771-25	188	CP-280271	29
CP-100771-Z01	60	CP-170061	201	CP-200771-25	191	CP-280271	148
CP-100771-Z02	60	CP-170250	148	CP-200801-00	188	CP-280330	189
CP-100771-Z20	60	CP-170271	201	CP-200801-02	188	CP-280620	129
CP-100771-Z34	60	CP-170430	201	CP-200801-04	188	CP-282430	203
CP-100781-Z00	60	CP-170440	201	CP-200801-06	188	CP-282451	203
CP-100781-Z01	60	CP-170481	201	CP-200801-08	188	CP-282460	202
CP-100781-Z02	60	CP-170730-5	189	CP-200801-0A	188	CP-282470	202
CP-100781-Z20	60	CP-170730-5	201	CP-200801-12	191	CP-282500	203
CP-100781-Z34	60	CP-170730-6	189	CP-200801-14	191	CP-282530	203
CP-130101	148	CP-170730-6	201	CP-200801-16	191	CP-282540	203
CP-130510	148	CP-170930	35	CP-200801-18	191	CP-284490	64
CP-142043	149	CP-170930	45	CP-200801-1A	191	CP-285901	190
CP-142543	149	CP-170930	53	CP-200801-22	188	CP-285901	195
CP-144110	149	CP-171011	149	CP-200801-24	188	CP-285921-500	190
CP-144120	149	CP-171021	149	CP-200801-26	188	CP-285921-500	195
CP-144130	149	CP-171031	149	CP-200801-28	188	CP-285931	190
CP-144140	149	CP-180021	87	CP-200801-2A	188	CP-285931	195
CP-144150	149	CP-180031	86	CP-200801-44	188	CP-285951-500	190
CP-144160	149	CP-180041	87	CP-200801-46	188	CP-285951-500	195
CP-144170	149	CP-180061	129	CP-200801-48	188	CP-285961	190
CP-144180	149	CP-200720	148	CP-200801-4A	188	CP-285961	195
CP-144190	149	CP-200751-10	187	CP-200801-66	188	CP-285981-500	190
CP-144200	149	CP-200751-10	191	CP-200801-68	188	CP-285981-500	195
CP-144210	149	CP-200751-15	187	CP-200801-6A	188	CP-285991	190
CP-144220	149	CP-200751-15	191	CP-200801-88	188	CP-285991	195
CP-144230	134	CP-200751-20	187	CP-200801-8A	188	CP-286011-500	190
CP-144240	134	CP-200751-20	191	CP-200801-AA	188	CP-286011-500	195
CP-144250	134	CP-200751-25	187	CP-200830	191	CP-286021	190
CP-144260	134	CP-200751-25	191	CP-200851-10	188	CP-286041-500	190
CP-144270	134	CP-200751-30	187	CP-200851-15	188	CP-286041-500	195
CP-144280	134	CP-200751-40	187	CP-200851-20	188	CP-286051	190
CP-144290	134	CP-200751-45	187	CP-200851-25	188	CP-286071-500	190
CP-144300	134	CP-200751-50	187	CP-200851-30	188	CP-286080	64
CP-145040	134	CP-200751-55	187	CP-200851-45	188	CP-286131	197
CP-150082	163	CP-200751-60	187	CP-200851-55	188	CP-286170	64
CP-150102	163	CP-200751-65	187	CP-200851-60	188	CP-286180	53
CP-150142	163	CP-200751-70	187	CP-200851-65	188	CP-286180	64
CP-150152	163	CP-200751-75	187	CP-200851-70	188	CP-286190	64
CP-160051	157	CP-200751-80	187	CP-200851-75	188	CP-286350	203
CP-160061	157	CP-200751-85	187	CP-200851-80	188	CP-286550	64
CP-160071	157	CP-200751-90	187	CP-200851-85	188	CP-286851	203
CP-160081	157	CP-200761-05	187	CP-200851-90	188	CP-287260	35
CP-160091	157	CP-200761-10	187	CP-220071	189	CP-287260	45
CP-160101	157	CP-200761-15	187	CP-220071	195	CP-287260	53
CP-160111	157	CP-200761-20	187	CP-220090	191	CP-287371	203
CP-160121	157	CP-200761-25	187	CP-220090	195	CP-287720	134
CP-160180	87	CP-200761-30	187	CP-220120	195	CP-287770	134
CP-160271	157	CP-200761-40	187	CP-220201	195	CP-301290	48
CP-160301	157	CP-200761-45	187	CP-230081	195	CP-301290	49
CP-160541	157	CP-200761-50	187	CP-230091	195	CP-301290	53
CP-160551	157	CP-200761-55	187	CP-240761-500	190	CP-301290	64
CP-160571	157	CP-200761-60	187	CP-240771-5P	189	CP-301350	64
CP-160591	157	CP-200761-65	187	CP-240771-6P	189	CT-A00	154
CP-160601	157	CP-200761-70	187	CP-250010	129	CT-A01	154
CP-160611	157	CP-200761-75	187	CP-250020	129	CT-A02	154
CP-160661-50	191	CP-200761-80	187	CP-250030	148	CT-A03	154
CP-160661-55	191	CP-200761-85	187	CP-250040	148	CT-A04	154
CP-160691	148	CP-200761-90	187	CP-250140	148	CT-A05	154
CP-160910	134	CP-200771-05	188	CP-250180	134	CT-A06	154
CP-170011	201	CP-200771-05	191	CP-270511	163	CT-A07	154

Product No.	Page	Product No.	Page	Product No.	Page	Product No.	Page
CT-A08	154	CT-V03	105	CT-Z56	84	EA-100229	35
CT-A09	154	CT-V19	105	CT-Z57	84	EA-100232	53
CT-A11	154	CT-V35	105	CT-Z58	84	EA-100234	64
CT-A12	154	CT-V39	105	CT-Z59	84	EA-100235	64
CT-A13	154	CT-V40	105	CT-Z61	84	EA-100236-M00	68
CT-A14	154	CT-Y02	87	CT-Z69	84	EA-100236-M01	68
CT-A15	154	CT-Y08	87	CT-Z70	84	EA-100236-MD0	68
CT-A16	154	CT-Y08	105	CT-Z84	84	EA-100236-MD1	68
CT-A19	154	CT-Y24	106	CT-Z87	84	EA-100236-MU0	68
CT-C02	155	CT-Y27	106	CT-Z88	191	EA-100236-MU1	68
CT-C04	155	CT-Y28	106	CT-Z88	195	EA-100237-M00	68
CT-C05	155	CT-Y29	106	CT-Z98	185	EA-100237-M01	68
CT-C08	155	CT-Y31	106	CT-Z98	195	EA-100237-MD0	68
CT-C09	155	CT-Y32	87	CT-Z99	84	EA-100237-MD1	68
CT-C11	155	CT-Y35	106	CT-ZA2	195	EA-100237-MU0	68
CT-D00	155	CT-Y37	106	CT-ZA6	84	EA-100237-MU1	68
CT-D01	155	CT-Y46	106	DE-CODE-KEY	196	EA-100240	62
CT-D02	155	CT-Y47	106	DE-CODE-LOK	196	EA-100242-000	52
CT-D03	155	CT-Y49	106	EA-100088	53	EA-100242-010	52
CT-D04	155	CT-Y52	106	EA-100108	54	EA-100242-100	52
CT-D05	155	CT-Y53	106	EA-100109	48	EA-100245	52
CT-D06	155	CT-Y54	106	EA-100109	49	EA-100247-A00	68
CT-D07	155	CT-Y55	106	EA-100109	52	EA-100247-A01	68
CT-D08	155	CT-Y57	106	EA-100110	197	EA-100247-M00	68
CT-D09	155	CT-Y58	107	EA-100111	197	EA-100247-M01	68
CT-D11	155	CT-Y60	129	EA-100117	71	EA-100247-MD0	68
CT-D12	155	CT-Y61	129	EA-100121	45	EA-100247-MD0	68
CT-D15	155	CT-Y67	107	EA-100125	52	EA-100247-MU0	68
CT-D19	155	CT-Y68	107	EA-100126	35	EA-100247-MU1	68
CT-F34	105	CT-Y69	107	EA-100138	53	EA-100248-A00	68
CT-F35	105	CT-Y70	107	EA-100142	35	EA-100248-A01	68
CT-F36	105	CT-Y71	107	EA-100145	45	EA-100248-M00	68
CT-F37	105	CT-Y72	107	EA-100148	71	EA-100248-M01	68
CT-F38	105	CT-Y73	107	EA-100149	71	EA-100248-MD0	68
CT-F40	105	CT-Y74	107	EA-100154	71	EA-100248-MD1	68
CT-F42	129	CT-Y75	107	EA-100159	45	EA-100248-MU0	68
CT-F43	129	CT-Y76	195	EA-100160	35	EA-100248-MU1	68
CT-F44	129	CT-Y77	107	EA-100167	45	EA-100249-A00	68
CT-H00	155	CT-Y78	107	EA-100168	35	EA-100249-A01	68
CT-H07	155	CT-Y97	107	EA-100173	51	EA-100249-M00	68
CT-H09	155	CT-Z00	83	EA-100173	197	EA-100249-M01	68
CT-H14	155	CT-Z01	83	EA-100174	51	EA-100249-MD0	68
CT-H15	155	CT-Z02	83	EA-100174	197	EA-100249-MD1	68
CT-H16	155	CT-Z04	83	EA-100177	51	EA-100249-MU0	68
CT-H17	155	CT-Z05	83	EA-100178	51	EA-100249-MU1	68
CT-H19	155	CT-Z06	83	EA-100179	35	EA-100250-A00	68
CT-H20	155	CT-Z07	83	EA-100180	35	EA-100250-A01	68
CT-H27	155	CT-Z08	83	EA-100181	35	EA-100250-M00	68
CT-H30	155	CT-Z09	83	EA-100182	35	EA-100250-M01	68
CT-H32	155	CT-Z16	83	EA-100192	63	EA-100250-MD0	68
CT-J01	156	CT-Z17	83	EA-100199-A00	68	EA-100250-MD1	68
CT-J05	156	CT-Z18	83	EA-100199-A01	68	EA-100250-MU0	68
CT-J07	156	CT-Z19	83	EA-100199-M00	68	EA-100250-MU1	68
CT-J08	156	CT-Z20	83	EA-100199-M01	68	EA-100254	51
CT-J11	156	CT-Z21	83	EA-100199-MD0	68	EA-100259-A00	69
CT-J12	156	CT-Z22	83	EA-100199-MD1	68	EA-100259-A01	69
CT-J13	156	CT-Z26	195	EA-100199-MU0	68	EA-100259-M00	69
CT-J14	156	CT-Z29	195	EA-100199-MU1	68	EA-100259-M01	69
CT-J15	156	CT-Z34	84	EA-100200	64	EA-100259-MD0	69
CT-J18	156	CT-Z45	84	EA-100206	62	EA-100259-MD1	69
CT-J22	156	CT-Z47	84	EA-100207	62	EA-100259-MU0	69
CT-J27	156	CT-Z48	84	EA-100208	62	EA-100259-MU1	69
CT-J28	156	CT-Z50	189	EA-100210	35	EA-100260-A00	69
CT-J29	156	CT-Z50	195	EA-100219	58	EA-100260-A01	69
CT-V00	105	CT-Z51	189	EA-100220	61	EA-100260-M00	69
CT-V01	105	CT-Z51	195	EA-100221	61	EA-100260-M01	69
CT-V02	105	CT-Z55	84	EA-100222	35	EA-100260-MD0	69

Product No.	Page	Product No.	Page	Product No.	Page	Product No.	Page
EA-100260-MD1	69	EN-400001	64	KYB 10X600 XX XX	198	SW-500701-1	70
EA-100260-MU0	69	EN-400002	64	KYB 10X605 XX	198	SW-600801	46
EA-100260-MU1	69	EN-400004	64	KYB 115400 S6 43	198	SW-600801-6	34
EA-100261-A00	69	EN-400005	64	KYB 115400 XX 00	198	SW-600801-6R	34
EA-100261-A01	69	EN-400006	64	KYB 12X600 XX 99	198	SW-600801-6R	46
EA-100261-M00	69	EN-400007	64	KYB 17X600 XX 99	198	SW-600801-7	34
EA-100261-M01	69	EP-1210	64	KYB 32X600 XX 99	198	SW-600801-7	46
EA-100261-MD0	69	EP-1211	64	KYB 32X900 XX 99	198	SW-600801-7R	34
EA-100261-MD1	69	EV-5507	64	KYB 33X600 XX 99	198	SW-600801-7R	46
EA-100261-MU0	69	EV-8000D	64	KYB 34X600 XX 99	198	SW-600901	49
EA-100261-MU1	69	EV-8501D	57	KYB 38X600 XX 99	198	SW-600901	64
EA-100262-A00	69	EV-8501D	58	KYB 38X900 XX 99	198	SW-600901-1	49
EA-100262-A01	69	EV-8501S	57	KYB 4L X600 XX 99 XXX	198	SW-600901-1R	49
EA-100262-M00	69	EV-8501S	58	KYB 4S X600 XX 99 XXX	198	SW-600901-2	49
EA-100262-M01	69	.K-1001	200	KYB A50000-AXX00	198	SW-600901-R	49
EA-100262-MD0	69	.K-1002	200	KYB A60000-AXX00	198	SW-601201	34
EA-100262-MD1	69	.K-1003	200	KYB XX5400 XX 99	198	SW-601201-R	34
EA-100262-MU0	69	.K-1005	200	KYB XX611	111	SW500101-1	46
EA-100262-MU1	69	.K-1006	200	KYB XX6605	129	SW500101-3	46
EA-100263-A00	69	.K-1099	202	KYB XX6620 XX 05	112	SW500101-5	46
EA-100263-A01	69	.K-4001	199	KYB XX6X31	112	T-7155	203
EA-100263-M00	69	.K-4002	199	KYB XX7X11	111	TP-F10-1T	200
EA-100263-M01	69	.K-4003	199	KYB XX7X31	112	TP-F10-2T	200
EA-100263-MD0	69	.K-4004	199	KYC 4L X600 XX 99 XXX	196	TP-F10-2T	200
EA-100263-MD1	69	.K-4006	199	KYC 4L X600 XX XX XXX	196	TP-F10-2W (.060")	190
EA-100263-MU0	69	.K-6001	200	KYC 4S X600 XX 99 XXX	196	TP-F10-3T	200
EA-100263-MU1	69	.K-6002	200	KYC 4S X600 XX XX XXX	196	TP-F10-3W (.090")	190
EA-100264-A00	69	.K-9001	199	KYC A50000 AXX 00	196	TP-F10-4T	200
EA-100264-A01	69	.KJ1501	199	KYC A60000 AXX 00	196	TP-F10-4T (.180")	190
EA-100264-M00	69	.KW5005	199	KYC XX5600 XX 99	196	TP-F10-4W-6T (.120")	190
EA-100264-M01	69	.KW5006	199	KYC XX6600 XX XX	196	TP-F10-4W-6T	200
EA-100264-MD0	69	.KW5007	199	KYC XX6900 XXX 99	196	TP-F10-5T (.150")	190
EA-100264-MD1	69	.KW5010	199	KYC XX6900 XXX XX	196	TP-F10-5T	200
EA-100264-MU0	69	.KW5011	199	PK-KYLUBE-02	53	TP-F10-XT	200
EA-100264-MU1	69	.KW5012	199	PK-KYLUBE-11	53	TP-F10-XW	200
EA-100265-A00	69	.KW5401	35	PX-KYLUBE-02	203	TP-F10-XX	200
EA-100265-A01	69	.KW5401	185	PX-KYLUBE-11	203	TP-F15-XB	200
EA-100265-M00	69	.KW5401	199	RE-KEY	196	TP-F15-XT	200
EA-100265-M01	69	.KW9003	199	RE-KEY-MK	196	TP-F50-XW	200
EA-100265-MD0	69	KEB 47600C	33	SMK004-01	72	TP-F50-XX	200
EA-100265-MD1	69	KEB 48600C	33	SMK004-02	72	TP-F53-XX	200
EA-100265-MU0	69	KEB 49600C	33	SMK032-31	72	TP-F57-0	200
EA-100265-MU1	69	KEC 42602B	45	SMK032-33	72	TP-F57-X	200
EA-200058	48	KEC 42603B	45	SMK032-35	72	TP-F60-XX	200
EA-200058	49	KEC 4260CR	45	SMK032-37	72	TP-F90-XX	200
EA-250059	49	KEC 426P2B	45	SMK040-30	72	TP-H10-9W (.135")	190
EA-250066	70	KEC 426P3B	45	SMK040-31	72	TP-K40-XX-BH	200
EA-300071	64	KEC 47X003	33	SMK042-30	72	TP-K40-XX-TH	200
EA-300239	70	KEC 47X013	33	SMK042-32	72	TP-K42-Z9	200
EA-300241	52	KEC 47X023	33	SMK042-33	72	TP-K43-XX-BH	200
EA-300242	70	KEC 47XB03	31	SMK042-35	72		
EA-300243	70	KEC 47XP03	33	ST-LASER	196		
EA-300244	70	KEC 48X003	33	SW-500101-1	34		
EA-300245	70	KEC 48X013	33	SW-500101-3	34		
EA-300254	70	KEC 48X023	33	SW-500101-5	34		
EA-300255	70	KEC 48XB03	31	SW-500141	68		
EA-300256	70	KEC 48XP03	33	SW-500141-1	68		
EA-300257	70	KEC 497043	33	SW-500141-1R	68		
EA-350084	33	KEC 49X003	33	SW-500150-R	34		
EA-500054-M0P	33	KEC 49X013	33	SW-5001570	35		
EA-500054-MBP	33	KEC 49XB03	31	SW-500170-R	35		
EN-100000	64	KEC 49XP03	33	SW-500301-1	49		
EN-100002-219	64	KH-5701	199	SW-500301-1R	49		
EN-100003-219	64	KH-5702	199	SW-500301-2	48		
EN-150002-XXX	52	KM-SHARP-CUT	196	SW-500301-3	48		
EN-150002-XXX (Op Code)	59	KM-SHARP-CUT	204	SW-500301-3	64		
EN-150003-XXX (Op Code)	59	KYB 105400 XX 00	198	SW-500301-4	48		

Finishes Available – Commercial & Industrial Locks



05
(US03)
Bright Brass



06
(US04)
Satin Brass



09
(US5)
Antique Brass



10
Satin Brass
Blackened

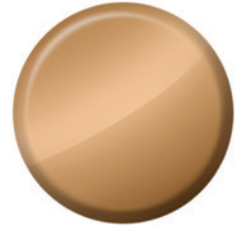

11
(US9)
Bright Bronze



12
(US10)
Satin Bronze



13
(US10B)
Dark Bronze/
Oil Rubbed



18
(US14)
Bright Nickel



19
(US15)
Satin Nickel

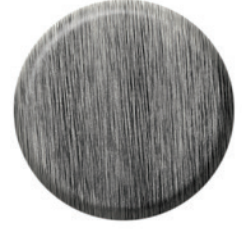

20
(US15A)
Antique Nickel



22
Flat Black



24
(US20A)
Dark Bronze/
Clear Coat



25
(US26)
Bright Chrome



26
(US26D)
Satin Chrome



BB
Matte Black

Note: Product appearance may differ from this chart as a result of the differences in plated versus printed materials.

Legacy Technology Pricing 2025

Part Number

Original & Biaxial

Keymark

100100-P	202.65	141.26
100100-S	186.15	124.76
100101-P	202.65	
100101-S	186.15	
100200 M		
100200 S		
100200A-P	315.05	224.53
100200A-S	298.55	208.03
100200-P	202.65	141.26
100200-S	186.15	124.76
100202-P	231.12	168.06
100202-S	214.62	151.56
100300H-P	209.22	153.89
100300H-S	192.72	137.39
100300V-P	209.22	153.89
100300V-S	192.72	137.39
100305H-P	209.22	
100305H-S	192.72	
100305V-P	209.22	
100305V-S	192.72	
100400H C		
100400H G		
100400H M		
100400H S		
100400H-P	221.26	152.91
100400H-S	204.76	136.41
100400V C		
100400V G		
100400V M		
100400V S		

Part Number	Original & Biaxial	Keymark
-------------	--------------------	---------

100400V-P	221.26	152.91
100400V-S	204.76	136.41
100403H C		
100403H S		
100403H-P	221.26	152.91
100403H-S	204.76	136.41
100403V C		
100403V S		
100403V-P	221.26	152.91
100403V-S	204.76	136.41
100500 C		
100500 G		
100500 M		
100500 S		
100500H-P	260.97	
100500H-S	244.47	
100500-P	211.41	144.35
100500-S	194.91	127.85
100501-P	251.93	
100501-S	235.43	
100600-P	221.26	
100600-S	204.76	
100602-P	189.51	132.89
100602-S	173.01	116.39
100700 C		
100700 S		
100700-P	221.26	152.91
100700-S	204.76	136.41
100702-P	198.27	136.88
100702-S	181.77	120.38
100903-P	225.65	
100903-S	209.15	
100909-P	257.4	
100909-S	240.9	
1012040-P	202.65	
1012040-S	186.15	
101350 M		

Part Number	Original & Biaxial	Keymark
-------------	--------------------	---------

101350-P	265.06	212.19
101350-S	248.56	195.69
101355-P	281.49	
101355-S	264.99	
1014500-P	202.65	
1014500-S	186.15	
1014501-P	211.41	
1014501-S	194.91	
1014502-P	219.07	
1014502-S	202.57	
1014503-P	297.92	
1014503-S	281.42	
1014504-P	303.39	
1014504-S	286.89	
1014505-P	311.06	
1014505-S	294.56	
1014506-P	202.65	
1014506-S	186.15	
1014507-P	323.1	
1014507-S	306.6	
1014508-P	334.05	
1014508-S	317.55	
1014600-P	202.65	
1014600-S	186.15	
1014601-P	211.41	
1014601-S	194.91	
1014602-P	219.07	
1014602-S	202.57	
1014603-P	297.92	
1014603-S	281.42	
1014604-P	303.39	
1014604-S	286.89	
1014605-P	311.06	
1014605-S	294.56	
1014607-P	323.1	
1014607-S	306.6	
1014608-P	334.05	

Part Number	Original & Biaxial	Keymark
1014608-S	317.55	
10400 CUT J		
10400 CUT T		
104001-P	277.11	
104001-S	260.61	
104207-P	219.07	
104207-S	202.57	
104207A-P	219.07	
104207A-S	202.57	
104407HA-P		
104407HA-S		
105100 C		
105100 G		
105100 S		
105100-P	219.07	158.34
105100-S	202.57	141.84
105104-P	388.8	
105104-S	372.3	
105200 C		
105200 S		
105200-P	297.92	215.5
105200-S	281.42	199
105300-P	305.58	223.16
105300-S	289.08	206.66
105400 C		
105400 M		
105400 S		
105400-P	313.25	230.82
105400-S	296.75	214.32
105500 C		
105500 S		
105500-P	331.86	249.44
105500-S	315.36	232.94
105600-P	348.29	
105600-S	331.79	
105700 C		
105700-P	369.09	286.67

Part Number	Original & Biaxial	Keymark
105700-S	352.59	270.17
105800-P	481.88	
105800-S	465.38	
105900-P	421.65	
105900-S	405.15	
105901-P	541	
105901-S	524.5	
105904-P	357.05	
105904-S	340.55	
1065140-P	198.27	129.92
1065140-S	181.77	113.42
10651S4-P	224.58	156.23
10651S4-S	208.08	139.73
1065244-P	209.22	
1065244-S	192.72	
10652S4-P	221.21	148.07
10652S4-S	204.71	131.57
10661S4-P	226.59	158.24
10661S4-S	210.09	141.74
10662S4-P	227.06	153.93
10662S4-S	210.56	137.43
1075127-P	230.31	136.08
1075127-S	213.81	119.58
110018		
110092		
110A00-P		
110A00-S		
110A01-P		
110A01-S		
110A02-P		
110A02-S		
110A03-P		
110A03-S		
110A04-P	173.09	
110A04-S	156.59	
110A05-P	173.09	
110A05-S	156.59	

Part Number	Original & Biaxial	Keymark
110A06-P	184.03	
110A06-S	167.53	
110A07-P	184.03	
110A07-S	167.53	
110A08L		
110A08-P	322	
110A08-S	305.5	
110A09L		
110A09-P	351.57	
110A09-S	335.07	
110A10		
110A12		
110A14		
110A16		
110A17		
110A18		
110A1911		
110A1912		
110A1921		
110A1922		
110A1923		
110A20		
110A21		
110A22		
110A23		
11A01913		
11C281		
11C282		
11C301-P	436.98	
11C301-S	420.48	
11C302-P	436.98	
11C302-S	420.48	
11C303-P	436.98	
11C303-S	420.48	
11C304-P	436.98	
11C304-S	420.48	
11C305-P	436.98	

Part Number	Original & Biaxial	Keymark
11C305-S	420.48	
11C306-P	436.98	
11C306-S	420.48	
11C30L-P	352.43	
11C30L-S	335.93	
11C311-P	443.55	
11C311-S	427.05	
11C312-P	443.55	
11C312-S	427.05	
11C313-P	443.55	
11C313-S	427.05	
11C314-P	443.55	
11C314-S	427.05	
11C315-P	443.55	
11C315-S	427.05	
11C316-P	443.55	
11C316-S	427.05	
11C31L-P	359	
11C31L-S	342.5	
11C321-P	672.48	
11C321-S	639.48	
11C322-P	672.48	
11C322-S	639.48	
11C323-P	672.48	
11C323-S	639.48	
11C324-P	672.48	
11C324-S	639.48	
11C325-P	672.48	
11C325-S	639.48	
11C326-P	672.48	
11C326-S	639.48	
11C32L-P	587.93	
11C32L-S	554.93	
11C341-P	429.31	
11C341-S	412.81	
11C342-P	429.31	
11C342-S	412.81	

Part Number	Original & Biaxial	Keymark
11C391-P	429.31	
11C391-S	412.81	
11C392-P	429.31	
11C392-S	412.81	
11C401	228	
11C402	228	
11C405	228	
11C406	228	
11C421	279	
11C422	279	
11C425	279	
11C426	279	
11C601 C		
11C601 S		
11C601-P	323.1	
11C601-S	306.6	
11C602 C		
11C602 S		
11C602-P	323.1	
11C602-S	306.6	
11C603 C		
11C603 S		
11C603-P	323.1	
11C603-S	306.6	
11C604 C		
11C604 S		
11C604-P	323.1	
11C604-S	306.6	
11C605 C		
11C605 S		
11C605-P	323.1	
11C605-S	306.6	
11C606 C		
11C606 S		
11C606-P	323.1	
11C606-S	306.6	
11C60L C		

Part Number	Original & Biaxial	Keymark
11C60L S		
11C60L-P	238.55	
11C60L-S	222.05	
11C611-P	329.67	
11C611-S	313.17	
11C612-P	329.67	
11C612-S	313.17	
11C613-P	329.67	
11C613-S	313.17	
11C614-P	329.67	
11C614-S	313.17	
11C615-P	329.67	
11C615-S	313.17	
11C616-P	329.67	
11C616-S	313.17	
11C61L-P	245.12	
11C61L-S	228.62	
11C621 S		
11C621-P	442.53	
11C621-S	409.53	
11C622 S		
11C622-P	442.53	
11C622-S	409.53	
11C623 S		
11C623-P	442.53	
11C623-S	409.53	
11C624 S		
11C624-P	442.53	
11C624-S	409.53	
11C625 S		
11C625-P	442.53	
11C625-S	409.53	
11C626 S		
11C626-P	442.53	
11C626-S	409.53	
11C62L S		
11C62L-P	357.98	

Part Number	Original & Biaxial	Keymark
11C62L-S	324.98	
11C631-P	500.56	
11C631-S	467.56	
11C631T-P	500.56	
11C631T-S	467.56	
11C632-P	500.56	
11C632-S	467.56	
11C632T-P	500.56	
11C632T-S	467.56	
11C633-P	500.56	
11C633-S	467.56	
11C633T-P	500.56	
11C633T-S	467.56	
11C634-P	500.56	
11C634-S	467.56	
11C634T-P	500.56	
11C634T-S	467.56	
11C635-P	500.56	
11C635-S	467.56	
11C635T-P	500.56	
11C635T-S	467.56	
11C636-P	500.56	
11C636-S	467.56	
11C636T-P	500.56	
11C636T-S	467.56	
11C63L-P	416.01	
11C63L-S	383.01	
11C63LT-P	416.01	
11C63LT-S	383.01	
11C641-P	316.53	
11C641-S	300.03	
11C642-P	316.53	
11C642-S	300.03	
11C691-P	316.53	
11C691-S	300.03	
11C692-P	316.53	
11C692-S	300.03	

Part Number	Original & Biaxial	Keymark
11C701		226.66
11C702		226.66
11C703		226.66
11C704		226.66
11C705		226.66
11C706		226.66
11C711		225
11C712		225
11C713		225
11C714		225
11C715	225	
11C716		225
11C721	264	
11C722	264	
11C723	264	
11C724	264	
11C725	264	
11C726	264	
11C801-P		337.33
11C801-S		320.83
11C802-P		337.33
11C802-S		320.83
11C803-P		337.33
11C803-S		320.83
11C804-P		337.33
11C804-S		320.83
11C805-P		337.33
11C805-S		320.83
11C806-P		337.33
11C806-S		320.83
11C811-P		343.9
11C811-S		327.4
11C812-P		343.9
11C812-S		327.4
11C813-P		343.9
11C813-S		327.4
11C814-P		343.9

Part Number	Original & Biaxial	Keymark
11C814-S		327.4
11C815-P		343.9
11C815-S		327.4
11C816-P		343.9
11C816-S		327.4
11C821-P		487.43
11C821-S		454.43
11C822-P		487.43
11C822-S		454.43
11C823-P		487.43
11C823-S		454.43
11C824-P		487.43
11C824-S		454.43
11C825-P		487.43
11C825-S		454.43
11C826-P		487.43
11C826-S		454.43
11C841-P		330.76
11C841-S		314.26
11C842-P		330.76
11C842-S		314.26
11C891-P		330.76
11C891-S		314.26
11C892-P		330.76
11C892-S		314.26
11C901-P		337.33
11C901-S		320.83
11C902-P		337.33
11C902-S		320.83
11C903-P		337.33
11C903-S		320.83
11C904-P		337.33
11C904-S		320.83
11C905-P		337.33
11C905-S		320.83
11C906-P		337.33
11C906-S		320.83

Part Number	Original & Biaxial	Keymark
11C911-P		343.9
11C911-S		327.4
11C912-P		343.9
11C912-S		327.4
11C913-P		343.9
11C913-S		327.4
11C914-P		343.9
11C914-S		327.4
11C915-P		343.9
11C915-S		327.4
11C916-P		343.9
11C916-S		327.4
11C921-P		487.43
11C921-S		454.43
11C922-P		487.43
11C922-S		454.43
11C923-P		487.43
11C923-S		454.43
11C924-P		487.43
11C924-S		454.43
11C925-P		487.43
11C925-S		454.43
11C926-P		487.43
11C926-S		454.43
11C941-P		330.76
11C941-S		314.26
11C942-P		330.76
11C942-S		314.26
11C991-P		330.76
11C991-S		314.26
11C992-P		330.76
11C992-S		314.26
11R503-P	323.1	
11R503-S	306.6	
11R504-P	323.1	
11R504-S	306.6	
11R523-P	442.53	

Part Number	Original & Biaxial	Keymark
11R523-S	409.53	
11R524-P	442.53	
11R524-S	409.53	
11R533-P	500.56	
11R533-S	467.56	
11R534-P	500.56	
11R534-S	467.56	
11R57L	225.11	
11R5DL	300.11	
11R601 C		
11R601 S		
11R602 C		
11R602 S		
11R603 C		
11R603 S		
11R603-P	323.1	
11R603-S	306.6	
11R604 C		
11R604 S		
11R604-P	323.1	
11R604-S	306.6	
11R605 C		
11R605 S		
11R606 C		
11R606 S		
11R60L C		
11R60L S		
11R621 S		
11R622 S		
11R623 S		
11R623-P	442.53	
11R623-S	409.53	
11R624 S		
11R624-P	442.53	
11R624-S	409.53	
11R625 S		
11R626 S		

Part Number	Original & Biaxial	Keymark
11R62L S		
11R633-P	500.56	
11R633-S	467.56	
11R634-P	500.56	
11R634-S	467.56	
11R67L	225.11	
11R6DL	300.11	
1200100 T		
12001002 -	79.28	
12001006 W	79.28	
1200500 T		
12005002 -	79.28	
12005006 W	79.28	
1202000 T		
12020002 -	79.28	
12020006 W	79.28	
1202100 T		
12021002 -	79.28	
12021006 W	79.28	
1202800 T		
12028002 -	79.28	
12028006 W	79.28	
1202900		
12029002 -	79.28	
12029006 W	79.28	
1203000 T		
12030002 -	79.28	
12030006 W	79.28	
12126002 -	79.28	
12126156 W	79.28	
1212633 T		
1228600		
1228800	77.85	
1236200		
1238900 J		
1238900 P		
1239000 J		

Part Number	Original & Biaxial	Keymark
1239000 P		
1239100 J		
1239100 P		
1243400		
1251200 J		
1251200 P		
1251300 J		
1251300 P		
1251460 J		
1251472 P		
12801006 H		
12814006 H		
12816006 H		
12828006 H		
12829006 H		
12832716 H		
12835006 H		
12836006 H		
12837006 H		
12847006 H		
13327		
13346		
13375		
2000400-P	191.7	
2000400-S	175.2	
2000700-P	191.7	125.27
2000700-S	175.2	108.77
2000800-P	191.7	
2000800-S	175.2	
2000827-P	191.7	
2000827-S	175.2	
20008S4-P	197.75	
20008S4-S	181.25	
2000900 S		
2000900-P	191.7	125.27
2000900-S	175.2	108.77
2000938 S		

Part Number	Original & Biaxial	Keymark
-------------	--------------------	---------

2000938-P	206.01	
2000938-S	189.51	
2000956-P		
2000956-S		
20009S4 M		
20009S4 S		
20009S4-P	197.75	131.32
20009S4-S	181.25	114.82
2001200-P	191.7	
2001200-S	175.2	
2001300-P	191.7	
2001300-S	175.2	
2001400-P	191.7	
2001400-S	175.2	
200155-P		159.51
200155-S		143.01
2001600 G		
2001600-P	139.14	72.71
2001600-S	122.64	56.21
2001700-P	191.7	
2001700-S	175.2	
2001851-P	191.7	
2001851-S	175.2	
200500 S		
200500-P	191.7	125.27
200500-S	175.2	108.77
200503 C		
200503 G		
200503 M		
200503 S		
200503-P	191.7	125.27
200503-S	175.2	108.77
200700-P	191.7	
200700-S	175.2	
200701-P	191.7	
200701-S	175.2	
200801-P	192.79	

Part Number	Original & Biaxial	Keymark
200801-S	176.29	
200802-P	188.41	
200802-S	171.91	
200807-P	192.79	
200807-S	176.29	
200808-P	192.79	
200808-S	176.29	
200901 C		
200901 S		
200901-P	192.79	126.36
200901-S	176.29	109.86
200902 C		
200902 S		
200902-P	192.79	126.36
200902-S	176.29	109.86
200903-P	192.79	126.36
200903-S	176.29	109.86
200904 C		
200904-P	192.79	126.36
200904-S	176.29	109.86
200907-P	192.79	126.36
200907-S	176.29	109.86
201006 G		
201006-P		
201006-S		
20110039-P	191.7	
20110039-S	175.2	
20112B1 G		
2020000 C		
2020000 G		
2020000 M		
2020000 S		
2020000-P	191.7	125.27
2020000-S	175.2	108.77
2020049 C		
2020049 G		
2020049 M		

Part Number	Original & Biaxial	Keymark
2020049 S		
2020049-P	191.7	125.27
2020049-S	175.2	108.77
2020051 G		
2020051-P	191.7	125.27
2020051-S	175.2	108.77
2020052 C		
2020052 S		
2020052-P	191.7	125.27
2020052-S	175.2	108.77
2020053 S		
2020053-P	191.7	125.27
2020053-S	175.2	108.77
2020054-P	191.7	125.27
2020054-S	175.2	108.77
2020058-P	191.7	125.27
2020058-S	175.2	108.77
2020068-P	191.7	125.27
2020068-S	175.2	108.77
2020070 C		
2020070-P	191.7	125.27
2020070-S	175.2	108.77
2020071-P	191.7	125.27
2020071-S	175.2	108.77
2020072-P	191.7	125.27
2020072-S	175.2	108.77
2020073 C		
2020073 G		
2020073 M		
2020073 S		
2020073-P	191.7	125.27
2020073-S	175.2	108.77
2020074 C		
2020074 M		
2020074 S		
2020074-P	191.7	125.27
2020074-S	175.2	108.77

Part Number	Original & Biaxial	Keymark
2020078 C		
2020078 S		
2020078-P	191.7	125.27
2020078-S	175.2	108.77
2020097 G		
2020097 M		
2020097 S		
2020097-P	194.01	127.58
2020097-S	177.51	111.08
20200A1 C		
20200A1 G		
20200A1 M		
20200A1 S		
20200A1-P	194.01	127.58
20200A1-S	177.51	111.08
20200F1 G		
20200F1 M		
20200F1 S		
20200F1-P	194.01	127.58
20200F1-S	177.51	111.08
20200H1-P	202.89	136.46
20200H1-S	186.39	119.96
20200L1 C		
20200L1 G		
20200L1 S		
20200L1-P	194.01	127.58
20200L1-S	177.51	111.08
20200S1 C		
20200S1 G		
20200S1 M		
20200S1 S		
20200S1-P	194.01	127.58
20200S1-S	177.51	111.08
20200V0 C		
20200V0 G		
20200V0 M		
20200V0 S		

Part Number	Original & Biaxial	Keymark
20200V0-P	191.7	125.27
20200V0-S	175.2	108.77
20200V1 C		
20200V1 G		
20200V1 M		
20200V1 S		
20200V1-P	191.7	125.27
20200V1-S	175.2	108.77
20200V2 C		
20200V2 G		
20200V2 S		
20200V2-P	191.7	125.27
20200V2-S	175.2	108.77
20200V3 G		
20200V3 M		
20200V3 S		
20200V3-P	191.7	125.27
20200V3-S	175.2	108.77
20200V9 C		
20200V9 G		
20200V9 S		
20200V9-P	191.7	125.27
20200V9-S	175.2	108.77
2020149-P	191.7	
2020149-S	175.2	
2020169-P	191.7	125.27
2020169-S	175.2	108.77
2020170-P	191.7	125.27
2020170-S	175.2	108.77
2020173 M		
2020173-P	191.7	125.27
2020173-S	175.2	108.77
2020249 C		
2020249-P	191.7	125.27
2020249-S	175.2	108.77
20202V9 C		
20202V9-P		

Part Number	Original & Biaxial	Keymark
20202V9-S		
2020349-P	191.7	125.27
2020349-S	175.2	108.77
2020575-P	191.7	125.27
2020575-S	175.2	108.77
2020777-P	191.7	125.27
2020777-S	175.2	108.77
2021173 C		
20211730 M		
20211730 S		
20211730-P	191.7	125.27
20211730-S	175.2	108.77
203000-P	191.7	125.27
203000-S	175.2	108.77
205003-P	192.79	125.27
205003-S	176.29	109.86
205004-P	191.7	125.27
205004-S	175.2	108.77
205005 C		
205005-P	191.7	125.27
205005-S	175.2	108.77
205006-P	191.7	125.27
205006-S	175.2	108.77
205008-P	191.7	125.27
205008-S	175.2	108.77
2051027-P	191.7	125.27
2051027-S	175.2	108.77
2051100-P	191.7	
2051100-S	175.2	
2051200-P	191.7	
2051200-S	175.2	
2051500-P	191.7	125.27
2051500-S	175.2	108.77
2052000-P	191.7	
2052000-S	175.2	
206005-P	192.79	
206005-S	176.29	

Part Number	Original & Biaxial	Keymark
206100-P	191.7	
206100-S	175.2	
207001-P	192.79	
207001-S	176.29	
208005-P	191.7	125.27
208005-S	175.2	108.77
208006 S		
208006-P	191.7	125.27
208006-S	175.2	108.77
208007-P	191.7	125.27
208007-S	175.2	108.77
208008-P	191.7	125.27
208008-S	175.2	108.77
2080147 M		
2080147 S		
2080147-P	192.79	126.36
2080147-S	176.29	109.86
2080148 S		
2080148-P	192.79	
2080148-S	176.29	
2080161-P		
2080161-S		
2080700-P	191.7	125.27
2080700-S	175.2	108.77
210503-P		120.42
210503-S		103.92
23010168-P	130.08	
23010168-S	113.58	
2301016-P	169.8	
2301016-S	153.3	
2303016A-S	196	
230301S G		
2304005	238.78	
2304005-S	222.28	
2304006	238.78	
2304006-S	222.28	
2304015	182.91	

Part Number	Original & Biaxial	Keymark
2304015-S	166.41	
2304016	182.91	
2304016-S	166.41	
2304025	244.16	
2304025-S	211.16	
2304026	244.16	
2304026-S	211.16	
2305016	176.37	
2306016	176.37	
2309016	260.69	
2305016-S	159.87	
230501S G		
2306016-S	159.87	
230601S G		
23070165	198.27	
23070165-S	181.77	
23080166	202.65	
23080166-S	186.15	
230801S		
2309016-S	244.19	
2310016	260.69	
2310016-S	244.19	
23130 CUT		
2313005 X00	212.5	
2313005 X00-S	196	
2313006 X00	222.96	
2313006 X00-S	206.46	
2313015 800	184.09	
2313015 800-S	167.59	
2313015 801	188.34	
2313015 801-S	171.84	
2313016 800	186.32	
2313016 800-S	169.82	
2313016 801	190.57	
2313016 801-S	174.07	
2313025 X00	216.4	
2313025 X00-S	183.4	

Part Number	Original & Biaxial	Keymark
-------------	--------------------	---------

2313025 X01	220.65	
2313025 X01-S	187.65	
2313025 X02-S	191.9	
2313025 X11	224.9	
2313025 X11-S	191.9	
2313025 X12	229.15	
2313025 X12-S	196.15	
2313026 X00	230.4	
2313026 X00-S	197.4	
2313026 X01	234.65	
2313026 X01-S	201.65	
2313026 X02	238.9	
2313026 X02-S	205.9	
2313026 X12	243.15	
2313026 X12-S	210.15	
2313035 X00	212.5	
2313036 X00	222.96	
2313036 X00-S	206.46	
2313045 X00	212.5	
2313045 X00-S	196	
2313046 X00	0	
2313046 X00-S	206.46	
2313055 X00	212.5	
2313055 X00-S	196	
2313056 X00	222.96	
2313056 X00-S	206.46	
2313065 X00	212.5	
2313065 X00-S	196	
2313066 X00	222.96	
2313066 X00-S	206.46	
2314003-P	124.58	
2314003-S	108.08	
2315005-P	141.33	
2315005-S	124.83	
2316004-P	141.33	
2316004-S	124.83	
2320016-P	169.8	

Part Number	Original & Biaxial	Keymark
2320016-S	153.3	
2322015 300	73.44	
2322015 301	77.69	
2322016 300	80.08	
2322016 301	84.33	
23220X5 300	69.04	
2323005 X00	212.5	
2323006 X00	222.96	
2323025 X00	230.4	
2323026 X00	244.63	
310100A-P	209.22	141.06
310100A-S	192.72	124.56
310100-P	209.22	141.06
310100-S	192.72	124.56
310101A-P	340.62	
310101A-S	324.12	
310101-P	340.62	
310101-S	324.12	
310102H-P	351.57	
310102H-S	335.07	
310102V-P	351.57	
310102V-S	335.07	
310104H-P	351.57	
310104H-S	335.07	
310104V-P	351.57	
310104V-S	335.07	
320100-P	339.52	
320100-S	323.02	
320101-P	208.13	
320101-S	191.63	
320101H-P	208.13	
320101H-S	191.63	
320200-P	340.62	
320200-S	324.12	
320200B-P	485.97	
320200B-S	469.47	
320201CC BI R1	309.22	

Part Number	Original & Biaxial	Keymark
-------------	--------------------	---------

320201H-P	209.22	
320201H-S	192.72	
320201-P	209.22	
320201-S	192.72	
320202-P	184.03	
320202-S	167.53	
320300H-P	329.67	
320300H-S	313.17	
320300V-P	329.67	
320300V-S	313.17	
320400H-P	351.57	
320400H-S	335.07	
320400V-P	351.57	
320400V-S	335.07	
320405H-P	373.47	
320405H-S	356.97	
320600-P	317.63	
320600-S	301.13	
320700-P	352.67	
320700-S	336.17	
321200-P	343.91	
321200-S	327.41	
321201-P	212.5	
321201-S	196	
321350-P	392.08	
321350-S	375.58	
322201-P	217.98	146.72
322201-S	201.48	130.22
322301-P	209.22	149.58
322301-S	192.72	133.08
322401-P	209.22	149.58
322401-S	192.72	133.08
322801-P		161.13
322801-S		145.13
324201-P	209.22	
324201-S	192.72	
325200-P	566.19	

Part Number	Original & Biaxial	Keymark
325200-S	549.69	
325375	383	
325400-P	588.09	
325400-S	571.59	
325500-P	604.51	
325500-S	588.01	
325600-P	649.41	
325600-S	632.91	
325700-P	676.78	
325700-S	660.28	
325775	431	
33600006-P		101.47
33600006-S		84.97
33600007 K-P		101.47
33600007 K-S		84.97
33602012-P		156.66
33602012-S		140.16
33602013 K-P		156.66
33602013 K-S		140.16
33602032-P		160.91
33602032-S		144.41
33602033 K-P		160.91
33602033 K-S		144.41
33602042-P		160.91
33602042-S		144.41
33602043 K-P		160.91
33602043 K-S		144.41
33602052-P		156.66
33602052-S		140.16
33602062-P		156.66
33602062-S		140.16
33602063 K-P		156.66
33602063 K-S		140.16
33700006-P		101.47
33700006-S		84.97
33700007 K-P		101.47
33700007 K-S		84.97

Part Number	Original & Biaxial	Keymark
3370000S-P		108.7
3370000S-S		92.2
33702022-P		156.66
33702022-S		140.16
33702023 K-P		156.66
33702023 K-S		140.16
33702042-P		160.91
33702042-S		144.41
33702043 K-P		160.91
33702043 K-S		144.41
337020B2-P		160.91
337020B2-S		144.41
337020C2-P		156.66
337020C2-S		140.16
337020E2-P		156.66
337020E2-S		140.16
490078-P	231.12	
490078-S	214.62	
490079-P	231.12	
490079-S	214.62	
490214-P	211.41	
490214-S	194.91	
490258-P	239.88	
490258-S	223.38	
500020-P	130.38	
500020-S	113.88	
5002201-P	465.45	
5002201-S	448.95	
5002211-P	465.45	
5002211-S	448.95	
5003201-P	465.45	
5003201-S	448.95	
5003211-P	465.45	
5003211-S	448.95	
5008201-P	439.17	
5008201-S	422.67	
5008211-P	439.17	

Part Number	Original & Biaxial	Keymark
5008211-S	422.67	
5009201-P	439.17	
5009201-S	422.67	
5009211-P	439.17	
5009211-S	422.67	
510600-P	154.47	135.43
510600-S	137.97	118.93
526001-P	228.93	
526001-S	212.43	
526011-P	228.93	
526011-S	212.43	
526101-P	228.93	
526101-S	212.43	
526111-P	228.93	
526111-S	212.43	
526201-P	228.93	
526201-S	212.43	
526211-P	228.93	
526211-S	212.43	
526301-P	228.93	
526301-S	212.43	
526311-P	228.93	
526311-S	212.43	
5431500-P		204.16
5431500-S		187.66
54315R0-P		204.16
54315R0-S		187.66
5431F00-P		210.72
5431F00-S		194.22
5431FR0-P		210.72
5431FR0-S		194.22
5433500-P		204.16
5433500-S		187.66
54335R0-P		204.16
54335R0-S		187.66
5433F00-P		210.72
5433F00-S		194.22

Part Number	Original & Biaxial	Keymark
5433FR0-P		210.72
5433FR0-S		194.22
5451500-P	236.59	217.29
5451500-S	220.09	200.79
54515R0-P	236.59	0
54515R0-S	220.09	200.79
5451F00-P	240.97	221.68
5451F00-S	224.47	205.18
5451FR0-P	240.97	221.68
5451FR0-S	224.47	205.18
5452500-P	267.25	247.96
5452500-S	250.75	231.46
54525R0-P	267.25	247.96
54525R0-S	250.75	231.46
5461500-P	324.19	
5461500-S	307.69	
54615R0-P	324.19	
54615R0-S	307.69	
5461F00-P	332.95	
5461F00-S	316.45	
5461FR0-P	332.95	
5461FR0-S	316.45	
5471500-P	273.82	254.53
5471500-S	257.32	238.03
54715R0-P	273.82	254.53
54715R0-S	257.32	238.03
5471F00-P	280.39	261.1
5471F00-S	263.89	244.59
5471FR0-P	280.39	261.1
5471FR0-S	263.89	244.59
5472500-P	327.48	308.18
5472500-S	310.98	291.68
54725R0-P	327.48	308.18
54725R0-S	310.98	291.68
600250T-P	141.78	
600250T-S	112.78	
600350T KIT-P	152.54	

Part Number	Original & Biaxial	Keymark
600350T KIT-S	123.55	
600350T-P	141.78	
600350T-S	112.78	
600450T-P	141.78	
600450T-S	112.78	
600550T-P	138.17	
600550T-S	109.17	
600650T KIT-P	152.54	
600650T KIT-S	123.55	
600650T-P	141.78	
600650T-S	112.78	
600750T-P	138.17	
600750T-S	109.17	
600850T-P	138.17	
600850T-S	109.17	
600950T-P	141.78	
600950T-S	112.78	
601150T KIT-P	152.54	
601150T KIT-S	123.55	
601150T-P	141.78	
601150T-S	112.78	
601250T-P	126.02	
601250T-S	97.02	
601251T-P	126.02	
601251T-S	97.02	
601450T KIT-P	158.02	
601450T KIT-S	129.02	
601450T-P	147.26	
601450T-S	118.26	
601452T-P	151.64	
601452T-S	122.64	
60300 CUT W 219	112.44	
607155XT-P	161.5	
607155XT-S	132.5	
607255XT-P	161.5	
607255XT-S	132.5	
607355XT-P	161.5	

Part Number	Original & Biaxial	Keymark
607355XT-S	132.5	
607455XT-P	151.19	
607455XT-S	134.69	
607555XT-P	151.19	
607555XT-S	134.69	
6210555T-P	176.37	
6210555T-S	159.87	
6211555T-P	209.68	
6211555T-S	180.68	
6212555T-P	188.87	
6212555T-S	159.87	
6221554T-P	208.5	
6221554T-S	179.58	
6221557T-P	208.5	
6221557T-S	179.58	
6261557T-P	243.62	
6261557T-S	214.62	
640155CT-P	126.56	
640155CT-S	97.56	
640155T-P	126.56	
640155T-S	97.56	
640250T-P	147.26	
640250T-S	118.26	
640251T-P	147.26	
640251T-S	118.26	
640550AT-P	166.97	
640550AT-S	137.97	
640550FT-P	166.97	
640550FT-S	137.97	
640550T-P	166.97	
640550T-S	137.97	
640750ET-P	129.08	
640750ET-S	100.08	
640750GT-P	129.08	
640750GT-S	100.08	
640950T-P	139.59	
640950T-S	110.59	

Part Number	Original & Biaxial	Keymark
-------------	--------------------	---------

640952T-P	139.59	
640952T-S	110.59	
641050T-P	180.11	
641050T-S	151.11	
641051T-P	180.11	
641051T-S	151.11	
652150T 011-P	175.73	
652150T 011-S	146.73	
652150T 012-P	175.73	
652150T 012-S	146.73	
652150T 021-P	175.73	
652150T 021-S	146.73	
6522560T 121-P	171.35	
6522560T 121-S	142.35	
6522560T 122-P	171.35	
6522560T 122-S	142.35	
6522560T 132-P	171.35	
6522560T 132-S	142.35	
6522560T 133-P	171.35	
6522560T 133-S	142.35	
6522560T 134-P	171.35	
6522560T 134-S	142.35	
6522560T 221-P	171.35	
6522560T 221-S	142.35	
652650T 101-P	286.32	
652650T 101-S	257.32	
652650T 102-P	286.32	
652650T 102-S	257.32	
652650T 111-P	286.32	
652650T 111-S	257.32	
652650T 131-P	286.32	
652650T 131-S	257.32	
652650T 132-P	286.32	
652650T 132-S	257.32	
652650T 133-P	286.32	
652650T 133-S	257.32	
66391-P	112.88	

Part Number	Original & Biaxial	Keymark
-------------	--------------------	---------

66391-S	83.88	
66418-P	133.46	
66418-S	104.46	
960357-P	150.54	
960357-S	121.55	
960358-P	150.54	
960358-S	121.55	
960590 W 26-S6-S	100.87	
2020373-P	191.7	125.27
2020373-S	175.2	108.77
5292000-P	259.59	240.55
5292000-S	243.09	224.05
5292001-P	259.59	240.55
5292001-S	243.09	224.05
5292100-P	259.59	240.55
5292100-S	243.09	224.05
5292101-P	259.59	240.55
5292101-S	243.09	224.05

The ASSA ABLOY Group is the global leader in access solutions. Every day, we help billions of people experience a more open world.

ASSA ABLOY Opening Solutions leads the development within door openings and products for access solutions in homes, businesses and institutions. Our offering includes doors, frames, door and window hardware, locks, perimeter fencing, access control and service.



medeco[®]

ASSA ABLOY

MEDECO USA

3625 Alleghany Drive | Salem, Virginia 24153-0330
Customer Service 1.877.633.3261

MEDECO CANADA

160 Four Valley Drive | Vaughan, ON L4K 4T9 CANADA
Customer Service 1.888.633.3264



facebook.com/medecolocks



youtube.com/medecolocks



newsletter sign up: medeco.com



linkedin.com/company/medecolocks/