



MARKSUSA

2024/2025

Price List

Mortise Locksets

**Cylindrical, Tubular & Electronic
Access Control Locksets**

Exit Devices



GENERAL INFORMATION

TABLE OF CONTENTS

Terms & Conditions	5
Required Information	6
Backset	6
Door Thickness	6
Handing	6
Mounts & Displays	6

MORTISE LOCKSET PRICE LIST

Mortise Lock Trim Information	7
Leverset/Knobset Trim	7
How To Order Mortise Locksets	8
Option Codes	9-10
Plate Designs	11-20
Classic - CL	11-12
Capitol - CP	13-14
Crown - CR	15-16
Drake - DR	17-18
New Yorker - NY	19-20
Rose Designs	21-22
Rose with Ring - RR	21-22
Plain Rose - RW	21-22
Small Rose with Ring - RQ	21-22
Small Rose - RS	21-22
Square Rose (Wrought)- RX	21-22
Square Rose (Forged) - RK	21-22
Square Rose with Corner Screws- RL	21-22
Ornamental Iron	23-24
Series 21 Unilock™	23
Series 22	23
Series 9215 Unilock™	23
Series 9225	23
THINLINE® Series 2750	23
Knob & Lever Kits	24
Accessories	24
Cylinders	24
Mortise Parts & Trim	25-36
Mortise Lock Bodies Series 5 & 55	25
Mortise Lock Bodies Series 6 & 8	26
Mortise Lock Bodies Series 7 & 9	27
Mortise Deadlocks Series 31, 2, 3, 5 & 55	28
Mortise Lockset Functions	29-30
Mortise Lock Parts: Knob/Lever Rose Kits	31
Mortise Lock Parts: Collars & Turnpieces, Strikes, Spindles	32
Mortise Lock Parts: Indicators	33
Trim Lock Parts: Plate/Rose Design	34-35
Trim Lock Parts: Knob/Lever Design	36

CYLINDRICAL & TUBULAR LOCKSET PRICE LIST

How To Order Cylindrical Locksets	37
Series	37
Cylindrical Functions	37
Finishes	37
Options	37
Cylindrical Locksets	38-40
10 Line Grade 2 Cylindrical Knobsets	38
95 Line Grade 1 Cylindrical Survivor Series Leversets	39
75 Line Grade 2 Cylindrical Survivor Series Leversets	40
Cylindrical Lock Accessories	41-42
Latches, Strikes, Spacer Rings, Etc.	41
Cylinders, Cylindrical Lock Tailpieces, Cylindrical IC Core Tailpieces	42
How to order example for Cylindrical Lock Cylinders & Tailpieces	42
Cylindrical Knob/Lever Functions	43
How To Order Tubular Lockset	44
Series	44
Roses44	
Knob/Lever	44
Tubular Function	44
Finishes	44
Options	44
Tubular Knob & Lever Functions	44
Rose Designs	45
Rose with Ring - RR	45
Plain Rose - RW	45
Small Rose with Ring - RQ	45
Small Rose - RS	45
Square Rose (Wrought)- RX	45
Square Rose (Forged) - RK	45
Square Rose with Corner Screws- RL	45
60 Series Stainless Tubular Locksets	46
160 Series Copa Lever	46
260 Series Commerce Lever	46
360 Series Maxwell Lever	46
Tubular Lockset Accessories	47
Strikes, Latches, Support Housing	47
Turnpieces	47
Latches & Cylindrical Cartridge	47
How To Order For Defender Locksets	48
Series	48
Deadbolt/Deadlatch Functions	48
Finishes	48
Options	48
Defender Series Tubular Deadbolts & Cylindrical Cartridge Deadlatch	49
130 Series Defender Tubular Deadbolts	49
145 Series Grade 1 Defender Cylindrical Cartridge Deadlatches	49
Defender Series Accessories	50
Strikes, Latches & Spacers	50
Latches & Cylindrical Cartridge	50
Tailpieces & Cylinders	50

ELECTRIFIED LOCKSETS AND BASIC ACCESS CONTROL

i-Qwik Electronic Access Control Locksets	51-53
i-Qwik LITE Series Electronic Access Control & How To Order Example	51
i-Qwik LITE Series Options	52
i-Qwik Series Accessories, Tailpieces & Cams	53
Request To Exit (REX) Leversets & Electrified Locksets	54-55
Request To Exit (REX) Cylindrical Grade 1 Leversets (EA195, EA295, EA395 & EA495)	54
How To Order Example For REX Leversets	54
195, 295 & 495 Series Grade 1 Electrified Cylindrical Leversets	55
5 Series Grade 1 Electrified Mortise Lockset	55

WOVEN WIRE LOCKSETS

Gate Locks	56
Swinging Gate Locks	56
Sliding Gate Locks	56
Parts.....	56

CUSTOM AND SPECIALTY LOCKSETS

Housing Authority	57
Series HA113 Housing Authority Mortise Lockset	57
School Lockdown	58-60
Series LA318GJ Maximum Security Mortise Lockset	58
Series BE101 & LA118	59
Specialty lokdown	60
Behavioral Life Safety	61-65
Series 195BH D-Lig Slide Cylindrical Lockset	61
Series 5BH D-Lig Slide Mortise Lockset	62
Series 195SS Institutional Life Safety Cylindrical Lever Lockset	63
Series 5SS19 Institutional Life Safety Mortise Lever Locksets	64
Series 31SS55 Institutional Life Safety Mortise Deadlock	65
Hospital Locksets	66
Series 180PD Cylindrical Push/Pull Paddlelocks	66
Series 5PD & 55PD Mortise Push/Pull Paddlelocks	66

HI-SECURITY™

HI-SECURITY™ Cylinders	69
Security-Mate™ Cylinders, Special Application Cylinders	70
How To Order HI-SECURITY™ Cylinders and Keys	71
Keys, Cams & Tailpieces	72
Parts List	73

X-IT™ PANIC EXIT DEVICES

Series M9900 Exit Device - Rim Mount	74
Series M9900 VR Exit Device - Surface Vertical Rod	74
Series M9900 Exterior Trim	75
Series M8800 Exit Device.....	75
Series M195 Exterior Trim	76
Series M99 Night Latch Trim	76
Electric Latch Retraction with Simultaneous Dogging	77
Exit Alarm	77
Electric Dogging	78
Delayed Egress	78
Series M99LD School Lockdown Exit Device with Trim	79
M9900 LITE	79

ArchiTech™ SERIES NETWORK LOCKS

ArchiTech™ Series Network Locks	80
Electronic options	81
ArchiTech™ Cylindrical Locks	82
Price Builder	82
Trim options	82
How to Order	82
ArchiTech™ Mortise Locks	83-84
Price builder	83
Trim options	83
Functions	83
How to Order	84
ArchiTech™ availability chart	84
ArchiTech™ Parts and Accessories	85
iLock® App	85

Marks USA Antimicrobial Finish: Peace of mind for your hardware application when protected against GERMS and MOLD using Stericoat AM. Marks USA antimicrobial finish is recommended for hospitals, assisted living facilities, schools and childcare facilities. **Use Code - AM**

Lifetime Mechanical Limited Warranty: MARKS USA warrants that its products are free from defects in materials and workmanship. This warranty is limited to the lifetime of the door on which our lock is installed to the original purchaser so long as they occupy the premises. In the event our product does not conform to this warranty, MARKS USA will repair or replace the product free of charge. This warranty does not cover defects or damage arising from improper installation, lack of or improper maintenance, improper storage, shipping and handling, ordinary wear and tear, misuse, abuse, accident, unauthorized service, or use with unauthorized non-MARKS products or parts. We reserve the right to make changes in materials, components or manufacturing methods. Liability under all warranties expressed or implied is limited to replacement of the defective goods. This warranty does not cover nor provide for the reimbursement or payment of incidental or consequential damages. Additionally, the company will not warrant ANSI A156.2 Grade 2 lever product installed in educational facilities and student housing. The following exclusions are Mortise Lock Trims, Exit Trims, Metro Series, Ornamental Iron, Cylinders, Key Blanks, and Parts.

2 Year Electronic Limited Warranty: MARKS USA warrants to the original purchaser that its products are free from defects in materials and workmanship so long as they occupy the premises.

In the event our product does not conform to this warranty, MARKS USA will repair or replace the product free of charge at its sole discretion. This warranty does not cover defects or damage arising from improper installation, lack of or improper maintenance, improper storage, shipping and handling, improper application or specification, ordinary wear and tear, misuse, abuse, accident, improper voltage, unauthorized service, or use with unauthorized non-MARKS products or parts. We reserve the right to make changes in materials, components or manufacturing methods. Liability under all warranties expressed or implied is limited to replacement of the defective goods. This warranty does not cover nor provide for the reimbursement or payment of incidental or consequential damages or any shipping charges related to exercising of this warranty.

TERMS & CONDITIONS:

TERMS: Net 30

FREIGHT: Prices are F.O.B. Amityville, New York. Freight allowed on shipments over \$7500 net invoice value within Continental U.S.

RETURNED GOODS: Goods may not be returned without a Returned Goods Authorization (RGA) and are subject to a restocking charge. RGA label must be on all cartons.

MINIMUM CHARGE: Orders for less than \$250 net invoice are subject to a \$25 handling charge.

MINIMUM SALES VOLUME: The company reserves the right to discontinue direct sales to any customer who does not meet the minimum annual sales requirements during any 12 month period. Minimum annual sales volume is determined on the basis of accepted orders during each applicable year. All orders are acknowledged. It is the customers responsibility to check accuracy of the acknowledgment when received.

ArchiTech, Networkx, iLock, LocDown, LifeSaver and Hi-Security are trademarks of Marks USA, a division of NAPCO Security Technologies. All other trademarks listed are properties of their respective companies.

Effective August 2024. All prices published are suggested list prices in US Dollars. Some specifications are preliminary and subject to change without prior notice. Not responsible for typographical errors.

Marks USA is a Division of Napco Security Technologies, Inc. (NASDAQ:NSSC) © Marks USA, 12.21

BACKSET - Required Information

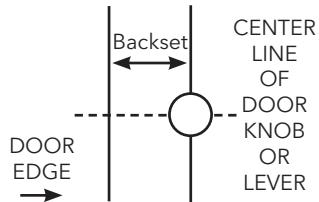

DOOR THICKNESS - Required Information

STANDARD DOOR THICKNESS RANGE:

- Mortise locksets: 1-3/4"
- Cylindrical locksets: 1-5/8" through 1-7/8"
- Ornamental locksets: 1" through 1-1/4"
- Tubular locksets: 1-3/8" through 1-3/4"
- Other door thickness: Consult factory

SPECIFY:

- Door thickness (A)
- Lock location (B)

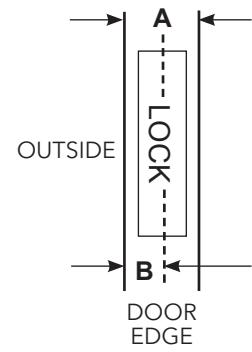

HANDING - Required Information

All locksets supplied 1/2 (LH) and 1/2 (RH) unless otherwise specified

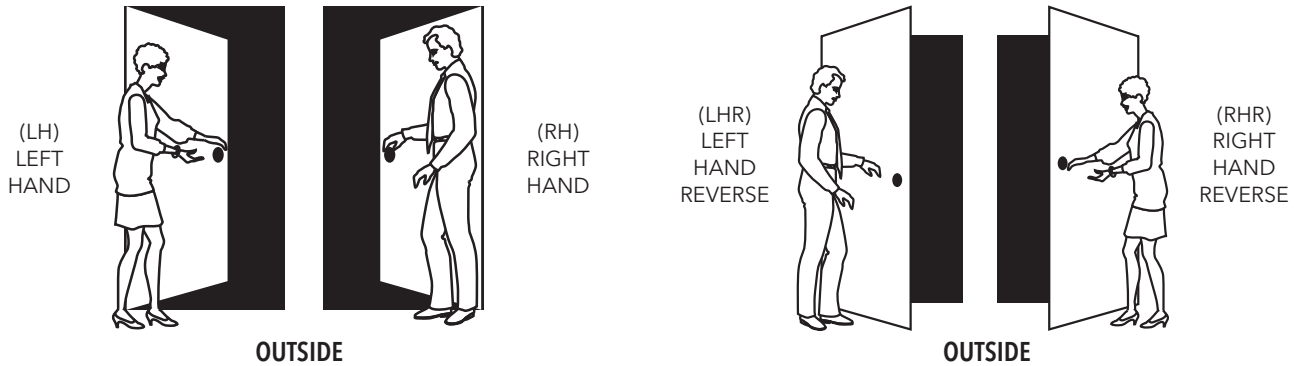

MOUNTS & DISPLAYS AVAILABLE, CONSULT FACTORY

1RW78N/26D



1RR57N/15



5DR72FD/26



5RW96LF/26D-A21



1PDN/32D



MORTISE LOCK TRIM INFORMATION

LEVERSET/KNOBSET TRIM

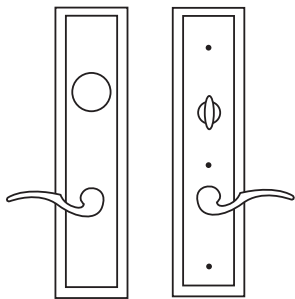

Outside Inside

ENTRANCE
Cylinder/
Turnpiece

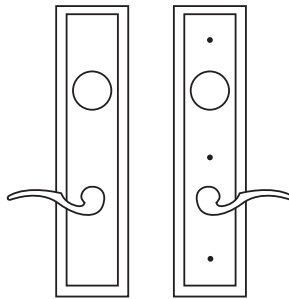

Outside Inside

ENTRANCE
Double Cylinder

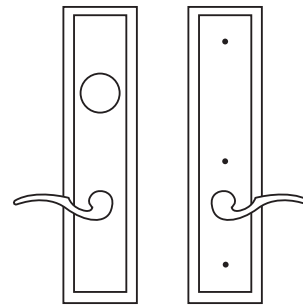

Outside Inside

OFFICE/CLASSROOM

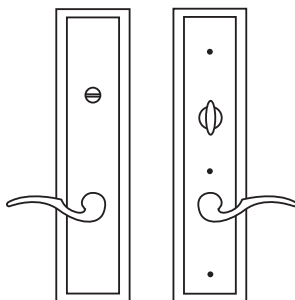

Outside Inside

PRIVACY

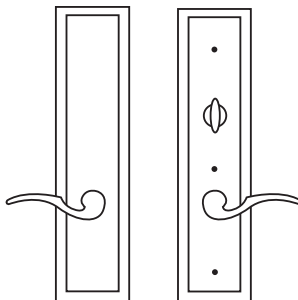

Outside Inside

EXTERIOR/PATIO

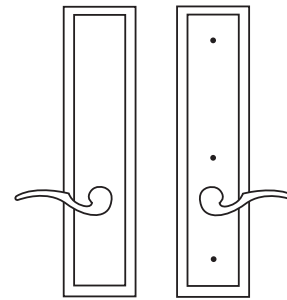

Outside Inside

DUMMY TRIM
Both sides

HOW TO ORDER MORTISE LOCKSETS

1. Select type of lockset.
2. See corresponding pages in the catalogs for information regarding this type of lock.
3. Create the part number for your lock by selecting the information from fields 1 through 6.
Please note dummy trim is Series "0".
4. Options must be listed in Alpha - Numeric order.
5. Note that if Part Number is over 15 characters, it becomes a special number with the option field *1.
(Your options will then be listed separately.)
Please note the standard (default) features of each lock - they do not need to be selected in the options section.
6. Please indicate keying detail or special instructions on each item ordered.
7. Door Templates are available by email request to marksorders@marksusa.com

How To Order Example for Mortise Locksets	7	NY	10	A	/	3	-	G3
	1. Lock Series	2. Plate/Rose Design	3. Knob/Lever Design	4. Marks Function	Slash	5. Finish	Dash	6. Options

How To Order Example for Rose Design	5	RW	92	N	/	10B	-	D1
	1. Lock Series	2. Plate/Rose Design	3. Knob/Lever Design	4. Marks Function	Slash	5. Finish	Dash	6. Options

How To Order Example for Ornamental Iron	9215	AC	/	26D	-	D4
	1. Series	2. Marks Function	Slash	3. Finish	Dash	4. Options

How To Order Example for Mortise Lock Bodies	55	JM	/	26D	-	T
	1. Series	2. Marks Function	Slash	3. Finish	Dash	4. Options

HOW TO ORDER

OPTION CODES

TRIM MODIFICATIONS	CODE	PRICE	TYPE
Tactile knob/lever, coated ext. only	A1	38	M,C,T
Emergency coinkey	A2	18	M
Tamper-proof screws	A3	10	M
Tactile knob/lever, knurled	A4	38	M,C,T
Handicapped turnpiece	A5	12	M
Hotel indicator	A6	28	M
Pinned knob	A7	23	M
Mushroom knob	A9	4	M
No logo	A10	NC	
Engraved	A11	45	M
Concealed cylinder	A12	17	M
Dummy trim sub-assembly	A13	NC	M
Coinkey w/ rose	A15	45	M
Occupancy Indicator non keyed	A17	58	M
Tactile knob/lever, coated int. & ext.	A18	78	M
Square trim	A23	19	M
Square collar	A23C	11	M
Square turnpiece	A23T	11	M
Small emergency hole	A24	NC	M
Recessed Pull (one side)	A28	45	M,C
Exposed Rose Screws	A29	NC	M,T
Engraved and Filled	A30	51	M
No inside turnpiece	A32	NC	M
Red/Green TD Occ ind no coin key	A40	114	M
A9618-Atascadero	A41	74	M
Red/Green TD Occ ind w/ coin key	A42	114	M
SKA200 Handed (All Trims)	A50	205	M
SKA200-CK Handed w/Coin key (Rose Trims Only)	A51	205	M
SKA200-TP (All Trims) Handed w/ Turn Pc	A52	205	M
SKA210 Handed (All Trims)	A53	205	M
SKA210-CK Handed w/Coin key (Rose Trims Only)	A54	205	M
SKA210-TP Handed w/ Turn Pc (Rose Trims Only)	A55	234	M
Phillip Head Screws Only	A56	NC	M,C

CYLINDER	CODE	PRICE	TYPE
SFIC Housing - 7 Pin	G1	NC	M
Special optional keyway	G2	24	M,C
Less cylinder	G3	Deduct 10	M,C
MARKS "A" keyway	G4	10	M
MARKS "C" keyway	G5	11	O
SFIC Housing w/9271 Collar - 6 Pin	G6	NC	M
IC core housing, Schlage large format (FOR MORTISE ONLY)	G7	51	M
No Cylinder, no key bypass	G8	NC	A
IC Housing, Sargent Large format	G9	38	M
Oversized recessed Cyl bore sgl or dbl less Cyl	G10	18	M
T-Turn in lieu of keyed cylinder	G12	NC	E

MOUNTS	CODE	PRICE	TYPE
M6500 Mounted mort. prep 2-3/4" bs	M1		
M6500 Mounted 2-1/2"	M2		
ME100M Mounted I Que prep	M3		
Mounted 3 hole prep	M4		
M1319 Mounted cyl/deadbolt prep	M6		
M295 Mounted Plastic	M7		
M1900 Mounted 2-1/8" prep	M8		
Mounted Panic Devices	M10		
5001PL Plastic Mortise Cover	M11		

STRIKE	CODE	PRICE	TYPE
4-7/8" ASA strike	S1	9	C,T
Straight lip strike	S2	3	M
2-3/4" "T" strike	S3	NC	C,T
3-5/8" x 1-1/4" Security strike	S4	8	T
2-1/4" Curved lip strike	S5	NC	T
4-7/8" Strikes: 1 Left / 1 Right	S6	9	INT
Strike with 1-1/2" lip	S7	11	M
Radius corner strike	S8	NC	M
4035-1 strike	S9	NC	M
1-7/8" Lip Strike	S10	NC	C,T
Sqare coner Full Lip Strike	SQ	NC	T

LOCK BODY	CODE	PRICE	TYPE
Lever override guard - outside	B1	28	M
Lever override guard - both sides	B2	40	M
Hardened pins - deadbolt	B3	12	M
Lever springs	B4	13	M
Pin and lever springs	B5	24	M
Hollow spacer	B6	12	M
8 mm hubs on square	B7	12	M
Turnpiece hub on square	B8	8	M
With deadbolt	B9	12	M
Boxed Lock Body	B10	NC	M
Lever spring outside only	B11	NC	M
Lever spring Inside only	B12	NC	M
Special Deadbolt Un Notched	B13	NC	ORN

LOCK FRONT	CODE	PRICE	TYPE
1-1/16" x 8"	Q	17	M
1-1/16" x 5-5/8"	R	18	M
1-1/16" x 7-5/8"	T	17	M
1-1/4" x 10"	U	69	M
1-1/16" x 7-3/4"	V	17	M
1" x 7-1/8"	W	NC	M
1-1/4" x 8"	X	16	M
1-1/4" x 8-5/8"	Y	69	M
1" x 8"	Z	16	M

DOOR THICKNESS	CODE	PRICE	TYPE
2"	D1*	NC	C
2-1/4"	D2*	48	C
1-3/4"	D4	NC	M
1-3/8"	D5	NC	M
Over 2-3/8 - 4" Cylindrical	D9*	409	A,C
2" - 4" Door Thickness	D14	253	M

CYLINDRICAL 18-20 WEEKS

*Prices are for centered on door. For offset, call for price.

How To Order

OPTIONS & FINISHES

TRIM CHANGES	CODE	PRICE	TYPE
Lead lined	F1	206	M,C
Large inside plate	F2	23	M
Less inside trim	F4	NC	M
Less outside trim	F5	NC	M
For 1-1/2" bore	F6	13	T
Yale/Accentra Conventional cylinder	F7	15	M
Sargent Conventional cylinder	F8	15	C
Corbin Conventional cylinder	F9	15	C
Adjustable spring collars	F10	4	M
Corbin Russwin 6 pin IC core	F12	22	C
Corbin Russwin 7 pin IC core	F13	22	C
Yale/Accentra 6 pin IC core	F14	15	C
Yale/Accentra 7 pin IC core	F15	15	C
Less outside knob/lever	F16	NC	M
Less trim with custom escutcheon	F18	NC	M
Schlage 6 pin IC core	F19	15	C
Sargent IC core	F20	15	C
Medeco IC core large format	F21	15	C
Blank inside plate/lever	F25	NC	M
Blank outside plate/lever	F26	NC	M
Yale/Accentra 6 pin IC core w/captivated tail	F27	15	C
Yale/Accentra 710 IC core w/ captivated tail	F28	15	C
Screwless interior escutcheon	F29	38	M

LATCH	CODE	PRICE	TYPE
Solid latch	E1	13	M
Open hold open latch	E2	24	M
Auxiliary latch	E3	23	M
2-3/4" backset, 1-1/8" x 2-1/4" face	E4	8	C,T
2-3/8" back set, 1" x 2-1/4" face	E6	NC	C,T
2-3/4" BS, 9/16" throw, Gr. 1 UL	E7	30	C
2-3/4" BS, 9/16" throw, Gr. 1			
UL listed with cylindrical cartridge *E7 option N function only, 2-3/4BS	E7*	68	T
2-3/8", 2-3/4", 3-3/4" & 5" Backsets			
5" bs, 9/16" throw, Gr. 1 UL	E9	30	C,T
3-3/4" BS, 9/16" throw Gr. UL	E10	30	C
2-3/8" backset, 1-1/8" x 2-1/4" face	E11	9	C,T
2-3/4" backset, 1" x 2-1/4" face	E12	9	C,T
Adjustable latch 1-1/8" x 2-1/4" face	E13	8	T
Adjustable latch 1" x 2-1/4" face UL	E14	12	T
Radius corners on tubular	E15	NC	T
UL latch, adjustable	E16	10	T
Kick off latch (P) 1834P	E17	NC	C



ELECTRIFIED	CODE	PRICE	TYPE
24V	H1	NC	C
12V	H2	NC	C
Electrically locked	H9	NC	M
Electrically unlocked	H10	NC	M

ELECTRONICS	CODE	VALUE	TYPE
Sensor W1 for REX	W1	203	AC
Solid exterior handle no cylinder	W4	NC	IQ
Crescent lever	W7	13	IQ
Request to exit switch	CAP10	101	M
Key sensor	CAP11	101	A,C
Titan lever	W12	13	IQ
REX switch, key, bolt sensor	W13	303	M
Bolt sensor	W14	101	M
Latch sensor	W15	101	M
REX + Latch Sensor	W16	203	M
American Lever US19	W20	15	IQ

FINISHES	ANSI #
US 3 Polished Brass, Clear Coated	605
US 4 Satin Brass, Clear Coated	606
US 5 Antique Brass, Clear Coated	609
US 10 Satin Bronze, Clear Coated	612
US 10B Dark Bronze, Clear Coated	613
US 14 Bright Nickel Plating, Clear Coated	614
US 15 Satin Nickel	619
US 19 Flat Black, Powder Coated	622
US 20A Dark Oxidized Statuary Bronze, Clear Coated	624
US 26 Polished Chrome, Plated	625
US 26D Satin Chrome, Plated	626
US 32 Polished Stainless Steel	629
US 32D Satin Stainless Steel	630

AM Antimicrobial Finish AM, +24

CLASSIC PLATE DESIGN CL

	ANSI-A156.13 • Grade 1 3 Hour Fire Rating		Series 5 • 2-3/4" Backset Series 55 • 2-1/2" Backset		
		Standard Features <ul style="list-style-type: none"> • Thru-bolted screwless knob/lever plate assemblies • Independent spring loaded captivated spindles • Reversible mortise lock 2-1/2" or 2-3/4" backset • Lock front: 1-1/4" x 8" • Dimensions: Ext: 8" H x 2-1/2" W, Int: 8" H x 2-1/2" W • Cylinder: MARKS "C" keyway, 6 pin w/ 2 keys • Height: 7/32" Options available on page 9-10 		KNOBS 10, 20	LEVERS 002, 031, 44, 47C, 55, 57, 72, 77, 78, 82, 83, 86, 92, 96,
		FINISH GROUPS			
MARKS #	FUNCTION	ANSI #	32D	32D	
KEYED SINGLE CYLINDER, NO DEADBOLT					
D	OFFICE VEST.		414.02	511.13	
DW	VESTIBULE				
E	OFFICE	F04			
EW	STOREROOM	F07			
J	CLASSROOM	F05			
JM, JR	HOSPITAL	F06			
GL	INSTIT. PRIVACY	F26			
EL	ELECTRICALLY LOCKED		627.92	724.37	
EU	ELECTRICALLY UNLOCKED				
KEYED SINGLE CYLINDER, WITH DEADBOLT					
A	ENTRANCE	F08, F10	423.21	520.32	
B	ENTRANCE	F21			
F	DORMITORY	F12			
FS	DORMITORY				
FW	DORMITORY	F13			
FD	APARTMENT	F20	465.20	561.65	
H	HOTEL	F15			
LH	SPECIAL PRIVACY				
KEYED DOUBLE CYLINDER, NO DEADBOLT					
G	APARTMENT	F09	446.17	542.62	
GC	INTRUDER LATCHBOLT	F32			
GG	CLASSROOM SECURITY				
GR	CLASSROOM SECURITY w/HOLDBACK				
WW	INSTITUTIONAL	F30			
KEYED DOUBLE CYLINDER, WITH DEADBOLT					
AC	ENTRANCE	F35	446.17	542.62	
C	STOREROOM	F14			
FC	INTRUDER DEADBOLT	F34			
FA	DORMITORY	F11			
FX	DORMITORY	F33			
KEYLESS					
N	PASSAGE	F01	347.75	444.86	
L	BATHROOM	F02	424.52	520.97	
LF	PRIVACY	F19			
LJ	PRIVACY	F22	383.18	479.63	
EX	EXIT	F31	383.18	479.63	
DUMMY TRIM					
DI	DUMMY TRIM INSIDE		175.19	223.08	
DO	DUMMY TRIM OUTSIDE				
DT	FULLY DUMMY		348.40	445.51	
NOTE: Split designs and/or finishes are priced at the highest design and/or finish • Special finishes, consult factory					

KNOBS & LEVERS ARE PACKED 6 PER CASE



NOTE: Split designs and/or finishes are priced at the highest design and/or finish • Special finishes, consult factory

CLASSIC PLATE DESIGN CL

	ANSI-A156.13 • Grade 2		Series 7 • 2-3/4" Backset Series 9 • 2-1/2" Backset	
	Standard Features		KNOBS	LEVERS
	<ul style="list-style-type: none"> • Thru-bolted screwless knob/lever plate assemblies • Independent spring loaded captivated spindles • 2-1/2" or 2-3/4" backset • Cylinder: MARKS "C" keyway, 6 pin w/ 2 keys • Lock front Series 7: 1-1/4" x 8", Series 9: 1-1/16" x 7-5/8" • Dimensions: Ext: 8" H x 2-1/2" W, Int: 8" H x 2-1/2" W • Options available on page 9-10 		10, 20	031, 037A, 44, 47C, 55, 57, 72, 77, 78, 82, 83, 86, 92, 96, 002
FINISH GROUPS				
MARKS #	FUNCTION	ANSI #	32D	32D
KEYED SINGLE CYLINDER, NO DEADBOLT				
D	OFFICE VEST.		392.37	489.47
DW	VESTIBULE			
KEYED SINGLE CYLINDER, WITH DEADBOLT				
A	ENTRANCE	F08, F10	402.21	498.66
B	ENTRANCE	F21		
F	DORMITORY	F12		
FS	DORMITORY			
FW	DORMITORY	F13		
KEYED DOUBLE CYLINDER, WITH DEADBOLT				
AC	ENTRANCE	F35	425.18	521.63
C	STOREROOM	F14		
FX	DORMITORY	F33		
KEYLESS				
N	PASSAGE	F01	326.10	423.21
L	BATHROOM	F02	402.86	499.32
LF	PRIVACY	F19		
DUMMY TRIM				
DI	DUMMY TRIM INSIDE		175.19	223.08
DO	DUMMY TRIM OUTSIDE			
DT	FULLY DUMMY		348.41	445.52
NOTE: Split designs and/or finishes are priced at the highest design and/or finish • Special finishes, consult factory				

KNOBS	Round Knob 10	Ball Knob 20	Commerce Lever 037A	Metropolitan Lever 002
				
	Lucida Lever 47C	Copa Lever 031	Brompton Lever 55	Monaco Lever 57
				
LEVERS	Towne Lever 72	Maxwell Lever 77	Omni Lever 78	Plaza Lever 82
				
	Dayton Lever 83 Specify handing	Crescent Lever 86	American Lever 92	Titan Lever 96
				

CAPITOL PLATE DESIGN CP

		ANSI-A156.13 • Grade 1 3 Hour Fire Rating				Series 5 • 2-3/4" Backset Series 55 • 2-1/2" Backset			
	Standard Features			KNOBS		LEVERS			
	<ul style="list-style-type: none"> • Thru-bolted screwless knob/lever plate assemblies • Independent spring loaded captivated spindles • Reversible mortise lock 2-1/2" or 2-3/4" backset • Lock front: 1-1/4" x 8" • Dimensions: Ext: 8-1/2" H x 2-3/4" W, Int: 8-1/2" H x 2-3/4" W • Cylinder: MARKS "C" keyway, 6 pin w/ 2 keys • Concealed 5 pin cylinder (option A12) • Thickness: 1/8" Options available on page 9-10			10, 20		002, 031, 037A, 47C, 55, 57, 72, 77, 78, 82, 83, 86, 92, 96,		002, 031, 037A, 47C, 82, 83, 86, 92, 96	
						FINISH GROUPS			
MARKS #	FUNCTION	ANSI #	3, 32D	4, 10, 10B, 15, 19	3, 32D	4, 10, 10B, 15, 19			
KEYED SINGLE CYLINDER, NO DEADBOLT									
D	OFFICE VEST.		431.08	456.01	527.54	555.09			
DW	VESTIBULE								
E	OFFICE	F04							
EW	STOREROOM	F07							
J	CLASSROOM	F05							
JM, JR	HOSPITAL	F06							
GL	INSTIT. PRIVACY	F26							
EL	ELECTRICALLY LOCKED		644.98	669.92	741.43	766.37			
EU	ELECTRICALLY UNLOCKED								
KEYED SINGLE CYLINDER, WITH DEADBOLT									
A	ENTRANCE	F08, F10	440.27	465.85	537.38	562.31			
B	ENTRANCE	F21							
F	DORMITORY	F12							
FS	DORMITORY								
FW	DORMITORY	F13							
FD	APARTMENT	F20	481.60	506.54	578.71	604.30			
H	HOTEL	F15							
LH	SPECIAL PRIVACY								
KEYED DOUBLE CYLINDER, NO DEADBOLT									
G	APARTMENT	F09	463.89	488.82	560.34	585.27			
GC	INTRUDER LATCHBOLT	F32							
GG	CLASSROOM SECURITY								
GR	CLASSROOM SECURITY w/HOLDBACK								
WW	INSTITUTIONAL	F30							
KEYED DOUBLE CYLINDER, WITH DEADBOLT									
AC	ENTRANCE	F35	463.89	488.82	560.34	585.27			
C	STOREROOM	F14							
FC	INTRUDER DEADBOLT	F34							
FA	DORMITORY	F11							
FX	DORMITORY	F33							
KEYLESS									
N	PASSAGE	F01	365.47	390.40	462.57	487.51			
L	BATHROOM	F02	441.58	466.51	538.03	562.96			
LF	PRIVACY	F19							
LJ	PRIVACY	F22	400.90	425.83	497.35	522.28			
EX	EXIT	F31							
DUMMY TRIM									
DI	DUMMY TRIM INSIDE		182.41	195.53	230.96	244.08			
DO	DUMMY TRIM OUTSIDE								
DT	FULLY DUMMY		365.47	391.06	463.23	464.92			

KNOBS & LEVERS ARE PACKED 6 PER CASE



NOTE: Split designs and/or finishes are priced at the highest design and/or finish • Special finishes, consult factory

CAPITOL PLATE DESIGN CP

		ANSI-A156.13 • Grade 2		Series 7 • 2-3/4" Backset Series 9 • 2-1/2" Backset			
		Standard Features		KNOBS		LEVERS	
<ul style="list-style-type: none"> • Thru-bolted screwless knob/lever plate assemblies • Independent spring loaded captivated spindles • 2-1/2" or 2-3/4" backset • Lock front Series 7: 1-1/4" x 8", Series 9: 1-1/16" x 7-5/8" • Dimensions: Ext: 8-1/2" H x 2-3/4" W, Int: 8-1/2" H x 2-3/4" W • Cylinder: MARKS "C" keyway, 6 pin w/ 2 keys • Options available on page 9-10 				10, 20		002 031, 037A, 47C, 55, 57, 72, 77, 78, 82, 83, 86, 92, 96	
				FINISH GROUPS			
MARKS #	FUNCTION	ANSI #	3, 32D	4, 10, 10B, 15, 19	3, 32D	4, 10, 10B, 15, 19	
KEYED SINGLE CYLINDER, NO DEADBOLT							
D	OFFICE VEST.		409.43	434.36	505.88	532.12	
DW	VESTIBULE						
KEYED SINGLE CYLINDER, WITH DEADBOLT							
A	ENTRANCE	F08, F10	419.27	444.21	515.72	540.66	
B	ENTRANCE	F21					
F	DORMITORY	F12					
FS	DORMITORY						
FW	DORMITORY	F13					
KEYED DOUBLE CYLINDER, WITH DEADBOLT							
AC	ENTRANCE	F35	442.23	467.17	538.69	563.62	
C	STOREROOM	F14					
FX	DORMITORY	F33					
KEYLESS							
N	PASSAGE	F01	344.13	368.75	440.93	465.85	
L	BATHROOM	F02	419.92	444.86	516.38	541.31	
LF	PRIVACY	F19					
DUMMY TRIM							
DI	DUMMY TRIM INSIDE		182.41	195.53	230.96	244.08	
DO	DUMMY TRIM OUTSIDE						
DT	FULLY DUMMY		365.47	391.06	463.23	488.17	
NOTE: SPLIT DESIGNS AND/OR FINISHES ARE PRICED AT THE HIGHEST DESIGN AND/OR FINISH • SPECIAL FINISHES, CONSULT FACTORY							

KNOBS	Round Knob 10 	Ball Knob 20 	Commerce Lever 037A 	Metropolitan Lever 002 
	Lucida Lever 47C 	Copa Lever 031 	Brompton Lever 55 	Monaco Lever 57 
	Towne Lever 72 	Maxwell Lever 77 	Omni Lever 78 	Plaza Lever 82 
	Dayton Lever 83 Specify handing 	Crescent Lever 86 	American Lever 92 	Titan Lever 96 

CROWN PLATE DESIGN CR

		ANSI-A156.13 • Grade 1 3 Hour Fire Rating				Series 5 • 2-3/4" Backset Series 55 • 2-1/2" Backset		
	Standard Features			KNOBS		LEVERS		
	<ul style="list-style-type: none"> • Thru-bolted screwless knob/lever plate assemblies • Independent spring loaded captivated spindles • Reversible mortise lock 2-1/2" or 2-3/4" backset • Lever support springs • Lock front: 1-1/4" x 8" • Dimensions: Ext: 8-1/2" H x 2" W, Int: 8-1/2" H x 2" W • Cylinder: MARKS "C" keyway, 6 pin w/ 2 keys • Height: 13/32" • Square Edges Options available on page 9-10 			10, 20		002, 031,037A, 47C, 55, 57, 72, 77, 78, 82, 83, 86, 92, 96		002, 031,037A, 47C, 82, 83, 86, 92, 96
MARKS #	FUNCTION	ANSI #	3, 26D, 32D	10, 10B, 32	3, 15, 26D	4, 10, 10B, 14, 19, 26	32, 32D	
KEYED SINGLE CYLINDER, NO DEADBOLT								
D	OFFICE VEST.		445.52	470.45	513.10	562.96	538.03	
DW	VESTIBULE							
E	OFFICE	F04						
EW	STOREROOM	F07						
J	CLASSROOM	F05						
JM, JR	HOSPITAL	F06						
GL	INSTIT. PRIVACY	F26						
EL	ELECTRICALLY LOCKED		658.76	684.35	716.50	766.37	741.43	
EU	ELECTRICALLY UNLOCKED							
KEYED SINGLE CYLINDER, WITH DEADBOLT								
A	ENTRANCE	F08, F10	454.70	479.63	522.28	572.15	547.22	
B	ENTRANCE	F21						
F	DORMITORY	F12						
FS	DORMITORY							
FW	DORMITORY	F13						
FD	APARTMENT	F20	469.14	494.07	536.72	586.59	561.65	
H	HOTEL	F15						
LH	SPECIAL PRIVACY							
KEYED DOUBLE CYLINDER, NO DEADBOLT								
G	APARTMENT	F09	475.04	499.97	541.97	592.49	567.56	
GC	INTRUDER LATCHBOLT	F32						
GG	CLASSROOM SECURITY							
GR	CLASSROOM SECURITY w/HOLDBACK							
WW	INSTITUTIONAL	F30						
KEYED DOUBLE CYLINDER, WITH DEADBOLT								
AC	ENTRANCE	F35	475.04	499.97	541.97	592.49	567.56	
C	STOREROOM	F14						
FC	INTRUDER DEADBOLT	F34						
FA	DORMITORY	F11						
FX	DORMITORY	F33						
KEYLESS								
N	PASSAGE	F01	382.53	407.46	450.11	499.97	475.04	
L	BATHROOM	F02	454.70	479.63	522.28	572.15	547.22	
LF	PRIVACY	F19						
LJ	PRIVACY	F22	415.99	441.58	483.57	534.10	509.16	
EX	EXIT	F31						
DUMMY TRIM								
DI	DUMMY TRIM INSIDE		190.93	205.37	227.02	264.42	239.49	
DO	DUMMY TRIM OUTSIDE							
DT	FULLY DUMMY		385.81	410.74	453.39	503.25	478.32	

KNOBS & LEVERS ARE PACKED 6 PER CASE



NOTE: Split designs and/or finishes are priced at the highest design and/or finish • Special finishes, consult factory

CROWN PLATE DESIGN CR

ANSI-A156.13 • Grade 2			Series 7 • 2-3/4" Backset Series 9 • 2-1/2" Backset				
Standard Features			KNOBS		LEVERS		
<ul style="list-style-type: none"> • Thru-bolted screwless knob/lever plate • Independent spring loaded captivated spindles • 2-1/2" or 2-3/4" backset • Lever support springs • Lock front Series 7: 1-1/4" x 8", Series 9: 1-1/16" x 7-5/8" • Dimensions: Ext: 8-1/2" H x 2" W, Int: 8-1/2" H x 2" W • Cylinder: MARKS "C" keyway, 6 pin w/ 2 keys • Options available on page 9-10 			10, 20		002, 031,037A, 47c 55, 57, 72, 77, 78, 82, 83, 86, 92, 96		002, 031,037A, 47C, 82, 83, 86, 92,96
			FINISH GROUPS				
MARKS #	FUNCTION	ANSI #	3, 26D, 32D	10, 10B, 32	3, 15, 26D	4, 10, 10B, 14, 19	32, 32D
KEYED SINGLE CYLINDER, NO DEADBOLT							
D	OFFICE VEST.		424.52	449.45	491.45	541.31	516.38
DW	VESTIBULE						
KEYED SINGLE CYLINDER, WITH DEADBOLT							
A	ENTRANCE	F08, F10	433.05	457.98	500.63	550.50	525.56
B	ENTRANCE	F21					
F	DORMITORY	F12					
FS	DORMITORY						
FW	DORMITORY						
KEYED DOUBLE CYLINDER, WITH DEADBOLT							
AC	ENTRANCE	F35	447.56	478.32	520.97	570.84	545.90
C	STOREROOM	F14					
FX	DORMITORY	F33					
KEYLESS							
N	PASSAGE	F01	360.88	385.81	428.46	478.32	453.39
L	BATHROOM	F02	433.05	457.98	500.63	550.50	525.56
LF	PRIVACY	F19					
DUMMY TRIM							
DI	DUMMY TRIM INSIDE		190.93	205.37	227.02	264.42	239.49
DO	DUMMY TRIM OUTSIDE						
DT	FULLY DUMMY		385.81	410.74	453.39	503.25	478.32
KNOBS & LEVERS ARE PACKED 6 PER CASE							
NOTE: Split designs and/or finishes are priced at the highest design and/or finish • Special finishes, consult factory							

KNOBS	Round Knob 10	Ball Knob 20	Commerce Lever 037A	Metropolitan Lever 002
				
	Lucida Lever 47C	Copa Lever 031	Brompton Lever 55	Monaco Lever 57
				
LEVERS	Towne Lever 72	Maxwell Lever 77	Omni Lever 78	Plaza Lever 82
				
	Dayton Lever 83 Specify handing	Crescent Lever 86	American Lever 92	Titan Lever 96
				

DRAKE PLATE DESIGN DR

		ANSI-A156.13 • Grade 1 3 Hour Fire Rating				Series 5 • 2-3/4" Backset Series 55 • 2-1/2" Backset		
	Standard Features			KNOBS		LEVERS		
	<ul style="list-style-type: none"> • Thru-bolted screwless knob/lever plate • Independent spring loaded captivated spindles • Reversible mortise lock 2-1/2" or 2-3/4" backset • Lever support springs • Lock front: 1-1/4" x 8" • Dimensions: Ext: 11" H x 2-1/2" W, Int: 11" H x 2-1/2" W • Cylinder: MARKS "C" keyway, 6 pin w/ 2 keys • Height: 13/32" • Square Edges Options available on page 9-10 			10, 20		002, 031,037A, 47C, 55, 57, 72, 77, 78, 82, 83, 86, 92, 96		002, 031,037A 47C, 82, 83, 86, 92, 96
MARKS #	FUNCTION	ANSI #	3, 26D, 32D	10, 10B, 32	3, 15, 26D	4, 10, 10B, 14, 19, 26	32, 32D	
KEYED SINGLE CYLINDER, NO DEADBOLT								
D	OFFICE VEST.		492.10	517.04	559.68	609.55	584.62	
DW	VESTIBULE							
E	OFFICE	F04						
EW	STOREROOM	F07						
J	CLASSROOM	F05						
JM, JR	HOSPITAL	F06						
GL	INSTIT. PRIVACY	F26						
EL	ELECTRICALLY LOCKED		705.34	730.28	763.09	812.95	788.02	
EU	ELECTRICALLY UNLOCKED							
KEYED SINGLE CYLINDER, WITH DEADBOLT								
A	ENTRANCE	F08, F10	501.11	526.22	568.87	618.73	593.80	
B	ENTRANCE	F21						
F	DORMITORY	F12						
FS	DORMITORY							
FW	DORMITORY	F13						
FD	APARTMENT	F20	515.72	540.66	582.65	633.17	608.24	
H	HOTEL	F15						
LH	SPECIAL PRIVACY							
KEYED DOUBLE CYLINDER, NO DEADBOLT								
G	APARTMENT	F09	521.63	546.56	588.55	639.07	613.49	
GC	INTRUDER LATCHBOLT	F32						
GG	CLASSROOM SECURITY							
GR	CLASSROOM SECURITY w/HOLDBACK							
WW	INSTITUTIONAL	F30						
KEYED DOUBLE CYLINDER, WITH DEADBOLT								
AC	ENTRANCE	F35	521.63	546.56	588.55	639.07	613.49	
C	STOREROOM	F14						
FC	INTRUDER DEADBOLT	F34						
FA	DORMITORY	F11						
FX	DORMITORY	F33						
KEYLESS								
N	PASSAGE	F01	429.11	454.05	496.69	546.56	521.63	
L	BATHROOM	F02	501.29	526.22	568.87	618.73	593.80	
LF	PRIVACY	F19						
LJ	PRIVACY	F22	463.23	488.17	530.16	580.68	555.74	
EX	EXIT	F31						
DUMMY TRIM								
DI	DUMMY TRIM INSIDE		216.52	228.99	249.99	288.05	263.11	
DO	DUMMY TRIM OUTSIDE							
DT	FULLY DUMMY		432.39	450.77	499.97	549.84	524.91	

KNOBS & LEVERS ARE PACKED 6 PER CASE



NOTE: Split designs and/or finishes are priced at the highest design and/or finish • Special finishes, consult factory

DRAKE PLATE DESIGN DR

	ANSI-A156.13 • Grade 2		Series 7 • 2-3/4" Backset Series 9 • 2-1/2" Backset				
	Standard Features		KNOBS		LEVERS		
	<ul style="list-style-type: none"> • Thru-bolted screwless knob/lever plate • Independent spring loaded captivated spindles • 2-1/2" or 2-3/4" backset • Lever support springs • Lock front Series 7: 1-1/4" x 8", Series 9: 1-1/16" x 7-5/8" • Dimensions: Ext: 11" H x 2-1/2" W, Int: 11" H x 2-1/2" W • Cylinder: MARKS "C" keyway, 6 pin w/ 2 keys • Options available on page 9-10 		10, 20		002, 031, 037A, 47C, 55, 57, 72, 77, 78, 82, 83, 86, 92, 96		
MARKS #	FUNCTION	ANSI #	FINISH GROUPS				
			3, 26D, 32D	10, 10B, 32	3, 15, 26D	4, 10, 10B, 14, 19, 26, 32	32D
KEYED SINGLE CYLINDER, NO DEADBOLT							
D	OFFICE VEST.		471.76	496.04	538.03	587.90	562.96
DW	VESTIBULE						
KEYED SINGLE CYLINDER, WITH DEADBOLT							
A	ENTRANCE	F08, F10	479.63	504.57	547.22	597.74	572.15
B	ENTRANCE	F21					
F	DORMITORY	F12					
FS	DORMITORY						
KEYED DOUBLE CYLINDER, WITH DEADBOLT							
AC	ENTRANCE	F35	499.97	524.91	567.56	617.43	592.49
C	STOREROOM	F14					
FX	DORMITORY	F33					
KEYLESS							
N	PASSAGE	F01	407.46	432.39	475.04	524.91	499.97
L	BATHROOM	F02	479.63	504.57	558.89	597.74	572.15
LF	PRIVACY	F19					
DUMMY TRIM							
DI	DUMMY TRIM INSIDE		216.52	228.99	249.99	288.05	263.11
DO	DUMMY TRIM OUTSIDE						
DT	FULLY DUMMY		432.09	450.77	499.97	549.84	524.91
NOTE: Split designs and/or finishes are priced at the highest design and/or finish • Special finishes, consult factory							

KNOBS	Round Knob 10	Ball Knob 20	Commerce Lever 037A	Metropolitan Lever 002
				
	Lucida Lever 47C	Copa Lever 031	Brompton Lever 55	Monaco Lever 57
				
LEVERS	Towne Lever 72	Maxwell Lever 77	Omni Lever 78	Plaza Lever 82
				
	Dayton Lever 83 Specify handing	Crescent Lever 86	American Lever 92	Titan Lever 96
				

NEW YORKER PLATE DESIGN NY

		ANSI-A156.13 • Grade 1 3 Hour Fire Rating		Series 5 • 2-3/4" Backset Series 55 • 2-1/2" Backset			
	Standard Features		KNOBS		LEVERS		
	<ul style="list-style-type: none"> • Thru-bolted screwless knob/lever plate assemblies • Independent spring loaded captivated spindles • Reversible mortise lock 2-1/2" or 2-3/4" backset • Lever support springs • Lock front: 1-1/4" x 8" • Dimensions: Ext: 10" H x 2-3/4" W, *Int: 7" H x 2-1/4" W • Cylinder: MARKS "C" keyway, 6 pin w/ 2 keys • Thickness: 1/4" • Options available on page 9-10 		10, 20		002, 031,037A, 47C, 55, 57, 72, 77, 78, 82, 83, 86, 92, 96		
	MARKS #		FUNCTION	ANSI #	FINISH GROUPS		
				3	26D	3	26D
KEYED SINGLE CYLINDER, NO DEADBOLT							
D	OFFICE VEST.						
DW	VESTIBULE						
E	OFFICE	F04					
EW	STOREROOM	F07	283.45	309.04	348.41	374.66	
J	CLASSROOM	F05					
JM, JR	HOSPITAL	F06					
GL	INSTIT. PRIVACY	F26					
EL	ELECTRICALLY LOCKED		518.35	544.59	584.62	581.34	
EU	ELECTRICALLY UNLOCKED						
KEYED SINGLE CYLINDER, WITH DEADBOLT							
A	ENTRANCE	F08, F10					
B	ENTRANCE	F21					
F	DORMITORY	F12	294.61	318.23	360.22	385.81	
FS	DORMITORY						
FW	DORMITORY	F13					
FD	APARTMENT	F20					
H	HOTEL	F15	311.01	336.59	377.28	402.87	
LH	SPECIAL PRIVACY						
KEYED DOUBLE CYLINDER, NO DEADBOLT							
G	APARTMENT	F09					
GC	INTRUDER LATCHBOLT	F32					
GG	CLASSROOM SECURITY		316.91	348.41	382.53	408.12	
GR	CLASSROOM SECURITY w/HOLDBACK						
WW	INSTITUTIONAL	F30					
KEYED DOUBLE CYLINDER, WITH DEADBOLT							
AC	ENTRANCE	F35					
C	STOREROOM	F14					
FC	INTRUDER DEADBOLT	F34	316.91	348.41	382.53	408.12	
FA	DORMITORY	F11					
FX	DORMITORY	F33					
KEYLESS							
N	PASSAGE	F01	209.96	235.56	275.57	301.48	
L	BATHROOM	F02					
LF	PRIVACY	F19	294.27	318.23	360.22	385.81	
LJ	PRIVACY	F22					
EX	EXIT	F31	249.33	274.92	314.95	341.19	
DUMMY TRIM							
DI	DUMMY TRIM INSIDE		107.60	120.08	141.73	167.31	
DO	DUMMY TRIM OUTSIDE						
DT	FULLY DUMMY		214.56	240.14	279.51	306.41	

KNOBS & LEVERS ARE PACKED 6 PER CASE

NOTE: Split designs and/or finishes are priced at the highest design and/or finish • Special finishes, consult factory

* Large interior plate available (10" H x 2-3/4" W)

NEW YORKER PLATE DESIGN NY



	ANSI-A156.13 • Grade 2		Series 7 • 2-3/4" Backset Series 9 • 2-1/2" Backset			
	Standard Features		KNOBS		LEVERS	
	<ul style="list-style-type: none"> • Thru-bolted screwless knob/lever plate assemblies • Independent spring loaded captivated spindles • 2-1/2" or 2-3/4" backset • Lever support springs • Lock front Series 7: 1-1/4" x 8", Series 9: 1-1/16" x 7-5/8" • Dimensions: Ext: 10" H x 2-3/4" W, *Int: 7" H x 2-1/4" W • Cylinder: MARKS "C" keyway, 6 pin w/ 2 keys Options available on page 9-10 		10, 20		002, 031, 037A, 47C, 65, 57, 72, 77, 78, 82, 83, 86, 92, 96	
FINISH GROUPS						
MARKS #	FUNCTION	ANSI #	3	26D	3	26D
KEYED SINGLE CYLINDER, NO DEADBOLT						
D	OFFICE VEST.		236.64	259.77	302.47	325.60
DW	VESTIBULE					
KEYED SINGLE CYLINDER, WITH DEADBOLT						
A	ENTRANCE	F08, F10	246.72	268.07	306.03	329.75
B	ENTRANCE	F21				
F	DORMITORY	F12				
FS	DORMITORY					
FW	DORMITORY	F13				
KEYED DOUBLE CYLINDER, WITH DEADBOLT						
AC	ENTRANCE	F35	266.89	290.02	326.19	349.32
C	STOREROOM	F14				
FX	DORMITORY	F33				
KEYLESS						
N	PASSAGE	F01	171.40	193.94	230.10	252.65
L	BATHROOM	F02	246.72	268.07	332.72	355.85
LF	PRIVACY	F19				
DUMMY TRIM						
DI	DUMMY TRIM INSIDE		107.60	120.08	141.73	167.31
DO	DUMMY TRIM OUTSIDE					
DT	FULLY DUMMY		214.56	240.14	279.51	306.41

KNOBS & LEVERS ARE PACKED 6 PER CASE

NOTE: Split designs and/or finishes are priced at the highest design and/or finish • Special finishes, consult factory
* Large interior plate available (10" H x 2-3/4" W)

KNOBS	Round Knob 10 	Ball Knob 20 	Commerce Lever SF037A 	Metropolitan Lever 002 
	Lucida Lever 47C 	Copa Lever 031 	Brompton Lever 55 	Monaco Lever 57 Specify handing 
	Towne Lever 72 	Maxwell Lever 77 	Omni Lever 78 	Plaza Lever 82 
	Dayton Lever 83 Specify handing 	Crescent Lever 86 	American Lever 92 	Titan Lever 96 

ROSE DESIGN RR, RW, RQ, RS, RX*, RK*, RL*

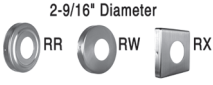
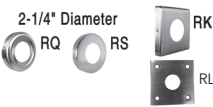
		ANSI-A156.13 • Grade 1 3 Hour Fire Rating		Series 5 • 2-3/4" Backset Series 55 • 2-1/2" Backset				
		Standard Features		KNOBS		LEVERS		
		<ul style="list-style-type: none"> • Thru-bolted screwless knob/lever rose assemblies • Independent spring loaded captivated spindles • Reversible mortise lock 2-1/2" or 2-3/4" backset • Lever support springs • Lock front: 1-1/4" x 8" • Cylinder: MARKS "C" keyway, 6 pin w/ 2 keys Options available on page 9-10		10, 20		002, 031,037A, 47C 55, 57, 72, 77, 78, 82, 83, 86, 92, 96		
				FINISH GROUPS				
MARKS #	FUNCTION	ANSI #	3, 32D	3, 4, 15, 26D	14, 26, 32	10, 10B, 19	32D	
KEYED SINGLE CYLINDER, NO DEADBOLT								
D	OFFICE VEST.		378.59	402.86	427.80	452.73	402.86	
DW	VESTIBULE							
E	OFFICE	F04						
EW	STOREROOM	F07						
J	CLASSROOM	F05						
JM, JR	HOSPITAL	F06						
GL	INSTIT. PRIVACY	F26	591.83	616.11	641.05	658.76	616.11	
EL	ELECTRICALLY LOCKED							
EU	ELECTRICALLY UNLOCKED							
KEYED SINGLE CYLINDER, WITH DEADBOLT								
A	ENTRANCE	F08, F10	387.12	412.05	436.99	454.70	412.05	
B	ENTRANCE	F21						
F	DORMITORY	F12						
FS	DORMITORY							
FW	DORMITORY	F13	402.21	426.49	451.42	469.14	426.49	
FD	APARTMENT	F20						
H	HOTEL	F15						
LH	SPECIAL PRIVACY							
KEYED DOUBLE CYLINDER, NO DEADBOLT								
G	APARTMENT	F09	407.46	431.74	456.67	475.04	431.74	
GC	INTRUDER LATCHBOLT	F32						
GG	CLASSROOM SECURITY							
GR	CLASSROOM SECURITY w/HOLDBACK							
WW	INSTITUTIONAL	F30	407.46	431.74	456.67	475.04	431.74	
AC	ENTRANCE	F35						
C	STOREROOM	F14						
FC	INTRUDER DEADBOLT	F34						
FA	DORMITORY	F11						
FX	DORMITORY	F33						
KEYLESS								
N	PASSAGE	F01	293.95	369.40	394.99	399.58	369.40	
L	BATHROOM	F02	387.12	412.05	436.99	454.70	412.05	
LF	PRIVACY	F19						
LJ	PRIVACY	F22	348.41	373.34	398.28	415.99	373.34	
EX	EXIT	F31						
DUMMY TRIM								
DI	DUMMY TRIM INSIDE		107.60	120.08	141.73	163.81	91.20	
DO	DUMMY TRIM OUTSIDE							
DT	FULLY DUMMY		214.56	240.14	279.51	306.41	181.09	

KNOBS & LEVERS ARE PACKED 6 PER CASE

NOTE: Split designs and/or finishes are priced at the highest design and/or finish • Special finishes, consult factory

*Square Rose RX: Add \$21 / *Square Rose RL: Add \$47 / *Square Rose RK: Add \$65

ROSE DESIGN RR, RW, RQ, RS, RX*, RK*, RL*

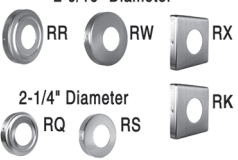
2-9/16" Diameter		ANSI-A156.13 • Grade 2		Series 7 • 2-3/4" Backset Series 9 • 2-1/2" Backset											
Standard Features		KNOBS		LEVERS											
		<ul style="list-style-type: none"> • Thru-bolted screwless knob/lever rose assemblies • Independent spring loaded captivated spindles • 2-1/2" or 2-3/4" backset • Lever support springs • Lock front Series 7: 1-1/4" x 8"; Series 9: 1-1/16" x 7-5/8" • Cylinder: MARKS "C" keyway, 6 pin w/ 2 keys Options available on page 9-10 		10, 20		002, 031, 037A, 47C, 55, 57, 72, 77, 78, 82, 83, 86, 92, 96		002, 031, 037A 47C, 82, 83, 86, 92, 96							
MARKS #		FUNCTION		ANSI #		3, 32D		3, 4, 15, 26D		14, 26, 32		10, 10B, 19		32D	
KEYED SINGLE CYLINDER, NO DEADBOLT															
D		OFFICE VEST.				356.94		381.80		406.15		424.52		381.80	
DW		VESTIBULE													
KEYED SINGLE CYLINDER, WITH DEADBOLT															
A		ENTRANCE		F08, F10											
B		ENTRANCE		F21											
F		DORMITORY		F12		366.12		410.08		435.02		453.39		410.08	
FS		DORMITORY													
FW		DORMITORY		F13											
KEYED DOUBLE CYLINDER, WITH DEADBOLT															
AC		ENTRANCE		F35											
C		STOREROOM		F14		385.81		410.08		435.02		453.39		410.08	
FX		DORMITORY		F33											
KEYLESS															
N		PASSAGE		F01		293.95		318.23		343.16		360.88		318.23	
L		BATHROOM		F02		366.12		390.40		456.01		433.05		390.40	
LF		PRIVACY		F19											
DUMMY TRIM															
DI		DUMMY TRIM INSIDE				107.60		120.08		141.73		163.81		91.20	
DO		DUMMY TRIM OUTSIDE													
DT		FULLY DUMMY				214.56		240.14		279.51		306.41		181.09	
KNOBS & LEVERS ARE PACKED 6 PER CASE															
NOTE: Split designs and/or finishes are priced at the highest design and/or finish • Special finishes, consult factory *Square Rose RX: Add \$21 / *Square Rose RZ: Add \$47 / *Square Rose RK: Add \$65															

KNOBS	Round Knob 10	Ball Knob 20	Commerce Lever 037A	Metropolitan Lever 002	ROSES	RR: 2-9/16" dia.
						
	Lucida Lever 47C	Copa Lever 031	Brompton Lever 55	Monaco Lever 57 Specify handing		RW: 2-9/16" dia.
						
LEVERS	Towne Lever 72	Maxwell Lever 77	Omni Lever 78	Plaza Lever 82	RQ: 2-1/4" dia.	
						
	Dayton Lever 83 Specify handing	Crescent Lever 86	American Lever 92	Titan Lever 96	RS: 2-1/4" dia.	
						
				RX: 2-1/2" sq. WK: 2-1/2" sq. RL: 2-1/2" sq.  Wrought  Forged  Forged		

ORNAMENTAL IRON

Ornamental Iron

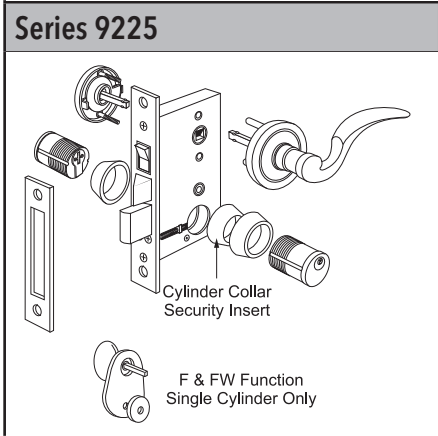
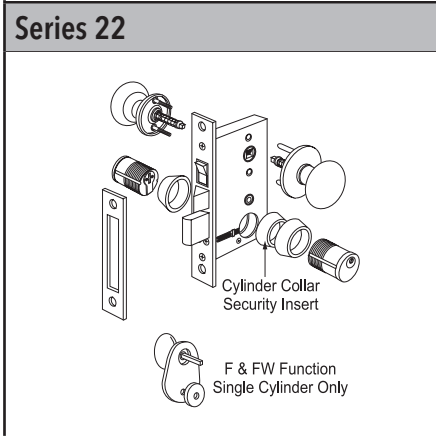
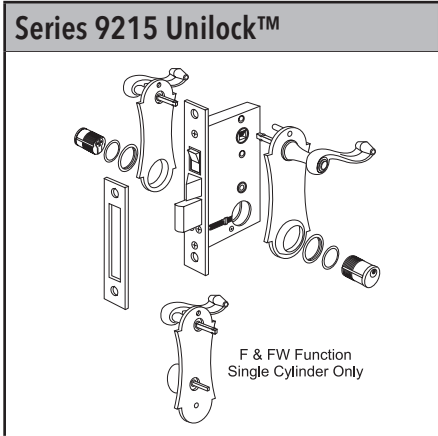
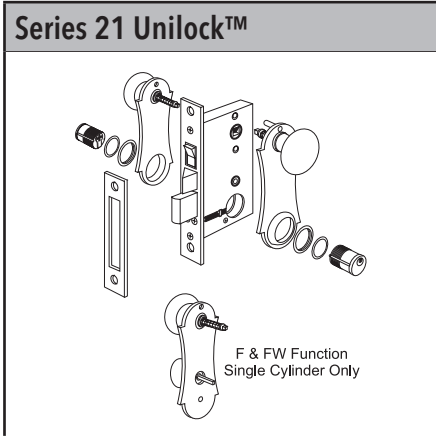

Standard Features		SERIES		
<ul style="list-style-type: none"> • Thru-bolted solid brass trim assemblies • Spring loaded captivated spindles • Reversible mortise lock 1" backset • 1" bolt, 1/2" latch projection • Cylinder: Marks "A" keyway, 5 pin w/ 2 keys; keyed alike - 6 		2750 THINLINE®		
		FINISH GROUPS		
MARKS #	FUNCTION	3	10B(19)	5, 26D
KEYED WITH DEADBOLT				
B	ENTRANCE CYLINDER x TURNPIECE	137.65	173.56	154.94
C	ENTRANCE DOUBLE CYLINDER			
DUMMY TRIM				
DT	FULL DUMMY	83.12	115.71	96.42
ORNAMENTAL IRON LOCKSETS PACKED 6 PER CASE				

Standard Features		SERIES 21 UNILOCK™ SERIES 22		SERIES 9215 UNILOCK™ SERIES 9225			
<ul style="list-style-type: none"> • Door thickness: 1" • Series 9 lock body, Backset: 2-1/2" • Reversible mortise lock 1" bolt, 1/2" latch projection • Lock front Series 7: 1-1/4" x 8"; Series 9: 1-1/16" x 7-5/8" • Thru-bolted solid brass trim assemblies • Spring loaded captivated spindles • 5/16" Cylinder: Marks "A" keyway, 5 pin w/ 2 keys; keyed alike-6 		FINISH GROUPS					
MARKS #	FUNCTION	3	10B(19)	5, 26D	3	10B(19)	5, 26D
KEYED SINGLE CYLINDER, WITH DEADBOLT							
DW	SINGLE CYL. PANIC PROOF						
F	SINGLE CYL. PANIC PROOF	184.87	220.78	196.84	246.72	278.64	259.35
FW	SINGLE CYL. PANIC PROOF						
KEYED DOUBLE CYLINDER, WITH DEADBOLT							
AC	ENTRANCE	164.25	202.16	176.23	226.76	259.35	238.74
DUMMY TRIM							
DT	FULL DUMMY	109.72	151.62	117.70	176.23	213.46	184.87
ORNAMENTAL IRON LOCKSETS ARE PACKED 6 PER CASE							

OPTIONS - Series 2750	CODE	PRICE
For 1-3/4" doors	D4	NC
Marks "C" keyway	G5	11

OPTIONS	CODE	PRICE
Lock Front: 1" x 7-1/8" standard	W	NC
Mushroom knob interior; 1-7/8" prj.	A9	4
For 1-3/4" doors	D4	NC
Adjustable spring collars	F10	4

How To Order Example for Ornamental Iron Locksets					
9215	AC	/	10B	-	D4
<i>1. Lock Series</i>	<i>2. Marks Function</i>	<i>Slash</i>	<i>3. Finish</i>	<i>Dash</i>	<i>4. Options</i>
LOCK SERIES (Pgs. 49 & 50)	MARKS FUNCTION (Pgs. 57-58)		FINISH (Pg. 10)		OPTIONS
___ 21 ___ 2750	___ B ___ AC		___ 3 ___ 10B(19)		___ Special
___ 22 ___ 9215	___ C ___ DT		___ 5 ___ 26D		Specify
	___ F ___ DW				• Keying • Handing
					• Door Thickness

ORNAMENTAL IRON

Knob & Lever Kits

Ornamental Iron

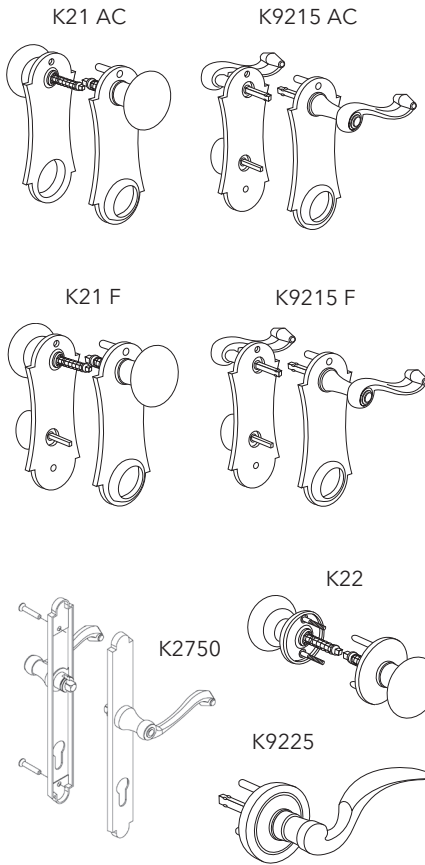

PART #	DESCRIPTION	FUNCTION	FINISH GROUPS			
			3	4	10B(19)	5, 26D
K21AC	Ext./Int. UNILOCK™ knob/plate kit	AC	81.13	-	105.73	89.78
K21AC-M	Ext./Int. UNILOCK™ knob/plate kit (Mushroom Int.)	AC	91.10	-	109.06	93.77
K21F	Ext./Int. UNILOCK™ knob/plate kit assemblies	F	97.09	-	117.04	101.75
K21F-M	Ext./Int. UNILOCK™ knob/plate kit (Mushroom Int.)	F	100.41	-	121.03	105.73
K2750	LEVER PLATE TRIM SET		97.09	-	125.69	110.39
2600B	Thinline lock body, latch, deadbolt US 4 & 26D ONLY - Strike not included		-	80.47	125.69	110.39
K9215AC	Ext./Int. UNILOCK™ lever/plate kit assemblies	AC	122.36	-	144.97	129.68
K9215F	Ext./Int. UNILOCK™ lever/plate kit assemblies	F	122.36	-	158.93	143.64
A9214-M	UNILOCK™ mushroom knob/plate (w/cylinder hole)	AC	45.22	-	63.18	47.21
K9217-M	UNILOCK™ mushroom knob/plate (w/turnpiece)	F	79.14	-	96.42	81.13
K22	Ext./Int. knob/rose kit 1" thru 1-3/4" door		47.21	-	72.48	57.19
K22-M	Ext./Int. knob/rose kit (mushroom int.)		51.87	-	75.81	60.51
K9225	Ext./Int. lever/rose kit		119.70	-	140.98	125.69

Accessories

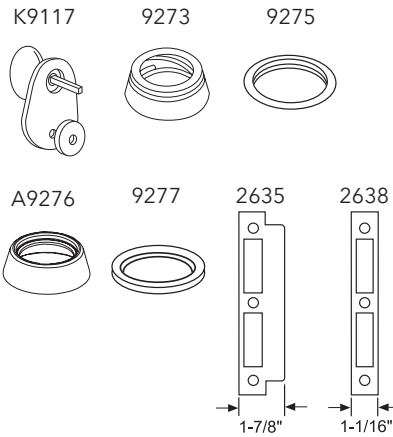

PART #	DESCRIPTION	FINISH GROUPS		
		NO FINISH	3	5, 26D
K9117	Turnpiece kit	-	31.26	33.25
A9223-M	Interior knob/rose assembly (mushroom knob)	-	26.60	31.26
9273	Spring collar, 7/16" high	-	7.98	10.17
9275	Mortise spacer, wrought brass, 1/8" high	-	3.99	-
A9276	Collar, wrought brass w/insert, 1/2" high	-	13.96	13.96
9277	Plastic spacer ring, 1/16"	0.66	-	-
2635	Curved lip strike, solid brass	-	15.96	9.97
2638	Flat strike, solid brass, no lip	-	9.97	4.65

Cylinders

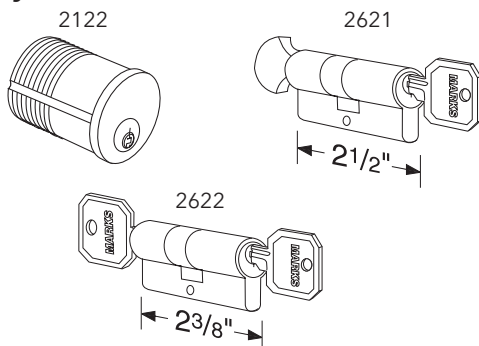

PART #	DESCRIPTION	FINISH GROUPS	
		3	5, 26D
2122-A	5 Pin mortise cylinder, "A" keyway, 15/16"	24.86	26.07
2621-A	Cylinder x turnpiece unit, "A" keyway	40.62	45.16
2622-A	Double cylinder unit, "A" keyway	29.10	36.38
2122-C	5 Pin mortise cylinder, "C" keyway	24.86	26.07
2621-C	Cylinder x turnpiece unit, "C" keyway	40.62	44.87
2622-C	Double cylinder unit, "C" keyway	29.10	36.38

MORTISE LOCK BODIES

AUTOREVERSE SERIES

GRADE 1
MORTISE LOCKS EXCEEDS
BHMA
SPECIFICATIONS

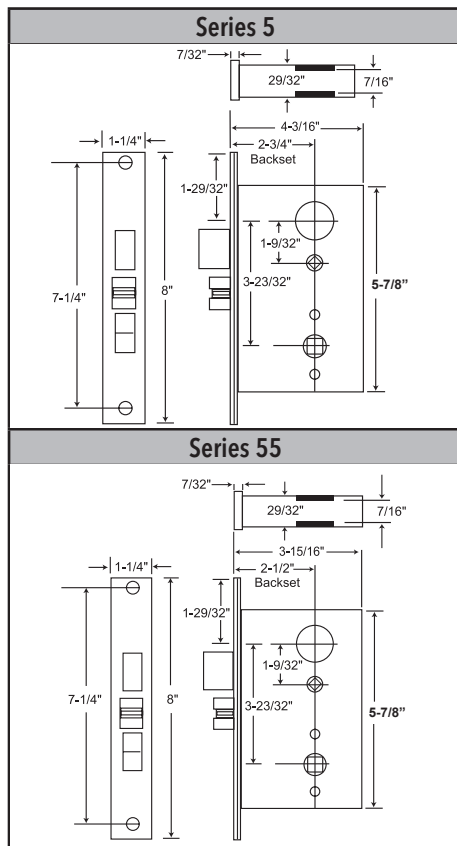

OPTIONS	CODE	PRICE
1-1/16" x 7-5/8" front	T	17.00
1-1/16" x 7-3/4" front	V	17.00
1-1/16" x 8" front	Q	17.00
Lever override guard outside (Series 5)	B1	28.00
Lever override guard both sides	B2	40.00
Lever support springs w- 5/16" hubs	B4	13.00
Hubs with hollow spacer (Series 55)	B6	12.00
Turnpiece hub on square	B8	8.00
Screws with Dust Box	B10	NC
Solid latch for electric strike	E1	13.00
Hold open latch	E2	24.00
Lead-lined mortise lock	F1	206.00
4-7/8" Strikes: 1 Left / 1 Right	S6	9.00
Request to exit switch (Series 5)	W10	101.00

CYLINDER CAMS REQUIRED	
Locks w/o deadbolt	2101 Straight Cam
Locks w/deadbolt	2102 Cloverleaf Cam
G function (ext. only)	2106 "G" Cam
G function (int. only)	2105 "J" Cam
J function	2105 "J" Cam

* 55 Series Lock Bodies are not available in autoreverse and electrified functions EL and EU.

Standard Features		Grade 1 for Knobs & Levers	
<ul style="list-style-type: none"> Backset: 5 Series 2-3/4"; 55 Series 2-1/2" Bolt throw: Stainless steel full 1" throw Latch throw: 3/4" (anti-friction) Auxiliary latch: 1/2" throw Case: Stamped steel .090 thick, Zinc dichromate finish Front: 1-1/4" x 8", Adjustable bevel Hubs: Steel, 9/32" on diamond 5/16" on square w/security separator 		Series 5 • 2-3/4" Backset Series 55 • 2-1/2" Backset BHMA CERTIFIED UL LISTED	
MARKS #		FUNCTION	ANSI #
		FINISH GROUPS	
		3, 32D	10, 10B, 32
KEYED SINGLE CYLINDER, NO DEADBOLT			
D	OFFICE / VESTIBULE		
DW	VESTIBULE		
E, Q, QH	OFFICE	F04	
K	OFFICE	F04	
EW	STOREROOM	F07	208.00
J	CLASSROOM	F05	272.30
JM, JR	HOSPITAL (HOLDBACK)	F06	
GL	INST. PRIVACY	F26	
MT	ArchiTech		751.93
EL*	⚡ ELECTRICALLY LOCKED*		569.52
EU*		ELECTRICALLY UNLOCKED*	581.99
KEYED SINGLE CYLINDER, WITH DEADBOLT			
A	ENTRANCE	F08, F10	
B	ENTRANCE	F21	
F	DORMITORY	F12	218.50
FS	DORMITORY		
FW	DORMITORY	F13	
FD	APARTMENT	F20	
AD		F27	234.24
H	HOTEL	F15	246.70
LH	SPEC. PRIVACY		
KEYED DOUBLE CYLINDER, NO DEADBOLT			
G	ENTRANCE	F09	
GC	INTRUDER LATCHBOLT	F32	
GG	CLASSROOM SECURITY		239.49
GR	CLASSROOM SECURITY w/HOLDBACK		251.30
WW	INSTITUTION	F30	
KEYED DOUBLE CYLINDER, WITH DEADBOLT			
AC	ENTRANCE	F35	
C	STOREROOM	F14	
FC	INTRUDER DEADBOLT	F34	239.49
FA	DORMITORY	F11	
FX	DORMITORY	F33	
KEYLESS			
N	PASSAGE		171.25
L	BATHROOM	F02	
LF	PRIVACY	F19	218.50
LJ	PRIVACY	F19	230.30
EX	EXIT	F31	
MORTISE LOCK BODIES ARE PACKED 6 PER CASE			
* Electrified Functions 5 SERIES ONLY: 2-3/4" Backset ONLY: 100% Duty Cycle 24V/DC, 12V/DC supplied with bridge rectifier (350 ma)			

Mortise Parts, Trim

MORTISE LOCK BODIES

Mortise Parts, Trim

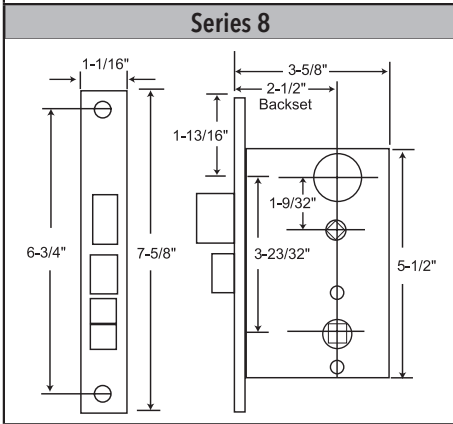
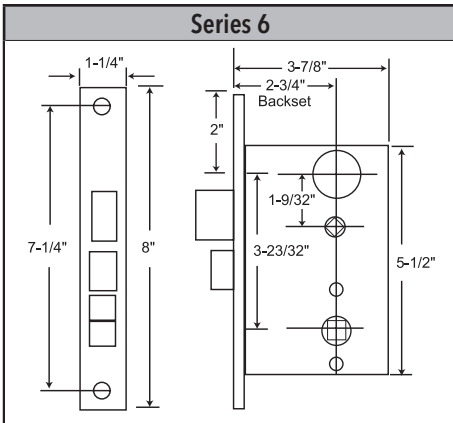

OPTIONS	CODE	PRICE
1-1/16" x 7-5/8" front	T	17.00
1-1/4" x 10" front, (A function, US 4 only), no mounting holes	U	69.00
1" x 7-1/8" front, (US 4 only)	W	NC
1-1/4" x 8" front	X	16.00
1-1/4" x 8-5/8" front (A function, US 4 only)	Y	69.00
Screws with Dust Box	B10	NC
Solid latch for electric strike	E1	13.00
4-7/8" Strikes: 1 Left / 1 Right	S6	9.00
Front 1" x 8"	Z	16.00

CYLINDER CAMS REQUIRED	
All Functions	2101 Straight Cam

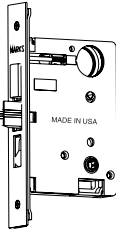
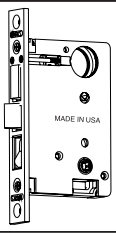
Series 6		Standard Features		Grade 2 for Handlesets Series 6 2-3/4" Backset Series 8 2-1/2" Backset	
		<ul style="list-style-type: none"> Backset: 2-3/4" Bolt throw: Cast alloy full 1" throw Latch throw: 5/8" (anti-friction) Case: High pressure cast Zamac, baked enamel finish Front: 1-1/4" x 8", Flat or 3° bevel Hubs: 9/32" (7.2mm) on square 			
Series 8		Standard Features		FINISH GROUPS	
		<ul style="list-style-type: none"> Backset: 2-1/2" Bolt throw: Cast alloy full 1" throw Latch throw: Solid brass 1/2" throw, reversible Case: High pressure cast Zamac, baked enamel finish Front: 1-1/16" x 7-5/8", Flat or 3° bevel Hubs: 9/32" on square 			
MARKS #	FUNCTION	ANSI #	3, 32D	10, 10B, 32	
KEYED SINGLE CYLINDER, NO DEADBOLT					
DW	VESTIBULE		211.28	223.08	
KEYED SINGLE CYLINDER, WITH DEADBOLT					
A	ENTRANCE	F08, F10	219.80	230.96	
B	ENTRANCE	F21			
F	DORMITORY	F12			
KEYED DOUBLE CYLINDER, WITH DEADBOLT					
AC	ENTRANCE	F35	230.30	242.12	
C	STORE DOOR "B BODY"	F25			
SO	STORE DOOR	F25			
MORTISE LOCK BODIES ARE PACKED 6 PER CASE					

MORTISE LOCK BODIES

Mortise Parts, Trim

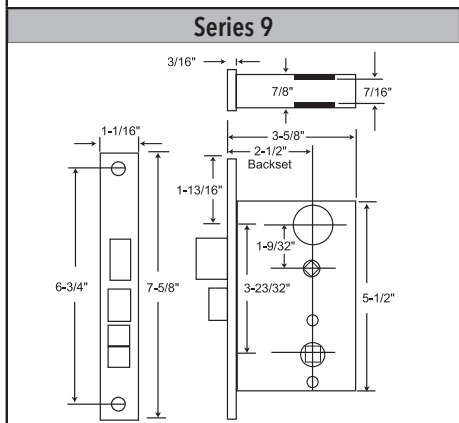
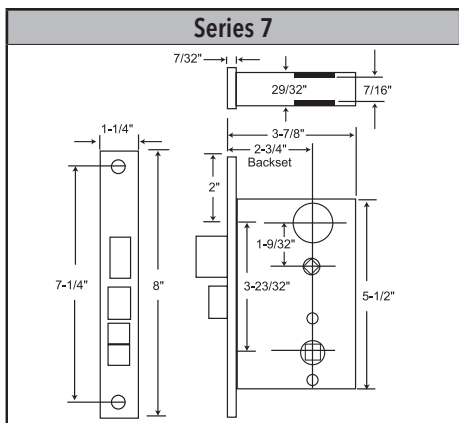

OPTIONS	CODE	PRICE
1-1/16" x 7-5/8" front	T	17.00
1-1/4" x 10" front, (A function, US 4 only), no mounting holes	U	69.00
1" x 7-1/8" front, (US 4 only)	W	NC
1-1/4" x 8" front	X	16.00
1-1/4" x 8-5/8" front (A function, US 4 only)	Y	69.00
1-1/16" x 8"	Q	17.00
Pin and lever springs	B5	24.00
Screws with Dust Box	B10	NC
Solid latch for electric strike	E1	13.00
4-7/8" Strikes: 1 Left / 1 Right	S6	9.00
Front 1" x 8"	Z	16.00

CYLINDER CAMS REQUIRED	
All functions	2101 Straight Cam

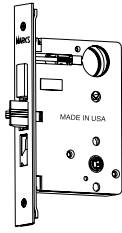
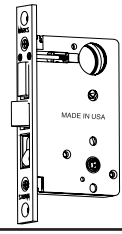
Series 7		Standard Features		Grade 2 for Knobs & Levers Series 7 2-3/4" Backset Series 9 2-1/2" Backset	
		<ul style="list-style-type: none"> Backset: 2-3/4" Bolt throw: Cast alloy full 1" throw Latch throw: 5/8" (anti-friction) Case: High pressure cast Zamac, baked enamel finish Front: 1-1/4" x 8", Flat or 3° bevel Hubs: 9/32" on square steel, w/ security separator 			
		<ul style="list-style-type: none"> Backset: 2-1/2" Bolt throw: Cast alloy full 1" throw Latch throw: Solid brass 1/2" throw, reversible Case: High pressure cast Zamac, baked enamel finish Front: 1-1/16" x 7-5/8", Flat or 3° bevel Hubs: 9/32" on square steel, w/ security separator 			
MARKS #	FUNCTION	ANSI #	FINISH GROUPS		
			3, 32D	10, 10B, 32	
KEYED SINGLE CYLINDER, NO DEADBOLT					
D	OFFICE / VESTIBULE		187.00	198.81	
DW	VESTIBULE				
KEYED SINGLE CYLINDER, WITH DEADBOLT					
A	ENTRANCE	F08, F10	197.50	208.00	
B	ENTRANCE	F21			
F	DORMITORY	F12			
FS	DORMITORY				
FW	DORMITORY	F13			
KEYED DOUBLE CYLINDER, WITH DEADBOLT					
AC	ENTRANCE	F35	217.84	228.99	
C	STOREROOM	F14			
FA	DORMITORY	F11			
FX	DORMITORY	F33			
KEYLESS					
N	PASSAGE	F01	150.25	161.41	
L	BATHROOM	F02	197.50	208.00	
LF	PRIVACY	F19			
MORTISE LOCK BODIES ARE PACKED 6 PER CASE					

MORTISE DEADLOCKS

Mortise Parts, Trim

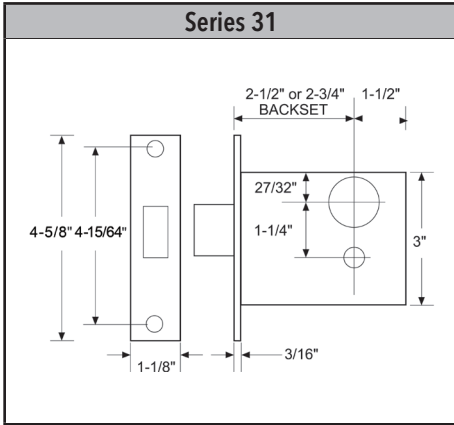

OPTIONS	CODE	PRICE
Security Strike: 4-7/8" x 1-1/4"	S4	12.00

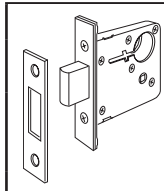

- Standard Features**
- Backset: Series 31: 2-3/4"
 - Bolt throw: 1" stainless steel with hardened roll pins
 - Case: Stamped Steel, Grade 1
 - Front: 1-1/16" x 4-5/8" adjustable bevel
 - Cylinder: Solid brass cylinder, 6-pin, "C" keyway, 2 keys
 - Strike: #4035 (Included) 1-1/8" x 3-1/8"
 - Strike: #4035-1 (Optional) 1-1/8" x 3-1/2"

Series 31
2-3/4" Backset



MARKS #	FUNCTION	ANSI #	FINISH GROUPS	
			3, 32D	10, 10B, 26, 32
-	LOCK ONLY	-	122.04	198.81
K, 31K	CYLINDER x TURNPIECE	E06071	161.41	208.00
L, 31L	COMMUNICATING SINGLE CYL.	E06081	144.35	228.99
M, 31M	DOUBLE CYLINDER	E06061	163.38	208.00
S, 31S	CLASSROOM (Specify Handing)	E06091	183.06	208.00
X, 31X	TURNPIECE ONLY		129.26	251.30

MORTISE LOCK BODIES ARE PACKED 6 PER CASE

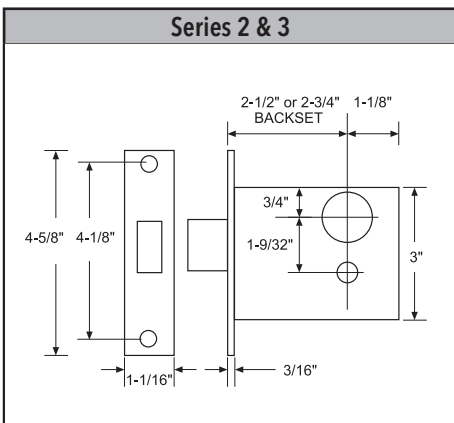

OPTIONS	CODE	PRICE
1-1/16" x 5-5/8" front	R	29.00

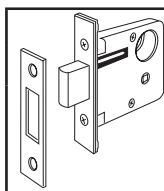

- Standard Features**
- Backset: Series 2: 2-1/2"; Series 3: 2-3/4"
 - Bolt throw: 1"
 - Case: High pressure cast
 - Front: 1-1/16" x 4-5/8" flat or 3° bevel
 - Cylinder: Solid brass cylinder, 6-pin, "C" keyway, 2 keys
 - Strike: #4035 Included

Series 2 • 2-1/2" Backset
Series 3 • 2-3/4" Backset



MARKS #	FUNCTION	ANSI #	FINISH GROUPS	
			3, 32D	10, 10B, 26, 32
-	LOCK ONLY	-	85.96	101.04
K, 2K, 3K	CYLINDER x TURNPIECE	E06071	125.98	139.10
L, 2L, 3L	COMMUNICATING SINGLE CYL.	E06081	110.23	125.98
M, 2M, 3M	DOUBLE CYLINDER	E06061	132.54	146.32
S, 2S, 3S	CLASSROOM (Specify Handing)	E06091	145.01	163.38
X, 2X, 3X	TURNPIECE ONLY		92.52	106.29

MORTISE LOCK BODIES ARE PACKED 6 PER CASE

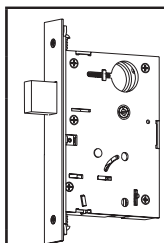
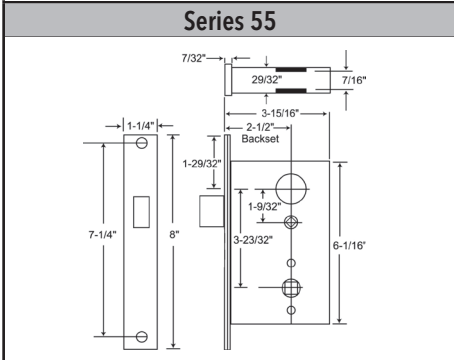
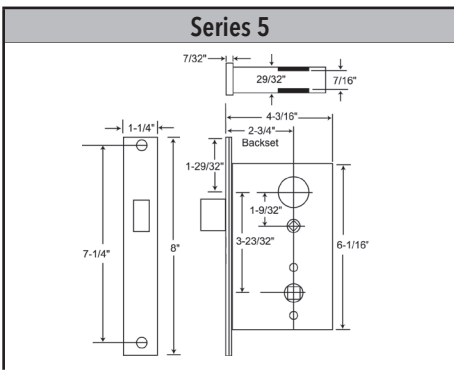

- Standard Features**
- Backset: Series 5: 2-3/4"; Series 55: 2-1/2"
 - Bolt throw: Stainless steel full 1" throw
 - Case: Stamped steel .090 thick, Zinc dichromate finish
 - Front: 1-1/4" x 8" Adjustable bevel

Series 5 • 2-3/4" Backset
Series 55 • 2-1/2" Backset

























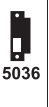









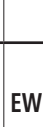





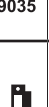

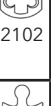
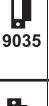
MARKS #	FUNCTION	ANSI #	FINISH GROUPS	
			3, 32D	10, 10B, 32
T, 5T	DOUBLE CYLINDER	F16	246.05	254.58
P, 5P	CYLINDER x TURNPIECE	F17	225.71	240.80
S, 5S	SINGLE CYLINDER*	F18	208.00	224.40
SC, 5SC	CLASSROOM*	F29	240.80	254.58

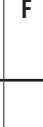











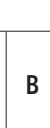





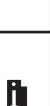

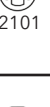
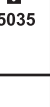
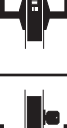
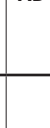
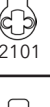
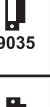

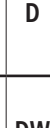
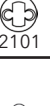
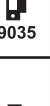

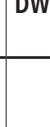
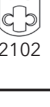
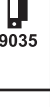
MORTISE LOCK BODIES ARE PACKED 6 PER CASE
*NOTE: Specify handing on "S" and "SC" functions

OPTIONS	CODE	PRICE
1-1/16" x 7-5/8" front	T	17.00
1-1/16" x 7-3/4" front	V	17.00
1" x 1/16" x 8"	Q	17.00
Lead lined mortise lock	F1	206.00

MORTISE LOCKSET FUNCTIONS

ANSI #	TYPE	MARKS FUNCTION	ANSI #	TYPE	MARKS FUNCTION	ANSI #	TYPE	MARKS FUNCTION	ANSI #	TYPE	MARKS FUNCTION
F01	Non-Keyed	N	F10	Single Cylinder	A	F19	Non-Keyed	LF	F29	Deadbolt	SC
F02	Non-Keyed	L	F11	Double Cylinder	FA	F20	Single Cylinder	FD	F30	Double Cylinder	WW
F04	Single Cylinder	E	F12	Single Cylinder	F	F21	Single Cylinder	B	F31	Non-Keyed	EX
F05	Single Cylinder	J	F13	Single Cylinder	FW	F22	Non-Keyed	LJ	F32	Double Cylinder	GC
F06	Single Cylinder	JM	F14	Double Cylinder	C	F24	Double Cylinder	G	F33	Double Cylinder	FX
F06	Single Cylinder	JR	F15	Single Cylinder	H	F25	Double Cylinder	C	F34	Double Cylinder	FC
F07	Single Cylinder	EW	F16	Deadbolt	T	F25	Double Cylinder	SO	F35	Double Cylinder	AC
F08	Single Cylinder	A	F17	Deadbolt	P	F26	Single Cylinder	GL			
F09	Double Cylinder	G	F18	Deadbolt	S	F27	Auto Deadbolt	AD			

SINGLE CYLINDER FUNCTIONS				
ANSI #	Cam	Strike	Marks Function	
F04: OFFICE Latch by knob/lever either side except when outside knob/lever locked by stop-button in front; then by key outside. Auxiliary latch deadlocks latch. Inside always open.				
	2101	5036		E
F04: OFFICE Latch by knob/lever either side except when outside knob/lever locked by turn piece inside; then by key outside. Auxiliary latch deadlocks latch. Inside always open.				
	2105	5036		K
F05: CLASSROOM Latch by knob/lever either side except when outside knob/lever locked by key. When locked, latch bolt retracted by key. Inside always open. Auxiliary latch deadlocks latch.				
	2105	5036		J
F06: HOLDBACK "A" Latch by knob/lever either side except when outside knob/lever locked or unlocked by key. Auxiliary latch deadlocks latch. Inside always open. Inside knob/lever unlocks outside lever. Latch bolt can be locked in retracted position by locking inside hub. Can be used with blank outside trim.				
	2105	5036		JM
F06: HOLDBACK "B" Latch by knob/lever either side except when outside knob/lever locked or unlocked by key. Auxiliary latch deadlocks latch. Inside always open. Inside knob/lever will not unlock outside knob/lever. Latch bolt can be locked in retracted position by locking outside hub. Can not be used with blank outside trim.				
	2105	5036		JR
F07: STOREROOM Latch by knob/lever inside, key outside. Outside knob/lever always rigid. Auxiliary latch deadlocks latch. Inside always open.				
	2101	5036		EW
F08, F10: ENTRANCE Latch by knob/lever either side except when outside locked by stop-button; then by key outside, knob/lever inside. Deadbolt by key outside, turnpiece inside. Deadbolt deadlocks latch.				
	2102	9035		A
F12: DORMITORY Latch by knob/lever either side except when outside knob/lever locked by stop-button or projected deadbolt. Deadbolt by turnpiece inside. Inside knob/lever retracts latch and deadbolt simultaneously, leaving outside locked. Deadbolt deadlocks latch.				
	2102	9035		F
F13: DORMITORY Latch by knob/lever either side except when projected deadbolt locks outside knob/lever and deadlocks latch. Deadbolt and latch by key outside. Deadbolt by turnpiece inside. Inside knob/lever retracts latch and deadbolt simultaneously, automatically unlocking outside knob/lever.				
	2102	9035		FW
F15: HOTEL Inside knob/lever always free, outside rigid. Latch by knob/lever inside, key outside. (When deadbolt projected by turnpiece all keys are shut out except emergency key). Inside knob/lever retracts deadbolt and latch simultaneously. Auxiliary latch or deadbolt deadlocks latch. Indicator available.				
	2102	5035		H
F20: APARTMENT Latch by knob/lever either side except when outside locked by stop-button or projected deadbolt. Latch deadlocked by auxiliary latch or deadbolt. Deadbolt and latch by key outside. Deadbolt by turnpiece inside. Inside knob/lever retracts latch & deadbolt simultaneously, leaving outside locked.				
	2102	5035		FD

SINGLE CYLINDER FUNCTIONS				
ANSI #	Cam	Strike	Marks Function	
F21: ENTRANCE Latch by knob/lever either side. Deadbolt by key outside, turnpiece inside. Deadbolt deadlocks latch.				
	2102	9035		B
F26: INSTITUTIONAL PRIVACY Latch by knob/lever either side except when outside knob/lever locked by inside turn piece. Latch deadlocked by auxiliary latch. Key outside opens latch. When outside locked, inside knob/lever retracts latch, automatically unlocking outside knob/lever.				
	2105	5036		GL
F27: Auto Deadbolt Depressing auxiliary latch projects deadbolt and deadlocks latch. Remains locked even if auxiliary latch is extended. Inside knob/lever retracts both bolts simultaneously. When outside is locked, both bolts are retracted by override key with outside knob/lever.				
	2101	5035		AD
OFFICE VESTIBULE: Latch by knob/lever either side except when outside knob/lever locked by stop-button in front; then by key outside.				
	2101	9035		D
VESTIBULE: Latch by knob/lever inside, key outside. Outside knob/lever always rigid.				
	2101	9035		DW
DORMITORY: Latch by knob/lever inside. Outside knob/lever always rigid. Deadbolt and latch by key outside. Deadbolt by turnpiece inside. When deadbolt is projected, latch is deadlocked. Inside knob/lever retracts latch and deadbolt simultaneously.				
	2102	9035		FS
SPECIAL PRIVACY: Inside knob/lever always free, outside rigid. Latch by knob/lever inside, key outside. Deadbolt by turnpiece inside, emergency release outside. Inside knob/lever retracts deadbolt and latch simultaneously. Auxiliary latch deadlocks latch.				
	2102	5035		LH
ELECTRIFIED FUNCTIONS				
ELECTRICALLY LOCKED (Fail Safe): Outside always locked electrically. Open by key outside, switch or loss of power. Auxiliary latch deadlocks latch. Inside always open.				
	2101	5036		EL
ELECTRICALLY UNLOCKED (Fail Secure): Outside always locked until unlocked by key or electrically energized. Auxiliary latch deadlocks latch. Inside always open.				
	2101	5036		EU

Mortise Parts, Trim







MORTISE LOCKSET FUNCTIONS

DOUBLE CYLINDER FUNCTIONS				
ANSI #	Cam	Strike	Marks Function	
F09: ENTRANCE Latch by knob/lever either side except when outside knob/lever locked by key inside, latch retracted by key outside. Outside remains locked. Auxiliary latch deadlocks latch.			I/S	O/S
F11: DORMITORY Latch by knob/lever either side except when outside knob/lever locked by stop-button or projected deadbolt. Deadbolt by key either side. Inside knob/lever retracts latch and deadbolt simultaneously leaving outside locked. Deadbolt deadlocks latch.				
F14: STOREROOM Latch by knob/lever either side. Deadbolt by key either side. Deadbolt deadlocks latch.				
F25: STOREROOM "B" Body Latch by thumbpiece either side. Deadbolt by key either side.				
F25: STOREROOM Latch by thumbpiece either side except when outside thumbpiece locked by stop-button in front; then by key outside. Deadbolt by key both sides. Deadbolt deadlocks latch.				
F30: INSTITUTION Both knob/levers rigid. Auxiliary latch deadlocks latch. Latch by key either side.				
F32: INTRUDER LATCH BOLT Latch by knob/lever either side except when outside knob/lever is locked from inside or outside by key. Latch operated by key from inside or outside. Auxiliary latch, deadlocks latch. Inside always open.				
CLASSROOM SECURITY Latch bolt retracted by knob/lever from either side unless outside is locked by key from either side. Auxiliary latch deadlocks latch bolt when door is locked. Inside knob/lever is always free for immediate egress.				
CLASSROOM SECURITY Latch bolt retracted by knob/lever from either side except when locked by key from either side. Auxiliary latch deadlocks latch				
CLASSROOM SECURITY Latch by lever either side except when outside lever is locked or unlocked by key from either side. With outside locked, exterior key will retract the latch allowing the outside to remain locked. Inside always free for egress. Auxiliary latch deadlocks latch.				
CLASSROOM SECURITY w/HOLDBACK Latch bolt retracted by knob/lever from either side unless outside is locked by key from either side. When locked, latch bolt retracted by key outside or knob/lever inside. Auxiliary latch deadlocks latch bolt when door is locked. Depress inside knob/lever and turn key 360° for holdback feature. Inside knob/lever always free for immediate egress.				
DEADLOCK Latch by knob/lever either side. Deadbolt by key either side; latch remained unlocked at all times. Note: With this function deadbolt protrusion is 13/16				
F33: DORMITORY Latch by knob/lever either side except when projected deadbolt locks outside knob/lever and deadlocks latch. Deadbolt and latch by key either side. Inside knob/lever retracts latch and deadbolt simultaneously, automatically unlocking outside knob/lever.				

DOUBLE CYLINDER FUNCTIONS (Con't)				
ANSI #	Cam	Strike	Marks Function	
F33: DORMITORY Latch by knob/lever either side except when projected deadbolt locks outside knob/lever and deadlocks latch. Deadbolt and latch by key either side. Inside knob/lever retracts latch and deadbolt simultaneously, automatically unlocking outside knob/lever.				
F35: STORE DOOR Latch by knob/lever either side except when outside knob/lever locked by stop-button in front; then by key outside. Deadbolt by key either side. Deadbolt deadlocks latch.				
NON-KEYED FUNCTIONS				
ANSI #		Strike	Marks Function	
F01: PASSAGE Latch by knob/lever either side.			I/S	O/S
F02: BATHROOM* Latch by knob/lever either side. Deadbolt by turnpiece inside. Deadbolt deadlocks latch. To unlock from outside, remove emergency button, insert emergency key in access hole & turn. Optional coinkey assembly available.				
F19: PRIVACY* Latch by knob/lever either side except when projected deadbolt locks outside knob/lever and deadlocks latch. Deadbolt by turnpiece inside. Inside knob/lever retracts latch and deadbolt simultaneously, automatically unlocking outside knob/lever. To unlock from outside, remove emergency button, insert emergency key in access hole and turn. Optional coinkey assembly available.				
F22: PRIVACY Latch by knob/lever either side except when outside knob/lever is locked by inside turnpiece. Turning inside knob/lever or closing door unlocks outside lever. To unlock from outside, remove emergency button, insert emergency key in access hole and turn. Optional coinkey assembly available.				
F31: EXIT Latch by knob/lever inside, no trim outside. Auxiliary latch deadlocks latch. None removable blank trim: F26 option				
DEADBOLT FUNCTIONS				
F16: DEADLOCK Deadbolt by key either side.				
F17: DEADLOCK Deadbolt by key outside and turnpiece inside.				
F18: DEADLOCK Deadbolt by key one side only.				
F29: DEADLOCK Deadbolt by key outside. Inside turnpiece will retract but will not project deadbolt.				
DEADLOCK FUNCTIONS				
E06072: CYLINDER BY TURNPIECE Deadbolt by inside turnpiece or outside key.				
E06082: COMMUNICATING SINGLE CYLINDER* Deadbolt by key from one side only.				
E06062: DOUBLE CYLINDER Deadbolt by key either side.				
E06092: CLASSROOM Deadbolt by outside key. Turnpiece will retract but not project deadbolt.				
TURNPIECE Deadbolt by inside turnpiece.				

*PRIVACY INDICATOR AVAILABLE

MORTISE LOCKSET PARTS RK, RL

ROSES	RR: 2-9/16" dia.	RW: 2-9/16" dia.	RQ: 2-1/4" dia.	RS: 2-1/4" dia.	RX: 2-1/2" sq.	*RK: 2-1/2" sq.	*RL: 2-1/2" sq.
					 Wrought	 Forged	 Forged

Knob / Rose Kits

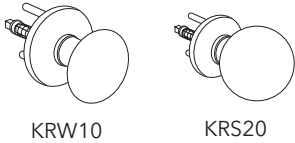

ROSE WITH RING	PLAIN ROSE	SMALL ROSE W/RING	SMALL ROSE	DESCRIPTION	FINISH GROUPS					ROSE RK*
					3	10, 10B	15	26	32D	
KRR10	KRW10	KRQ10	KRS10	Round knob/ball assembly	129.31	-	-	-	123.47	+77
KRR20	KRW20	KRQ20	KRS20	Ball knob/ball assembly	129.31	-	-	-	123.47	
					NO FINISH					

Complete knob/rose assemblies both sides (includes spindles).

Lever / Rose Kits

* Specify handing

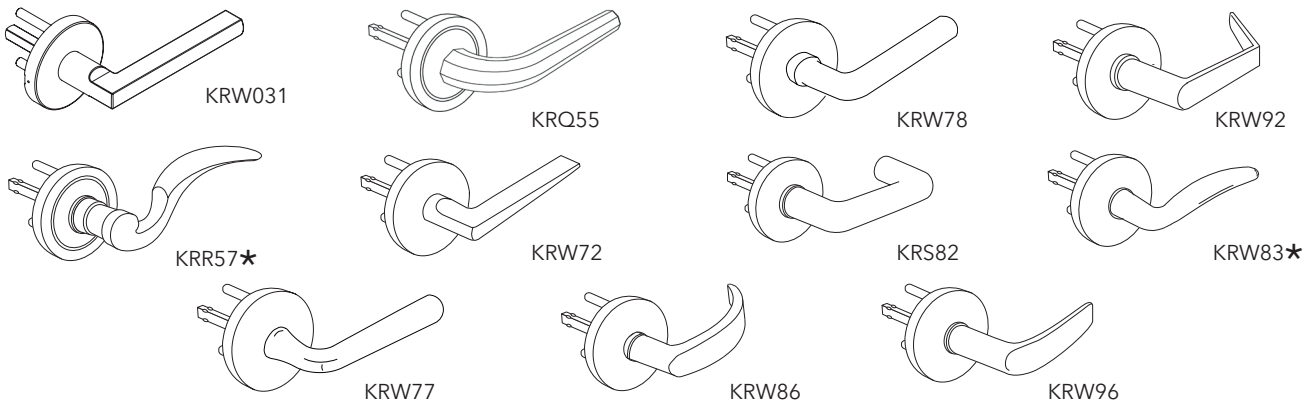

PART #		DESCRIPTION	FINISH GROUPS						ROSE RK, RL	ROSE RX
ROSE WITH RING RR	SMALL ROSE WITH RING RQ		3	4	26D	15	10, 10B, 10, 19, 26	32D		
		Complete lever/rose assemblies both sides (includes spindles).								
KRR57	KRQ57	Monaco lever/rose kit	140.41	210.62	210.62	210.62	-	-		
KRR55	KRQ55	Brompton lever/rose kit	140.41	210.62	210.62	210.62	-	-		
		Complete lever/rose assemblies both sides (includes spindles).								
PLAIN ROSE RW	SMALL ROSE RS								ROSE RK, RL	ROSE RX
KRW031	KRS031	Copa lever/rose kit	210.62	210.62	-	210.62	210.62	210.62	+63 FOR ALL FINISHES	+20 FOR ALL FINISHES
KRW72	KRS72	Towne lever/rose kit	210.62	210.62	210.62	210.62	238.83	-		
KRW77	KRS77	Maxwell lever/rose kit	210.62	210.62	210.62	210.62	238.83	213.72		
KRW78	KRS78	Omni lever/rose kit	210.62	210.62	210.62	210.62	238.83	213.72		
KRW82	KRS82	Plaza lever/rose kit	210.62	210.62	210.62	210.62	238.83	213.72		
KRW83	KRS83	Dayton lever/rose kit	210.62	210.62	210.62	210.62	238.83	213.72		
KRW86	KRS86	Crescent lever/rose kit	210.62	210.62	210.62	210.62	238.83	-		
KRW92	KRS92	American lever/rose kit	210.62	210.62	210.62	210.62	238.83	213.72		
KRW96	KRS96	Titan lever/rose kit	210.62	210.62	210.62	210.62	238.83	213.72		

Mortise Parts, Trim

MORTISE LOCKSET PARTS

Dummy Cylinder, Collars & Turnpieces

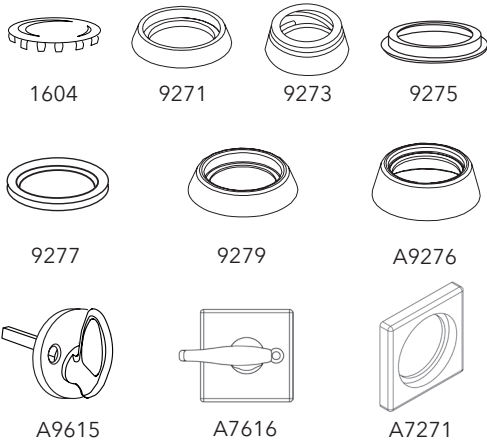

PART #	DESCRIPTION	FINISH GROUPS				
		3, 26D	4	10, 10B, 26	32	32D
1604	Emergency hole cover	7.69	-	-	-	-
9271	Tapered collar, solid brass, 5/16" high	17.08	-	18.47	21.18	18.47
9273	Spring collar, 7/16" high	11.54	-	-	-	-
9275	Mortise spacer, wrought brass, 1/8" high	6.93	-	-	-	-
9277	Plastic spacer ring, 1/16"	5.39	-	-	-	-
9279	Tapered collar, wrought brass, 3/8" high	13.08	-	16.93	14.62	13.09
A7271	Square cylinder collar, 1-3/4" x 5/16"	28.47	-	28.47	28.47	50.02
A7616	Square Turnpiece Rose	45.40	59.25	52.33	52.33	59.24
A9276	Collar, wrought brass w/insert, 1/2" high	16.93	-	23.08	23.08	23.00
A9615	Turnpiece	36.17	50.79	43.09	50.79	43.09

Mortise Parts, Trim

Strikes

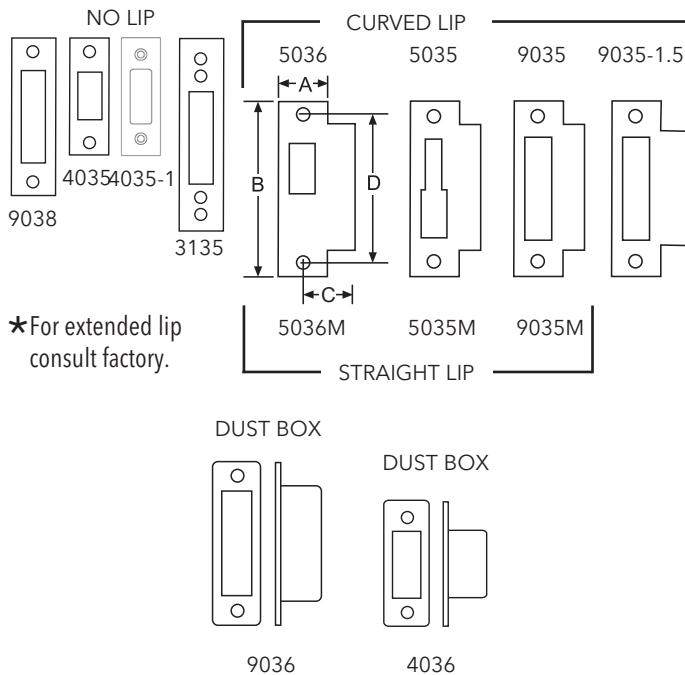

TYPE	PART #	A	B	C*	D	FINISH GROUPS	
						S3	3, 10, 10B, 32, 32D
No Lip	4035	1-1/8"	3-1/8"	-	-	6.42	11.09
	4035-1	1-1/8"	3-1/2"	3-1/2"	2-1/2"		
	9038	1-1/8"	4-7/8"	-	2-1/2"	7.00	-
	3135	1-1/4"	4-7/8"	-	-	-	14.59
Curved Lip	5035 †	1-1/4"	4-7/8"	1-1/4"	4-1/8"	-	15.76
	5036 †	1-1/4"	4-7/8"	1-1/4"	4-1/8"	-	17.51
	9035	1-1/4"	4-7/8"	1-1/4"	4-1/8"	6.42	17.51
	9035-1.5	1-1/4"	4-7/8"	1-1/2"	4-1/8"	-	24.51
Straight Lip	5035M †	1-1/4"	4-7/8"	7/8"	4-1/8"	-	19.26
	5036M †	1-1/4"	4-7/8"	7/8"	4-1/8"	-	19.26
	9035M	1-1/4"	4-7/8"	7/8"	4-1/8"	-	19.26
Dust Box	9036	Dust box for 9038 strike, plastic				6.42	-
	4036	Dust box for 4035 strike, plastic				5.25	-

† Specify handing.
 Extended lip strikes from 1-1/4" - 2", Add \$16.
 *Extended lip strikes over 2", consult factory.

Spindles

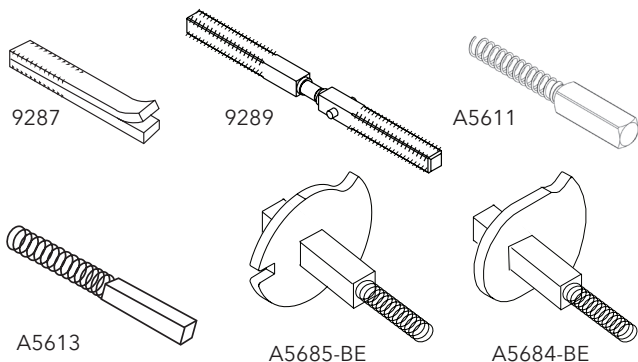

PART #	DESCRIPTION	
9287	2-1/2" LONG, HOOK SPINDLE, 2 PIECE	11.67
9289	4-3/4" LONG, SWIVEL SPINDLE	11.67
A5611	SPINDLE/SPRING ASSEMBLY FOR LEVERS, 5/16", 1" L	11.67
A5613	SPINDLE/SPRING ASSEMBLY FOR LEVERS, 5/16", 1-5/8" L	11.67
A5685-BE	CAM/SPINDLE SPRING ASSEMBLY EXTERIOR	19.26
A5684-BE	CAM/SPINDLE SPRING ASSEMBLY INTERIOR	19.26

MORTISE LOCKSET PARTS

Indicators

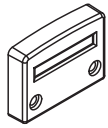

SKA200

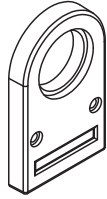

SKA200-CK
(Rose Trims Only)

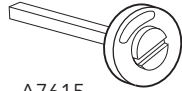

A7615
ONLY 32D

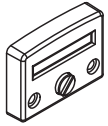

SKA210



SKA210-CK
(Rose Trims Only)

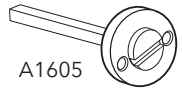

A1605

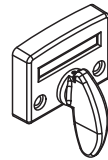

SKA200-TP



SKA210-TP
(Rose Trims Only)



A9119H

PART #	DESCRIPTION	FINISH GROUPS					Option
		3, 26D	4	10,10B, 19, 26	32	32D	
A1605	Emergency coin key	51.07	51.07	51.07	51.07	-	A15
A7615	Occupancy indicator, coin key round		-	-	-	41.56	A17
SKA100	Occupancy indicator, coin key round LJ		80.74	-	-	-	A17
A9119H	Occupancy indicator, teardrop for rose trim coin key		80.74	-	-	-	A42
A9119	Occupancy indicator, teardrop for rose trim		80.74	-	-	-	A40
SKA200	Occupancy indicator, wo/cyl prep - Handed		-	-	-	204.28	A50
SKA200-CK	Occupancy indicator, w/cyl prep - Handed		-	-	-	204.28	A51
SKA210	Occupancy indicator coin key, wo/cyl prep - Handed		-	-	-	204.28	A53
SKA210-CK	Occupancy indicator coin key, w/cyl prep - Handed		-	-	-	204.28	A54
SKA200TP	Occupancy indicator t-turn, wo/cyl prep - Handed		-	-	-	204.28	A52
SKA210TP	Occupancy indicator t-turn, w/cyl prep - Handed		-	-	-	233.47	A55

Mortise Parts, Trim

TRIM LOCK PARTS





How to Order Example
for Knob & Lever Assemblies

DR	02	-	30	/	15
1. Plate/Rose Design	2. Trim Description	Dash	3. Knob/Lever Design	Slash	4. Finish











Mortise Parts, Trim

PLATE/ROSE DESIGN		TRIM DESCRIPTION	KNOB DESIGN	FINISH
___ CL	___ RR	___ 01 Outside knob/lever/cylinder	___ 10	___ 3
___ CP	___ RW	___ 02 Inside knob/lever/turnpiece	___ 20	___ 4
___ CR	___ RQ	___ 03 Inside knob/lever/cylinder		___ 10
___ DR	___ RS	___ 04 Inside knob/lever only		___ 10B
___ NY	___ RX	___ 05 Outside cylinder only		___ 15
___ NS		___ 06 Outside knob/lever/emergency coinkey		___ 26
		___ 07 Outside hotel		___ 26D
		___ 08 Outside knob/lever only		___ 32D
			LEVER DESIGN	___ Special
			___ 44	___ 32
			___ 55	
			___ 57	
			___ 72	
			___ 77	
			___ 78	
			___ 82	
			___ 83	
			___ 86	
			___ 92	
			___ 96	
			___ 031	
			___ 037A	
			___ 002	

TRIM LOCK PARTS

PLATE/ROSE DESIGN		3	19	10	10B	15	26D	32D
CLASSIC CL		-	-	-	-	-	-	63.10
CAPITOL CP		102.35	100.81	100.81	100.81	-	-	93.88
CROWN CR		129.28	147.75	147.75	147.75	129.28	129.28	129.28
DRAKE DR		156.22	170.07	170.07	170.07	156.22	156.22	161.61
SCHOOL LA		-	-	-	-	-	-	147.75

TRIM LOCK PARTS

















PLATE/ROSE DESIGN		3	19	10	10B	15	26D	32D
NEW YORKER NY 10" PLATE		36.17	-	-	-	-	44.63	-
NEW YORKER NS 7" PLATE		26.35	-	-	-	-	36.17	-
2-9/16" DIA. ROSE W-RING RR		85.42	103.12	103.12	103.12	94.65	85.42	85.42
2-9/16" DIA. PLAIN ROSE RW		85.42	103.12	103.12	103.12	94.65	85.42	85.42
2-1/4" DIA. SMALL ROSE W-RING RQ		85.42	103.12	103.12	103.12	94.65	85.42	85.42
2-1/4" DIA. SMALL ROSE RS		85.42	103.12	103.12	103.12	94.65	85.42	85.42
2-1/2" SQ. SQUARE ROSE RX		85.42	103.12	103.12	103.12	94.65	85.42	85.42
2-1/2" SQ. SQUARE ROSE RK		143.13	159.29	159.29	159.29	151.60	143.13	143.13
SQUARE TURNPIECE ROSE A7616	OUTSIDE 	146.21	168.53	168.53	168.53	168.53	152.37	152.37
	INSIDE	46.94	52.33	52.33	52.33	52.33	52.33	52.33
2-1/2" SQ. SQUARE ROSE RL		152.37	168.53	168.53	168.53	168.53	152.37	152.37

Mortise Parts, Trim

TRIM LOCK PARTS

Knob / Lever Design

Mortise Parts, Trim

KNOB/LEVER	FINISH GROUPS									
	3	19	4	10	10B	15	26	26D	32D	
ROUND KNOB  10	76.19	-	-	93.11	93.11	-	93.11	93.11	76.18	
BALL KNOB  20	76.19	-	-	93.11	93.11	-	93.11	93.11	76.18	
METROPOLITAN LEVER  002	129.28	155.45	155.45	170.84	170.84	155.45	170.84	170.84	162.38	
COMMERCE LEVER  037A	129.28	155.45	155.45	170.84	170.84	155.45	170.84	170.84	162.38	
LUCIDA LEVER  47C	-	155.45	155.45	170.84	170.84	155.45	170.84	170.84	152.37	
COPA LEVER  031	129.28	155.45	155.45	170.84	170.84	155.45	170.84	170.84	-	
MONACO LEVER  57	155.45	155.45	155.45	170.84	170.84	155.45	170.84	170.84	-	
BROMPTON LEVER  55	155.45	155.45	155.45	170.84	170.84	155.45	170.84	170.84	-	
TOWNE LEVER  72	129.28	155.45	155.45	170.84	170.84	155.45	170.84	170.84	-	
MAXWELL LEVER  77	129.28	155.45	155.45	170.84	170.84	155.45	170.84	170.84	152.37	
OMNI LEVER  78	129.28	155.45	155.45	170.84	170.84	155.45	170.84	170.84	-	
PLAZA LEVER  82	129.28	155.45	155.45	170.84	170.84	155.45	170.84	170.84	152.37	
DAYTON LEVER  83	129.28	155.45	155.45	170.84	170.84	155.45	170.84	170.84	155.45	
CRESCENT LEVER  86	129.28	155.45	155.45	170.84	170.84	155.45	170.84	170.84	152.37	
AMERICAN LEVER  92	129.28	155.45	155.45	170.84	170.84	155.45	170.84	170.84	152.37	
TITAN LEVER  96	129.28	155.45	155.45	170.84	170.84	155.45	170.84	170.84	152.37	

HOW TO ORDER CYLINDRICAL LOCKSETS



How To Order Example for Cylindrical Locksets					
195	AB	/	26D	-	G3
<i>1. Lockset Series</i>	<i>2. Marks Function</i>	<i>Slash</i>	<i>3. Finish</i>	<i>Dash</i>	<i>4. Options</i>

1	SERIES
Cylindrical Locksets:	110, 110R, 210, 210R, 175, 175R, 195, 195R, 295, 295R, 495, 495R

2	CYLINDRICAL FUNCTIONS		
MARKS #	FUNCTION	ANSI #	
N	-	PASSAGE	F75
L	-	PRIVACY	F76
LK	-	HOSPITAL/PRIVACY	F76 MOD.
P	-	PATIO	F77
DC	RDC	COMMUNICATING	F80
A	RA	ENTRY	F81
B	RB	ENTRY	F82A
AQ	-	EXIT	F83
S	RS	CLASSROOM	F84
F	RF	STOREROOM	F86
DW	RDW	INSTITUTION	F87
DA	RDA	VESTIBULE	F88
FQ	-	EXIT	F89
T	RT	CORRIDOR	F90
TO	-	TIME OUT	
TK	-	HOSPITAL/PRIVACY	F90 MOD.
GB	RGB	STORE DOOR (95 SERIES ONLY)	F91
BS	-	SERVICE STATION LOCK	F92
H	-	HOTEL	F93
AB	RAB	ENTRANCE	F109
DB	RDB	CLASSRM. INTRUDER	F110
NB	-	COMMUNICATING PASSAGE	F111
FB	-	COMMUNICATING STOREROOM	F112
SB	RSB	COMMUNICATING CLASSROOM	F113
FEL	RFEL	ELECTRONICALLY LOCKED	
FEU	RFEU	ELECTRONICALLY UNLOCKED	
DUMMY TRIM			
DO		DUMMY TRIM OUTSIDE	
DT		FULL DUMMY	

4	OPTIONS		
TRIM MODIFICATIONS	CODE	PRICE	
Tactile knob/lever, coated ext. only	A1	38	
Tactile knob/lever, knurled	A4	38	
Tactile knob/lever, coated int. & ext.	A18	78	
DOOR THICKNESS	CODE	PRICE	
2" (50 mm)	D1	NC	
2-1/4" (57mm)	D2	48	
Over 2-3/8" - 4"	D9	409	
LATCH	CODE	PRICE	
2-3/4" backset, 1-1/8" x 2-1/4" face	E4	NC	
2-3/8" backset, 1" x 2-1/4" face	E6	NC	
5" backset, 9/16" throw, Gr. 1	E9	30	
3-3/4" backset, 9/16" throw, Gr. 1	E10	30	
2-3/8" backset, 1-1/8" x 2-1/4" face	E11	9	
2-3/4" backset, 1" x 2-1/4" face	E12	9	
TRIM CHANGES	CODE	PRICE	
Yale/Accentra conventional	F7	15	
Sargent conventional cylinder	F8	15	
Corbin Russwin conventional cylinder	F9	15	
Corbin Russwin 6 pin IC core	F12	22	
Corbin Russwin 7 pin IC core	F13	22	
Yale/Accentra 6 pin IC core	F14	15	
Yale/Accentra 7 pin IC core	F15	15	
Schlage 6 pin IC core	F19	15	
Sargent IC core	F20	15	
Medeco IC core large format	F21	15	
CYLINDER	CODE	PRICE	
Special optional keyway	G2	24	
Less cylinder	G3	Deduct 10	
STRIKE	CODE	PRICE	
4-7/8" ASA strike	S1	9	
2-3/4" "T" strike	S3	NC	

10 LINE GRADE 2 CYLINDRICAL KNOBSETS

BHMA™ CERTIFIED		ANSI-A156.2 • Grade 2 Plus 3 Hour Fire Rating		Series 110/110R • 2-3/8" Backset	Series 210/210R • 2-3/8" Backset
10 Series Knobsets Shown Below				Standard Features	
 				<ul style="list-style-type: none"> • Backset: 2-3/8" • Latch #1138, Front: 1" x 2-1/4"; Throw: 1/2"; Stainless steel nose • Knobs: 2-1/4" dia. (110) round; 2-3/16" dia. (210) ball • Roses: Adjustable both sides; Steel reinforced 2-3/4" dia. • Strike: #1136, 2-3/4" "T" strike • Door thickness: 1-5/8" to 1-7/8" • Cylinder: MARKS "C" keyway, 6 pin w/ 2 keys 	
MARKS #		FUNCTION	ANSI #	FINISH GROUPS	
COMM.CYL.	SFIC PREP			3, 32D	10, 10B, 32
N	-	PASSAGE	F75	99.08	126.63
L	-	PRIVACY	F76	118.76	145.01
P	-	PATIO	F77	118.76	146.97
DC	RDC	COMMUNICATING	F80	158.79	185.69
A	RA	ENTRY	F81	140.41	166.66
B	RB	ENTRY	F82A	140.41	166.66
AB	RAB	ENTRY	F109	140.41	166.66
AQ	-	EXIT	F83	131.23	157.47
S	RS	CLASSROOM	F84	140.41	166.66
F	RF	STOREROOM	F86	140.41	166.66
DW	RDW	INSTITUTION	F87	159.44	186.34
DA	RDA	VESTIBULE	F88	159.44	186.34
FQ	-	EXIT	F89	131.23	157.47
DO	-	DUMMY TRIM OUTSIDE	-	103.67	116.79
DT	-	FULL DUMMY TRIM	-	108.92	134.51
NB	-	COMMUNICATING PASSAGE	F111	106.29	119.42
FB	RFB	COMMUNICATING STOREROOM	F112	148.94	164.69
SB	RSB	COMMUNICATING CLASSROOM	F113	148.94	164.69
KNOBS ARE PACKED 12 PER CASE					
NOTE: Split designs and/or finishes are priced at the highest design and/or finish • Special finishes, consult factory					
• SFIC Core Models: Tailpieces included, core not included					
❖ SFIC Core Models in US3 Finish: Add \$42.00 to list price					

OPTIONS	CODE	PRICE
For 2" doors	D1*	NC
For 2-1/4" doors	D2*	48.00
2-3/4" backset, 1-1/8" x 2-1/4" face	E4	8.00
2-3/4" backset, 9/16" throw, Gr. 1, UL Listed	E7	68.00
3-3/4" backset, 9/16" throw, Gr. 1	E10	68.00
Less cylinder	G3	-10.00
4-7/8" ASA strike with curved lip	S1	9.00

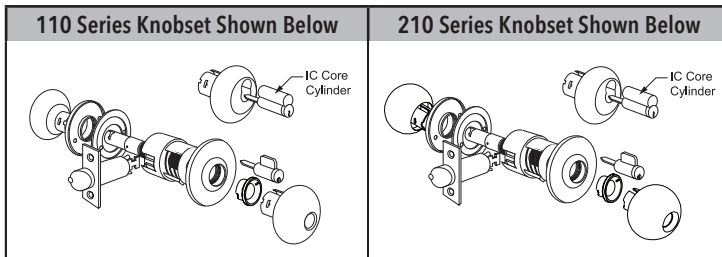

*Prices are for centered on door. For offset, call for price.

★ **Standard & HI-SECURITY™ SFIC Core Models:** 
 Interchangeable Core models for 6 or 7 pin cores (not included).
Accepts: Marks, Marks HI-SECURITY™, Medeco®, KeyMark™, Falcon, Schlage® small format & Best®. **SFIC Core Tailpieces ARE Included.**

95 LINE GRADE 1 CYLINDRICAL SURVIVOR LEVERSETS

BHMA CERTIFIED		ANSI-A156.2 • Grade 1 3 Hour Fire Rating		SURVIVOR SERIES Series 195/195R, 295/295R, 495/495R • 2-3/4" Backset
--------------------------	--	---	--	--

95 Series Leversets Shown Below	Standard Features
	<ul style="list-style-type: none"> Backset 2-3/4" Latch #1834, Front: 1-1/8" x 2-1/4"; Throw: 9/16"; Stainless steel nose Lever: Solid cast Zamac; w/ 1/2" return (except 395 & 495) Roses: Thru-bolted, 3-7/16" dia., spring loaded 2-#10 thru-bolts Strike: #1135, 4-7/8" ASA curved lip strike Door thickness: 1-5/8" to 1-7/8"; For 1-3/8" door use K1904 spacer Cylinder: MARKS "C" keyway, 6 pin w/ 2 keys

MARKS #		FUNCTION	ANSI #	FINISH GROUPS	
COMM. CYL.	SFIC			3, 26D	4, 10, 10B, 19, 26
N	-	PASSAGE	F75	280.83	335.29
L	-	PRIVACY	F76	296.57	354.31
LK	-	HOSPITAL/PRIVACY	F76 MOD.	316.26	372.68
P	-	PATIO	F77	293.29	350.38
DC	RDC	COMMUNICATING	F80	341.12	395.65
A	RA	ENTRY	F81	309.04	365.47
B	RB	ENTRY	F82A	309.04	365.47
AB	RAB	ENTRY	F109	309.04	365.47
AQ	-	EXIT	F83	299.85	357.60
S	RS	CLASSROOM	F84	309.04	365.47
F	RF	STOREROOM	F86	309.04	365.47
DW	RDW	INSTITUTION	F87	340.53	389.81
DA	RDA	VESTIBULE	F88	340.53	389.81
FQ	-	EXIT	F89	299.85	357.60
T	RT	CORRIDOR	F90	316.26	372.68
TO	-	TIME OUT		293.29	350.38
TK	-	HOSPITAL/PRIVACY	F90 MOD.	294.46	350.38
GB	RGB	STORE DOOR	F91	419.92	457.98
BS	RBS	SERVICE STATION LOCK	F92	316.26	372.68
H	-	HOTEL	F93	347.75	402.86
DB	RDB	CLASSROOM INTRUDER	F110	375.31	432.39
DO	-	DUMMY TRIM OUTSIDE	-	78.51	102.99
DT	-	FULL DUMMY TRIM	-	249.33	305.76
NB	-	COMMUNICATING PASSAGE	F111	265.08	320.19
FB	RFB	COMMUNICATING STOREROOM	F112	311.67	360.88
SB	RSB	COMMUNICATING CLASSROOM	F113	311.67	360.88
FEL	RFEL	ELECTRICALLY LOCKED*	-	451.42	508.50
FEU	RFEU	ELECTRICALLY UNLOCKED*	-	451.42	508.50

Marks USA Antimicrobial Finish Available - Option Code: AM - Add \$24 **LEVERS ARE PACKED 6 PER CASE**

NOTE: Split designs and/or finishes are priced at the highest design and/or finish • Special finishes, consult factory
 *ELECTRIFIED FUNCTIONS: 100% Duty Cycle 24V AC/DC, supplied with bridge rectifier : EU - 210 ma ; EL - 125 ma • SFIC Models: Tailpieces included, core not included

OPTIONS	CODE	PRICE- 195	295	495
For 2" doors	D1*	NC	NC	NC
For 2-1/4" doors	D2*	48.00	48.00	48.00
Over 2-1/4" - 4" thickness	D9*	409.00	409.00	409.00
2-3/8" backset, 1" x 2-1/4" face	E6	NC	NC	NC
5" backset, 9/16" throw, Gr. 1	E9	30.00	30.00	30.00
3-3/4" backset, 9/16" throw, Gr. 1	E10	30.00	30.00	30.00
Less cylinder	G3	-10.00	-10.00	-10.00
2-3/4" "T" strike	S3	NC	NC	NC
AMERICAN LEVER ONLY Accepts:				
Yale/Accentra conventional cylinder	F7	15.00	-	-
Sargent conventional cylinder	F8	15.00	-	-
Corbin Russwin conventional cylinder	F9	15.00	-	-
Corbin Russwin 6 pin IC core	F12	22.00	-	-
Corbin Russwin 7 pin IC core	F13	22.00	-	-
Yale/Accentra 6 pin IC core	F14	15.00	-	-
Yale/Accentra 7 pin IC core	F15	15.00	-	-
Schlage 6 pin IC core	F19	15.00	-	-
Sargent IC core	F20	15.00	-	-
Medeco IC core large format	F21	15.00	15.00	-

195 Series Leverset Shown Below	295 Series Leverset Shown Below

495 Series Leverset Shown Below

★ **Standard & HI-SECURITY™ SFIC Models:** Interchangeable Core models for 6 or 7 pin cores (not included). **Accepts:** Marks, Marks HI-SECURITY™, Medeco®, KeyMark™, Falcon, Schlage® small format & Best®. **SFIC Tailpieces ARE Included.**



*Prices are for centered on door. For offset, call for price.

75 LINE GRADE 2 CYLINDRICAL SURVIVOR LEVERSETS

BHMA CERTIFIED			ANSI-A156.2 • Grade 2 Plus 3 Hour Fire Rating		SURVIVOR SERIES Series 175/175R, 275/275R, 475/475R • 2-3/4" Backset		
75 Series Leverset Shown Below				Standard Features			
				<ul style="list-style-type: none"> • Backset: 2-3/4" • Latch #1134, Front: 1-1/8" x 2-1/4"; Throw: 1/2"; Stainless steel nose • Levers: Solid cast Zamac; w/ 1/2" return (except 475) • Roses: Thru-bolted, 3-1/4" dia., spring loaded 2-#10 thru-bolts • Strike: #1145, ASA strike • Door thickness: 1-5/8" to 1-7/8"; For 1-3/8" door use K1904 spacer • Cylinder: MARKS "C" keyway, 6 pin w/ 2 keys 			
MARKS #		FUNCTION	ANSI #	175	275, 475	175, 275, 475	
COMM. CYL.	SFIC PREP			26D	26D	3, 4, 10, 10B, 26	
N	-	PASSAGE	F75	122.64	133.06	145.95	
L	-	PRIVACY	F76	147.78	158.82	171.11	
P	-	PATIO	F77	131.84	142.88	155.14	
DC	RDC	COMMUNICATING	F80	174.77	185.80	198.07	
A	RA	ENTRY	F81	147.78	158.82	171.09	
B	RB	ENTRY	F82A	147.78	158.82	171.09	
AB	RAB	ENTRY	F109	147.78	158.82	171.09	
AQ	-	EXIT	F83	141.65	152.08	171.09	
S	RS	CLASSROOM	F84	147.78	158.82	171.09	
F	RF	STOREROOM	F86	147.78	158.82	171.09	
DW	RDW	INSTITUTION	F87	177.22	189.48	202.36	
DA	RDA	VESTIBULE	F88	178.44	189.48	202.36	
FQ	-	EXIT	F89	141.65	152.08	171.09	
DO	-	DUMMY TRIM OUTSIDE	-	76.22	86.97	99.96	
DT	-	FULL DUMMY TRIM	-	102.41	112.83	125.71	
NB	-	COMMUNICATING PASSAGE	F111	106.18	116.51	125.71	
FB	RFB	COMMUNICATING STOREROOM	F112	155.14	160.66	167.40	
SB	RSB	COMMUNICATING CLASSROOM	F113	155.14	160.66	167.40	

OPTIONS	CODE	PRICE - 175	275	475
2-3/8" backset, 1" x 2-1/4" face	E6	NC	NC	NC
5" backset, 9/16" throw, Gr. 1	E9	68.00	68.00	68.00
3-3/4" backset, 9/16" throw, Gr. 1	E10	120.00	120.00	120.00
Less cylinder	G3	-10.00	-10.00	-10.00
2-3/4" T strike	S3	NC	NC	NC
AMERICAN LEVER ONLY Accepts:				
Yale/Accentra conventional cylinder	F7	15.00	-	-
Sargent conventional cylinder	F8	15.00	-	-
Corbin Russwin conventional cylinder	F9	15.00	-	-
Corbin Russwin 6 pin IC core	F12	22.00	-	-
Corbin Russwin 7 pin IC core	F13	22.00	-	-
Yale/Accentra 6 pin IC core	F14	15.00	-	-
Yale/Accentra 7 pin IC core	F15	15.00	-	-
Schlage 6 pin IC core	F19	15.00	-	-
Sargent IC core	F20	15.00	-	-
Medeco IC core large format	F21	15.00	15.00	-

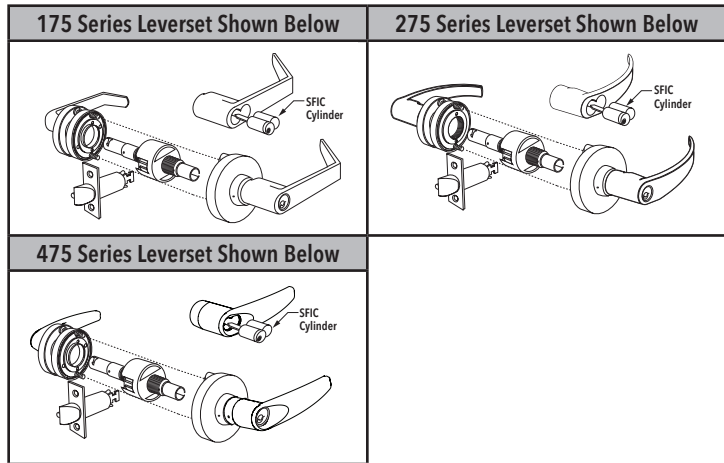

★ **Standard & HI-SECURITY™ SFIC Models:** Interchangeable Core models for 6 or 7 pin cores (not included). **Accepts:** Marks, Marks HI-SECURITY™, Medeco®, KeyMark™, Falcon, Schlage® 'small format & Best'. **SFIC Tailpieces ARE Included.**



CYLINDRICAL LOCK ACCESSORIES

Latches, Strikes, Etc.

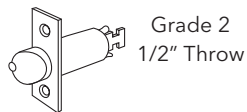

LATCH	THROW	Backset: 2-3/8" Front: 1" x 2-1/4"	Backset: 2-3/4" Front: 1-1/8" x 2-1/4"	FUNCTION	FINISH GROUPS		
					26D	3, 32D	10, 10B
GRADE 2	1/2"	1138A	1134A	ENTRANCE	-	34.63	42.33
		1138L	1134L	PRIVACY	-	25.40	34.63
		1138N	1134N	PASSAGE	-	25.40	34.63
		1138P	1134P	PATIO	-	34.63	42.33
GRADE 1	9/16"	-	1834A	ENTRANCE	-	70.80	76.96
		-	1834L	PRIVACY	-	59.25	70.80
		-	1834N	PASSAGE	-	59.25	70.80
		-	1834P	PATIO	-	70.80	76.96

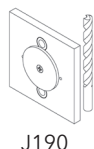
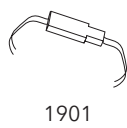
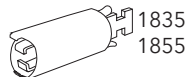
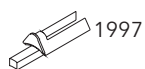
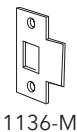

PART	#	DESCRIPTION	FINISH GROUPS	
			3, 32D	10, 10B
STRIKES	1135	4-7/8" ASA strike, curved lip	17.70	17.70
	P1136	2-3/4" "T" strike w/dust box, curved lip	10.77	16.93
	1136-M	2-3/4" "T" strike w/dust box, straight lip	11.54	17.70
SURVIVOR SERIES ALUMINUM SPACER RINGS	K1904	For 1-3/8" door (2 per set), 3-7/16" dia.	30.78	38.48
KNOB SPACER RINGS	K2804	For 1-3/8" door (2 per set), 2-3/4" dia.	30.78	39.25
PART	#	DESCRIPTION	NO FINISH	
EXTENSION LINK For use with 2-3/4" Grade 1 backset latch	1835	3-3/4"	25.40	
	1855	5"		
	1855-P	5" (Grade 1; L, P functions only)		
BRIDGE RECTIFIER	1901	Bridge rectifier 24 V AC/DC (no finish)	38.48	
CYLINDER RETAINER	1997	Lever handle cylinder retainer	4.63	
INSTALLATION TOOL	J295	175/195 installation drill jig	147.75	

CYLINDRICAL LOCK ACCESSORIES

Cylinders

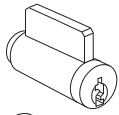

Conventional Cylinder

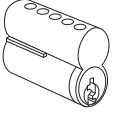

SFIC Cylinder
(Will Fit Best® Housings)

FOR KEYS & KEYING, SEE PAGE 67

PART #	DESCRIPTION	PRICE
1982	6 Pin, w/2 nickel-silver keys	26.85
*RC1182	6 Pin core, construction core	35.60
RC1187	Plastic core turnknob	6.42

IC core pricing includes KA, KD or MK Keying.

*Consult Factory on pricing of IC Cores when ordered with Locksets.

Specify Tailpiece; Tailpiece Not Included.

Cylindrical Lock Tailpieces



1903



1903S



1903-L



1903S-L



F1903-C

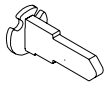

F1903S-C

PART #	CODE	FUNCTION	CYLINDER	PRICE
1903	9	AB, B, DA (ext.), DW, F, FEL, FEU	MARKS 1982	5.84
1903S	S9	S, DA (int.), DB, DC, SB, T		
1903-L	L9	AB, B, DA (ext.), DW, F, FEL, FEU	Arrow PK 100C, Ilco 705, Lori 1539, Sargent 13-3266, Abloy, ASSA 65673, 65691	5.84
1903S-L	SL9	S, DA (int.), DB, DC, SB, T		
F1903-C	-	AB, B, DA (ext.), DW, F, FEL, FEU	Schlage 23-001, Primus, Corbin-Russwin 2000-034	5.84
F1903S-C	-	S, DA (int.), DB, DC, SB, T		

Cylindrical IC Core Tailpieces

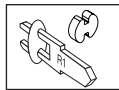

HR1984

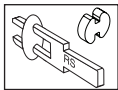

HR1984S

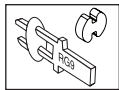

HR1984-G

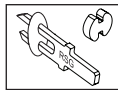

HR1984S-G



AR1989-Y



AR1989S-Y



AR1999-M



AR1999S-M



F1903C-F19

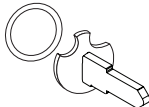

F1903S-F19



R1981



R1983

For Keying information see Pages 68

PART #	CODE	FUNCTION	CORE	PRICE
HR1984	R1	AB, B, DA (ext.), DW, F, FEU, FEL	6 or 7 pin Marks, KSP, Best®, Falcon, Medeco®, Keymark®, Sargent®, Schlage® Small Format	5.84
HR1984S	RS	S, DA (int.), DB, DC, SB, T		
HR1984-G	RG9	AB, B, DA (ext.), DW, F, FEU, FEL	6 or 7 pin Corbin Russwin	5.84
HR1984S-G	RSG	S, DA (int.), DB, DC, SB, T		
AR1989-Y	9MY	AB, B, DA (ext.), DW, F, FEU, FEL	6 or 7 pin Yale/Accentra	7.00
AR1989S-Y	9SY	S, DA (int.), DB, DC, SB, T		
AR1999-M	9M	AB, B, DA (ext.), DW, F, FEU, FEL	Medeco® LFIC	7.00
AR1999S-M	9SM	S, DA (int.), DB, DC, SB, T	Medeco® LFIC	7.00
F1903C-F19	-	AB, DW, F	6 pin Schlage® Large Format	7.00
F1903S-F19	-	S, DA, DB, DC, SB, T		
R1981		Spacer		5.84
R1983		Security Disc		5.84

TAILPIECES FOR 195BH

P/N	FITS	OPTION CODE	PRICE
MH119	YALE/ACCENTRA / MEDECO IC CORE	F14, F15, F21	7.00
MH140	CONVENTIONAL (K.I.L.) CYL	N/A	7.00
MH144	SFIC	R, F20	7.00
MH146	CORBIN RUSSWIN LFIC	F12, F13	7.00
MH1903S-C	SCHLAGE IC / CORBIN RUSSWIN K.I.L.	F19, F9	7.00















CYLINDRICAL KNOB/LEVER FUNCTIONS













ANSI# CODE	MARKS FUNCTION
F75	N
F76	L
F76 (MOD.)	LK
F77	P
F80	DC
F81	A

ANSI# CODE	MARKS FUNCTION
F82A	B
F83	AQ
F84	S
F86	F
F87	DW
F88	DA

ANSI# CODE	MARKS FUNCTION
F89	FQ
F90	T
F90 (MOD.)	TK
F91 (95 Series Leverset ONLY)	GB
F92	BS
F93	H

ANSI# CODE	MARKS FUNCTION
F109	AB
F110	DB
F111	NB
F112	FB
FB	FB
F113	SB

ANSI # CODE	Marks Function	
	I/S	O/S
F75 PASSAGE: Latch by knob/lever either side.		N
F76 PRIVACY: Latch by knob/lever either side unless outside knob/lever locked by push-button from inside. Outside unlocks by turning inside knob/lever, outside emergency turn or closing door.		L
F76 (MOD.) HOSPITAL/PRIVACY: Latch by knob/lever either side unless outside knob/lever locked by push-button from inside. Outside unlocks by turning inside knob/lever, outside turn or closing door. Emergency turn-knob A5 option.		LK
F77 PATIO: Deadlocking latch by knob/lever either side unless outside knob/lever locked by push-button inside. Unlocks by turning inside knob/lever or closing door.		P
F80 COMMUNICATING: Key both sides. Locks or unlocks either knob/lever independent of the other. Deadlocking latch.		DC
F81 ENTRY: Deadlocking latch bolt by knob/lever either side except when outside locked by turn-button inside. When outside locked, key outside or knob/lever inside opens lock. Turn-button operated manually.		A
F82A ENTRY: Deadlocking latch by knob/lever either side. Outside locked by push-button inside. When outside locked by push-button inside, key opens lock, unlocks push-button. Inside knob/lever always opens latch. Closing door does not release push-button.		B
F83 EXIT: Deadlocking latch by knob/lever either side except when outside locked by turn-button inside. Inside knob/lever always opens latch. Turn-button operated manually.		AQ
F84 CLASSROOM: Deadlocking latch by knob/lever inside. Outside knob/lever locked or unlocked by key.		S
F86 STOREROOM: Deadlocking latch by knob/lever inside, key outside. Outside knob/lever always locked.		F
F87 INSTITUTION: Both knob/levers always locked. Deadlocking latch by key both sides.		DW
F88 VESTIBULE: Deadlocking latch by knob/lever either side, except when outside knob/lever locked by key inside. Key outside retracts deadlocking latch. Inside always open.		DA
F89 EXIT: Deadlocking latch by knob/lever inside. Outside always locked.		FQ
F90 CORRIDOR: Deadlocking latch by knob/lever either side unless outside locked by key or inside push-button. Unlock by key, turning inside knob/lever or closing door.		T
TIME OUT LOCK Deadlocking latch by knob/lever either side unless inside knob/lever locked by holding push-button outside. Releasing push-button unlocks inside.		TO

ANSI # CODE	Marks Function	
	I/S	O/S
F90 (MOD.) HOSPITAL/PRIVACY: Deadlocking latch by knob/lever either side unless outside locked by knob/lever or inside push-button. Unlock by turn-knob, turning inside knob/lever or closing door. Emergency turn-knob A5 option.		TK
F91 STORE DOOR (95 Series Leverset ONLY): Deadlocking latch by knob/lever either side except when both knob/levers are locked by key from either side.		GB
F92 SERVICE STATION LOCK: Deadlocking latch by knob/lever either side unless outside locked by key or inside push-button. Unlock by key, turning inside knob/lever or closing door, except when slotted push-button is turned in locked position. Inside knob/lever always opens latch.		BS
F93 HOTEL: Deadlocking latch by knob/lever inside. Outside knob/lever always locked. Inside push-button projects indicator on cylinder face shutting out all keys except emergency key. Turning inside knob/lever or closing door releases push-button.		H
F109 ENTRY: Outside locked by pushing turn-button inside. Key outside opens lock. Rotating inside knob/lever releases button and outside knob/lever. By pushing and turning inside button, outside knob/lever remains locked. Deadlocking latch.		AB
F110 CLASSROOM INTRUDER: Deadlocking latch by knob/lever either side, except when outside locked by key inside. Key outside locks or unlocks outside. Inside always open		DB
DUMMY TRIM: Outside only, rigid.		DO
DUMMY TRIM: Both sides, rigid.		DT
F111 COMMUNICATING PASSAGE: Blank outside. Deadlocking latch by knob/lever inside.		NB
F112 COMMUNICATING STOREROOM: Blank outside. Deadlocking latch by key only. Knob/lever always locked.		FB
F113 COMMUNICATING CLASSROOM: Blank outside. Inside knob/lever locked or unlocked by key. Deadlocking latch.		SB
ELECTRICALLY LOCKED - FEL (Fail Safe): Outside always locked electrically. Open by key outside, switch or loss of power. Deadlocking latch by lever inside. Lever only.		FEL
ELECTRICALLY UNLOCKED - FEU (Fail Secure): Outside always locked until unlocked by key or electrically energized. Deadlocking latch by lever inside. Lever only.		FEU

HOW TO ORDER TUBULAR LOCKSETS

How To Order Example for Tubular Locksets

1	RW	92	N	/	32D	-	S3
<i>1. Lockset Series</i>	<i>2. Rose Design</i>	<i>3. Knob/Lever</i>	<i>4. Marks Function</i>	<i>Slash</i>	<i>5. Finish</i>	<i>Dash</i>	<i>6. Options</i>

1	SERIES
Tubular Locksets	1
Cylindrical Cartridge	1

2	ROSES
ROSES	DESIGN
9602-R	Rose with ring 2-9/16" dia. RR
9602	Plain rose 2-9/16" dia. RW
5602-R	Small rose with ring 2-1/4" dia. RQ
5602	Small rose 2-1/4" dia. RS
7602	Square rose 2-9/16" square RX
7607	Square forged rose 2-9/16" square RK

3	KNOB/LEVER
KNOB	DESIGN
1153	Round, wrought 10
1253	Ball, wrought 20
9631	Ball, forged 30
9609	Eclipse, forged 60
LEVER	DESIGN
SF031	Copa 031
5657	Monaco 57
5672	Towne 72
5677	Maxwell 77
5678	Omni 78
5682	Plaza 82
5683	Dayton 83
5686	Crescent 86
5692	American 92
5696	Titan 96



4	TUBULAR FUNCTIONS
MARKS #	ANSI #
TUBULAR LOCKSETS	
N	PASSAGE F75
L	PRIVACY F76
NB	COMMUNICATING F111
DI	DUMMY TRIM INSIDE
DO	DUMMY TRIM OUTSIDE
DT	FULL DUMMY



5	FINISH
MARKS	ANSI #
US 3	Polished Brass, Clear Coated 605
US 4	Satin Brass, Clear Coated 606
US10	Satin Bronze, Clear Coated 612
US 10B	Dark Bronze, Clear Coated 613
US15	Satin Nickel 619
US 26	Polished Chrome, Plated 625
US 26D	Satin Chrome, Plated 626
US 32	Polished Stainless Steel 629
US 32D	Satin Stainless Steel 630

6	OPTIONS
TRIM MODIFICATIONS	CODE PRICE
Tactile knob/lever, coated ext. only	A1 38
Tactile knob/lever, knurled	A4 38
Tactile knob/lever, coated int. & ext.	A18 78
DOOR THICKNESS	CODE PRICE
1-3/4"	D4 NC
1-3/8"	D5 NC
LATCH	CODE PRICE
2-3/4" backset, 1-1/8" x 2-1/4" face	E4 8
2-3/4" backset, 9/16" throw, Gr. 1, UL Listed With Cylindrical Cartridge★	E7 68
2-3/8" backset, 1-1/8" x 2-1/4" face	E11 9
2-3/4" backset, 1 x 2-1/4" face	E12 9
Adjustable latch 1-1/8" x 2-1/4" face	E13 8
TRIM CHANGES	CODE PRICE
For 1-1/2" bore	F6 13
STRIKE	CODE PRICE
4-7/8" ASA strike	S1 9
2-3/4" "T" strike	S3 NC
3-5/8" Security strike	S4 8
2-1/4" Curved lip strike	S5 NC

★ E7 Option Available: 2-3/8", 2-3/4", 3-3/4" & 5" Backset, for N Function ONLY.

TUBULAR KNOB/LEVER FUNCTIONS

ANSI # CODE	Marks Function	
	I/S	O/S
F75 PASSAGE: Latch by knob/lever either side.		N
F76 PRIVACY: Latch by knob/lever either side unless outside knob/lever locked by push-button from inside. Outside unlocks by turning inside knob/lever, outside emergency turn or closing door.		L
F111 COMMUNICATING: Blank outside. Deadlocking latch by knob/lever inside.		NB

ANSI # CODE	Marks Function	
	I/S	O/S
DUMMY TRIM INSIDE: Dummy trim inside ONLY.		DI
DUMMY TRIM OUTSIDE: Dummy trim outside ONLY.		DO
FULL DUMMY TRIM: Dummy trim both sides.		DT

ROSE DESIGN RR, RW, RQ, RS, RX*, RK*, RL*

Tubular Locksets

	ANSI-A156 • Grade 2		Series 1 • 2-3/8" Backset			
	Standard Features		KNOBS	LEVERS		
	<ul style="list-style-type: none"> • Backset: 2-3/8", 2-3/4" optional • Front: 1" x 2-1/4" • Thru-bolted screwless knob/lever rose • Concealed mounting screws • Lever support springs • Independent spring loaded captivated spindles • Strike: 2-1/4" full curved lip • Latch support housing • Door thickness: 1-3/8" to 1-3/4" • Privacy function - interior with automatic release 		10, 20	F002, 031, 037A, 44, 55, 57, 72, 77, 78, 82, 83, 86, 92, 96		F002, 037A 82, 83, 86, 92, 96, 031 037A,
MARKS #	FUNCTION	ANSI #	FINISH GROUPS			
			3, 32D	3, 4, 15, 26D	10, 10B, 19 14, 26	32, 32D

KEYLESS						
N	PASSAGE	F75	158.79	213.24	238.83	205.37
L	PRIVACY	F76	166.00	220.46	246.05	212.59
NB	COMMUNICATING	F111	194.87	206.03	230.96	198.81

DUMMY TRIM						
DI	DUMMY TRIM INSIDE					
DO	DUMMY TRIM OUTSIDE		74.14	102.36	114.17	97.11
DT	FULLY DUMMY		148.29	202.75	227.68	194.87

KNOBS & LEVERS ARE PACKED 16 PER CASE
 NOTE: Split designs and/or finishes are priced at the highest design and/or finish • Special finishes, consult factory
 *Square Rose RX: Add \$21 / *Square Rose RZ: Add \$47 / *Square Rose RK: Add \$65

KNOBS	Round Knob 10	Ball Knob 20	Commerce Lever 037A	Metropolitan Lever 002	ROSES	RR: 2-9/16" dia.	
							RW: 2-9/16" dia.
	Lucida Lever 47C	Copa Lever 031	Brompton Lever 55	Monaco Lever 57 Specify handing			RQ: 2-1/4" dia.
	Towne Lever 72	Maxwell Lever 77	Omni Lever 78	Plaza Lever 82			RS: 2-1/4" dia.
Dayton Lever 83 Specify handing	Crescent Lever 86	American Lever 92	Titan Lever 96			RK: 2-1/2" sq. RK: 2-1/2" sq. RL: 1-1/2" sq.	

OPTIONS	CODE	PRICE	NOTE
1-3/8" door thickness	D5	0.00	
2-3/4" backset, 1-1/8" x 2-1/4" face	E4	8.00	
2-3/4" backset, 9/16" throw, Gr. 1, UL Listed WITH CYLINDRICAL CARTRIDGE *	E7	30.00	N Function Only
2-3/8" backset, 1-1/8" x 2-1/4" face	E11	9.00	
2-3/4" backset, 1" x 2-1/4" face	E12	9.00	
4-7/8" ASA strike	S1	9.00	
2-3/4" "T" strike	S3	0.00	

* E7 Option Available: 2-3/8", 2-3/4", 3-3/4" & 5" Backset, for N Function ONLY.

INTERIOR TUBULAR LOCKSETS

Tubular Locksets



NEW! 60 Series, Stainless Steel, Commercial Locksets

Standard Features

- Latch Face: 1" x 2-1/4" standard
- Backset: 2-3/4" with 2-3/4" T-strike with square corners
- Door thickness: 1-3/8" to 1-3/4"
- Roses: 2-9/16" diameter
- Backset: 2-3/8" with 2-1/4", radius corner full lip strike, option E6, N/C
- Privacy Function with kick-off latch

MARKS #	FUNCTION	ANSI #	FINISH GROUPS (160, 260 & 360)	
			32, 32D	
N	PASSAGE	F75	128.41	
L	PRIVACY	F76	137.16	
DO	DUMMY TRIM OUTSIDE	-	64.20	

LEVERS ARE PACKED 9 PER CASE Additional finishes, consult factory

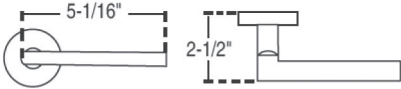
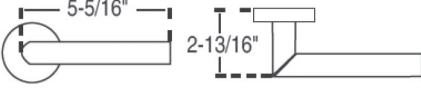
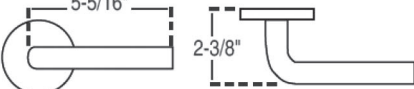
160 Series Finishes: 32D	260 Series Finishes: 32D	360 Series Finishes: 32D
		
		

TUBULAR LOCKSET ACCESSORIES

Strikes, Latches, Support Housing

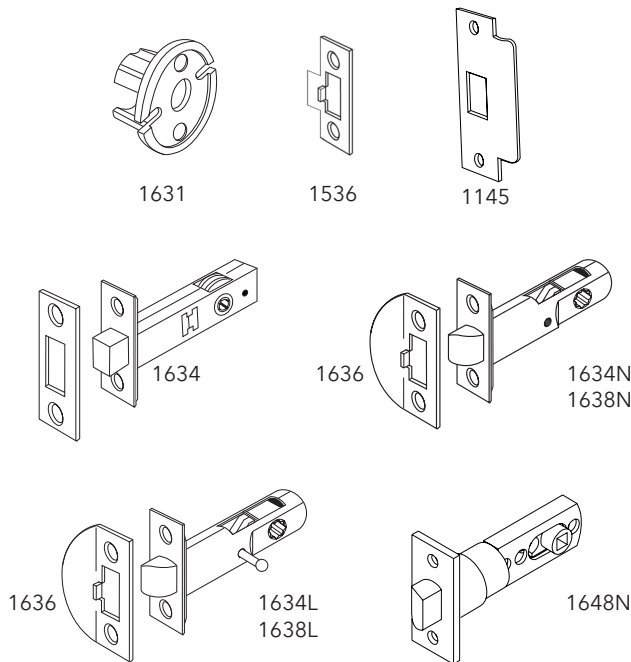

PART #	DESCRIPTION	BACKSET FRONT	FINISH GROUPS		
			NO FINISH	3, 26	10, 10B, 32, 32D
1631	Support housing	-	7.69	-	-
1536	"T" Strike, 2-3/4" curved lip	-	-	7.70	12.31
1145	4-7/8" ASA strike	-	-	9.23	16.93
1634	Tubular deadbolt	2-3/4"	-	82.34	87.73
1636	Strike, 2-1/4" full curved lip	-	-	7.70	12.31
1634N	Passage latch w/ strike	2-3/4"	-	58.48	74.65
1634L	Privacy latch w/ strike	1" x 2-1/4"	-	70.03	77.72
1638N	Passage latch w/ strike	2-3/8"	-	37.71	47.71
1638L	Privacy latch w/ strike	1" x 2-1/4"	-	47.71	56.95

Latches & Cylindrical Cartridge

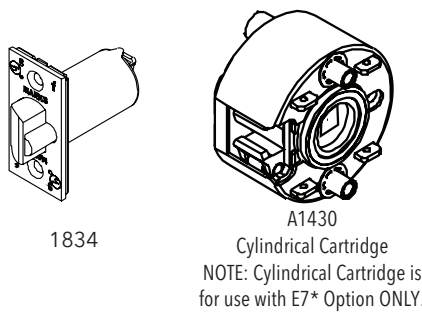

LATCH	THROW	Backset 2-3/8"; Front 1" x 2-1/4"	Backset 2-3/4"; Front 1-1/8" x 2-1/4"	FUNCTION	FINISH GROUPS	
					3, 32D	10, 10B
GRADE 2	1/2"	1138A	1134A	ENTRANCE	34.63	42.33
GRADE 1	9/16"	-	1834A	ENTRANCE	70.80	76.96

PART #	DESCRIPTION	NO FINISH
A1430	Cylindrical Cartridge	50.02

HOW TO ORDER DEFENDER LOCKSETS



Defender Series



How To Order Example for Defender Locksets					
145	K	/	32D	-	D1
1. <i>Lockset Series</i>	2. <i>Marks Function</i>	<i>Slash</i>	3. <i>Finish</i>	<i>Dash</i>	4. <i>Options</i> <i>Specify: Keying, Handing & Door Thickness</i>

1 SERIES				
Defender Tubular Deadbolt Locksets		130, 130R		
Defender Cylindrical Cartridge Deadlatch Locksets		145, 145R		
2 TUBULAR FUNCTIONS				
DEADBOLT/DEADLATCHES (* indicates IC Core)	130 Series	145 Series		
K RK* CYLINDER x TURNPIECE	E0151	E01101		
KK RKK* CYLINDER x KNOB				
L RL* COMM. SINGLE CYLINDER	E0161	E0131		
KL RKL* CYLINDER x LEVER		E01101		
M RM* DOUBLE CYLINDER	E0141	E01111		
S RS* CLASSROOM	E0171			
X X TURNPIECE	E0191	E01121		
3 FINISH				
MARKS				ANSI #
US 3 Polished Brass, Clear Coated				605
US10 Satin Bronze, Clear Coated				612E
US 10B Dark Bronze, Clear Coated				613E
US 19 Black				622
US 26D Satin Chrome, Plated				626
US 32 Polished Stainless Steel				629
US 32D Satin Stainless Steel				630

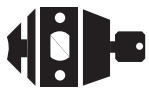
DEADBOLT/DEADLATCH FUNCTIONS

ANSI # CODE	MARKS # FUNCTION	ANSI # CODE	MARKS # FUNCTION
130 SERIES:			
E0151	K	E01101	K
E0161	L	E0131	L
E0141	M	E01101	KL
E0171	S	E01111	M
E0191	X	E01121	X

ANSI # CODE	Marks Function	
	I/S	O/S
CYLINDER x TURNPIECE: Deadbolt/deadlatch by inside turnpiece or outside key.		K
COMMUNICATING SINGLE CYLINDER: Deadbolt/deadlatch by key from one side only.		L
CYLINDER x LEVER: Deadlatch by key outside. Inside lever always opens latch.		KL

ANSI # CODE	Marks Function	
	I/S	O/S
DOUBLE CYLINDER: Deadbolt/deadlatch by key either side.		M
CLASSROOM: Deadbolt by outside key. Turnpiece will retract but not project deadbolt.		S
TURNPIECE x BLANK PLATE: Deadbolt/deadlatch by inside turnpiece. Blank plate outside.		X

130 SERIES "DEFENDER" TUBULAR DEADBOLTS

Defender Series

ANSI 156.5				Standard Features	
 <p style="text-align: center;">130K</p>				<ul style="list-style-type: none"> • Bolt: 1" throw • Unitized assemblies for 2-1/8" bore • Strike: #1335, 2-3/4" x 1-1/8" strike • Door thickness: 1-3/8" to 1-7/8" • Cylinder: MARKS "C" keyway, 6 pin w/ 2 keys • 2-3/8" Backset • Latch front: 1" x 2-1/4" 	
MARKS #		FUNCTION	ANSI #	FINISH GROUPS	
COMM. CYL.	IC CORE CYL.*			3, 32D	10, 10B, 19, 32
K	RK	CYLINDER x TURNPIECE	E0151	137.79	254.52
L	RL	COMMUNICATING SINGLE CYL	E0161	137.79	254.52
M	RM	DOUBLE CYLINDER	E0141	133.19	249.93
S	RS	CLASSROOM	E0171	120.07	236.81
X	-	TURNPIECE x BLANK PLATE	E0191	96.45	213.18

DEADBOLTS ARE PACKED 24 PER CASE

NOTE: Split designs and/or finishes are priced at the highest design and/or finish • Special finishes, consult factory
• IC Core Models: Core not included

OPTIONS	CODE	PRICE
For 2" door	D1	NC
For 2-1/4" door	D2	48.00
For 1-1/4" - 1-1/2" door	D8	NC
2-3/4" backset, 1-1/8" x 2-1/4" face	E4	8.00
Sargent original cylinder or core	F8	15.00
Less cylinder	G3	-10.00
3-5/8" x 1-1/4" Security strike	S4	8.00

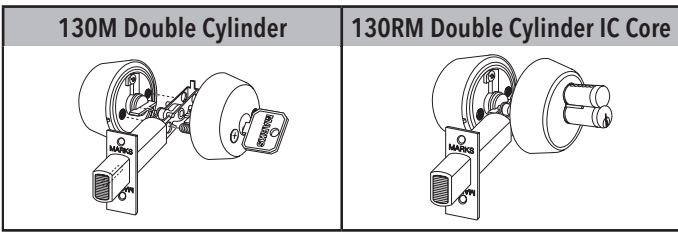

★ Standard IC Core Models: 

Interchangeable Core models for 6 or 7 pin cores (not included).

Accepts: Marks, Medeco KeyMark™, Falcon & Best®. IC Core Tailpieces ARE Included.

145 SERIES "DEFENDER" CYLINDRICAL CARTRIDGE DEADLATCHES

ANSI 156.5 • 3 Hour Fire Rating		c UL US LISTED		Standard Features	
 <p style="text-align: center;">145M</p>				<ul style="list-style-type: none"> • Series 1 Cylindrical Cartridge • Latch: Grade 1, 9/16" throw, 2-3/4" backset • Unitized assemblies for 2-1/8" bore • Strike: #1136, 2-3/4" strike • Door thickness: 1-3/4"; For 1-3/8" doors use spacer rings K1442/32D • Cylinder: MARKS "C" keyway, 6 pin w/ 2 keys • Latch front: 1-1/8" x 2-1/4" 	
MARKS #		FUNCTION	ANSI #	FINISH GROUPS	
COMM. CYL.	IC CORE CYL.*			3, 32D	10, 10B, 19, 32
K	RK	CYLINDER x TURNPIECE	E01101	148.94	265.67
L	RL	COMMUNICATING SINGLE CYL	E0131	148.94	265.67
M	RM	DOUBLE CYLINDER	E01111	161.41	278.14
X	-	TURNPIECE x BLANK PLATE	E01121	126.63	243.37
KL	RKL	CYLINDER x LEVER	E01101	251.96	368.69
KK	RKK	CYLINDER x KNOB		261.80	378.53

DEADLATCHES ARE PACKED 24 PER CASE

NOTE: Split designs and/or finishes are priced at the highest design and/or finish • Special finishes, consult factory
• IC Core Models: Core not included

OPTIONS	CODE	PRICE
For 2" door	D1	NC
For 2-1/4" door	D2	48.00
2-3/8" backset, 1-1/8" x 2-1/4" face	E11	9.00
Sargent original cylinder or core	F8	15.00
Less cylinder	G3	-10.00
4-7/8" ASA strike	S1	9.00

★ Standard IC Core Models: 

Interchangeable Core models for 6 or 7 pin cores (not included).

Accepts: Marks, Medeco KeyMark™, Falcon & Best®. IC Core Tailpieces ARE Included.

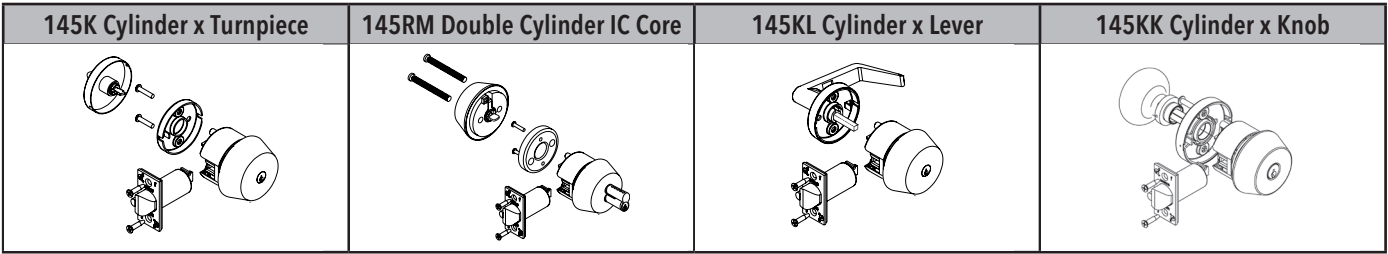

DEFENDER SERIES ACCESSORIES

Strikes, Latches & Spacers

Defender Series

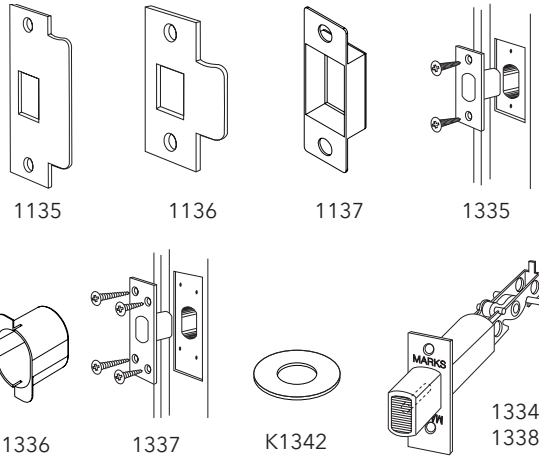

PART #	DESCRIPTION	FINISH GROUPS		
		NO FINISH	3, 32D	10, 10B, 32
1135	4-7/8" ASA STRIKE	-	17.70	17.70
1136	2-3/4" "T" STRIKE W/DUST BOX	-	7.69	11.55
1137	DUST BOX, PLASTIC, LATCH	4.62	-	-
1335	2-3/4" x 1-1/8" STANDARD STRIKE	-	6.16	7.69
1336	DUST BOX, PLASTIC, DEADBOLT	4.62	-	-
1337	3-5/8" x 1-1/4" HIGH SECURITY STEEL STRIKE, PLATED FINISH	-	52.33	-
K1342	1-3/8" DOOR, ROSE EXTENDERS, 130 Series	-	41.56	51.56
DEADBOLTS				
1334	2-3/4" BACKSET FRONT 1-1/8" x 2-1/4"	-	26.94	33.86
1338	2-3/8" BACKSET FRONT 1-1/8" x 2-1/4"	-	26.94	33.86
K1442	1-3/8" DOOR, 145 SERIES	-	119.28	-

Latches & Cylindrical Cartridge

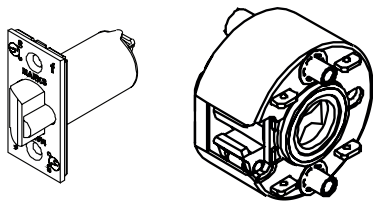

1834

A1420 Cylindrical Cartridge for use with 145 Series
NOTE: Cylindrical Cartridge is for use with E7* Option ONLY.

LATCH	THROW	Backset 2-3/8" Front 1" x 2-1/4"	Backset 2-3/4" Front 1-1/8" x 2-1/4"	FUNCTION	FINISH GROUPS	
					3, 32D	10, 10B
GRADE 2	1/2"	1138A	1134A	ENTRANCE	34.63	42.33
GRADE 1	9/16"	-	1834A	ENTRANCE	70.80	76.96

PART #	DESCRIPTION	NO FINISH
A1420	Cylindrical Cartridge for use with 145 Series	84.65

Tailpieces & Cylinders

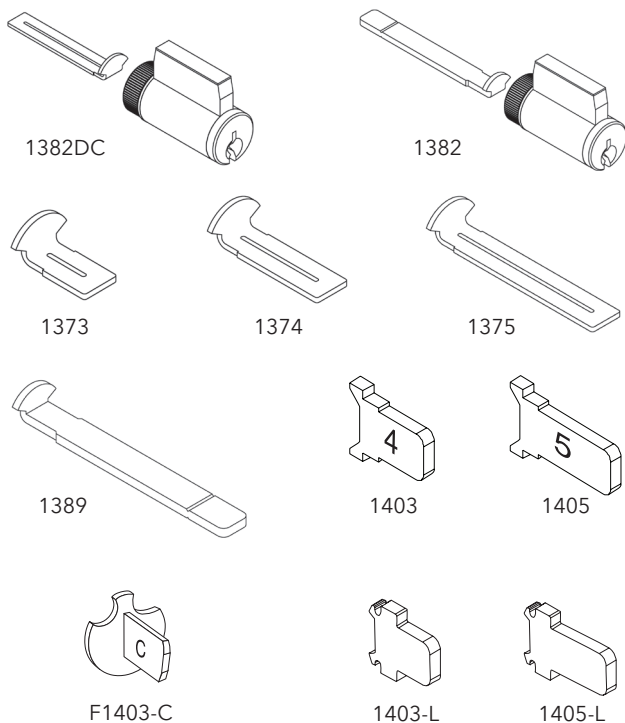







PART #	TAILPIECES FOR 130 DEADBOLTS	PRICE
DOUBLE CYLINDER		
1373	1-5/16" to 1-3/8"	4.09
1374	1-5/8" to 2"	MARKS 1382DC
1375	2-1/8" to 2-3/8"	
SINGLE CYLINDER		
1389	1-3/4" to 2-1/4"	MARKS 1382
1403	1-5/8" to 1-7/8"	MARKS TAILPIECE
EF1903-C	2" to 2-1/4"	
F1403-C	1-5/8" to 1-7/8"	SCHLAGE® TAILPIECE
1403-L	1-5/8" to 1-7/8"	LORI / ILCO TAILPIECES
1405-L	2" to 2-1/4"	

I-QWIK LITE SERIES



NO-NONSENSE ACCESS CONTROL RIGHT OUT OF THE BOX

MARKS #		LOCKSET TYPE - PACKED 4 PER CASE	# OF USERS	FINISH GROUPS	
IQ1LITE	IQ1L/26D			19 Black Powder Coat; with 26D American Levers	26D Satin Chrome
		IQ1: Cylindrical Lockset - PACKED 4 PER CASE	160	690.16	794.66
		IQ2: Mortise Lockset - PACKED 4 PER CASE	160	1114.21	1218.71
		IQ7: Rim Exit Device Interface - PACKED 6 PER CASE Adapter plates operate most manufacturers Rim Exit Devices. Adapter plates for Mounting Exit Devices are sold separately, see page 70.	160	968.40	1074.12

Access Control

Standard Features

- CableGard™ protects wires for easy installation
- Standard ANSI door prep with one additional hole
- Pre-programmed code
- Keypad programmable
- 160 User codes
- Temporary user codes
- Passage mode
- Pin only mode
- Double code entry for maximum security
- Two wire remote release
- 16 Digit tactile metal keypad
- Weatherproof standard
- Audible & visible entry indicator
- Audible low battery alert
- 4 "AA" batteries, 95,000 operations
- Easy installation
- Lifetime Mechanical Warranty; 2 Year Electronic Warranty

IQ1 LITE Cylindrical Lockset Specifications

- Door Thickness:** 1-3/4" standard;
For thicker doors, Consult factory
- Handing:** Non-handed
- Key Override:** Marks "C" keyway, 6 pin w/2 keys, IC Core optional
- Lock Body:** Cylindrical "Survivor" featuring the "Clutch" for trouble free service
- Latch:** Grade 2, 2-3/4" backset, 1/2" throw, 3 Hour UL fire rating
- Strike Plate:** 4-7/8" ASA strike

IQ2 LITE Mortise Lockset Specifications

- Door Thickness:** 1-3/4" standard;
For thicker doors, Consult factory
- Handing:** Field reversible
- Key Override:** 1-1/8" Mortise cylinder, 6 pin w/2 keys
- Lock Body:** Grade 1, Series 5, 2-3/4" backset, 3/4" anti-friction latch, 3 Hr UL fire rating
- Auxiliary Latch:** 1/2" throw
- Clutch:** The "Clutch" for trouble free service
- Strike Plate:** 4-7/8" ASA standard

IQ7 LITE Rim Exit Device Interface Specifications

- Door Thickness:** 1-3/4" standard;
For thicker doors, Consult factory
- Handing:** Non-handed
- Key Override:** 1-1/8" Mortise cylinder, 6 pin w/2 keys
- Clutch:** The "Clutch" for trouble free service
- Adapter plates operate most manufacturers Rim Exit Devices. Adapter plates for Mounting Exit Devices are sold separately, see page 53.**

How To Order Example for i-Qwik LITE Series Electronic Access Control Locksets

IQ	1LITE	
1. Lockset Series	19 Finish	2. Model Number
		26D Finish
___ IQ	___ 1LITE (Cylindrical)	___ 1L/26D (Cylindrical)
	___ 2LITE (Mortise)	___ 2L/26D (Mortise)
	___ 7LITE (Rim Exit Device Interface)	___ 7L/26D (Rim Exit Device Interface)

I-QWIK LITE

OPTIONS



Access Control

I-QWIK OPTIONS			Cylindrical	Mortise	Rim Exit Device Interface
DESCRIPTION	CODE	PRICE	IQLITE	IQLITE	IQLITE
Backset					
2-3/8" Backset	E6	NC	•		
5" Backset	E9	30.00	•		
3-3/4" Backset	E10	30.00	•		
Levers					
Tactile Lever	A1	38.00	•	•	•
Lever to accept Sargent conventional cyl.	F8	15.00	•		
Lever to accept Corbin Russwin conventional cyl.	F9	15.00	•		
Lever to accept Corbin Russwin IC Core 6 pin	F12	22.00	•		
Lever to accept Corbin Russwin IC Core 7 pin	F13	22.00	•		
Lever to accept Yale/Accentra IC Core 6 pin	F14	15.00	•		
Lever to accept Yale/Accentra IC Core 7 pin	F15	15.00	•		
Lever to accept Large Format Schlage	F19	15.00			
Lever to accept Sargent IC Core	F20	15.00	•		
Lever to accept Medeco IC Core lg. format	F21	15.00	•		
Solid Exterior Handle (no cylinder)	W4	NC	•	Std	Std
Crescent Lever	W7	13.00	•	•	•
Titan Lever	W12	13.00	•	•	•
American Lever US19	W20	15.00	•	•	•
Cylinder					
SFIC Cylinder Housing	G1	NC	•	•	•
Less Cylinder	G3	-10.00	•	•	•
Strike					
4-7/8" ASA Strike	S1	15.00	•	Std	
2-3/4" "T" Strike	S3	NC	Std		
Miscellaneous					
Tamper-proof Screws	A3	10.00	•	•	•







IQWIK LITE ACCESSORIES

Access Control

I-QWIK ACCESSORIES			Cylindrical	Mortise	Rim Exit Device Interface
ACCESSORY	PART #	PRICE			
Bridge Rectifier (converts AC power to DC power)	1901	32.32	•	•	•
Gasket (interior inside housing for full weatherproofing)	E1108	6.16	•	•	
Battery Pack Holder	EA4011	16.16	•	•	•
Spacer Kit, 1-3/8" Door (Int. & Ext. Gaskets)	EK1038	47.71	•	•	•
Internal power connector for hardwiring i-Qwik/i-Que Locksets	E1133	23.08	•	•	•
Memory Reset Jumper	E1155	16.16	•	•	•
Spacer Ring for 1-1/4" mortise cylinder	E2006	16.16		•	•
Spacer Ring for 1-3/8" mortise cylinder	E2007	16.16		•	•
Rim Exit Device Adaptor Plate					
Von Duprin 98/99 Rim Adapter Plate / M9900 Marks Detex Advantex 10 Series Rim Adapter Plate	E7071	61.57			•
Precision 1100 Rim Adapter Plate	E7072	61.57			•
Yale/Accentra 7100 Rim Adapter Plate/ Corbin Russwin ED5200 Rim Adapter Plate	E7073	61.57			•
Dorma 9300 Rim Adapter Plate	E7074	61.57			•
Sargent 8800/PE80 Rim Adapter Plate/ Arrow 3800 Rim Adapter Plate	E7075	61.57			•
Precision 21 Rim Adapter Plate/ Precision 2100 Rim Adapter Plate**	E7076	61.57			•
Von Duprin 88 - Special Order, Consult Factory	E7077	61.57			•
Monarch 18R Exit Device Adapter Plate	E7078	70.03			•



NOTE: Consult Factory for Additional Exit Devices; **Must use Precision #BP21 backplate.

TAILPIECES & CAMS

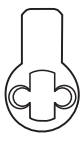
CYLINDRICAL TAILPIECES Cylindrical Conventional				
	FOR USE WITH	LEVER	CODE	PRICE
	Marks 1982	E1903	E1	5.84
	Arrow PK 100C, ILCO 705, Sargent 13-3266, Lori 1539, ASSA 65673, 65691, Abloy	E1903-L	E2	5.84
	Schlage® 23-001, Primus Corbin-Russwin 2000-034	EF1903-C	E3	5.84
CYLINDRICAL IC CORES				
	Kit for 6 & 7 pin Marks, KSP, Best®, Falcon, Medeco® Keymark, Schlage® Small Format, 6 pin Sargent	HER1984	ER	5.84
	Kit for 6 & 7 pin Corbin Russwin	HER1984-G	ERG	5.84
	Kit for 6 & 7 pin Yale™ American Lever ONLY	EAR1989-Y	EMY	7.00
	6 pin Schlage® Large Format American Lever ONLY	EF1903-F19	CM	7.00

CAMS				
Straight cam for tubular, exit device, or mortise functions Z1 & Z4 only.				
	USE WITH OEM MORTISE CYLINDER	PART #	CODE	PRICE
	MARKS	2101	1	5.84
	Arrow/Sargent	2101-A	A1	5.84
	Corbin Russwin	2101-C	C1	5.84
	Schlage®	2101-S	S1	5.84

REQUEST TO EXIT (REX) CYLINDRICAL ELECTRIFIED LEVERSET

	ANSI-A156.2 • Grade 1 3 Hour Fire Rating		<p>Marks USA has developed the Grade 1 "Survivor" Series Cylindrical Lockset incorporating a Request to Exit (REX) switch in both Electrified and Storeroom functions. Activating the inside lever for egress initiates the built-in REX output, providing a momentary signal for the access control REX input, for alarm shunt during egress.</p>
EA195 Series Leverset w/American Lever			
			

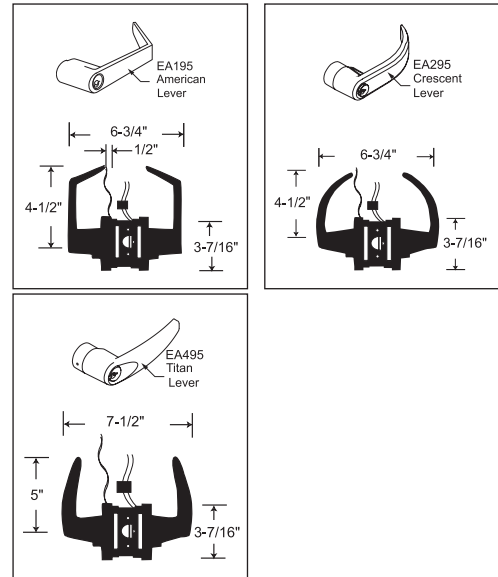

Standard Features

- Backsets: 2-3/4"; 2-3/8", 3-3/4" or 5" optional
- Latch #1834, Front: 1-1/8" x 2-1/4"; Throw: 9/16"; Stainless steel nose
- Levers: Solid cast Zamac w/ 1/2" return (except 395 & 495)
- Rose: Thru-bolted, 3-7/16" dia., spring loaded 2-#10 thru-bolts
- Strike: #1135, 4-7/8" ASA curved lip
- Door thickness: 1-5/8" to 1-7/8" (For 1-3/8" door use K1704 spacer)
- Cylinder: MARKS "C" keyway, 6 pin w/ 2 keys
- Request to Exit Switch: Single pole, double throw, 3 amp, 125 AC, wired either normally open or normally closed
- Electrified functions - 100% duty cycle, 24V/DC standard, supplied with bridge rectifier; 3 watts, .25amps
- 12V/DC Optional, Contact factory for additional options
- Features "The Clutch" • UL Listed, 3 hour fire rating

Electrified Locksets

LOCKSET & LEVER DESIGN	CON. CORE	IC CORE	FUNCTION	ANSI #	DESCRIPTION	FINISH GROUPS	
						26D	3, 4, 10, 10B, 26
EA195 American lever	F	RF	STOREROOM	F86	Latch by lever inside. Outside lever always locked.	417.30	473.73
EA295 Crescent lever							
EA495 Titan lever							
EA195 American lever	FEL	RFEL	ELECTRICALLY LOCKED	-	Outside always locked electrically. Open by key outside, switch or loss of power. Latch by lever inside.	572.80	616.11
EA295 Crescent lever							
EA495 Titan lever							
EA195 American lever	FEU	RFEU	ELECTRICALLY UNLOCKED	-	Outside always locked until unlocked by key or electrically energized. Latch by lever inside.	572.80	616.11
EA295 Crescent lever							
EA495 Titan lever							

LEVERSETS ARE PACKED 6 PER CASE

★ **Standard IC Core Models:** Interchangeable Core models for 6 or 7 pin cores (not included).
Accepts: Marks, Medeco KeyMark™, Falcon & Best®.
IC Core Tailpieces ARE Included.



How To Order Example for REX Leversets

EA195	F	/	26D	-	G3
1. Lockset Series	2. Marks Function	Slash	3. Finish	Dash	4. Options

LOCK SERIES

- ___ EA195
- ___ EA295
- ___ EA395
- ___ EA495

MARKS FUNCTION

- ___ F ___ RFEL
- ___ RF ___ FEU
- ___ FEL ___ RFEU

FINISH

- ___ 3 ___ 4
- ___ 10 ___ 10B
- ___ 26 ___ 26D

OPTIONS

ELECTRIFIED LOCKSETS

CYLINDRICAL LEVERSETS & MORTISE LOCKSETS

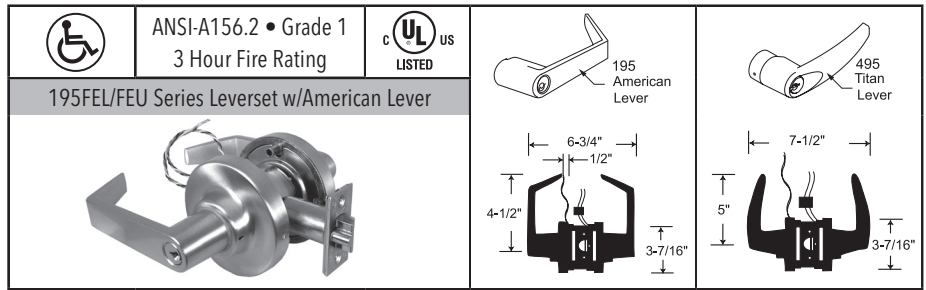

Series 195, 295, 495 Cylindrical Leverset Standard Features

- Backsets: 2-3/4", 2-3/8", 3-3/4", 5"
- Latch #1834, Front: 1-1/8" x 2-1/4"; Throw: 9/16"; Stainless steel nose
- Levers: Solid cast Zamac w/ 1/2" return
- Rose: Thru-bolted, 3-7/16" dia., spring loaded 2-#10 thru-bolts
- Strike: #1135, 4-7/8" ASA curved lip
- Door thickness: 1-5/8" to 1-7/8" (For 1-3/8" door use K1904 spacer)
- Cylinder: MARKS "C" keyway, 6 pin w/ 2 keys or IC Core housing
- Electrified functions - 100% duty cycle, 24V/AC supplied with bridge rectifier; 24V/DC, .21 Amps
- 12V/DC Optional, Contact factory for additional options
- Features "The Clutch"
- UL Listed, 3 hour fire rating

SERIES 195, 295, 495 GRADE 1 ELECTRIFIED CYLINDRICAL LEVERSETS				FINISH GROUPS	
COMMERCIAL CYLINDER	IC CORE CYLINDER	MARKS FUNCTION	DESCRIPTION	3, 26D	4, 10, 10B, 26
FEL	RFEL	ELECTRICALLY LOCKED (Fail Safe)	Outside always locked electrically. Open by key outside, switch or loss of power. Deadlocking latch by lever inside. Lever only.	451.42	508.51
FEU	RFEU	ELECTRICALLY UNLOCKED (Fail Secure)	Outside always locked until unlocked by key or electrically energized. Deadlocking latch by lever inside. Lever only.		

★ **Standard IC Core Models:** Interchangeable Core models for 6 or 7 pin cores (not included). **Accepts:** Marks, Medeco KeyMark™, Falcon & Best®. **IC Core Tailpieces ARE Included.**



Series 5 Electrified Mortise Lockset Standard Features

- 2-3/4" Backset ONLY
- 1" Stainless steel bolt throw
- 3/4" Latch throw (anti-friction) separator
- 1/2" Auxiliary latch throw
- Stamped steel case .090 thick., Zinc dichromate finish
- 1-1/4" x 8" Lock front, Adjustable bevel
- Steel hubs, 9/32" on diamond, 5/16" on square w/security separator
- 100% Duty Cycle 24V/DC, 12V/DC supplied with bridge rectifier (350 ma)



OPTIONS	CODE	PRICE
Auxiliary Latch	E3	23.00
Request to Exit Switch	W10	101.00
Key Override Sensor	W11	101.00
Request to Exit switch, Key Sensor & Bolt Sensor	W13	303.00
Bolt Sensor	W14	101.00
Latch Sensor	W15	101.00

SERIES 5 ELECTRIFIED MORTISE LOCKSET			FINISH GROUPS	
MARKS FUNCTION	DESCRIPTION		3, 32D	10, 10B, 32
EL: ELECTRICALLY LOCKED (Fail Safe)	Outside always locked electrically. Open by key outside, switch or loss of power. Auxiliary latch deadlocks latch. Inside always open.		564.13*	569.53*
EU: ELECTRICALLY UNLOCKED (Fail Secure)	Outside always locked until unlocked by key or electrically energized. Auxiliary latch deadlocks latch. Inside always open.			

* Lock Body Price ONLY. Due to numerous trim and finish options, please refer to the Marks USA Mortise Lockset Price Book.

Electrified Locksets

GATE LOCKS (Reversible)

US PAT.#4,875,725 "NO FALL OUT" FEATURE:
Parts will not fall out when cover is removed.
Replaces Multilock gate locks.

Swinging Gate Locks

- Standard Features**
- Easily reversible
 - Case, cast aluminum 3-5/8" x 6-1/4" x 1"
 - Bronze powder coat finish
 - Groove: 1/2" wide x 3/16" deep, all sides for wire gate insertion
 - 5 pin cylinder(s)
 - Lock only, no keeper furnished

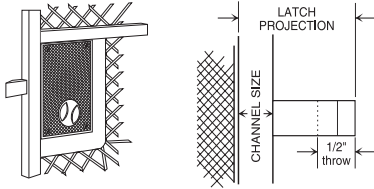

Single
Cylinder Model
*With cylinder
Suffix K
Add \$20

Double
Cylinder Model
*With cylinders
Suffix M
Add \$38

MODEL #	LATCH PROJECTION	CHANNEL SIZE	PRICE LESS CYL.*	WT. / LBS.
W3700	1-1/8"	1/2"	99.08	20
W3710	1-1/4"	5/8"	99.08	20
W3720	1-3/8"	3/4"	99.08	20
W3730	1-7/8"	1-1/4"	111.54	20
W3750	1-1/8"	1/2"	139.76	21
W3760	1-1/4"	5/8"	139.76	21
W3770	1-3/8"	3/4"	139.76	21
W3780	1-7/8"	1-1/4"	154.19	21

GATE LOCKS ARE PACKED 12 PER CASE

Sliding Gate Locks

- Standard Features**
- Easily reversible
 - Case, cast aluminum 3-5/8" x 6-1/4" x 1"
 - Bronze powder coat finish
 - Groove: 1/2" wide x 3/16" deep, all sides for wire gate insertion
 - 5 pin cylinder(s)
 - Lock only, no keeper furnished

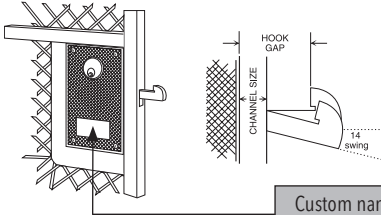

Single
Cylinder Model
*With cylinder
Suffix K
Add \$20

Double
Cylinder Model
*With cylinders
Suffix M
Add \$38

MODEL #	HOOK GAP	CHANNEL SIZE	PRICE LESS CYL.*	WT. / LBS.
W3800	.825"	1/2"	99.08	21
W3810	.950"	5/8"	99.08	22
W3820	1.075"	3/4"	99.08	21
W3830	1.625"	1-1/4"	111.54	22
W3850	.825"	1/2"	139.76	22
W3860	.950"	5/8"	139.76	22
W3870	1.075"	3/4"	139.76	22
W3880	1.625"	1-1/4"	154.19	22

GATE LOCKS ARE PACKED 12 PER CASE

Custom nameplate available.
Consult factory.

Parts

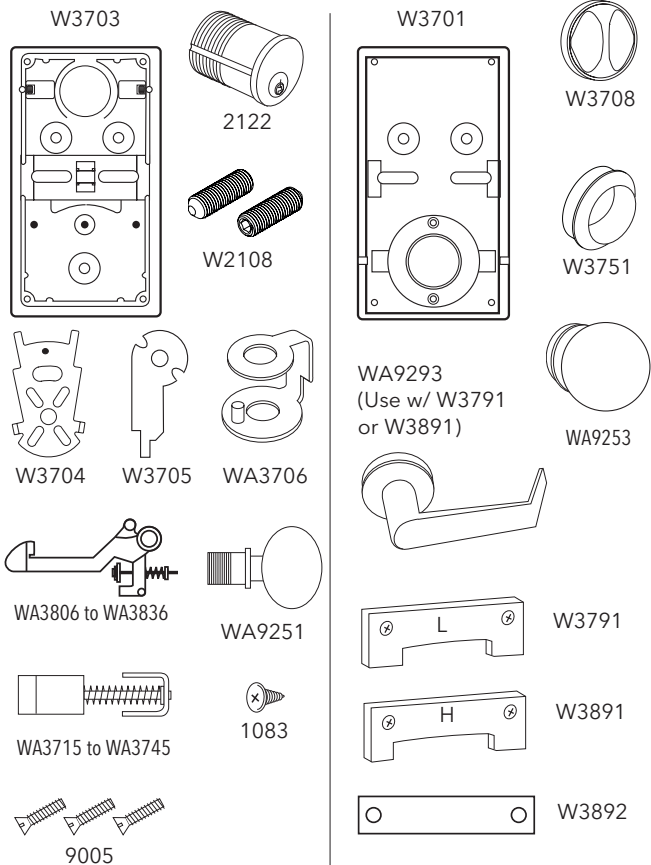

PART #	DESCRIPTION	PRICE
1083	Retainer/fork screw 15/16"	0.48
2122	Mortise cylinder	33.86
W2108	Cylinder set screw	0.48
9005	Case screw	0.48
W3701	Cover	33.86
W3703	Case	53.10
W3704	Fork	6.93
W3705	Latch lever	6.16
W3708	Turnpiece	17.70
W3751	Double cylinder collar with set screw	33.86
W3791	Lever stop plate - Swinging gate lock (w/W3892)	11.54
W3891	Lever stop plate - Sliding gate lock (w/W3892)	11.54
W3892	Lever slide cover	4.62
WA3706	Latch adapter	11.54
WA3715	Latch assembly - 1-1/8" projection	25.40
WA3725	Latch assembly - 1-1/4" projection	25.40
WA3735	Latch assembly - 1-3/8" projection	25.40
WA3745	Latch assembly - 1-7/8" projection	33.86
WA3806	Hook assembly - .825" gap	33.86
WA3816	Hook assembly - .950" gap	33.86
WA3826	Hook assembly - 1.075" gap	33.86
WA3836Z	Hook assembly - 1.625" gap	42.33
WA9251	Exterior knob assembly	69.26
WA9253	Interior knob assembly	69.26
WA9293	Interior lever assembly (with W3791 & W3891)	102.35

SERIES HA113 CUSTOM LOCK DIVISION

HOUSING AUTHORITY MORTISE LOCKSET

SERIES HA113			BHMA CERTIFIED
			FINISH GROUPS
MARKS #	FUNCTION	ANSI #	20A
KEYED SINGLE CYLINDER, NO DEADBOLT			
D	OFFICE VESTIBULE		379.24
DW	VESTIBULE		
E	OFFICE	F04	
EW	STOREROOM	F07	
GL	INST. PRIVACY	F26	
J	CLASSROOM	F05	
JM, JR	HOSPITAL (HOLDBACK)	F06	
EL	ELECTRICALLY LOCKED		755.87
EU	ELECTRICALLY UNLOCKED		
KEYED SINGLE CYLINDER, WITH DEADBOLT			
A	ENTRANCE	F08, F10	389.09
B	ENTRANCE	F21	
F	DORMITORY	F12	
FS	DORMITORY		
FW	DORMITORY	F13	
FD	APARTMENT	F20	417.30
H	HOTEL	F15	
LH	SPEC. PRIVACY		
KEYED DOUBLE CYLINDER, NO DEADBOLT			
G	ENTRANCE	F09	417.30
GC	INTRUDER LATCHBOLT	F32	
GG	CLASSROOM SECURITY		
GR	CLASSROOM SECURITY w/HOLDBACK		
WW	INSTITUTION	F30	
KEYED DOUBLE CYLINDER, WITH DEADBOLT			
AC	ENTRANCE	F35	417.30
C	STOREROOM	F14	
FC	INTRUDER DEADBOLT	F34	
FA	DORMITORY	F11	
FX	DORMITORY	F33	
KEYLESS			
N	PASSAGE	F01	331.35
L	BATHROOM	F02	366.78
LF	PRIVACY	F19	
LJ	PRIVACY	F22	402.86
EX	EXIT	F31	379.24

For pricing, finishes and availability, consult factory

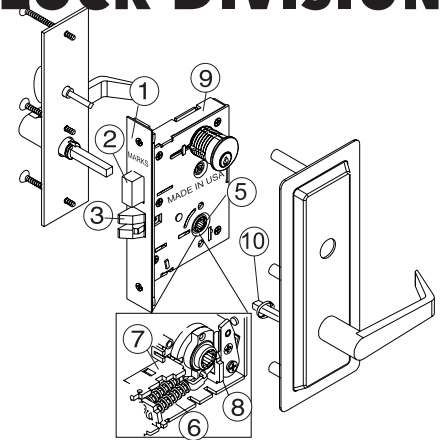

Performance Specifications:

Life Test: 1,500,000 cycles minimum.

ANSI Test: Meets or exceeds all operational and security tests of ANSI specifications A156.13-2005 for series 1000, Grade 1.

Fire Test: UL Listed, 3 hour fire rated.
Meets ADA requirements.



Trim Specifications:

"Barrier" Thru-bolted steel lever/plate assemblies with brass machined lever bearings. Screwless forged American levers, 4-1/2" long to meet ADA requirements, fastened to plates with hardened snap rings. Spring loaded 5/16" spindles (no set screws). Dark bronze powder coated finish.

Exterior: Wrought steel lever/plate assembly.
10-1/8" x 4" x 5/64" with 3 concealed welded thru-posts. Center post braces lock body for proper alignment in 1-3/4" thick door. Plate covers cylinder with only the keyway exposed.

Optional Exterior: Plate prepared for IC core cylinder.

Interior: Flat steel lever/plate assembly. 10-3/4" x 3-1/8" x 3/32" thick with 3 each 1/4"-20 mounting bolts. Center bolt passes through lock body to integrate trim with lock.

Cylinder: 1-1/8" long, 6 pin, solid brass with spacing collar concealed under exterior "Barrier" plate; 2 keys.

Strike: 4-7/8" x 1-1/4" x 3/32" thick, 5/8" curved lip. Conforms to ANSI spec., A115.1.

Door Thickness: 1-3/4" standard. Extended range available.

Lock Specifications: 5 Series (2-3/4" Backset)

- Lock Front:** Adjustable bevel steel backplate 1-1/4" x 8" x 7/64" thick. Cover plate 1/16" thick.
- Deadbolt:** Stainless steel w/hardened roll pins, 1" throw.
- Latch:** Solid stainless steel with antifriction latch lever, 3/4" throw (reversible).
- Auxiliary deadlatch:** 1/2" throw (reversible) - (not shown).
- Hubs:** Steel, 9/32" on diamond, 5/16" on square w/security separator.
- Independent exterior and interior lever support springs.
- Hub Follower:** (to lock hub) steel 1/8" thick.
- Hub Stop:** (to limit lever travel) steel 1/8" thick.
- Case:** Stamped steel 3/32" thick, zinc dichromate finish.
- Spindles:** Independent spring-loaded spindles, 5/16" square.

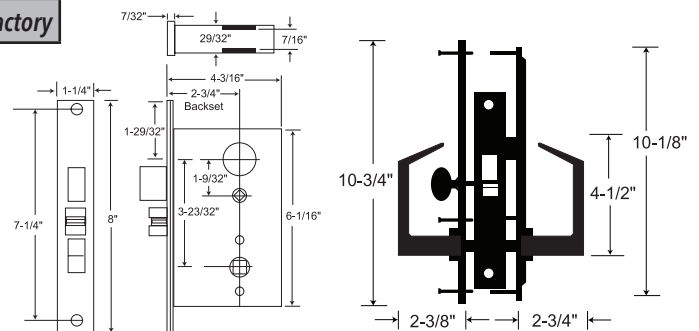

CUSTOM LOCK DIVISION

MAXIMUM SECURITY MORTISE LOCKSET

Series LA318GJ



PERFORMANCE SPECIFICATIONS:

LIFE TEST: 1,500,000 cycles, minimum

STRENGTH TEST: 530 inch lbs. torque on exterior lever. When applied, lockset remains locked. (Torque of over 550 inch lbs. will cause spindle failure. However, lockset remains locked once spindle is replaced, lockset is fully operational.)

ANSI TEST: Certified to meet or exceed all operational and security tests of ANSI/BHMA A156.13-2012 for series 1000, Grade 1

FIRE TEST: UL listed, 3 hour fire rated.
Meets ADA requirements.



WARRANTY: Lifetime mechanical limited warranty

All other functions available with latch, deadlatch and deadbolt combinations

FUNCTION SPECIFICATION: LA318GJ CLASSROOM INTRUDER

Latch by lever either side except when outside lever is locked from inside or outside by key. When locked, exterior key will retract latchbolt. Outside key locks or unlocks exterior lever. Inside key is single acting in one direction and will lock exterior lever only; will not unlock exterior lever. Auxiliary latch deadlocks latch. Inside always free for egress

TRIM: Cast satin stainless steel escutcheon 8-1/2"x2-3/4"x7/16". Recess in escutcheon to accept cylinder with rotating security cylinder ring. Cast screwless satin stainless steel lever handles to within 1/2" from face of door secured to escutcheon plate with hardened steel retainer ring. Lever handle, with spring-loaded torque sensitive 5/16" spindle. Integral torque override preventer recessed into escutcheon plate. Spindle will yield if excessive torque applied, preventing any damage to lock body.

EXTERIOR: Two 1/4" diameter threaded thru posts.

Two 1/4" diameter center posts pass thru lock body, automatically aligning trim.

INTERIOR: Two #10-32 phillips head stainless steel mounting thru bolts. Escutcheon with "LOCK" and directional arrow engraved and black filled near cylinder location. Occupancy indicator recessed into escutcheon plate. Indicator window to display unlocked (green day-glo) and LocDown™ (red day-glo) positions.

CYLINDERS: Two 1-1/8", 6-pin solid brass with 2101 cam int., 2105 cam ext., with two keys. Outside cylinder rotates in both directions. Inside cylinder rotates in one direction only. Cams supplied to accommodate Corbin™, Sargent™ and Schlage™ cylinders.

STRIKE: 4-7/8" X 1-1/4" X 3/32" thick, 5/8" curved lip.

Conforms to ANSI spec. 115.1.

DOOR THICKNESS: 1-3/4"

Lock Body: 5 series "GJ" function double cylinder lock. Lock handing completely reversible without opening lock case.

1. Lock Front - Adjustable bevel steel backplate 1 1/4"x 8 x 7/64" thick. Cover plate 1/16" thick, with phillips screws
2. Latch - solid stainless steel w/ antifriction latch lever 3/4" throw
3. Auxiliary Deadlatch - 1/2" throw
4. Case - stamped steel 3/32" thick
5. Hubs - Steel, 9/32" on diamond, 5/16" on square w/ security separator
6. Independent exterior and interior lever support springs

LA318			FINISH GROUPS
MARKS #	FUNCTION	ANSI #	32D
KEYED SINGLE CYLINDER, NO DEADBOLT			
D	OFFICE VESTIBULE		561.00
DW	VESTIBULE		
E	OFFICE	F04	
EW	STOREROOM	F07	
GL	INST. PRIVACY	F26	
J	CLASSROOM	F05	
JM, JR	HOSPITAL (HOLDBACK)	F06	
GS	CLASSROOM SECURITY T-TURN		608.24
EL	ELECTRICALLY LOCKED		772.27
EU	ELECTRICALLY UNLOCKED		
KEYED SINGLE CYLINDER, WITH DEADBOLT			
A	ENTRANCE	F08, F10	517.18
B	ENTRANCE	F21	
F	DORMITORY	F12	
FS	DORMITORY		
FW	DORMITORY	F13	
FD	APARTMENT	F20	585.27
H	HOTEL	F15	
LH	SPEC. PRIVACY		
KEYED DOUBLE CYLINDER, NO DEADBOLT			
G	ENTRANCE	F09	591.76
GC	INTRUDER LATCHBOLT	F32	
GG	CLASSROOM SECURITY		
GR	CLASSROOM SECURITY w/HOLDBACK		
WW	INSTITUTION	F30	608.24
GJ	CLASSROOM SECURITY		
KEYED DOUBLE CYLINDER, WITH DEADBOLT			
AC	ENTRANCE	F35	591.76
C	STOREROOM	F14	
FC	INTRUDER DEADBOLT	F34	
FA	DORMITORY	F11	
FX	DORMITORY	F33	
KEYLESS			
N	PASSAGE	F01	457.33
L	BATHROOM	F02	495.38
LF	PRIVACY	F19	
LJ	PRIVACY	F22	570.18
EX	EXIT	F31	533.44
DUMMY TRIM			
DI, DO	DUMMY TRIM INSIDE/OUTSIDE		251.96
DT	DUMMY TRIM		504.57

For pricing, finishes and availability, consult factory

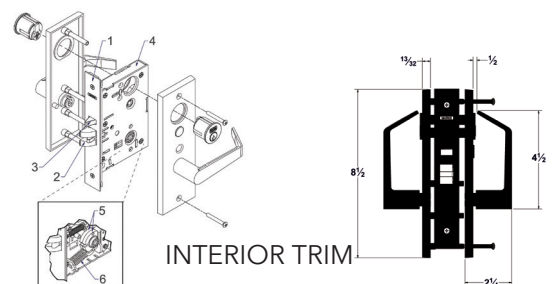

INTERIOR TRIM

Custom Locksets

SERIES BE101 & LA118 CUSTOM LOCK DIVISION

MAXIMUM SECURITY MORTISE LOCKSET

SERIES BE101 & LA118			BHMA [™] CERTIFIED	
			FINISH GROUPS	
MARKS #	FUNCTION	ANSI #	32D	3, 10, 10B
KEYED SINGLE CYLINDER, NO DEADBOLT				
D	OFFICE VESTIBULE		526.88	549.84
DW	VESTIBULE			
E	OFFICE	F04		
EW	STOREROOM	F07		
GL	INST. PRIVACY	F26		
J	CLASSROOM	F05		
JM, JR	HOSPITAL (HOLDBACK)	F06		
EL	ELECTRICALLY LOCKED		749.31	806.39
EU	ELECTRICALLY UNLOCKED			
KEYED SINGLE CYLINDER, WITH DEADBOLT				
A	ENTRANCE	F08, F10	536.72	561.00
B	ENTRANCE	F21		
F	DORMITORY	F12		
FS	DORMITORY			
FW	DORMITORY	F13		
FD	APARTMENT	F20	552.46	576.74
H	HOTEL	F15		
LH	SPEC. PRIVACY			
KEYED DOUBLE CYLINDER, NO DEADBOLT				
G	ENTRANCE	F09	559.68	581.99
GC	INTRUDER LATCHBOLT	F32		
GG	CLASSROOM SECURITY			
GR	CLASSROOM SECURITY w/HOLDBACK			
WW	INSTITUTION	F30		
KEYED DOUBLE CYLINDER, WITH DEADBOLT				
AC	ENTRANCE	F35	559.68	581.99
C	STOREROOM	F14		
FC	INTRUDER DEADBOLT	F34		
FA	DORMITORY	F11		
FX	DORMITORY	F33		
KEYLESS				
N	PASSAGE	F01	457.33	479.63
L	BATHROOM	F02	536.72	561.00
LF	PRIVACY	F19		
LJ	PRIVACY	F22	496.69	520.32
EX	EXIT	F31	496.69	520.32
DUMMY TRIM				
DI, DO	DUMMY TRIM INSIDE/OUTSIDE		230.96	242.77
DT	DUMMY TRIM		462.57	520.32

For pricing, finishes and availability, consult factory

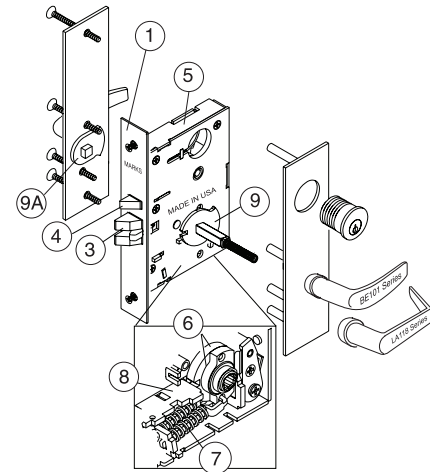

Performance Specifications:

Life Test: 1,500,000 cycles minimum.

ANSI Test: Meets or exceeds all operational and security tests of ANSI specifications A156.13-2005 for series 1000, Grade 1.

Fire Test: UL Listed, 3 hour fire rated.

Meets ADA requirements.



Trim Specifications:

"Barrier" Thru-bolted steel lever/plate assemblies with brass machined lever bearings. Screwless forged American levers, 4-1/2" long to meet ADA requirements, fastened to plates with hardened snap rings. Spring loaded 5/16" spindles (no set screws). Dark bronze powder coated finish.

Exterior: Wrought steel lever/plate assembly. 10-1/8" x 4" x 5/64" with 3 concealed welded thru-posts. Center post braces lock body for proper alignment in 1-3/4" thick door. Plate covers cylinder with only the keyway exposed.

Optional Exterior: Plate prepared for IC core cylinder.

Interior: Flat steel lever/plate assembly. 10-3/4" x 3-1/8" x 3/32" thick with 3 each 1/4"-20 mounting bolts. Center bolt passes through lock body to integrate trim with lock.

Cylinder: 1-1/8" long, 6 pin, solid brass with spacing collar concealed under exterior "Barrier" plate; 2 keys.

Strike: 4-7/8" x 1-1/4" x 3/32" thick, 5/8" curved lip. Conforms to ANSI spec., A115.1.

Door Thickness: 1-3/4" standard. Extended range available.

Lock Specifications: 5 Series (2-3/4" Backset)

1. Lock Front: Adjustable bevel steel backplate 1-1/4" x 8" x 7/64" thick. Cover plate 1/16" thick.

2. Deadbolt: Stainless steel w/hardened roll pins, 1" throw.

3. Latch: Solid stainless steel with antifriction latch lever, 3/4" throw (reversible).

4. Auxiliary deadlatch: 1/2" throw (reversible) - (not shown).

5. Hubs: Steel, 9/32" on diamond, 5/16" on square w/security separator.

6. Independent exterior and interior lever support springs.

7. Hub Follower: (to lock hub) steel 1/8" thick.

8. Hub Stop: (to limit lever travel) steel 1/8" thick.

9. Case: Stamped steel 3/32" thick, zinc dichromate finish.

10. Spindles: Independent spring-loaded spindles, 5/16" square.

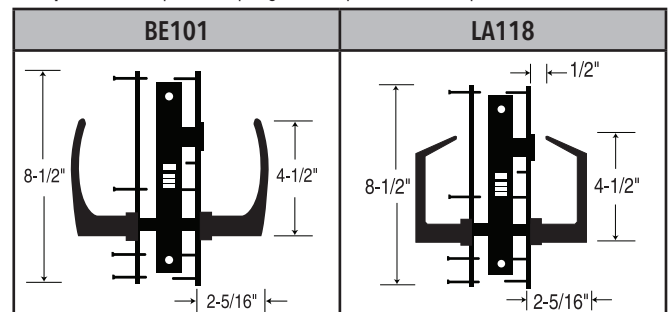

CUSTOM LOCK DIVISION
MAXIMUM SECURITY MORTISE LOCKSET

LocDown™
 by **MARKSUSA®**

Specially Locksets
 Contact Customer Service for Prices

PERFORMANCE SPECIFICATIONS:

- LIFE TEST:** 1,500,000 cycles, minimum
- STRENGTH TEST:** 530 inch lbs. torque on exterior lever. When applied, lockset remains locked. (Torque of over 550 inch lbs. will cause spindle failure. However, lockset remains locked once spindle is replaced, lockset is fully operational.)
- ANSI TEST:** Certified to meet or exceed all operational and security tests of ANSI/BHMA A156.13-2012 for series 1000, Grade 1
- FIRE TEST:** UL listed, 3 hour fire rated. Meets ADA requirements.
- WARRANTY:** Lifetime mechanical limited warranty
 All other functions available with latch, deadlatch and deadbolt combinations



Model #: LA318VJM/32D



Lock Function: Deadlock

Deadlocking latch by key outside. Inside lever retracts deadlocking latch. Latch is in hold-back by turning inside lever and inserting key in outside mortise cylinder. Indicator on inside escutcheon shows green when in latch hold-back. Turning key in inside mortise cylinder in the direction of the arrow will release the latch, change the indicator to red and secure the main door from the outside.

Custom Locksets

Model #: LA118VCR/32D

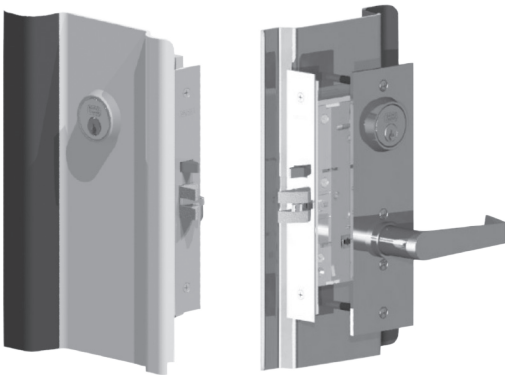

Lock Function: Deadlock

Latch retracted by key outside and lever inside accept when locked by key either side. Inside lever retracts and holds latch in retracted position by rotating key in inside or o/s cylinder. Inside lever can be locked (rigid) or unlocked. Deadlocking latch.

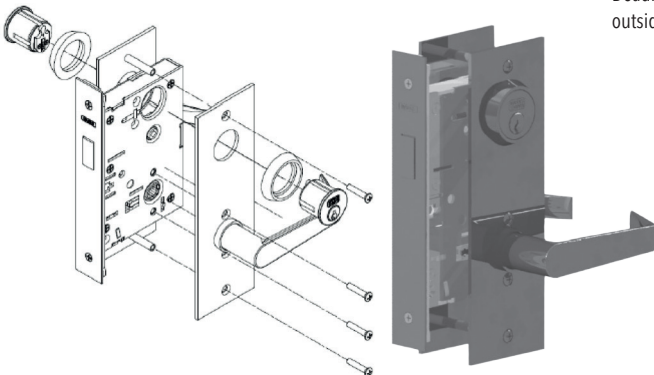

Model #: LA118ATF/32D



Lock Function: Deadlock

Deadbolt by key either side. Inside knob/lever retracts deadbolt for emergency egress, outside knob/lever always rigid

GRADE 1 195BH LifeSaver™ D-LIG SLIDE CYLINDRICAL LOCKSETS

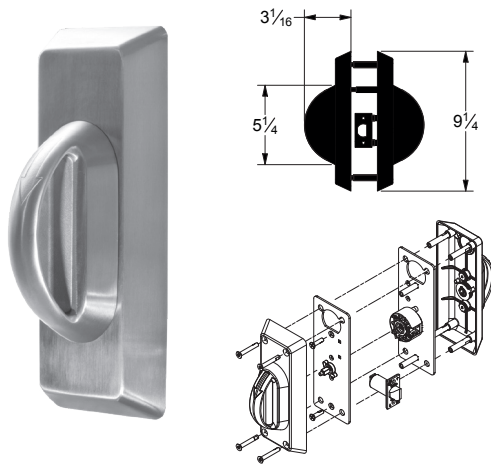
BHMA CERTIFIED		ANSI-A156.2 • Grade 1 3 Hour Fire Rating		195BH SERIES
195SS Series Leversets Shown Below				Standard Features
				<ul style="list-style-type: none"> • Rating: ANSI A156.2 Grade 1, UL Listed 3Hr Fire Rating • 5- Point Ligature Resistant slide Trim • Backset: 2 3/4" Standard, 2 3/8", 3 3/4" and 5" available • Latch: #1834, stainless Steel Nose • Ergonomic solid cast Stainless Steel Slide, Slides down freely in the locked or unlocked position • Escutcheon Plate solid cast Stainless Steel thru bolted for strength and easy installation • Designed to meet BHMA 156.34 Anti Ligature Trim Standard • Tamper Resistant mounting screws • Strike: #1135, 4 7/8" ASA curved lip Strike • Door Thickness: 1 3/4" • Cylinder: Marks C Keyway, 6 pin w/2 keys - Available in IC and All OEM cylinder preps • Marks Hi-Security Cylinder available • Marks Stainless Steel Retractor - Long life 3X the BHMA Grade 1 cycle Standard • Antimicrobial Finish available - Code AM • Marks Lifetime Mechanical Warranty • Available in Most BHMA ANSI Functions

SERIES 195BH					
MARKS #		DESCRIPTION	ANSI #	FINISH	PRICE
COMM. CYL.	ACCEPTS IC CORE CYL.*				
N	-	PASSAGE	F75	32D	789.03
L	-	PRIVACY	F76		789.03
B	RB	ENTRY	F82A		891.95
S	RS	CLASSROOM	F84		891.95
F	RF	STOREROOM	F86		891.95
DW	RDW	INSTITUTION	F87		994.87
DB	RDB	CLASSROOM INTRUDER	F110		960.56
DO	-	DUMMY TRIM OUTSIDE	-		377.36
DT	-	FULL DUMMY TRIM	-		754.73
NB	-	COMM. PASSAGE	F111		768.45
FB	RFB	COMM. STOREROOM	F112		816.47
SB	RSB	COMM. CLASSROOM	F113		816.47
FEL	RFEL	ELECTRICALLY LOCKED			994.87
FEU	RFEU	ELECTRICALLY UNLOCKED			994.87

PACKED 6 PER CASE

Institutional Life Safety

OPTIONS	CODE	PRICE	OPTIONS	CODE	PRICE
For 2" doors	D1	NC	Sargent conventional cylinder	F8	15.00
For 2-1/4" doors, Consult Factory	D2	48.00	Corbin Russwin conventional cylinder	F9	15.00
Over 2-1/4" - 4" thickness	D9	409.00	Corbin Russwin 6 pin IC core	F12	22.00
2-3/8" backset, 1" x 2-1/4" face	E6	NC	Yale/Accentra 6 pin IC core	F14	15.00
5" backset, 9/16" throw, Gr. 1	E9	30.00	Sargent IC core	F20	15.00
3-3/4" backset, 9/16" throw, Gr. 1	E10	30.00	Medeco IC core large format	F21	15.00
Less cylinder	G3	-10.00	Schlage Large Format IC Core	F19	15.00
2-3/4" "T" strike	S3	NC	7-Pin Yale/Accentra IC Core	F15	15.00

TAILPIECES FOR 195BH			
P/N	FITS	OPTION CODE	PRICE
MH119	YALE/ACCENTRA / MEDECO IC CORE	F14, F15, F21	7.00
MH140	CONVENTIONAL (K.I.L.) CYL	N/A	7.00
MH144	SIFC	R, F20	7.00
MH146	CORBIN RUSSWIN IC	F12, F13	7.00
MH1903S-C	SCHLAGE IC / CORBIN K.I.L.	F19, F9	7.00

***Standard & HI-SECURITY™ IC Core Models:** Interchangeable Core models for 6 or 7 pin cores (not included). **Accepts:** Marks, Marks HI-SECURITY™, Medeco®, KeyMark™, Falcon, Schlage® small format & Best®. **IC Core Tailpieces ARE Included.**



**HI-SECURITY
OPTION**

**Antimicrobial Finish Available
Option Code: AM**

GRADE 1 SERIES 5BH29 D-LIG SLIDE MORTISE LOCKSET

INSTITUTIONAL LifeSaver™ MORTISE LOCKSETS

BHMA CERTIFIED		SERIES 5		UL LISTED		FINISH 32D	
MARKS #	FUNCTION	ANSI #	5BH				
KEYED SINGLE CYLINDER, NO DEADBOLT							
D	OFFICE VEST.		1166.39				
DW	VESTIBULE						
E	OFFICE	F04					
EW	STOREROOM	F07					
J	CLASSROOM	F05					
GL	INSTIT. PRIVACY	F26	1392.81				
EL	ELECTRICALLY LOCKED						
EU	ELECTRICALLY UNLOCKED						
KEYED SINGLE CYLINDER, WITH DEADBOLT							
A	ENTRANCE	F08, F10	1176.00				
B	ENTRANCE	F21					
F	DORMITORY	F12					
FS	DORMITORY						
FW	DORMITORY	F13					
KEYED DOUBLE CYLINDER, NO DEADBOLT							
G	APARTMENT	F09	1197.96				
GC	INTRUDER LATCHBOLT	F32					
GG	CLASSROOM SECURITY						
WW	INSTITUTIONAL	F30					
KEYED DOUBLE CYLINDER, WITH DEADBOLT							
AC	ENTRANCE	F35	1197.96				
C	STOREROOM	F14					
CT							
FA	DORMITORY	F11					
FX	DORMITORY	F33					
KEYLESS							
N	PASSAGE	F01	1099.84				
L	BATHROOM	F02	1176.00				
LF	PRIVACY	F19					
LJ	PRIVACY	F22	1138.26				
EX	EXIT	F31					
DUMMY TRIM							
DI	DUMMY TRIM INSIDE		343.06				
DO	DUMMY TRIM OUTSIDE						
DT	FULLY DUMMY						
768.45							

★ **Standard & HI-SECURITY™ IC Core Models:**
 Interchangeable Core models for 6 or 7 pin cores (not included).
Accepts: Marks, Marks HI-SECURITY™, Medeco®, KeyMark™, Falcon,
 Schlage® small format & Best®. **IC Core Tailpieces ARE Included.**

**Antimicrobial
 Finish Available
 Option Code: AM**

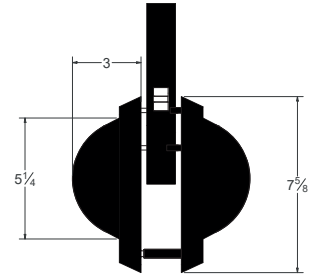
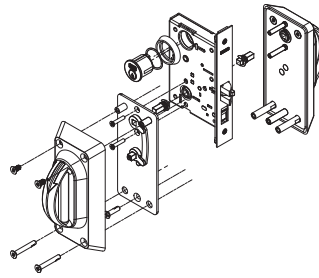

Performance Specifications:

- **Rating:** ANSI A156.13 Grade 1, UL Listed 3Hr Fire Rating
- 5- Point Ligature Resistant slide Trim
- **Backset:** 2 3/4" Standard, 2 1/2" Consult Factory
- **Latch:** #1834, stainless Steel Nose
- **Ergonomic solid cast Stainless Steel Slide,** Slides down freely in the locked or unlocked position
- **Escutcheon Plate solid cast Stainless Steel** thru bolted for strength and easy installation
- Designed to meet **BHMA 156.34 Anti Ligature Trim Standard**
- Tamper Resistant mounting screws
- Ligature Resistant ADA Thumbturn available where applicable
- **Strike:** #1135, 4 7/8" ASA curved lip Strike
- **Door Thickness:** 1 3/4"
- **Cylinder:** Marks C Keyway, 6 pin w/2 keys
- Available in IC
- Marks Hi-Security Cylinder available
- **Marks Stainless Steel Retractor** - Long life 3X the BHMA Grade 1 cycle Standard
- Antimicrobial Finish available - Code AM
- **Marks Lifetime Mechanical Warranty**
- Available in Most BHMA ANSI Functions

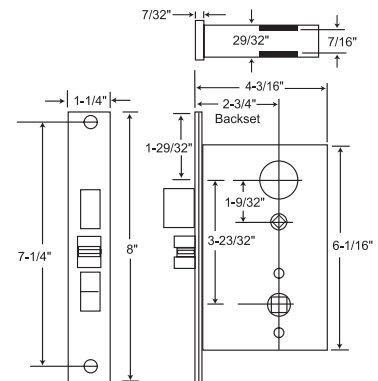

How To Order

5BH29	J	/	32D	-	G3
1. Lockset Series	2. Marks Function	Slash	3. Finish	Dash	4. Options

GRADE 1 195SS LifeSaver™ CYLINDRICAL LEVERSETS

		ANSI-A156.2 • Grade 1 3 Hour Fire Rating		195SS SERIES
195SS Series Leversets Shown Below			Standard Features	
			<ul style="list-style-type: none"> • ANSI-A156.2 Grade 1, UL listed 3 Hr. Fire Rating • Backset: 2-3/4" Standard, 2-3/8", 3-3/4", 5" Available • Latch #1834, stainless steel nose • Levers: Solid cast stainless steel. Levers Rotate up & down freely in locked or unlocked position • Levers recessed into solid stainless steel roses eliminating any open gap • Roses: Thru-bolted, spring loaded, #10 thru-bolts • Strike: #1135, 4-7/8" ASA curved lip strike • Door thickness: 1-3/4" +/- 1/16" • Cylinder: MARKS "C" keyway, 6 pin w/ 2 keys • Stainless steel retractor 	

SERIES 1SS19					
MARKS #		DESCRIPTION	ANSI #	FINISH	PRICE
COMM. CYL.	ACCEPTS IC CORE CYL.*				
N	-	PASSAGE	F75	32D	574.95
L	-	PRIVACY	F76		590.06
LK	-	PRIVACY	F76 MOD.		608.58
P	-	PATIO	F77		586.63
DC	RDC	COMMUNICATING	F80		631.22
B	RB	ENTRY	F82A		601.72
AQ	-	EXIT	F83		593.49
S	RS	CLASSROOM	F84		601.72
F	RF	STOREROOM	F86		601.72
DW	RDW	INSTITUTION	F87		631.22
DA	RDA	VESTIBULE	F88		631.22
FQ	-	EXIT	F89		593.49
T	-	CORRIDOR	F90		608.58
TK	-	HOSPITAL/PRIV.	F90 MOD.		586.63
GB	RGB	STORE DOOR	F91		608.58
BS	RBS	SVC. STATION LOCK	F92		638.09
DO	-	DUMMY TRIM OUTSIDE	-		474.79
DT	-	FULL DUMMY TRIM	-		545.46
NB	-	COMM. PASSAGE	F111		560.55
FB	RFB	COMM. STOREROOM	F112		596.92
SB	RSB	COMM. CLASSROOM	F113	596.92	
FEL	RFEL	ELECTRICALLY LOCKED		720.42	
FEU	RFEU	ELECTRICALLY UNLOCKED		720.42	

PACKED 6 PER CASE

OPTIONS	CODE	PRICE
For 2" doors Consult Factory	D1	NC
For 2-1/4" doors, Consult Factory	D2	48.00
Over 2-1/4" - 4" thickness	D9	409.00
2-3/8" backset, 1" x 2-1/4" face	E6	NC
5" backset, 9/16" throw, Gr. 1 Consult Factory	E9	30.00
3-3/4" backset, 9/16" throw, Gr. 1	E10	30.00
Less cylinder	G3	-10.00
2-3/4" "T" strike	S3	9.00
Spacer for K1904GB/SS1	195SS	263.00

OPTIONS	CODE	PRICE
Sargent conventional cylinder	F8	15.00
Corbin Russwin conventional cylinder	F9	15.00
Corbin Russwin 6 pin IC core	F12	22.00
Yale/Accentra 6 pin IC core	F14	15.00
Sargent IC core	F20	15.00
Medeco IC core large format	F21	15.00

How To Order

195SS	F	/	32D	-	G3
1. <i>Lockset Series</i>	2. <i>Marks Function</i>	3. <i>Slash</i>	3. <i>Finish</i>	4. <i>Dash</i>	4. <i>Options</i>

★ **Standard & HI-SECURITY™ IC Core Models:** Interchangeable Core models for 6 or 7 pin cores (not included). **Accepts:** Marks, Marks HI-SECURITY™, Medeco®, KeyMark™, Falcon, Schlage® small format & Best®. **IC Core Tailpieces ARE Included.**



Antimicrobial Finish Available
Option Code: AM

Institutional Life Safety

SERIES 5SS19 LEVER

INSTITUTIONAL LifeSaver™ MORTISE LOCKSETS

BMA CERTIFIED		SERIES 5		UL LISTED US		FINISH 32D	
MARKS #		FUNCTION		ANSI #		SS19 Lever	
KEYED SINGLE CYLINDER, NO DEADBOLT							
D	OFFICE VEST.					753.35	
DW	VESTIBULE						
E	OFFICE		F04				
EW	STOREROOM		F07				
J	CLASSROOM		F05				
GL	INSTIT. PRIVACY		F26				
EL	ELECTRICALLY LOCKED					972.91	
EU	ELECTRICALLY UNLOCKED						
KEYED SINGLE CYLINDER, WITH DEADBOLT							
A	ENTRANCE		F08, F10			874.33	
B	ENTRANCE		F21				
F	DORMITORY		F12				
FS	DORMITORY						
FW	DORMITORY		F13				
KEYED DOUBLE CYLINDER, NO DEADBOLT							
G	APARTMENT		F09			773.94	
GC	INTRUDER LATCHBOLT		F32				
GG	CLASSROOM SECURITY						
WW	INSTITUTIONAL		F30				
KEYED DOUBLE CYLINDER, WITH DEADBOLT							
AC	ENTRANCE		F35			773.94	
C	STOREROOM		F14				
FA	DORMITORY		F11				
FX	DORMITORY		F33				
KEYLESS							
N	PASSAGE		F01			725.91	
L	BATHROOM		F02			863.17	
LF	PRIVACY		F19				
LJ	PRIVACY		F22			883.72	
EX	EXIT		F31				
DUMMY TRIM							
DI	DUMMY TRIM INSIDE					400.69	
DO	DUMMY TRIM OUTSIDE						
DT	FULLY DUMMY						

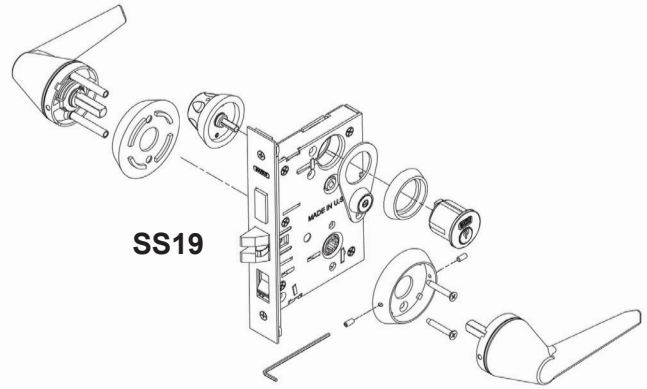

Performance Specifications:

Life Test: 1,500,000 cycles minimum.

ANSI Test: Meets or exceeds all operational and security tests of ANSI specifications A156.13-2005 for series 5000, Grade 1.

Trim Specifications:

Exterior & Interior Trim:

- Solid stainless steel interior and exterior tapered levers recessed into thru-bolted roses.
- Safety lever for handicapped access on clutch operated Mortise lock.
- Ergonomically designed grooved turn knob for deadbolt functions.

Cylinder: Solid stainless steel cylinders with solid stainless steel security collars; Optional HI-SECURITY™ cylinders available

Strike: 4-7/8" curved lip stainless steel w/tamperproof screws

Door Thickness: 1-3/4" standard; Extended range available

Door Prep: ANSI A115.1 lock face cutout, with 2-1/8" through hole for knob/rose assembly

Lock Specifications: 5 Series (2-3/4" Backset)

Lock Front: Adjustable bevel steel backplate 1-1/4" x 8" x 7/64" thick, Cover plate 1/16" thick with tamper proof screws

Latch: Solid stainless steel with antifriction latch lever, 3/4" throw (reversible)

Levers: Solid cast stainless steel. Levers Rotate up & down freely in locked or unlocked position

Aux. Deadlatch: 1/2" throw, (reversible)

Case: Stamped steel 3/32" thick, zinc dichromate finish

Hubs: Steel, 9/32" on diamond, 5/16" on square w/security separator

Hub Lock Arm: (to lock hub) Steel 1/8" thick

Spindles: Independent spring-loaded spindles

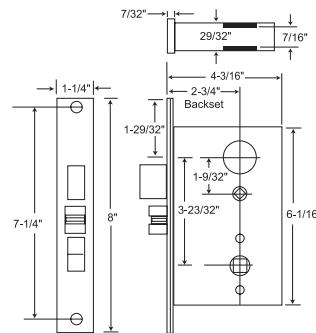

Antimicrobial
Finish Available
Option Code: AM

★ Standard & HI-SECURITY™ IC Core Models:

Interchangeable Core models for 6 or 7 pin cores (not included).

Accepts: Marks, Marks HI-SECURITY™, Medeco®, KeyMark™, Falcon, Schlage® small format & Best®. **IC Core Tailpieces ARE Included.**

How To Order

5SS19 Lever	J	/	32D	-	G3
1. Lockset Series	2. Marks Function	Slash	3. Finish	Dash	4. Options

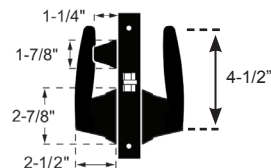

SERIES 31SS55 INSTITUTIONAL LifeSaver™ LOCKSETS

INSTITUTIONAL LIFE SAFETY MORTISE DEADLOCK

SERIES 31SS55			BHMA CERTIFIED
			FINISH GROUPS
MARKS #	FUNCTION	ANSI #	32D
KEYED SINGLE CYLINDER, WITH DEADBOLT			
K	CYLINDER x KNOB	E06071	315.19
S	CLASSROOM	E06091	336.20

31SS55K: Function E06071;

Deadbolt by outside key.
Interior safety knob will retract
but not project deadbolt.

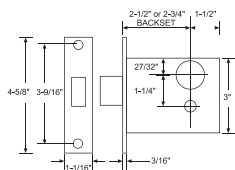
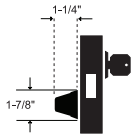

31SS55S: Function E06091;

Deadbolt by outside key.
Turnpiece will retract
but not project deadbolt.

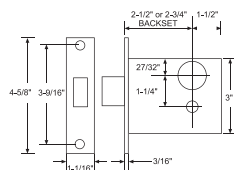
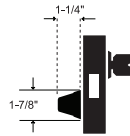

Performance Specifications:

Life Test: 1,500,000 cycles minimum.

ANSI Test: Meets or exceeds all operational and security tests of ANSI/BHMA Certified A156.5-2001 for series 31, Grade 1.

Fire Test: UL Listed, 3 Hour fire rated.

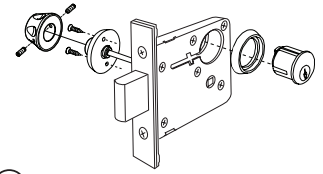

Trim Specifications:

Interior Trim: Solid stainless steel interior trim including finger indented safety knobs which recess into solid brass through-bolted roses.

Series 31 Deadlock Specifications:

Backset: 2-3/4"

Bolt throw: 1" stainless steel w/hardened roll pins

Case: Stamped Steel

Front: 1-1/16" x 4-5/8" adjustable bevel

Cylinder: Solid brass cylinder, 6-pin, "C" keyway, 2 keys.
Optional HI-SECURITY™ cylinders available.

Strike: #4035 Included

Antimicrobial Finish
Option Code: AM

★ Standard & HI-SECURITY™ IC Core Models:

Interchangeable Core models for 6 or 7 pin cores (not included).

Accepts: Marks, Marks HI-SECURITY™, Medeco®, KeyMark™, Falcon, Schlage® small format & Best®. **IC Core Tailpieces ARE Included.**



SERIES 180PD & 5PD HOSPITAL LifeSaver™ LOCKSETS

CYLINDRICAL & MORTISE PUSH/PULL PADDLESETS

Hospital Push/Pull Standard Features

- 1-3/4" door thickness, self adjusting for thicker doors
- Variable mounting positions
- Non-Handed
- Easily reversible configuration for push or pull styles

180PD Cylindrical Standard Features

- 2-3/4" backset std., 2-3/8", 3-3/4" & 5" optional
- 2-3/4" "T" strike; 4-7/8" ASA strike optional
- Government standard #161 door prep



ENGRAVING AVAILABLE

MARKS #	FUNCTION	ANSI #
N	PASSAGE	F75

FINISH: 32D Standard
Consult Factory for Additional Finishes
204.14

PUSH/PULLS ARE PACKED 6 PER CASE

180PD Cylindrical Paddleset

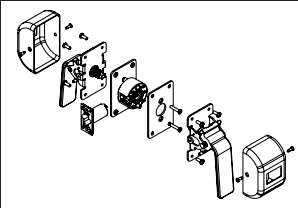
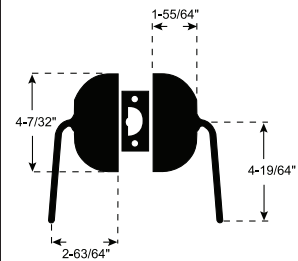

5PD, 55PD Mortise Standard Features

SERIES 5PD, 55PD • ANSI-A156.13 • Grade 1

- 5 Series Backset: 2-3/4"; 55 Series Backset: 2-1/2"
- Strike: #9035, 4-7/8" ASA curved lip strike



ENGRAVING AVAILABLE

MARKS #	FUNCTION	ANSI #
---------	----------	--------

FINISH: 32D Standard
Consult Factory for Additional Finishes

KEYED SINGLE CYLINDER, NO DEADBOLT

D	OFFICE VEST.	
DW	VESTIBULE	
E	OFFICE	F04
EW	STOREROOM	F07
J	CLASSROOM	F05
JM, JR	HOSPITAL	F06
GL	INSTITUTIONAL PRIVACY	F26
EL	ELECTRICALLY LOCKED	
EU	ELECTRICALLY UNLOCKED	

519.39

751.98

KEYED SINGLE CYLINDER, WITH DEADBOLT

A	ENTRANCE	F08, F10
B	ENTRANCE	F21
F	DORMITORY	F12
FS	DORMITORY	
FW	DORMITORY	F13
FD	APARTMENT	F20
H	HOTEL	F15
LH	SPECIAL PRIVACY	

530.37

546.15

KEYED DOUBLE CYLINDER, NO DEADBOLT

G	APARTMENT	F09
GC	INTRUDER LATCHBOLT	F32
GG	CLASSROOM SECURITY	
GR	CLASSROOM SECURITY w/ HOLDBACK	
WW	INSTITUTIONAL	F30

553.01

KEYED DOUBLE CYLINDER, WITH DEADBOLT

AC	ENTRANCE	F35
C	STOREROOM	F14
FC	INTRUDER DEADBOLT	F34
FA	DORMITORY	F11
FX	DORMITORY	F33

553.01

KEYLESS

N	PASSAGE	F01
L	BATHROOM	F02
LF	PRIVACY	F19
LJ	PRIVACY	F22
EX	EXIT	F31

447.35

530.37

486.46

PUSH/PULLS ARE PACKED 6 PER CASE

5PD Mortise Paddleset

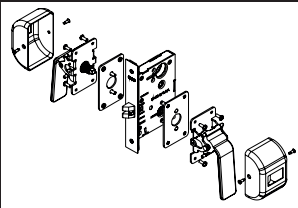
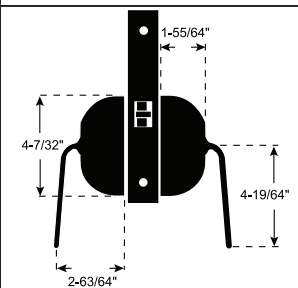

Hospital Push/Pull Paddlesets

How To Order

5PD or 180PD	F	/	32D	-	G3
1. Lockset Series	2. Marks Function	Slash	3. Finish	Dash	4. Options

MORTISE LOCK CYLINDERS

Cylinders

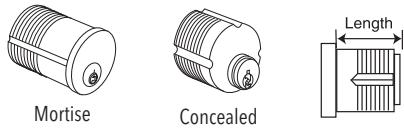

IC Core Cylinder Housings

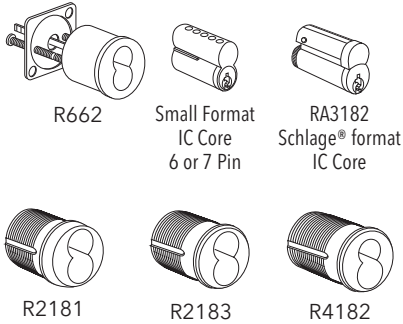

IC core pricing includes KA, KD or MK keying.

***Standard & HI-SECURITY™ IC Core Models:**
 Interchangeable Core models for 6 or 7 pin cores (not included).
Accepts: Marks, Marks HI-SECURITY™, Medeco®, KeyMark™, Falcon, Schlage® small format & Best®. **IC Core Tailpieces ARE Included.**

PART #	DESCRIPTION	PINS	LENGTH	FINISH GROUPS	
				3, 26D	5, 10, 10B, 15, 19, 26, 32D
2181	Mortise	6	2-7/8"	251.27	-
2182	Mortise	6	1-1/8"	63.34	70.59
2183	Mortise	6	1-1/4"	63.34	70.59
2193	Concealed	5	15/16"	84.47	-
2194	Concealed	6	1-1/8"	89.10	-
2196	Mortise	6	2-3/8"	350.64	-
2197	Mortise	6	1-3/4"	135.43	142.33
2198	Mortise	6	1-1/2"	108.77	112.25
662	Rim	6	-	63.64	70.59
R2181	Mortise SFIC Housing	6	1"	63.64	70.59
R2182	Mortise SFIC Housing	6	1-1/4"	57.86	61.33
R2183	Mortise SFIC Housing	6 or 7	1-3/8"	57.86	61.33
R2184	Mortise SFIC Cylinder Housing	6 or 7	1-3/4"	134.24	134.24
R3182	Schlage® type IC Core, 1 Bitted	6	-	134.24	-
R4182	Schlage® type IC Core Housing	6	1-1/2"	155.06	159.70
R662	Rim SFIC Housing	6 or 7	1-3/8"	67.12	70.59
R1182	6 Pin SFIC, Uncombined			50.91	-
R1183	7 Pin SFIC, Uncombined			50.91	-
RA1182	6 Pin SFIC, Combined			75.22	77.53
RA1183	7 Pin SFIC, Combined			75.22	77.53
RA3182	Schlage® type IC Core, Combined	6		159.70	-
RC1182	6 Pin SFIC, Construction Core			53.23	-
RC1187	Plastic SFIC Turn Knob			10.41	-
RC3182	Schlage® type Construction Core			134.24	-
RM1182	Marketing SFIC, Red			55.55	-

Cylinder Cams



PART #	DESCRIPTION	USE WITH OEM MORTISE LOCK	CODE	PRICE
2101	STRAIGHT CAM	MARKS	1	5.84
2101-A		ARROW/SARGENT	A1	5.84
2101-C		CORBIN RUSSWIN	C1	5.84
2101-S		SCHLAGE NON-MODULAR	S1	5.84
2102	CLOVERLEAF CAM	MARKS	2	5.84
2102-A		ARROW/SARGENT	A2	5.84
2102-C		CORBIN RUSSWIN	C2	5.84
2102-S		SCHLAGE NON-MODULAR	S2	5.84

PART #	DESCRIPTION	USE WITH OEM MORTISE LOCK	CODE	PRICE
2104	ADAMS-RITE CAM	MARKS	4	5.84
2105	"J" FUNCTION CAM	MARKS	5	5.84
2105-A		ARROW/SARGENT	A5	5.84
2105-C		CORBIN RUSSWIN	C5	5.84
2105-S		SCHLAGE NON-MODULAR	S5	5.84
2107-CL	"J-CL" FUNCTION CAM	MARKS	7	5.84
2106	"G" CAM Exterior only	MARKS	6	5.84
2106-A		ARROW/SARGENT	A6	5.84
2106-C		CORBIN RUSSWIN	C6	5.84
2106-S		SCHLAGE NON-MODULAR	S6	5.84

Mortise Cylinders, Parts, Cams

How To Order Example for Mortise Lock Cylinders

2182	/	32D	-	1C
1. Cylinder	Slash	2. Finish	Dash	3. Options

See List Of
 ___ Cylinders
 ___ Available

FINISH
 (Pg. 8)

___ 3 ___ 5 ___ 10 ___ 10B
 ___ 15 ___ 26 ___ 26D ___ 32D

___ Special **Specify**
 ___ Keying
 ___ Door Thickness

Cam and keying information must be included in the option section.

KEYS & KEYING

Keys

Can Stamp A Maximum Of 6 Characters On Key.

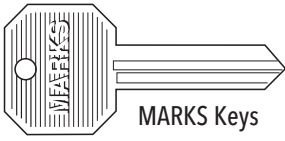

MARKS Keys

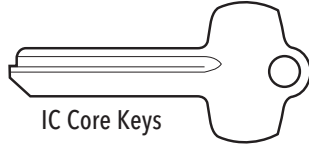

IC Core Keys

STANDARD KEYWAYS	PIN LENGTH ACCEPTS	SHOULDER INCREMENTS	PIN TO PIN TO 1st PIN	PLUG DISTANCE	DIAMETER
MARKS "A"	Arrow Kwikset Segal 9	.015"	.264"	.156"	.504"
MARKS "C"	Schlage "C"	.015"	.231"	.156"	.504"

PART #	DESCRIPTION	PRICE	
		EACH	CUT
2164A	MARKS "A" 5 PIN BRASS	5.00	6.00
2164C	MARKS "C" 5 PIN BRASS, NICKEL PLATED	5.00	6.00
2184A	MARKS "A" 6 PIN NICKEL SILVER	6.00	7.00
2184C	MARKS "C" 6 PIN NICKEL SILVER	6.00	7.00
R1164	IC CORE 6 OR 7 PIN (SMALL FORMAT)	6.00	7.00
R3164	SCHLAGE® IC CORE CONTROL KEY	6.00	7.00

BEST® A thru M keyway. Please specify.
IC Core pricing includes KA, KD or MK Keying.

PART #	DESCRIPTION	PRICE	
		REGULAR	IC CORE
KA	KEYED ALIKE	NC	NC
KD	KEYED DIFFERENT	NC	NC
MK	MASTER KEYED	15.00	17.00
CMK	CONSTRUCTION MASTER KEYED (Includes GMK or MK)	22.00	-
GMK	GRAND MASTER KEYED	15.00	17.00
GGMK	GREAT GRAND MASTER KEYED	15.00	17.00
GGGMK	GREAT GREAT GRAND MASTER KEYED	15.00	-

STAMPING	PRICE
LETTERS/NUMBERS ON KEY - PER KEY	6.00
US PROPERTY - "DO NOT DUPLICATE" - PER KEY	6.00
VISUAL KEY CONTROL (VKC)	12.00
CONCEAL KEY CONTROL	12.00
EXTRA CUT KEYS WITH LOCKSET	SEE KEYS ABOVE
KEY BITTING CODE LIST	N/C

IC CORE PRICING INCLUDES KA, KD OR MK KEYING

Construction Master Keying:

The construction master key (CMK) is to be used temporarily while the building is under construction. When construction is completed, the end user defeats the CMK's operation by turning the change key in each cylinder, rather than replace or re-keying the cylinder.

Marks USA uses a program which is called the "lost ball" program. When construction key system is set up, three small ball bearings (construction balls) are placed between the bottom pin and master pin, normally in the last chamber as a "temporary master pin". The construction key is usually the same cut as the top master key with the exception of the sixth cut which is two increments higher. The construction master key will work in any cylinder until cylinder is "defeated" by making one full rotation in the cylinder with the change key. The cylinder plug requires a small diameter "pocket" drilled on one side of one pin chamber so when rotating the cylinder with the change key the pocket will capture the construction balls. The construction pocket in the plug is smaller than a pin chamber. This prevents any top pins or master pins from entering as the plug rotates. Once the cylinder is defeated, there is no way for the cylinder to be construction keyed again without disassembling it.

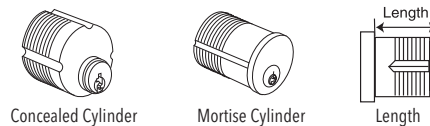
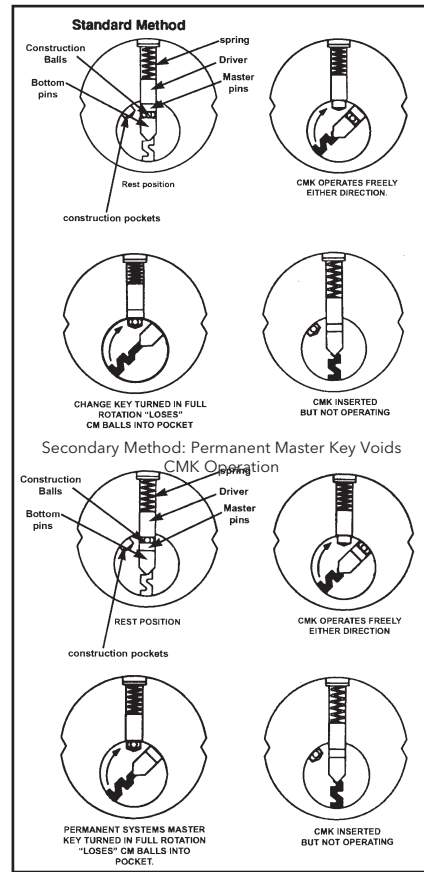

Concealed Cylinder

Mortise Cylinder

Length

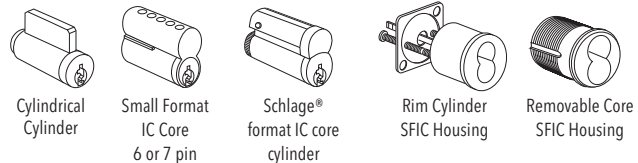

Cylindrical Cylinder

Small Format IC Core 6 or 7 pin

Schlage® format IC core cylinder

Rim Cylinder SFIC Housing

Removable Core SFIC Housing

★ Standard & HI-SECURITY™ IC Core Models:

Interchangeable Core models for 6 or 7 pin cores (not included).

Accepts: Marks, Marks HI-SECURITY™, Medeco®, KeyMark™, Falcon, Schlage® small format & Best®. **IC Core Tailpieces ARE Included.**





HI-SECURITY™ CYLINDERS: NON-UL





HI-SECURITY™ MORTISE CYLINDERS					
	NON-UL "0" Bitted x 2 Keys; "0" Bitted "NO KEYS" - Deduct \$7		FINISH GROUPS		
	PART #	DESCRIPTION	3, 26D	4, 5, 10, 10B, 15, 26, 32D	
	BXXX-D001A0N2	1-1/8" Mortise Cylinder	85.34	92.58	
	CXXX-D001A0N2	1-1/4" Mortise Cylinder	92.58	100.68	
	DXXX-D001A0N2	1-3/8" Mortise Cylinder	107.62	113.41	
	NON-UL KD x 2 Keys				
	BXXX-D001A1N2	1-1/8" Mortise Cylinder	93.74	102.99	
	CXXX-D001A1N2	1-1/4" Mortise Cylinder	102.99	107.62	
	DXXX-D001A1N2	1-3/8" Mortise Cylinder	116.88	122.66	
	HI-SECURITY™ CYLINDERS ARE PACKED 24 PER CASE				

HI-SECURITY™ MORTISE/RIM COMBO CYLINDERS					
	NON-UL "0" Bitted x 2 Keys; "0" Bitted "NO KEYS" - Deduct \$7		FINISH GROUPS		
	PART #	DESCRIPTION	3, 26D	4, 5, 10, 10B, 15, 26, 32D	
	EXXX-D001A0N2	1" Combo Cylinder	77.53	83.32	
	FXXX-D001A0N2	1-1/8" Combo Cylinder	92.58	100.67	
	NON-UL KD x 2 Keys				
	EXXX-D001A1N2	1" Combo Cylinder	86.79	92.58	
	FXXX-D001A1N2	1-1/8" Combo Cylinder	102.99	107.62	
	HI-SECURITY™ CYLINDERS ARE PACKED 24 PER CASE				

HI-SECURITY™ KIK CYLINDERS					
	NON-UL "0" Bitted x 2 Keys; "0" Bitted "NO KEYS" - Deduct \$6		FINISH GROUPS		
	PART #	DESCRIPTION	26D		
	G26D-D001X0N2	Key-In-Knob Cylinder	70.59		
	NON-UL KD x 2 Keys				
	G26D-D001X1N2	Key-In-Knob Cylinder	77.53		
	HI-SECURITY™ CYLINDERS ARE PACKED 24 PER CASE				

HI-SECURITY™ MARKS SFIC CORES					
	NON-UL "0" Bitted x 2 Keys x 1 Control Key; "0" Bitted "NO KEYS" - Deduct \$6		FINISH GROUPS		
	PART #	DESCRIPTION	26D		
	H26D-D001X0N2	6 Pin SFIC	77.53		
	J26D-D001X0N2	7 Pin SFIC	81.01		
	NON-UL KD x 2 Keys x 1 Control Key				
	H26D-D001X1N2	6 Pin SFIC	90.26		
	J26D-D001X1N2	7 Pin SFIC	93.74		
HI-SECURITY™ CYLINDERS ARE PACKED 24 PER CASE					

HI-SECURITY™ Schlage® LARGE FORMAT IC CORES					
	NON-UL "0" Bitted x 2 Keys x 1 Control Key; "0" Bitted "NO KEYS" - Deduct \$6		FINISH GROUPS		
	PART #	DESCRIPTION	26D		
	K26D-D001X0N2	6 Pin Schlage® IC Core	98.37		
	NON-UL KD x 2 Keys x 1 Control Key				
	K26D-D001X1N2	6 Pin Schlage® IC Core	109.93		
	HI-SECURITY™ CYLINDERS ARE PACKED 24 PER CASE				

HI-SECURITY™ Medeco® LARGE FORMAT IC CORES					
	NON-UL "0" Bitted x 2 Keys x 1 Control Key; "0" Bitted "NO KEYS" - Deduct \$6		FINISH GROUPS		
	PART #	DESCRIPTION	26D		
	P26D-D001X0N2	6 Pin Medeco® IC Core	120.35		
	NON-UL KD x 2 Keys x 1 Control Key				
	P26D-D001X1N2	6 Pin Medeco® IC Core	133.08		
HI-SECURITY™ CYLINDERS ARE PACKED 24 PER CASE					

HI-SECURITY™ SPECIAL APPLICATION CYLINDERS					
	KA Pair w/ 2 Keys, NON-UL, Straight Cam			FINISH GROUPS	
	PART #	DESCRIPTION	3, 26D	5, 15	
	2122XXXHSM	15/16" Mortise Cylinders	120.37	133.08	
HI-SECURITY™ SPECIAL APPLICATION CYLINDERS ARE PACKED 24 PER CASE					

HI-SECURITY™
Cylinders

HI-SECURITY™ CYLINDERS



Security-Mate™ & SPECIAL APPLICATION CYLINDERS

Security-Mate™ MORTISE CYLINDERS				
	"0" Bitted "NO KEYS"		FINISH GROUPS	
	PART #	DESCRIPTION	3, 26D	4, 5, 10, 10B, 15, 26, 32D
	BXXX-DXXXA0N0	1-1/8" Mortise Cylinder	67.12	92.58
	CXXX-DXXXA0N0	1-1/4" Mortise Cylinder	72.91	100.68
	DXXX-DXXXA0N0	1-3/8" Mortise Cylinder	85.64	113.41
	LXXX-DXXXA0N0	1-1/2" Mortise Cylinder	100.68	126.14
	MXXX-DXXXA0N0	1-3/4" Mortise Cylinder	113.41	143.49

Security-Mate™ CYLINDERS ARE PACKED 24 PER CASE

Security-Mate™ MORTISE/RIM COMBO CYLINDERS				
	"0" Bitted "NO KEYS"		FINISH GROUPS	
	PART #	DESCRIPTION	3, 26D	4, 5, 10, 10B, 15, 26, 32D
	EXXX-DXXXA0N0	1" Combo Cylinder	55.98	63.64
	FXXX-DXXXA0N0	1-1/8" Combo Cylinder	72.91	77.53

Security-Mate™ CYLINDERS ARE PACKED 24 PER CASE

Security-Mate™ KIK CYLINDERS			
	"0" Bitted "NO KEYS"		FINISH GROUPS
	PART #	DESCRIPTION	26D
	G26D-DXXXX0N0	Key-In-Knob Cylinder	52.07

Security-Mate™ CYLINDERS ARE PACKED 24 PER CASE

Security-Mate™ MARKS IC CORES			
	"0" Bitted "NO KEYS"		FINISH GROUPS
	PART #	DESCRIPTION	26D
	H26D-DXXXX0N0	6 Pin IC Core	57.86
	J26D-DXXXX0N0	7 Pin IC Core	63.64

Security-Mate™ CYLINDERS ARE PACKED 24 PER CASE

Security-Mate® Schlage™ LARGE FORMAT IC CORES			
	"0" Bitted "NO KEYS"		FINISH GROUPS
	PART #	DESCRIPTION	26D
	K26D-DXXXX0N0	6 Pin Schlage® IC Core	79.85

Security-Mate™ CYLINDERS ARE PACKED 24 PER CASE

Security-Mate® Medeco™ LARGE FORMAT IC CORES			
	"0" Bitted "NO KEYS"		FINISH GROUPS
	PART #	DESCRIPTION	26D
	P26D-DXXXX0N0	6 Pin Medeco® IC Core	102.99

Security-Mate™ CYLINDERS ARE PACKED 24 PER CASE

HI-SECURITY™
Cylinders

HI-SECURITY™ CYLINDERS

HOW TO ORDER HI-SECURITY™ CYLINDERS AND KEYS

How To Order Example for HI-SECURITY™ Cylinders								
D	3	-	D	001	A	3	U	2
1. Cylinder Type	2. Finish	Dash	3. Keyway	4. Security Code	5. Cam Tail	6. Keying	7. NON-UL / UL437	8. # of Keys

CYLINDER TYPE	FINISH	KEYWAY	SECURITY CODE	CAM TAIL MORTISE	KEYING	UL or NON-UL	KEYING
___ B = 1-1/8" Mortise	___ 3	___ D = HS	___ 001 = MARKS	___ A = 2101	___ 0 = "0" Bitted	___ U = UL 437	___ 0 = "0" Bitted
___ C = 1-1/4" Mortise	___ 4			___ B = 2102	___ 1 = KD		___ 1 = 1 Key
___ D = 1-3/8" Mortise	___ 5			___ D = 2104	___ 2 = KA	___ N = NON UL	___ 2 = 2 Keys
___ L = 1-1/2" Mortise	___ 10			___ E = 2105	___ 3 = CMK		___ 3 = 3 Keys
___ M = 1-3/4" Mortise	___ 15			___ F = 2106	___ 4 = GMK		Up to 9, Then as separate line item
___ E = 1" Combo	___ 10B			KIK	___ 5 = MK		
___ F = 1-1/8" Combo	___ 15			___ A = Standard Tail	___ 6 = GGMK		
___ G = KIK Cylinder	___ 26			___ B = Classroom Tail			
___ H = IC Core Marks 6 Pin	___ 26D			___ C = i-Que Electronic			
___ J = IC Core Marks 7 Pin	___ 32			IC CORE			
___ K = IC Core Schlage® Large Format	___ 32D			___ A = 6 Pin IC			
___ P = IC Core Medeco® Large Format				___ B = 7 Pin IC			

How To Order Example for HI-SECURITY™ Keys				
HS	6	D	001	C
1. Key Type	2. Pins	3. Keyway	4. Security Code	5. Special Key Type

KEY TYPE	PINS	KEYWAY	SECURITY CODE	SPECIAL KEY TYPE
___ HS = HI-SECURITY™	___ 5 Pin	___ D = HS	___ 001 = Marks	___ C = Control Key
___ RS = IC Core	___ 6 Pin			
	<input type="checkbox"/> 7 Pin			

HI-SECURITY™
Cylinders



HI-SECURITY™ CYLINDERS









KEYS, CAMS & TAILPIECES

KEYS			
	PART #	DESCRIPTION	PRICE
	HS5D001	5 Pin Key Blank	11.00
	HS6D001	6 Pin Key Blank	11.00
	RS6D001	6 Pin SFIC Key Blank	11.00
	RS7D001	7 Pin SFIC Key Blank	11.00
	Schlage® IC CORE CONTROL KEY		
	HSR3184	Control Key Blank	11.00
CUT KEYS			
	Conventional Cylinder		15.00
	SFIC Core Cylinder		15.00

KEYING CHARGES			
PART #	DESCRIPTION	REG PRICE	IC CORE
KA, KD	Keyed Alike, Keyed Different	NC	NC
MK	Master Keyed	15.00	17.00
GMK	Grand Master Keyed	15.00	17.00
GGMK	Great Grand Master Keyed	15.00	17.00
VKC	Visual Key Control	12.00	

MORTISE CYLINDER CAMS			
	PART #	DESCRIPTION	PRICE
	2101HS	Straight Cam	7.59
	2102HS	Clover Cam	7.59
	2104HS	Adams Rite Cam	7.59
	2105HS	J - Cam	7.59
	2106HS	G - Cam	7.59
	2107-CLHS	Straight Cam	7.59

Schlage® LARGE FORMAT IC CORE HOUSING CAMS			
	PART #	DESCRIPTION	PRICE
	2101 HSPM	Straight Cam	7.59
	2102 HSPM	Clover Cam	7.59
	2104 HSPM	Adams Rite Cam	7.59
	2105 HSPM	J - Cam	7.59
	2106 HSPM	G - Cam	7.59
	2107-CL HSPM	Straight Cam	7.59

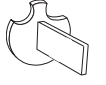
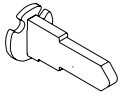
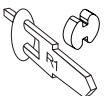
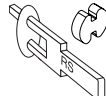
CYLINDRICAL TAIL PIECES			
	PART #	FUNCTIONS	PRICE
	F1903-C	AB, DW, F	6.42
	F1903S-C	S, DA, DB, DC, SB, T	6.42
IC CORE TAILPIECES			
	HR1984-HS	AB, B, DA (ext.), DW, F, FEU, FEL	6.42
	HR1984S-HS	S, DA (int.), DB, DC, SB, T	6.42

HI-SECURITY™
Cylinders

HI-SECURITY™ CYLINDERS



PARTS LIST

PARTS LIST			
PART #	DESCRIPTION	PRICE	PACKED
P2031	Finger Pins #1 (Silver)	30.35	25 per pack
P2032	Finger Pins #2 (Copper)	30.35	25 per pack
P2033	Finger Pins #3 (Black)	30.35	25 per pack
P2034	Finger Pins #4 (Gold)	30.35	25 per pack
P2035	Sidebar - Schlage® IC	30.35	25 per pack
P2036	Sidebar - Combo, KIK, Mortise	30.35	25 per pack
P2051	Sidebar - Best® IC	30.35	25 per pack
P2037	Sidebar Springs	30.35	50 per pack
P2044	Mortise Cam Screws	17.51	12 per pack
P2045	IC Mortise Cam Screws - SCHLAGE® ONLY	17.51	12 per pack
P2041	Schlage® IC Cap Pin	30.35	12 per pack
P2042	Schlage® IC Cap Pin Spring	30.35	12 per pack
P2046	Schlage® IC Screw Cap	30.35	6 per pack
P2048	KIK Screw Cap	30.35	6 per pack
P2043	Best® IC Clip	30.35	12 per pack
P2039	Top Hex Screws (HI-SECURITY™ Mortise)	17.51	12 per pack
P2029	Top Hex Screws (HI-SECURITY™ Best® IC)	17.51	12 per pack
P2047	HI-SECURITY™ Registration Card	46.29	10 cards
R2984	7 Pin IC Tailpiece (AB, DW, F)	7.00	-
R2984S	7 Pin IC Tailpiece (S, DA, DB, DC, SB, T, TS)	7.00	-
R1981	Spacer	7.00	-
2049	Plug Holder	46.29	-
HSICT	Shear Tool	263.23	-
HSC387	HPC Card C387	58.37	-

HI-SECURITY™
Cylinders

SERIES M9900 EXIT DEVICE

RIM MOUNT



- EXTRUSION HEAVY GAGE 32D FINISH
- LIFETIME MECHANICAL WARRANTY
- PANIC PROTECTOR™ END CAP
- EASY INSTALLATION, ECONOMICAL



MARKS #	FUNCTION	PRICE	
		32D	10B (19)
M9900	Rim Panic	476.11	553.77
M9900F	Fire Rated Rim Panic	536.72	614.97
M9900H	Hurrican Rated Rim Panic	536.72	614.97
M9900 - 48	Rim Panic - 48"	524.60	602.85
M9900F - 48	Fire Rated Rim Panic - 48"	587.42	665.67
M9900H-48	Hurrican Rated Rim Panic - 48"	587.42	665.67

INFORMATION	
M9900	33" Length for 38" Door
M9900-48"	42" Length for 48" Door

SPECIFICATIONS
• Doors: 1 3/4" thick standard
• End Cover: Stainless steel beveled "Panic Protector" design
• Strike: Roller strike
• Rail Assembly: Heavy Gauge Stainless Steel
• Dead latch Bolt: Stainless Steel 3/4" throw.
• Dead latch Bolt: Stainless Steel 5/8".
• Dogging feature: Allen Key (M9900)
• UL listed: For "Panic Hardware" and Fire Rated Model 3 hour fire doors up to 38" x 86".
• ANSI: ANSI 156.3 (2001), requirements for Grade 1
• 3 Hour Fire Rating

SERIES M9900 VR EXIT DEVICE

SURFACE VERTICAL ROD

Exit Devices

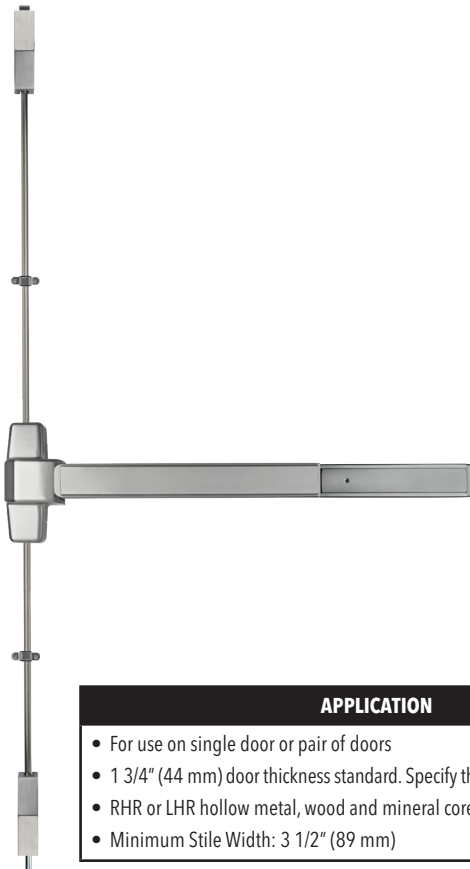





MARKS #	FUNCTION	PRICE	
		32D	10B (19)
M9900 VR	Rim Panic Vertical Rod	632.61	704.24
M9900F VR	Fire Rated Rim Panic Vertical Rod	695.43	773.67
M9900 - 48 VR	Rim Panic Vertical Rod - 48"	663.17	741.71
M9900F - 48 VR	Fire Rated Rim Panic Vertical Rod - 48"	726.29	800.13

SPECIFICATIONS
• Device Head Cover: Zinc alloy or stainless steel
• Chassis: Steel, plated
• Mechanism Housing: Extruded aluminum
• Push Bar Base: Extruded aluminum
• Touch Plate: Stainless Steel
• End Cap: Stainless Steel
• Top Latch: Stainless Steel 37/64" (14.8mm)
• Top Strike: Included
• Bottom Latch: Stainless Steel 37/64" (14.8mm)
• Bottom Strike: Included
• Latch Case Covers: Steel, stainless steel or brass
• Vertical Rods: Aluminum tube
• Hand: Non-handed
• Mounting: Machine screws standard. Sex bolts optional. Order "SNB" for wood or unreinforced metal doors
• Dogging: Allen-type key furnished
• Outside Trim: Order separately
• Standard Height: 7' doors
• UL listed: ANSI/BHMA Grade 1 Panic Exit Hardware
• 3-Hour Fire Rated

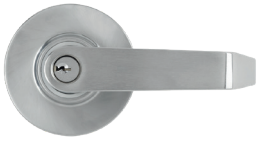
APPLICATION
• For use on single door or pair of doors
• 1 3/4" (44 mm) door thickness standard. Specify thickness other than 1 3/4"
• RHR or LHR hollow metal, wood and mineral core doors
• Minimum Stile Width: 3 1/2" (89 mm)

SERIES M9900 EXTERIOR TRIM

M411 	Lever/Rose  M195F	Rim Panic Vandal Pull MVP/32D 
MES600A 	Cylindrical Dogging Kit - 32D  M9901	Rim Panic Vandal Pull w/ cylinder hole MVPCC/32D (cylinder not included) 

ENTRY LEVER TRIM
<ul style="list-style-type: none"> • Standard Marks "C" Keyway KNK cylinder for panic device. • Cylinder locks or unlocks lever, rigid when locked; when unlocked retracts latch bolt. • Marks 26D Finish / Standard 1-3/4" Door Thickness • IC Prep Code G1, Less Cylinder G3

ESCUTCHEON LEVER DESIGN
<ul style="list-style-type: none"> • Thru bolt design • Non Handed design. Easily field reversible. • Marks 32D Finish / Standard 1-3/4" Door Thickness • Standard Marks "C" Keyway 1-1/4" Mortise cylinder with special cam • IC Prep Code G1 • Less Cylinder G3

MARKS #	DESCRIPTION	PRICE	
		26D	10B (19)
M411	Finger Pill - no cylinder	26.62	30.08
MESC600A	Lever / Escutcheon Trim Entry	152.75	202.51
MESC600F	Lever / Escutcheon Trim Storeroom	152.75	202.51
MESC600N	Lever / Escutcheon Trim Passage	131.92	184.00
MESC600DT	Lever / Escutcheon Trim Dummy Trim	131.92	184.00
MESC350FEU/EL	Lever / Escutcheon Trim Entry	849.24	-
MESC350A	Lever / Escutcheon Trim Entry	152.75	-
MESC350F	Lever / Escutcheon Trim Storeroom	152.75	-
M9901	Panic Device Dogging Kit	94.89	113.41
MVR8	Vertical Rod 8 ft - Code 8	47.45	53.71
MVR10	Vertical Rod 10 ft - Code 10	76.38	84.30
MVRB	Vertical Rod - Bottom Rod	32.40	-
MVP/32D	Rim Panic Vandal Pull	437.75	-
MVPCC/32D	Rim Panic Vandal Pull w/ cylinder hole	496.12	-

ELECTRIFIED TRIM - M9900
<ul style="list-style-type: none"> • Available Fail Safe (EL) Fail Secure (EU) • Standard Voltage 24VDC 150mA • Optional 12V 250mA • 26D Finish

MARKS #	DESCRIPTION	PRICE
		26D
MESC600FEL	Fail Safe Trim 24VDC	824.50
MESC600FEU	Fail Secure Trim 24VDC	824.50
OPTION H2	12VDC Option	NC

*Sub other lever on MESC - 24

Exit Devices

SERIES M8800 EXIT DEVICE

THIN LINE TM RIM MOUNT



*Use MESC350 for Trim

MARKS #	FUNCTION	PRICE	
		32D	10B(19)
M8800	Rim Panic	513.59	644.95

Specifications	
Specification:	Conforms to ANSI BHMA A156.3 Grade 1 Exit Device Requirement Standard ANSI/UL305 Standard for Safety for Panic Hardware 2013 California Building Code Sec. 11B-309.4 (Please specify when ordering non standard size doors)
For Doors:	Thickness: Standard 1 3/4", may fit with door thickness up to 2" Width: Standard 36", may fit door width 30"
Mounting:	Furnished Standard with Wood and Machine Screws
Head Cover:	Zinc Alloy
Chassis:	Aluminum
Rail Assembly:	Heavy Gauge extruded aluminum with stainless steel on top of touch bar
End Cap:	Zinc Alloy
Hand:	Non-handed
Latch Bolt:	Stainless Steel, 3/4" (18mm) throw
Strike:	Roller Strike (Stainless Steel)
Dogging:	Allen Key (equipped on panic rate devices only)
Dimension:	Touch bar height from finished floor: 41" (1041mm) from center of touch bar Touch Bar Projection: Neutral: 3 5/16" (84mm) Depressed: 2 19/32" (66mm) Head Cover: LxWxH: 206mm x 76mm x 71mm Device Length: 34 5/8" (88cm) for 36" door width

SERIES M195 EXIT DEVICE TRIM

Specifications	
Levers:	Solid cast Zamac, with 1/2" return (except 495)
Roses:	Thru-bolted, 3-7/16" spring loaded Roses
Door Thickness:	1-5/8" - 1-7/8"
Clutch:	Standard
Chassis:	Steel
Cylinder:	MARKS "C" keyway, 6 pin w/ 2 keys SFIC model - Core not included
<i>Lifetime Mechanical Warranty</i>	

MARKS #	Trim	26D	19
M195S/295/495	Entry	189.78	239.54
M195RS/295/495	Entry for SFIC	189.78	239.54
M195F/295/495	Storeroom	189.78	239.54
M195RF/295/495	Storeroom for SFIC	189.78	239.54
M195N/295/495	Passage	175.89	214.08
M195DT/295/495	Dummy	175.89	214.08

OPTIONS	CODE	PRICE- 195	295
Yale/Accentra Conventional	F7	15.00	-
Sargent conventional cylinder	F8	15.00	-
Corbin Russwin conventional cylinder	F9	15.00	-
Corbin Russwin 6 pin IC core	F12	22.00	-
Corbin Russwin 7 pin IC core	F13	22.00	-
Yale/Accentra 6 pin IC core	F14	15.00	-
Yale/Accentra 7 pin IC core	F15	15.00	-
Schlage 6 pin IC core	F19	15.00	-
Sargent IC core	F20	15.00	-
Medeco IC core large format	F21	15.00	15.00
Less Cylinder	G3	-10.00	-10.00

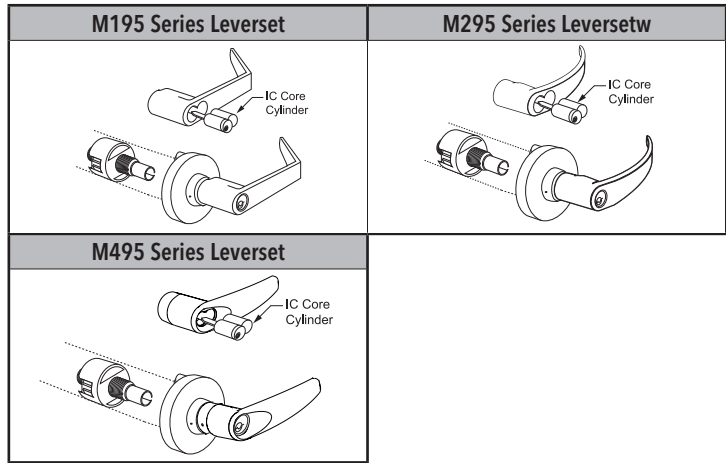

★ **Standard & HI-SECURITY™ SFIC Models:** Interchangeable Core models for 6 or 7 pin cores (not included). **Accepts:** Marks, Marks HI-SECURITY™, Medeco®, KeyMark™, Falcon, Schlage® small format & Best®. **SFIC Tailpieces ARE INCLUDED.**

SEE PAGE 67
FOR TAILPIECES

Exit Devices

SERIES M99 NIGHT LATCH TRIM

SPECIFICATIONS	
• Fixed pull for Marks USA rim panic devices.	
• US32D stainless steel material	
• US 32D finish	
• Supplied with cylinder collar and mounting cylinder cup.	
*Available in Marks USA "C" conventional rim cylinder and Marks USA "Best size" SFIC rim cylinder (less core)	
• Available in Dummy trim, less cylinder hole	

MARKS #	Night Latch Trim	32D
M99F/32D	With Marks C Rim Cylinder	225.66
M99F/32D-G1	With SFIC Rim Cylinder Housing	225.66
M99F/32D-G3	With Cylinder hole - Less Cylinder	208.29
M99DO/32D	Dummy Trim	196.72

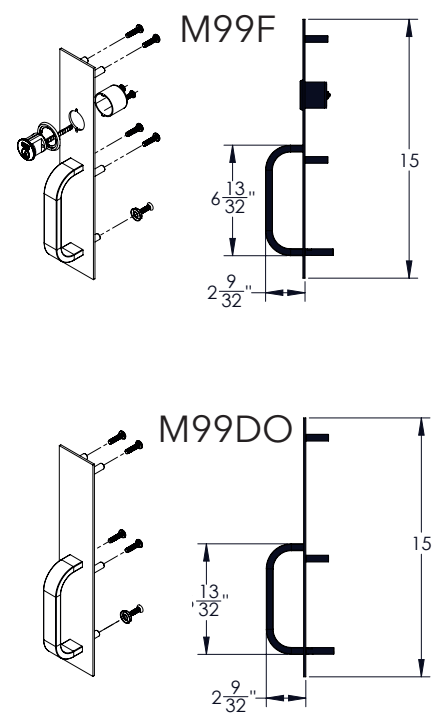

ELECTRIC LATCH RETRACTION

WITH SIMULTANEOUS DOGGING



Rim Mount & Mortise

DEVICE SPECIFICATIONS	
ER	Electric Latch Retraction with simultaneous dogging
For:	M9900
Operation:	Momentary or maintained latch bolt and push pad retraction. Automatic re-triggering of latch retraction
Voltage:	24VDC @ 450 mA activation, 180 mA continuous
EMC	2-station sequencer required for automatic doors only.
Monitoring Available	Latch status and REX output available

MARKS #	DESCRIPTION	32D	10B
M9900ER	Electric Latch Retraction	1347.83	1406.20
M9900ER-48	Electric Latch Retraction 48"	1398.57	1515.30
M9900 VR ER	Fire Rated Rim Panic Vertical Rod 48"	1540.73	1639.93

EXIT ALARM

EMERGENCY EXIT ONLY
DOOR ALARM WILL SOUND

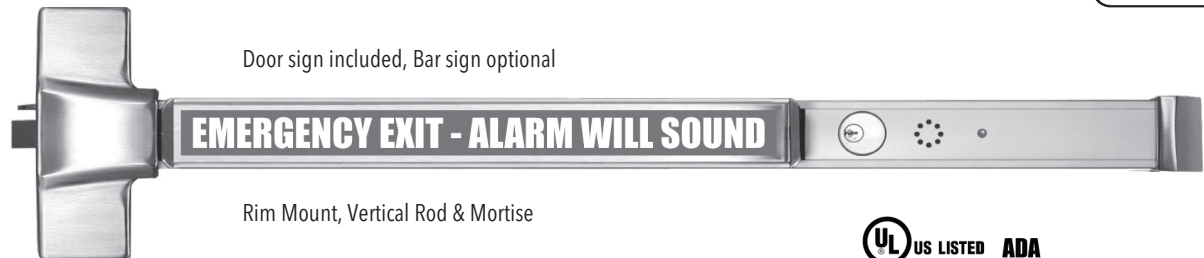

Door sign included, Bar sign optional

Rim Mount, Vertical Rod & Mortise

DEVICE SPECIFICATIONS	
EA	Exit Alarm, 9V battery powered
EB	Exit Alarm, 12-24V AC/DC input, 9V battery backup
For:	M9900
	<ul style="list-style-type: none"> 100 dB alarm; visual and audible On/Off status: Armed - green LED blinks every 4 seconds, Alarm mode - red LED, Bypass - no LED Remote status output 15 or 60 second arming delay 2 modes: Continuous alarm with manual key reset; Automatic re-arm 2 minutes after door closes with any manual key reset before 2 minutes.
Options:	<ul style="list-style-type: none"> Push pad sign 6, 10 & 20 minutes alarm; 1 or 5 second re-arm delay Remote access control, arm, disarm inputs REX and latch status outputs

MARKS #	DESCRIPTION	PRICE
M9900EA	Exit Alarm 9VDC	1492.20
M9900EB	Exit Alarm 9VDC w 12/24 AC/DC Input	1587.02

Exit Devices

ELECTRIC DOGGING



Rim Mount, Vertical Rod & Mortise

DEVICE SPECIFICATIONS
<p>DG Electric Dogging (failsecure) M9900, When energized by optional built-in or remote switch manual, depressing the pushpad, causes the pushpad and latch to remain retracted (unlocked) providing push-pull door operation. When de-energized or signaled by a fire alarm, the pushpad and latch are released.</p> <p>Voltage: 170/100 mA @ 12/24VDC</p> <p>Monitoring Available: Latch status and REX output available</p>

MARKS # (Options for Parice)	DESCRIPTION	PRICE
M9900DG	Electric Dogging, Fail Secure	1587.00
P6-Rex	Request to Exit	36.19

DELAYED EGRESS

Exit Devices

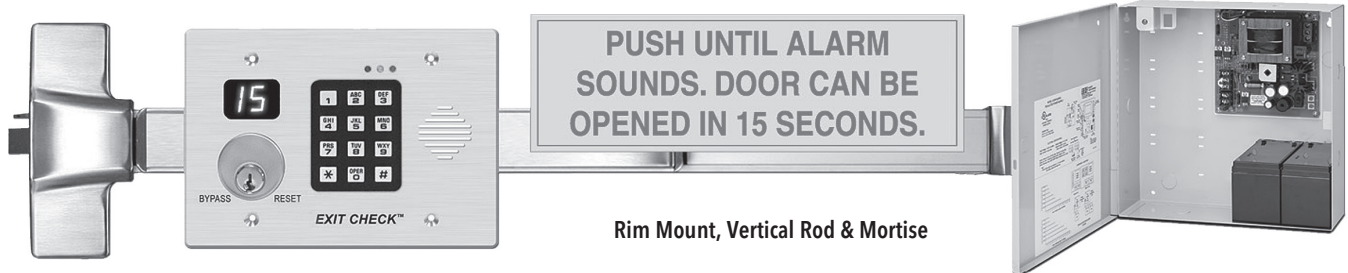

Rim Mount, Vertical Rod & Mortise

DEVICE SPECIFICATIONS
<p>DE Wall mount delayed egress controller with keypad and electrified exit device, M9900, M9900VR</p> <p>Example: M9900F/32D-DE</p> <p>DEK Keypad controller with redundant key switch capable of all keypad control features</p> <p>602RF 1 Amp power supply</p> <ul style="list-style-type: none"> User PIN codes may be assigned to 1, 2 or all control functions. Reset, sustained bypass and momentary bypass (RES) Audible alarm voice release time, warning or safety message Visual display countdown, locked/unlocked, egress executed 15 or 30 second exit delay, 1 or 2 second nuisance delay 2 minutes <p>Monitoring Available: Latch status available</p>

MARKS #	DESCRIPTION	PRICE
M9900DE	Delayed Egress	3870.00
M9900KDE	Delayed Egress w Keyswitch	4142.80
M9900VRDE	Delayed Egress	4045.80
M9900VRKDE	Delayed Egress w Keyswitch	4299.29

M99LD SERIES LOCKDOWN EXIT DEVICE



Clear View Visual Lockdown Indicator on Inside Door



Field-Reversible Suits Every Application

SPECIFICATIONS:

- **Device Head Cover:** Zinc alloy
- **Chassis:** Steel, plated
- **Mechanism Housing:** Extruded aluminum
- **Push Bar Base:** Extruded aluminum
- **Touch Plate:** Solid
- **Activation:** Choice of Key or Thumbturn

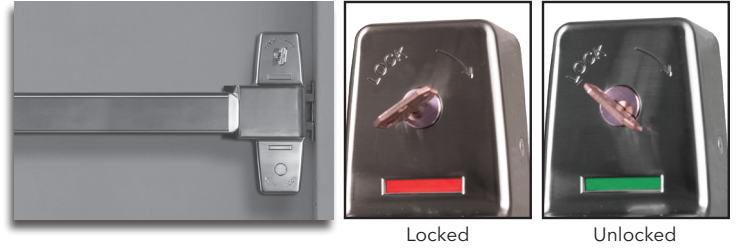

MARKS #	Function	Price	
		32D	19
M99LD92	With Marks C Rim Cylinder	1959.08	2350.89
M99LD92-48	With SFIC Rim Cylinder Housing	2007.57	2409.08
M99LD86	With Cylinder hole - Less Cylinder	1959.08	2350.89
M99LD86-48	Dummy Trim	2007.57	2409.08

Options(Prep)	Code	Price
Yale/Accentra Conventional	F7	15.00
Sargent Conventional Cylinder	F8	15.00
Corbin Russwin 6 Pin IC Core	F9	15.00
Corbin Russwin 7 Pin IC Core	F12	22.00
Corbin Russwin 6 Pin IC Core	F13	22.00
Yale/Accentra 6 Pin IC Core	F14	15.00
Yale/Accentra 7 Pin IC Core	F15	15.00
Schlage 6 Pin IC Core	F19	15.00
Sargent IC Core	F20	15.00
Medeco IC Core Large Format	F21	15.00
Small Format IC Core	G1	0.00
Less Cylinder	G3	-10.00
T Turn	G12	0.00

Exit Devices

M9900 LITE

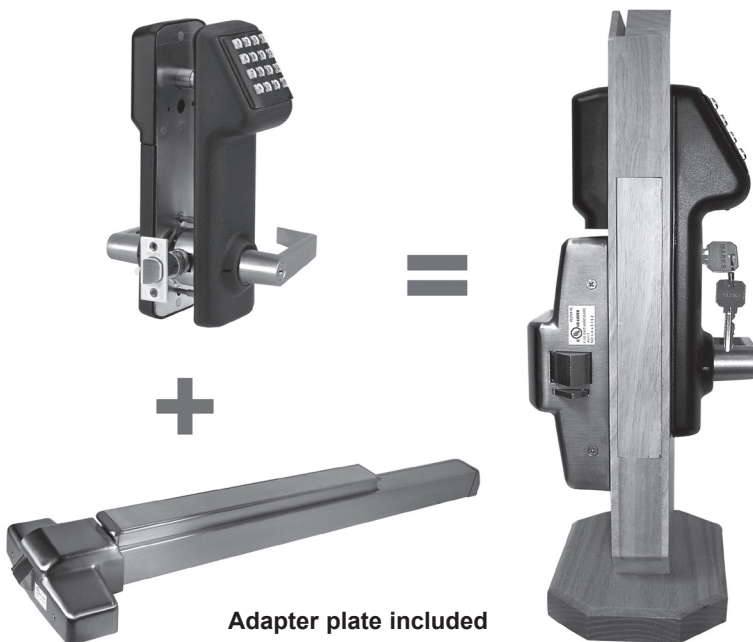

Adapter plate included

MARKS #	FUNCTION	PRICE
M9900LITE	Rim Panic with IQ7LITE	1076.76

IQ7LITE

IQ7 LITE Rim Exit Device Interface Specifications

- Door Thickness:** 1-3/4" standard; For thicker doors, Consult factory
- Handing:** Non-handed
- Key Override:** 1-1/8" Mortise cylinder, 6 pin w/2 keys
- Clutch:** The "Clutch" for trouble free service

M9900

- **Doors:** 1-3/4" thick standard.
- **End cover:** Flush mounted beveled "Panic Protector" design.
- **Strike:** Roller strike.
- **Rail Assembly:** Extruded Aluminum, 32D finish.
- **Dead latch Bolt:** Stainless Steel 3/4" throw.
- **Dead latch Bolt:** Stainless Steel 5/8".
- **Dogging feature:** Allen Key (M9900)
- **UL listed:** For "Panic Hardware" and Fire Rated Model 3 hour fire doors up to 38" x 86".
- **ANSI:** ANSI 156.3 (2001), requirements for Grade 1.
- 3 Hour Fire Rating
- **Finish:** 32D

ARCHITECH™ SERIES NETWORKX LOCKS

Ideal access control solution; elegantly blending advanced wireless access control convenience within any decor, in attractive, infinitely customizable designer locking form, in choice of trims and finishes.



N90L - Ideal for School and Campus



Features

- 5000 Users, 500 Scheduled Events & 40,000 Event Audit Trail
- Surface-Mount or Mortised - in Electronics and Battery Pack
- Lock available in Mortise and Cylindrical versions
- Real Time Clock - Uses 4 AA Batteries - 3 to 4 year battery life
- Operated via access card, fob, key fob etc
- DL-Windows Software for programming
- USB Radio Key Programming Method or Via NetworkX Gateways
- Manual Card Enrollment Option for Quick Installation
- Wireless programming range: up to 20 ft. from lock
- Easily, securely networked via 802.11 or ethernet, spanning a few or thousands of doors, in one building, a campus or multiple sites in an enterprise (also available in standalone model)
- Emergency Lockdown Keyfobs & Flashing Strobe Indicator, Available
- Programmable Lockdown/Unlock Privileges
- Cylindrical ArchiTech Locks neatly, quickly retrofit any standard door lock, with easy surface mount electronics, for use in all applications - Including wood and metal doors, for new and existing applications
- Customizable oval or square Access ID Reader, in black or silver and three levers to choose from - American 195, Crescent 295 & Titan 495
- Future-Proof Multi-Technology Access ID Credentials Replace Cumbersome Keys - HID® Prox, Mag Stripe, Smart Cards, PIV, keyfobs and remote buttons
- Powered by 4 off-the-shelf AA Batteries. 3 to 4 years, typ.
- Flexible System Monitoring, Control & Programming - Program locally using a USB Gateway or remotely across a wireless network (using free Alarm Lock DL-WINDOWS Windows- based software). Or, in Real-Time Enterprise platforms, using either Continental Access CA4K®, Lenel® OnGuard® or support via Software House® Connected Partner Program®

Specifications

- ANSI / BHMA Grade 1 Certified, UL Listed 3 Hours
- Includes standard lever rose hardware design
- Compatible with all 300+ optional architectural trim / lever or knob designs
- Stainless steel latch, 2-3/4" backset
- Auto-Reverse lock body tested to 6 million cycles
- Lock Body - Self cleaning long life motor
- Door closure monitor / electronic deadbolt monitor
- Key override standard or high-Security
- Optional integrated door position indicator switch

ArchiTech Series
NetworkX Locks

ARCHITECH™ SERIES NETWORK LOCKS

Electronics

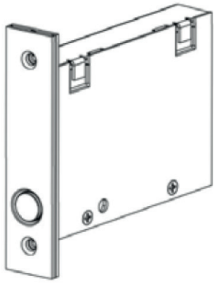

I - Inserted

J - Inserted BLE

MORTISED
NETWORK CONTROL
MODULE

S - Surface

T - Inserted BLE

L - Lockdown

M - Lockdown BLE

P - Privacy

Q - Privacy BLE

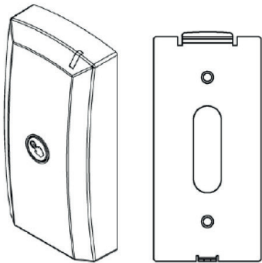

"SURFACE-MOUNTED" NETWORK
CONTROL UNIT
AND ITS MOUNTING PLATE

Wired Readers



1 - Prox Oval

2 - Prox Square



A - iClass Oval

B - iClass Square

C - Concealed
(Wood or Composite doors only)



M - Multi-Class
iClass/Prox



7 - Keypad Prox

Wireless Readers



F - Oval Wireless Prox



H - Horizontal KP/Prox



V - Vertical
KP/Prox



W - Square Glass
KP/Prox



Concealed
Electronics

Mortise-In Electronics
& Batteries

Cylindrical; Surface
Mounted Electronics

Mortise; Surface
Mounted Electronics

Keypad

ARCHITECH™ SERIES NETWORK LOCKS

ArchiTech Series Cylindrical Locks

Models	Base Price
N90	1318.81
R90	1318.81

Electronics	Add On
I	-
J	74.93
S	-
T	74.93
L	74.93
M	149.86
P	74.93
Q	149.86

Reader	Add On
1	-
2	-
7	74.93
A	74.93
B	74.93
C	-
D	149.86
E	149.86
F	149.86
H	149.86
V	149.86
W	149.86

Trim Type	Add On
195	-
295	-
495	-

Finish	Add On
3	-
4	42.65
10	42.65
10B	42.65
19	42.65
26	42.65
26D	-

Option	Add On
F7	15.00
F8	15.00
F12	22.00
F13	22.00
F14	15.00
F15	15.00
F19	15.00
F20	15.00
F21	15.00
G3	-10.00

Choice of Levers - Cylindrical Models



195 - American Lever

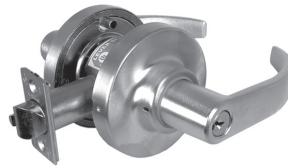

295 - Crescent Lever



495 - Titan Lever

No up-charge for Marks (Best) SFIC. Specify "RF" for SFIC

*Note: Please consult factory for availability of other finishes. Round rose place only available with cylindrical version (3.5" diameter). IC core models: tail piece included, core not included.

ArchiTech Series Network Locks

How to order ArchiTech Cylindrical Models

Base distribution cylindrical model P/N scheme

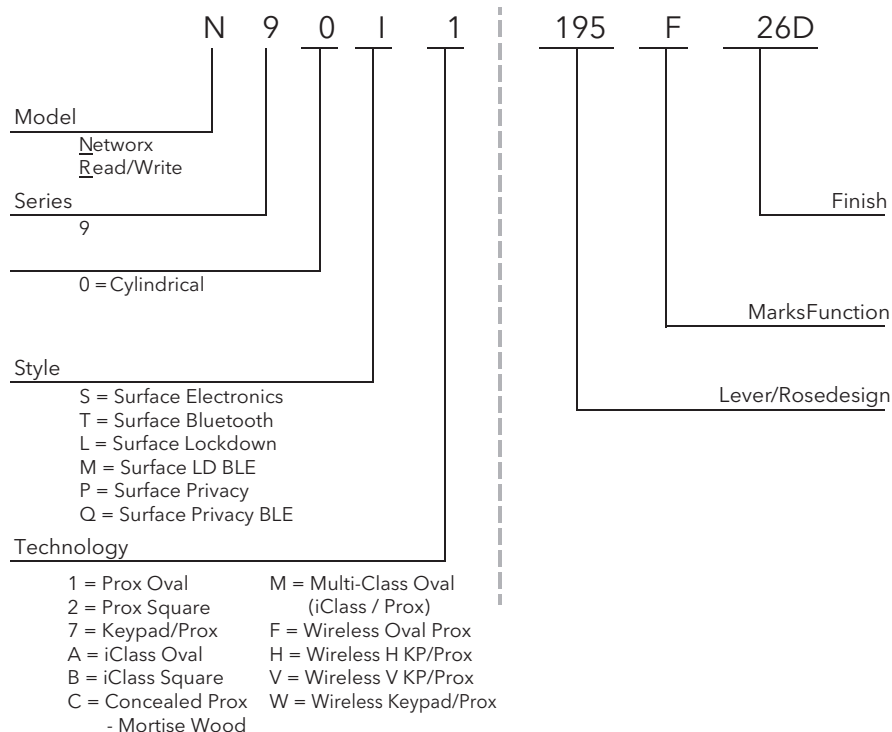

ARCHITECH™ SERIES NETWORK LOCKS

ArchiTech Series Mortise Locks

Models	Base Price	Electronics	Add On	Reader	Add On	Trim	Add On	Lever	Add On	Finish	Add On	Option	Add On
N95	1648.51	I	-	1	-	RQ	-	002	-	3	-	G1	-
R95	1648.51	J	74.93	2	-	RR	-	031	-	4	42.65	G3	-10.00
		S	-	7	74.93	RS	-	037A	-	5	-	G6	-
		T	74.93	A	74.93	RW	-	47C	-	10	42.65	G7	51.00
		L	74.93	B	74.93	RX	18.68	55	-	10B	42.65	G8	-
		M	149.86	C	-	RK	43.19	57	-	11	42.65		
		P	74.93	D	149.86	RL	61.29	72	-	14	42.65		
		Q	149.86	E	149.86	LA	156.23	77	-	15	42.65		
				F	149.86	CR	110.23	78	-	19	42.65		
				H	149.86	DR	156.23	82	-	20A	42.65		
				V	149.86			83	-	26	42.65		
				W	149.86			86	-	26D	-		
								92	-	32	-		
								96	-	32D	-		
								BH29	1156.47				

KNOBS	Round Knob 10	Ball Knob 20	Commerce Lever 037A	Metropolitan Lever 002	ROSES	RR: 2-9/16" dia.
						
LEVERS	Lucida Lever 47C	Copa Lever 031	Brompton Lever 55	Monaco Lever 57 Specify handing		RW: 2-9/16" dia.
						
	Towne Lever 72	Maxwell Lever 77	Omni Lever 78	Plaza Lever 82		RQ: 2-1/4" dia.
						
	Dayton Lever 83 Specify handing	Crescent Lever 86	American Lever 92	Titan Lever 96		RS: 2-1/4" dia.
						
						RX: 2-1/2" sq.
					RK: 2-1/2" sq.	
					RL: 1-1/2" sq.	
						

ArchiTech Series
Network Locks

Functions for Mortise Locks

CODE	FUNCTION	DESCRIPTION
FD	APARTMENT	Latch by lever either side except when outside locked by stop-button or projected deadbolt. Latch deadlocked by auxiliary latch or deadbolt & latch by key outside. Deadbolt by turn piece inside. Inside knob/lever retracts latch & deadbolt simultaneously, leaving outside locked.
E	STOREROOM	Latch by lever inside, key outside. Outside lever always rigid. Auxiliary latch deadlocks latch. Inside always open.
AD	AUTOMATIC DEADBOLT	Latch deadlocked by deadbolt automatically when door closes. Deadbolt & latch by key or redential outside. Inside lever retracts latch & deadbolt simultaneously, leaving outside locked.

ARCHITECH™ SERIES NETWORK LOCKS

How to order ArchiTech Mortise Models

Base distribution cylindrical model P/N scheme

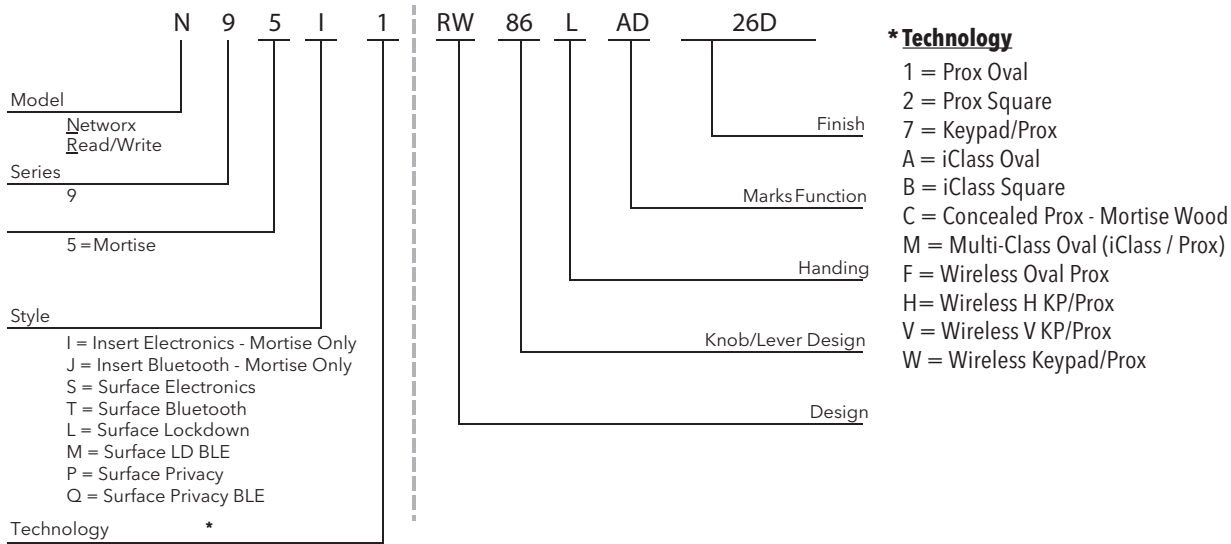

LOCK TYPE	READER TYPE												
		1	2	7	A	B	C	D	E	F	H	V	W
N90I	s/o	s/o	s/o	s/o	s/o	s/o	s/o	s/o	n/a	n/a	n/a	n/a	N/A
N90J	s/o	s/o	s/o	s/o	s/o	s/o	s/o	s/o	n/a	n/a	n/a	n/a	N/A
N90S	✓	✓	✓	✓	✓	n/a	s/o	n/a	n/a	n/a	n/a	n/a	N/A
N90T	✓	✓	✓	✓	✓	n/a	s/o	n/a	n/a	n/a	n/a	n/a	N/A
N90L	✓	✓	s/o	✓	✓	n/a	s/o	n/a	n/a	n/a	n/a	n/a	N/A
N90M	s/o	s/o	s/o	s/o	s/o	n/a	s/o	n/a	n/a	n/a	n/a	n/a	N/A
N90P	n/a	n/a	✓	n/a	n/a	n/a	n/a	n/a	n/a	n/a	n/a	n/a	N/A
N90Q	n/a	n/a	s/o	n/a	n/a	n/a	n/a	n/a	n/a	n/a	n/a	n/a	N/A
N95I	✓	✓	✓	✓	✓	✓	s/o	n/a	n/a	n/a	n/a	n/a	N/A
N95J	✓	✓	✓	✓	✓	✓	s/o	n/a	n/a	n/a	n/a	n/a	N/A
N95S	✓	✓	✓	✓	✓	n/a	s/o	n/a	n/a	n/a	n/a	n/a	N/A
N95T	✓	✓	✓	✓	✓	n/a	s/o	n/a	n/a	n/a	n/a	n/a	N/A
N95L	✓	✓	s/o	✓	✓	n/a	s/o	n/a	n/a	n/a	n/a	n/a	N/A
N95M	s/o	s/o	s/o	s/o	s/o	n/a	s/o	n/a	n/a	n/a	n/a	n/a	N/A
N95P	n/a	n/a	s/o	n/a	n/a	n/a	n/a	n/a	n/a	n/a	n/a	n/a	N/A
N95Q	n/a	n/a	s/o	n/a	n/a	n/a	n/a	n/a	n/a	n/a	n/a	n/a	N/A
R90I	s/o	s/o	s/o	s/o	s/o	s/o	s/o	s/o	s/o	s/o	s/o	s/o	S/O
R90J	✓	✓	s/o	s/o	s/o	s/o	s/o	s/o	s/o	s/o	s/o	s/o	S/O
R90S	✓	✓	s/o	s/o	s/o	n/a	s/o	s/o	s/o	s/o	s/o	s/o	S/O
R90T	✓	✓	s/o	s/o	s/o	n/a	s/o	s/o	s/o	s/o	s/o	s/o	S/O
R90L	✓	✓	s/o	s/o	s/o	n/a	s/o	s/o	s/o	s/o	s/o	s/o	S/O
R90M	s/o	s/o	s/o	s/o	s/o	n/a	s/o	s/o	s/o	s/o	s/o	s/o	S/O
R90P	n/a	n/a	✓	n/a	n/a	n/a	n/a	s/o	s/o	s/o	s/o	s/o	S/O
R90Q	n/a	n/a	s/o	n/a	n/a	n/a	n/a	s/o	s/o	s/o	s/o	s/o	S/O
R95I	✓	✓	✓	✓	✓	✓	s/o	s/o	s/o	s/o	ü	✓	
R95J	✓	✓	✓	✓	✓	✓	s/o	s/o	s/o	s/o	ü	✓	
R95S	✓	✓	✓	✓	✓	n/a	s/o	s/o	s/o	s/o	ü	✓	
R95T	✓	✓	✓	✓	✓	n/a	s/o	s/o	s/o	s/o	ü	✓	
R95L	✓	✓	s/o	✓	✓	n/a	s/o	s/o	s/o	s/o	s/o	S/O	
R95M	s/o	s/o	s/o	s/o	s/o	n/a	s/o	s/o	s/o	s/o	s/o	S/O	
R95P	n/a	n/a	s/o	n/a	n/a	n/a	n/a	s/o	s/o	s/o	s/o	S/O	
R95Q	n/a	n/a	s/o	n/a	n/a	n/a	n/a	s/o	s/o	s/o	s/o	S/O	

ArchiTech Series Network Locks

ARCHITECH™ SERIES NETWORKX LOCKS

ArchiTech™ Series Networkx Locks Parts and Accessories

PRODUCT	DESCRIPTION	PRICE
AL-IME2EXP	Wireless Expander designed to expand the coverage area of version 2 gateways. AC power required. Up to 7 expanders per version 2 gateway	374.66
AL-IME2-PIE	Plug-in wireless expander, as above – Plugs into standard AC outlet	374.66
AL-IME-USB	USB Gateway (not for lockdown)	793.40
AL-PRE2	Prox card enroller – HID and iClass	928.42
AL-NSM	Networkx Signal Meter	443.60
AL-NSG	Networkx Signal Generator	359.68
AL-PB	ArchiTech Power Booster	1942.25
ALHID1326	Proximity Access Cards 100 Per Box	519.12
ALHID1391	MicroProx Tag 10 per box	129.03
AL-IM3-80211	3rd Generation Hardware/Wireless Gateway	711.86
AL-IM3-POE	3rd Generation Hardware/Wireless POE Gateway	861.73
KH-36-10	Napco Branded Keyfob 10 pack	42.92
AL-4BKEYFOB	4 Button Remote Fob	167.52
AL-NETHIDNSPACK	Net Panel with HID reader	1413.07
AL-IDRW	Card Write-ReWriter	928.42

Use the iLock® App to unlock your Networkx ArchiTech™ Bluetooth® Series Door Lock in seconds!



Introducing iLock, the easy smartphone mobile solution for unlocking your Trilogy® ArchiTech Bluetooth Series Designer Access Control Locks from any smart device without the need to carry cumbersome ID cards or keys. Password protected access is secure through the use of Bluetooth LE® and proprietary encryption. Additionally, an optional feature can be utilized, requiring a password for each unlock request.

The Key is Your Smartphone & More Secure Technology

Any Smart Device can be the Access Key: Much more than an ID card displayed on your smartphone, for your security, ArchiTech & its iLock App are wirelessly linked together, each supplying its portion of stored encrypted data to provide secure access without a key, fuss or worry, ensuring user identities. A unique combination of convenience



and cloneproof peace of mind, the ArchiTech platform uses universally-compatible Bluetooth LE technology, so they can use any smart device to unlock ArchiTech on your door(s); and do so from afar, at a comfortable, customizable range of up to 30 feet away. For even greater security users can add an optional passcode, entered on their phone App.

ArchiTech Series
Networkx Locks

iLock App is available from both iTunes and the Google Play Store



MARKS USA

AMITYVILLE, N.Y. 11701

www.marksusa.com

DISTRIBUTED BY:

800-645-9445 • www.marksusa.com • sales@marksusa.com
www.napcolocking.com

Marks USA is a Division of NAPCO Security Technologies, Inc. (NASDAQ: NSSC) • NAPCO • Alarm Lock • Continental Access • Marks USA
ArchiTech, LifeSaver, Survivor, Hi-Security, iQwik, LocDown Thinline and Unilock are trademarks of Marks/NAPCO. Other trademarks listed are properties of their respective companies.