

# 5000 Series Electric Strike

*Works with cylindrical locksets up  
to a 5/8" throw latchbolt*

Also available in  
Complete One Box  
Solution



## The Grade 1, low profile solution for cylindrical locksets.

The HES 5000 series is a compact, high performance electric strike designed for low profile openings where there is limited space behind the jamb. Its strength is derived from a unique keeper pin locking design, enabling the 5000 to exceed the ratings of the frame, door and locking hardware. This field selectable fail secure/fail safe unit is easy to install and accommodates latchbolts up to 5/8" throw.

### Features

- Tamper resistant
- Static strength 1,500 lbs
- Dynamic strength 70 ft-lbs.
- Endurance 1,000,000 cycles
- Field selectable fail secure/ fail safe
- Non-handed
- Internally mounted solenoid
- Accommodates 1/2" - 5/8" latchbolt (5/8" with 1/8" door gap)
- Strike body depth 1-1/16"
- Plug-in connector
- Trim enhancer included
- SecuriCare five-year, no-fault, no questions asked warranty (Addition of SMART Pac® III extends the warranty to 10 years)

### Options

- LBM - Latchbolt monitor

### Accessories

- 157 Torx® screws
- 150 Strike Latch Guard
- HESCUT-MTK Metal Template Kit
- 2005M3 SMART Pac® III
- 2001M Plug-in Bridge Rectifier
- 2004M ElectroLynx® adapter
- 2006M Plug-in Buzzer
- 5104-1 Stackable Lip Extension
- 5104-1-1/4 Stackable Lip Extension
- 5104-1/2 Stackable Lip Extension



Grade 1



SecuriCare  
Warranty



Cylindrical  
Locksets



Field Selectable  
(Fail secure  
/Fail safe)



Dual Voltage  
12/24



PoE  
Friendly



Outdoor  
Rated



Burglary  
Rated

hes

ASSA ABLOY

## 5000 Series Electric Strike

### Certifications

- ANSI/BHMA A156.31, Grade 1
- RoHS Compliant
- UL 294 Listed
- UL 1034 Burglary-Resistant Listed and Suitable for Outdoor Use

### Specifications

#### Frame Application

- Metal
- Wood

#### Electrical

- Dual voltage 12/24 VDC/VAC
- 240 mA at 12 VDC
- 120 mA at 24 VDC
- PoE friendly

### Dimensions

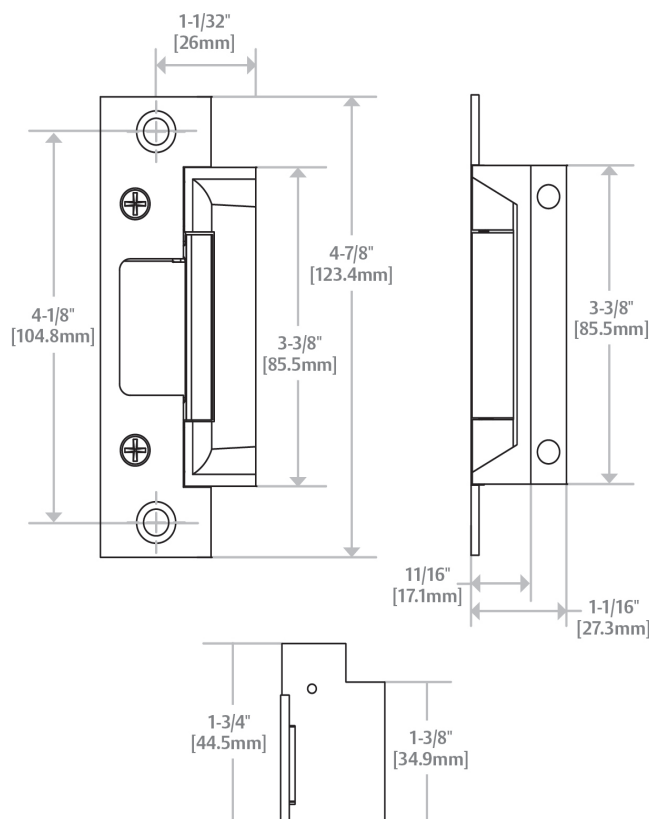

Diagram shown with 501 Option

## How to Order













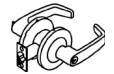

SERIES	MODEL	FINISH	OPTION (S)
<b>5000</b>	<b>C</b>	<b>- 630</b>	<b>- LBM</b>
<b>5000</b> Universal Electric Strike; faceplate option kits ordered separately	<b>C*</b> Complete Electric Strike; includes the 501 and 501A faceplates <b>(blank)</b> Strike Body Only	<b>630</b> Satin Stainless Steel	<b>(blank)</b> No Monitor <b>LBM</b> Latchbolt Monitor

\*Complete Pacs are only available in the 630 finish

FACEPLATE OPTIONS	FINISH
<b>502</b>	<b>- 613E</b>
<b>For Cylindrical Locksets (ANSI Metal)</b>	<b>605</b> Bright Brass
<b>501 Option 4-7/8" x 1-1/4"</b>	<b>606</b> Satin Brass
<b>For Cylindrical Locksets (Aluminum)</b>	<b>612</b> Satin Bronze
<b>501A Option 4-7/8" x 1-1/4"</b>	<b>613E</b> Dark Oxidized Satin Bronze Powder
<b>502 Option 7-15/16" x 1-7/16"</b>	<b>629</b> Bright Stainless Steel
<b>503 Option 6-7/8" x 1-1/4"</b>	<b>630</b> Satin Stainless Steel
<b>For Cylindrical Locksets (Wood)</b>	<b>BSP</b> Black Suede Powder
<b>504 Option 10" x 1-3/8"</b>	

NOTE: Electric strike compatibility is determined at time of electric strike product release. ASSA ABLOY is not responsible for incompatibility of products that have changed in design or craftsmanship by their respective manufacturers. When compatibility is a concern, contact Customer Support for application assistance.

# 5000/5200/5300 Series Faceplate Options

<p><b>OPERATION</b></p>		<p>After releasing the latchbolt, the keeper returns to the locked position.</p>
 <p><b>4-7/8" × 1-1/4"</b> [123.8mm × 31.75mm] <i>Square corners and flat faceplate</i></p>	<p><b>501 Option</b> <b>For use with:</b> Cylindrical locksets in ANSI metal jambs ANSI/BHMA Numbers: E09321, E09322, E09323</p>	
 <p><b>4-7/8" × 1-1/4"</b> [123.8mm × 31.75mm] <i>Radius corners and flat faceplate</i></p>	<p><b>501A Option</b> <b>For use with:</b> Cylindrical locksets or spring latch in aluminum frames. Includes universal mounting tabs. ANSI/BHMA Numbers: E09321, E09322, E09323</p>	 
 <p><b>7-15/16" × 1-7/16"</b> [201.6mm × 36.5mm] <i>Radius corners and flat faceplate</i></p>	<p><b>502 Option</b> <b>For use with:</b> Cylindrical locksets or spring latch in aluminum frames. Includes universal mounting tabs. ANSI/BHMA Numbers: E09321, E09322, E09323</p>	 
 <p><b>6-7/8" × 1-1/4"</b> [174.6mm × 31.75mm] <i>Radius corners and flat faceplate</i></p>	<p><b>503</b> <b>For use with:</b> Cylindrical locksets or spring latch in aluminum frames. Includes universal mounting tabs. ANSI/BHMA Numbers: E09321, E09322, E09323</p>	 
 <p><b>10" × 1-3/8"</b> [254mm × 34.9mm] <i>Radius corners and flat faceplate</i></p>	<p><b>504</b> <b>For use with:</b> Cylindrical locksets. Four-point mounting for wood installations ANSI/BHMA Numbers: E09321, E09322, E09323</p>	

"For use with" information is offered as a recommendation only. Reference should be made to the lockset manufacturer for proper installation instructions necessary to meet compatibility requirements.