

Life Safety and Security Door Hardware



EXIT ALARMS

EAX[®]-500 HOW TO ORDER

EXTENDED BYPASS

0 = Alarm must be manually turned off*

NON-EXTENDED BYPASS

(When arming delay expires, if the door is open, the alarm will sound)

2 = 2 min. Auto Re-arm

3 = 10 min. Auto Re-arm

4 = 20 min. Auto Re-arm

5 = Alarm sounds if door is open after arming delay. Manual Re-arm only

EAX-5

ARMING DELAY

0 = 15 Seconds*

1 = 1 Seconds

2 = 5 Seconds

WEATHERIZED

W = Weatherized

COLOR

For standard gray, leave blank

BK = Black

CYLINDER

If cylinder provided by others, leave blank

MC65 = Mortise Cylinder

IC7 = 7-pin IC Cylinder Housing (core not included)

IK7 = Cylinder InstaKey Housing (core not included)

SIGNAGE

For standard red with white letters in English, leave blank

RWS = Red with white letters Spanish

GWE = Green with white letters English

GWF = Green with white letters French

RWF = Red with white letters French Canadian

GWG = Green with white letters German

GWC = Green with white letters Chinese

GWE = Green with white letters German/English

SURFACE KIT

If door contact not required, leave blank

SK1 = Kit allows for wall mounting - includes (1) MS-1039S door contact

SK2 = Kit allows for wall mounting - includes (2) MS-1039S door contacts

SK3 = Kit allows for wall mounting - includes (1) MS-1059S door contact

SK4 = Kit allows for wall mounting - includes (2) MS-1059S door contacts

SK5 = Kit allows for wall mounting - includes (1) MS-2049 door contact

SK6 = Kit allows for wall mounting - includes (2) MS-2049 door contacts

MISCELLANEOUS

If not required, leave blank

KS = Key Stop, factory installed

STATUS INDICATOR

If status indicator not required, leave blank

SI = Status Indicator On



Detex products can expose you to chemicals including Chromium (hexavalent compounds) and Lead, which are known to the State of California to cause cancer and birth defects or other reproductive harm. For more information go to www.detex.com/prop65

* SK1 thru SK6 Kit Options not available in Weatherized

EAX® EXIT ALARMS

EAX-500

Battery Powered Door or Wall Mount Exit Alarm

The Detex EAX-500 Series is designed for applications requiring a battery-powered alarm on secured doors. The alarm, with approximately 100dB, will sound when an unauthorized exit occurs. The redesigned shape and smaller size of the EAX-500 makes it the ideal choice for quick and easy installations on emergency exit and restricted doors.

Shown with mortise cylinder
(cylinder sold separately)

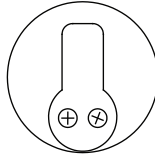

Benefits

- Low cost, self-contained door alarm with piezo horn that sounds to warn unauthorized use of a door or gate
- Secure, tamper resistant housing
- Quick, easy installation saves time and money
- Door or wall mount

Features

- Patented plastic template allows for foolproof alignment of internal magnetic door contact and accurate installation
- Patented cam assembly automatically adjusts for different sizes of cylinders without use of spacers
- Modern graphics on cover to demonstrate key rotation and operation
- Tapered cover allows for installation on narrow stile doors
- Alarm can only be silenced by proper control key
- 9VDC battery operated with Low Battery Alert
- Intelligent circuit senses the external magnet location automatically and sets the correct door handing
- 100 dB piezo alarm
- Key required to reset alarm
- LED visual and audible arming indicators
- Field selectable 2-minute auto rearm, if desired
- Field selectable status indicators, if desired

Mechanical Options

- EAX-500 may be ordered in several kit configurations:
 - SK1 Kit allows for wall mounting and includes (1) white MS-1039S door contact
 - SK2 Kit allows for wall mounting and includes (2) white MS-1039S door contacts
 - SK3 Kit allows for wall mounting and includes (1) brown MS-1059S door contact
 - SK4 Kit allows for wall mounting and includes (2) brown MS-1059S door contacts
- SK5 Kit allows for wall mounting and includes (1) grey MS-2049S door contact
- SK6 Kit allows for wall mounting and includes (2) grey MS-2049S door contacts
- KS - Key Stop (Key removed only when armed)
- OKC - Outside Key Control (Rim Cylinder required)
- EAX-500SK includes exit alarm prepped for wall mounting, and surface magnetic door contacts - specify cover lock # - additional surface contacts can be ordered separately (add suffix "xMC65 or xIC7" to include factory installed cylinder)

Electrical Options

Other EAX Exit Alarms Include:

- EAX-500W- Weatherized Battery Powered
- EAX-2500 - AC Powered
- EAX-3500 includes timed bypass alarm, rechargeable battery (mortise cylinder sold separately)

- EAX-3500FK includes timed bypass alarm, rechargeable battery, flush magnetic switch and plug-in 24VDC transformer

- EAX-3500SK includes timed bypass alarm, rechargeable battery, surface magnetic switch and plug-in 24VDC transformer

Accessories

- MC65 - Detex Mortise Cylinder pre-installed at factory
- IC7 - 7 pin interchangeable core housing, pre-installed at factory (Compatible with most standard 7 pin IC format cores)

Technical Information

- Machine and Self-Drilling Screws (Std.)
- Optional Sex Nuts or Security Torx Screws available
- Optional Cylinder Nut Wrench P/N: 103779

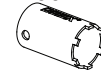

Finishes

- GY - Grey
- BK - Black

Dimensions

Front and Side View

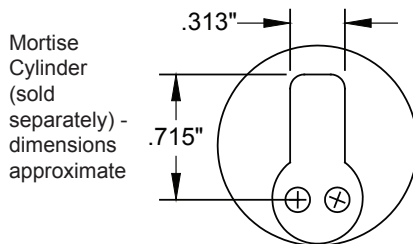
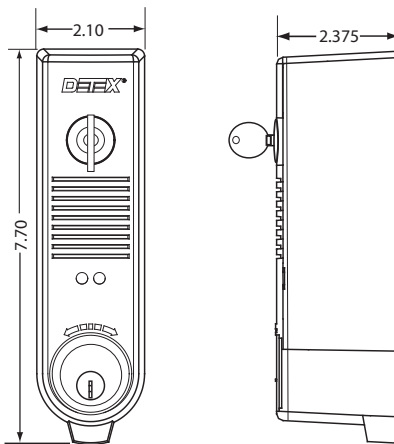

Riser Diagram

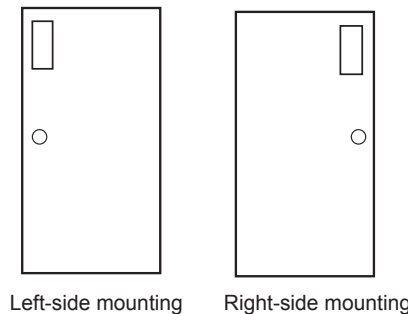

Left-side mounting Right-side mounting

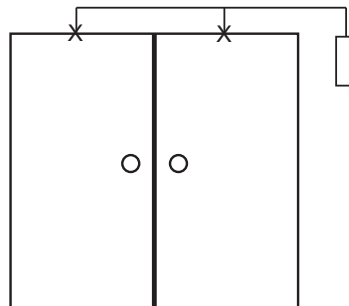

Door switch actuated

Double door application as shown above available with EAX-500, EAX-2500 and EAX-3500.

Note: Double door application as shown above **not** available with EAX-500W weatherized alarm.

Listings and Approvals



UL Classified Miscellaneous Fire Door Accessory



ANSI/BHMA A156.29

Detex Limited Warranty

3 Year Limited Manufacturer's Warranty

Where Trust is Built™

DETEX
Life Safety, Security and Security Assurance

Detex Corporation
302 Detex Drive
New Braunfels, Texas 78130-3045 USA
PH. (830) 629-2900
(800) 729-3839
FAX (800) 653-3839
<http://www.detex.com>
USA Sales:
marketing@detex.com
International Sales:
export@detex.com

Cancer & Reproductive Harm - www.detex.com/prop65

EAX® EXIT ALARMS

EAX-500W

Battery Powered Door Mounted Weatherized Exit Alarm

The Detex EAX-500W Weatherized Exit Alarm is designed for applications that require a battery-powered alarm on secured doors, particularly emergency exits that open to the outdoors or wet environment. The alarm, with approximately 100dB, will sound when an unauthorized exit occurs. The redesigned shape and smaller size of the EAX-500W makes it the choice for quick and easy installations on emergency exit and restricted doors and gates.

Shown with mortise cylinder
(cylinder sold separately)

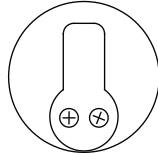

Benefits

- Low cost, self-contained door alarm with piezo horn that sounds to warn unauthorized use of a door or gate
- Weatherized for outdoor environments
- Door or wall mount
- Secure, tamper resistant housing
- Quick, easy installation saves time and money

Features

- Patented plastic template allows for foolproof alignment of internal magnetic door contact and accurate installation
- Tapered cover allows for installation on narrow stile doors
- Intelligent circuit senses the external magnet location automatically and sets the correct door handing
- Patented cam assembly automatically adjusts for different sizes of cylinders without use of spacers
- Alarm can only be silenced by proper control key
- Extended bypass (now a standard feature) allows alarm to remain bypassed when door is open and automatically rearm upon door closing
- Modern graphics on cover to demonstrate key rotation and operation
- 100 dB piezo alarm
- 9VDC battery operated with Low Battery Alert
- LED visual and audible arming indicators
- Field selectable 2-minute auto rearm, if desired
- Field selectable status indicators, if desired
- Weatherized electronics certified to Driving Rain and Salt Fog Test (see Listings and Approvals)

Mechanical Options/Accessories

- KS - Key Stop (Key removed only when armed)
- OKC - Outside Key Control (Rim Cylinder required)
- MC65 - Detex Mortise Cylinder pre-installed at factory
- IC7 - 7 pin interchangeable core housing, pre-installed at factory (Compatible with most standard 7 pin IC format cores)

Electrical Options

Other EAX Exit Alarms (non Weatherized) Include:

- EAX-500 - Battery Powered
- EAX-2500 - AC Powered
- EAX-3500 - Timed Bypass and Rechargeable Battery

Other Weatherized EAX Exit Alarms Include:

- EAX-500W - Battery Powered, Timed Bypass

Technical Information

• Door Types - Wood, Hollow Metal, Fiberglass or Aluminum

• Inswinging door applications use accessory PN 102644 (Inswing Door Kit)

• Optional Cylinder Nut Wrench P/N: 103779

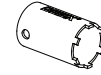

• Machine and sheet metal screws (Std.)

Finishes

• GY - Grey

• BK - Black

Dimensions

Front and Side View

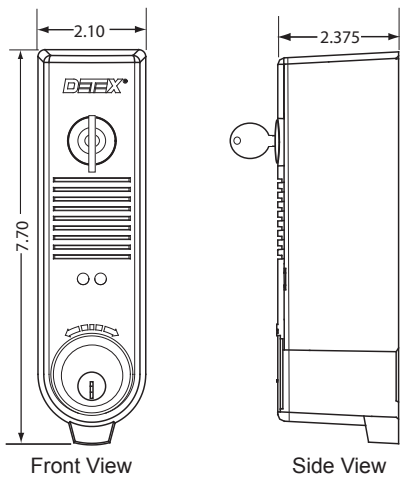

Mortise Cylinder (sold separately) - dimensions approximate

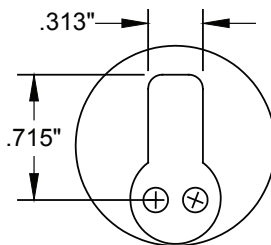

Riser Diagram

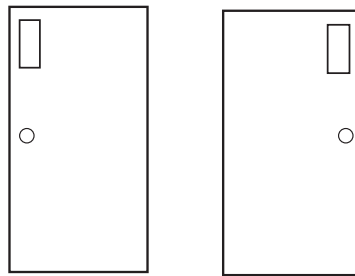

Left-side mounting

Right-side mounting

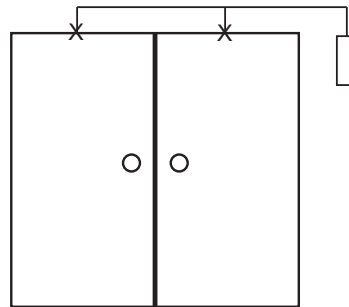

Door switch actuated

Listings and Approvals



UL Listed Miscellaneous Fire Door Accessory

MIL-STD 810F (G), Method 509.4 (Salt Fog Test)

MIL-STD 810F (G), Method 506.4 (Driving Rain), Procedure 1



ANSI/BHMA A156.29

Detex Limited Warranty

3 Year Limited Manufacturer's Warranty

Where Trust is Built™

DETEX®

Life Safety, Security and Security Assurance

Detex Corporation
302 Detex Drive
New Braunfels, Texas 78130-3045 USA

PH. (830) 629-2900

(800) 729-3839

FAX (800) 653-3839

http://www.detex.com

USA Sales:

marketing@detex.com

International Sales:

export@detex.com

⚠ Cancer & Reproductive Harm - www.detex.com/prop65

EAX[®]-2500 HOW TO ORDER

EXTENDED BYPASS

- 0** = Alarm must be manually turned off; or may be field selected for 2 min. Auto Re-arm
- 3** = Alarm must be manually turned off; or may be field selected for 10 min. Auto Re-arm
- 4** = Alarm must be manually turned off; or may be field selected for 20 min. Auto Re-arm
- 5** = Alarm must be manually turned off; or may be field selected for 3.3 hours. Auto Re-arm

EAX-25

ARMING DELAY

- 0** = 15 Second Arming Delay
- 1** = 1 Second Arming Delay
- 2** = 5 Second Arming Delay
- 4** = 4 Minute Arming Delay

BACK BOX

If no back box needed, leave blank

- S** = Surface Mounting
- F** = Flush Mounting
- SK1** = Surface Kit: Surface mount back box, 24 VAC transformer, surface door contacts
- FK1** = Flush Kit: Flush mount back box, 24 VAC transformer, flush door contacts
- C** = Conversion kit for retrofit from EA-2500F

COLOR

For standard gray, leave blank
BK = Black

CYLINDER

If cylinder provided by others, leave blank

- MC65** = Mortise Cylinder
- IC7** = 7-pin IC Cylinder Housing (core not included)
- IK7** = Cylinder InstaKey Housing (core not included)

POWER

If power provided by others, leave blank

- IN** = Includes 220 Transformer
- 277** = Includes 277 Transformer
- L9** = Remove 9 volt Backup Battery

MISCELLANEOUS

If not required, leave blank
KS = Key Stop, factory installed

SIGNAGE

For standard red with white letters in English, leave blank

- RWS** = Red with white letters Spanish
- GWE** = Green with white letters English
- GWF** = Green with white letters French
- RWF** = Red with white letters French Canadian
- GWG** = Green with white letters German
- GWC** = Green with white letters Chinese
- GWE** = Green with white letters German/English

STATUS INDICATOR

If status indicator not required, leave blank
SI = Status Indicator On

NOTE: * = default

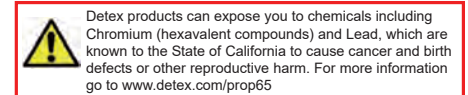

September 5, 2018

EAX® EXIT ALARMS

EAX-2500

AC/DC External Powered Wall Mount Exit Alarm

The Detex EAX-2500 Series Exit Alarm is designed for applications requiring a hardwired AC/DC alarm on secure doors. The alarm, with approximately 100dB, will sound when an unauthorized exit occurs. The smaller size of the EAX-2500, which is designed to fit in a standard 4"x4" outlet box, makes it the choice for quick and easy installations on emergency exit and restricted doors.



Specify EAX-2500SxMC65



Specify EAX-2500SxBKxMC65

Shown with mortise cylinder
(cylinder sold separately)

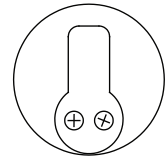

Benefits

- Field selectable features allow customer to choose status indicators and auto rearm options
- 100dB piezo horn provides security for restricted doors
- Easy to install using ordinary tools to save time and money
- New graphics on cover are easy to understand and make key operation simple
- Available in either gray or black to blend with any décor

Features

- Surface and flush mount available using 4"x4" double switch/outlet box
- Patented cam assembly automatically adjusts for different size cylinders without spacers
- Inside Key Control uses mortise cylinder with standard Yale cam
- AC/DC hardwired power with optional 9VDC backup battery
- Low battery alert is field selectable
- Silent arming feature is field selectable
- 100dB piezo horn
- Key required to reset alarm
- Tamper resistant housing and cover protects electronics
- Bypass input available
- Relay output for signaling external accessories
- Field selectable 2-minute auto rearm, if desired

Mechanical Options

- KS - Key Stop (Key removed only in on position)
- EAX-2500 Flush or Surface
- EAX-2500FK1 - Complete kit contains alarm, warning sign, flush back box, MS-2049F magnetic switch and 24VAC transformer (add suffix "xMC65 or xIC7" to include factory installed cylinder)
- EAX-2500SK1 - Complete kit contains alarm, warning sign, surface back box, MS-2049S magnetic switch and 24VAC transformer (add suffix "xMC65 or xIC7" to include factory installed cylinder)

Technical Information

- 7 pin cylinder requires 1/4-inch collar

Other EAX Exit Alarms Include

- EAX-500 - Battery Powered
- EAX-500W - Weatherized Battery Powered
- EAX-3500 - Timed Bypass and Rechargeable Battery
- EAX-300 - Door Prop
- EAX-300W - Weatherized Door Prop

Accessories

- IC7 - Interchangeable mortise cylinder (can be factory installed)
- MC65 - Mortise cylinder (can be factory installed)
- 102640 (EAX-2500C) Conversion Kit
- MS-2049, MS-1039, MS-1059 - Magnetic Switch
- Optional Cylinder Nut Wrench P/N: 103779



Riser Diagram

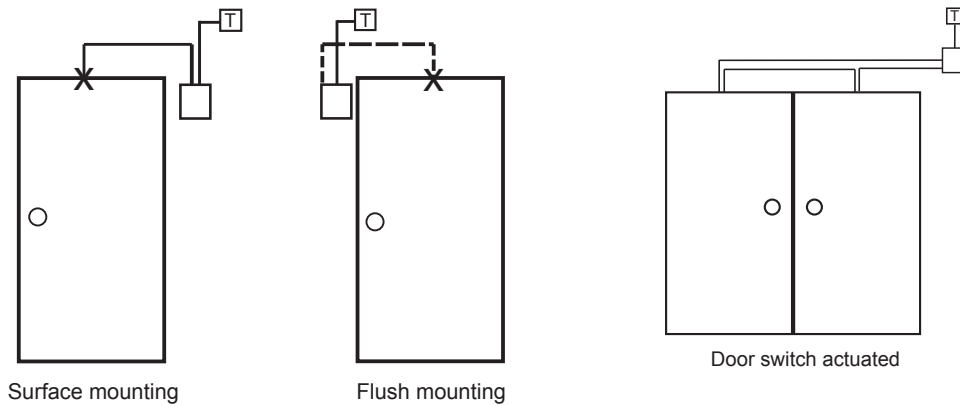

Double door application as shown above available with EAX-500, EAX-300, EAX-2500 and EAX-3500.
Note: Double door application as shown **not** available with EAX-300W or EAX-500W weatherized alarms.

Dimensions

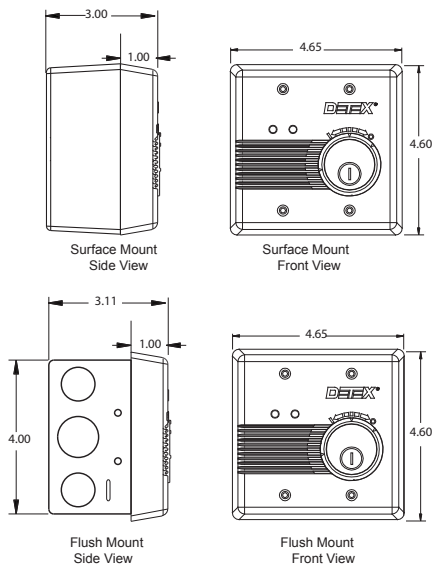

EAX-2500C Conversion Kit Dimensions (P/N 102640)

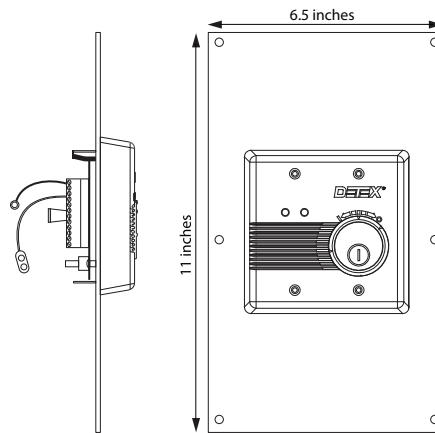

Detex Limited Warranty

3 Year Limited Manufacturer's Warranty



Detex Corporation
 302 Detex Drive
 New Braunfels, Texas 78130-3045 USA
 PH. (830) 629-2900
 (800) 729-3839
 FAX (800) 653-3839
<http://www.detex.com>
 USA Sales:
marketing@detex.com
 International Sales:
export@detex.com

Cancer & Reproductive Harm - www.detex.com/prop65

EAX® SERIES

EAX-2545

AC/DC External Powered Wall Mount Exit Alarm With 4 Minute Arming Delay/Non Extended Bypass

The Detex EAX-2545 Series Exit Alarm is designed for applications requiring a hardwired AC/DC alarm on secure doors. The alarm, with approximately 100dB, will sound when an unauthorized exit occurs. The smaller size of the EAX-2545, which is designed to fit in a standard 4"x4" outlet box, makes it the choice for quick and easy installations on emergency exit and restricted doors.



Specify EAX-2545SxMC65



Specify EAX-2545SxBKxMC65

Benefits

- Field selectable features allow customer to choose status indicators, silent arming and auto reararm options
- 100dB piezo horn provides security for restricted doors
- Easy to install using ordinary tools to save time and money
- New graphics on cover are easy to understand and make key operation simple
- Available in either gray or black to blend with any décor
- Tamper resistant housing and cover protects electronics

Features

- Surface and flush mount available using 4"x4" double switch/outlet box
- 4 minute Arming Delay - Door(s) can be opened and closed repeatedly during the 4 minute Arming Delay. At the end of Arming Delay, if door(s) are open, alarm sounds. If door(s) are closed, alarm automatically arms.
- AC/DC hardwired power with optional 9VDC backup battery
- Low battery alert is field selectable
- Silent arming feature is field selectable
- Alarm must be manually turned off
- Relay output for signaling external accessories
- Patented cam assembly automatically adjusts for different size cylinders without spacers
- Inside Key Control uses mortise cylinder with standard Yale cam

Mechanical Options

- KS - Key Stop (Key removed only when armed)
- EAX-2545 Flush or Surface
- EAX-2545FK1 - Complete kit contains alarm, warning sign, flush back box, MS-2049F magnetic switch and 24VAC transformer (add suffix "xMC65 or xIC7" to include factory installed cylinder)
- EAX-2545SK1 - Complete kit contains alarm, warning sign, surface back box, MS-2049S magnetic switch and 24VAC transformer (add suffix "xMC65 or xIC7" to include factory installed cylinder)

Other EAX Exit Alarms Include

- EAX-500 - Battery Powered
- EAX-500W - Weatherized Battery Powered
- EAX-3500 - Timed Bypass and Rechargeable Battery
- EAX-300 - Door Prop
- EAX-300W - Weatherized Door Prop

Accessories

- IC7 - Interchangeable mortise cylinder (can be factory installed)
- MC65 - Mortise cylinder (can be factory installed)
- MS-2049, MS-1039, MS-1059 - Magnetic Switch
- Optional Cylinder Nut Wrench P/N: 103779



Dimensions

Front and Side View

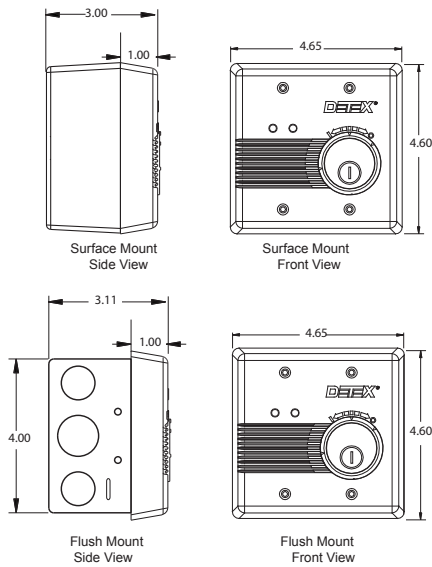

Riser Diagram

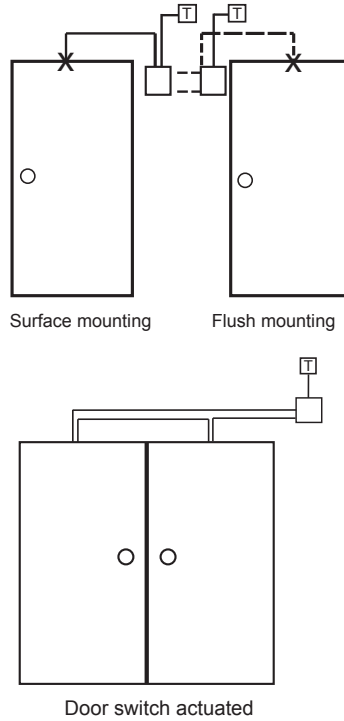

Double door application as shown above available with EAX-500, EAX-300, EAX-2545 and EAX-3500.

Note: Double door application as shown above **not** available with EAX-300W or EAX-500W weatherized alarms.

Detex Limited Warranty

3 Year Limited Manufacturer's Warranty



Where Trust is Built™
DETEX®
 Life Safety, Security and Security Assurance

Detex Corporation
 302 Detex Drive
 New Braunfels, Texas 78130-3045 USA
 PH. (830) 629-2900
 (800) 729-3839
 FAX (800) 653-3839
<http://www.detex.com>
 USA Sales:
marketing@detex.com
 International Sales:
export@detex.com

EAX® EXIT ALARMS

EAX-3500

Timed Bypass Exit Alarm and Rechargeable Battery

The Detex EAX-3500 is designed for applications requiring a hard-wired, timed-bypass alarm with rechargeable backup battery. The 100dB alarm will sound when someone attempts an unauthorized exit. The EAX-3500 can be temporarily bypassed for deliveries and trash removal, but reminds manager to close and secure the door.

Shown with cylinder (mortise cylinder sold separately)



Benefits

- Allows manager to temporarily bypass the alarm, but does not allow the alarm to be turned off
- Reminds manager to close and secure the door, minimizing door prop time
- Minimizing door prop time saves energy costs
- Minimizing door prop time reduces exposure to theft and threat of robbery
- Simple, on-the-cover instructions make operation easy
- LEDs illustrate armed status and bypass time, allowing quick easy reference
- Alarm demands attention even in noisy environments
- Tamper-resistant housing and circuits prevent dishonest employees from defeating alarm
- Mortise cylinder sold separately, allowing alarm to be keyed to existing master-key system, helping to maintain key control

Features

- Hard-wired low voltage power with rechargeable battery insures uninterrupted secure power feed
- Maximum allowable bypass time can be factory set or field-adjusted to 5, 10, 20 or 40 minutes
- Bypass time is easily set using two simple slide jumpers, located inside secured enclosure
- 100dB alarm, powered by 12 to 24 VAC and rechargeable backup battery (included)
- Low battery alert
- Rechargeable backup battery provides 72-hours of operation
- Timed bypass allows alarm to remain bypassed for allotted minutes, automatically rearming upon door closing
- Accepts 5, 6 or 7-pin standard and interchangeable core mortise cylinders with a standard Yale cam
- Patented cam assembly automatically adjusts for different size/length cylinders without the use of additional spacers or cylinder collars
- Resetting the alarm can only be accomplished with a control key

Mechanical Options

- EAX-3500 includes surface mount timed-bypass alarm, rechargeable battery (mortise cylinder sold separately)
- EAX-3500SK includes surface mount timed-bypass alarm, rechargeable battery, surface magnetic switch and plug-in 24VAC transformer (mortise cylinder sold separately)
- EAX-3500FK includes flush mount timed-bypass alarm, rechargeable battery, flush magnetic switch and plug-in 24VAC transformer (mortise cylinder sold separately)

Accessories

- IC7 - Interchangeable core mortise cylinder
- MC65 - Mortise cylinder
- Optional Cylinder Nut Wrench P/N: 103779



Technical Information

- Machine and Self Drilling Screws (Std.)
- Amp Draw - .083 Amps @ 24 VDC (Alarmed)
- .110 Amps @ 24 VDC (Door Prop)

Dimensions

Back - Side View

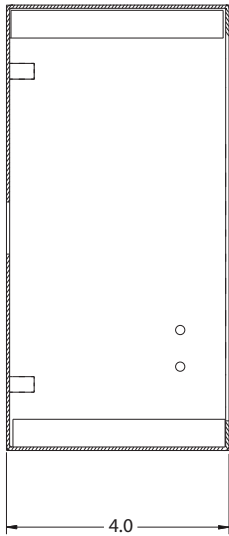

Front View

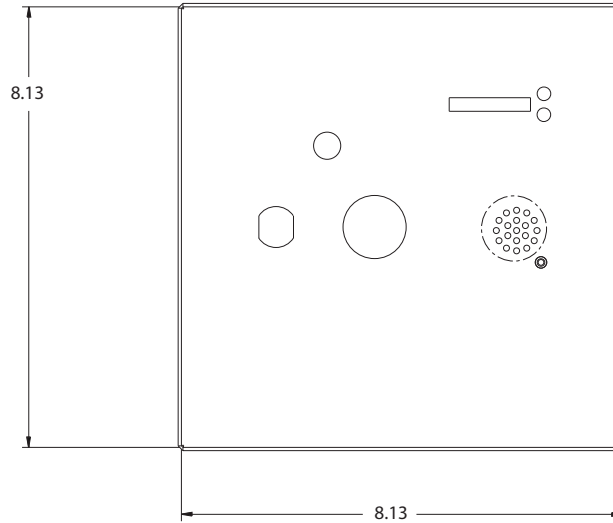

Cover - Side View

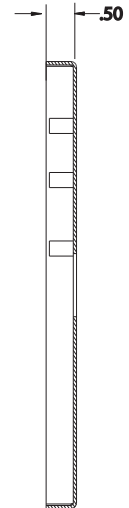

Riser Diagram

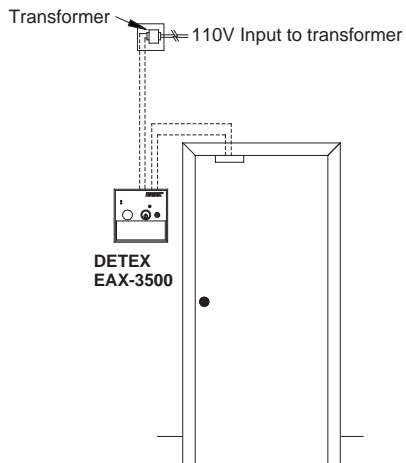

Listings and Approvals



UL Listed



ANSI/BHMA A156.29

Detex Limited Warranty

3 Year Limited Manufacturer's Warranty



Detex Corporation
 302 Detex Drive
 New Braunfels, Texas 78130-3045 USA
 PH. (830) 629-2900
 (800) 729-3839
 FAX (800) 653-3839
 http://www.detex.com
 USA Sales:
 marketing@detex.com
 International Sales:
 export@detex.com

Cancer & Reproductive Harm - www.detex.com/prop65

EAX[®]-300 HOW TO ORDER

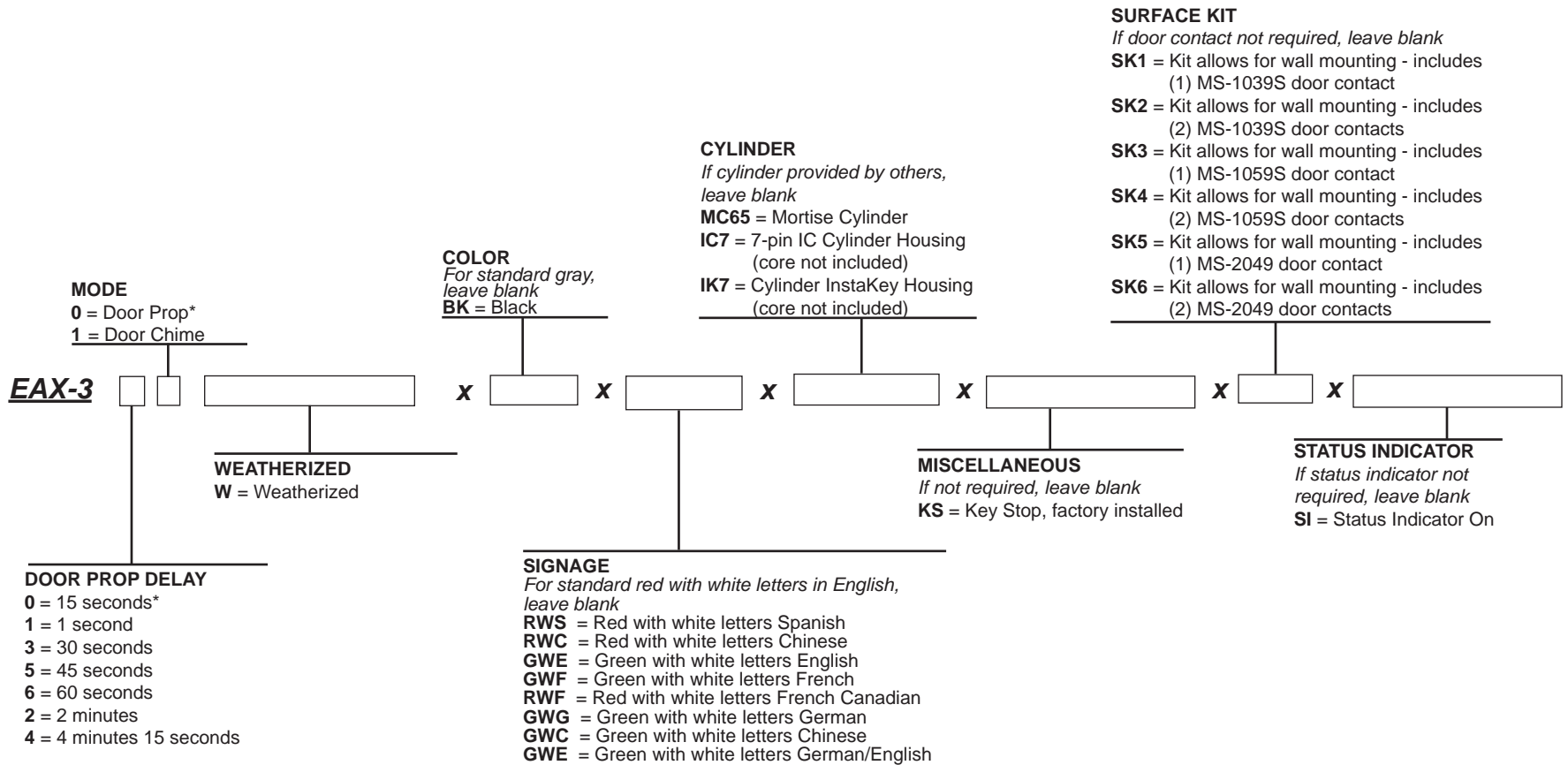

NOTE: * = default

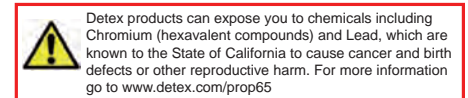

EAX[®] EXIT ALARMS

EAX-300

Battery Powered Door Propped Alarm

The Detex EAX-300 Series is designed for applications where doors may be used for egress or ingress, but may not be held or propped open. Door open times from 1 second to 4 minutes (15 second default) are field selectable. The smaller size makes installation quick and easy.

Shown with mortise cylinder
(cylinder sold separately)

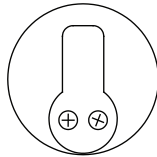

Benefits

- Low cost, solution to propped open doors
- Door or wall mount
- Helps keep energy costs down by ensuring doors are closed
- Quick, easy installation saves time and money
- Alarm silences when door is closed, no waiting for key-holder to arrive

Features

- Secure, tamper resistant housing
- Patented plastic template assures accurate installation by providing foolproof alignment with internal magnetic door contact
- Tapered cover allows for installation on narrow stile doors
- Intelligent circuit senses the external magnet location automatically and sets the correct door handing
- 100 dB piezo alarm
- 9VDC battery operated with Low Battery Alert
- LED visual arming indicators

Field Selectable Door Prop Times

Door Prop Timer	LED indication
1 second	1 GREEN flash
15 seconds (Default)	1 RED flash - 5 GREEN flashes
30 seconds	3 RED flashes
45 seconds	4 RED flashes - 5 GREEN flashes
1 minute	1 RED & GREEN simultaneous flash
2 minutes	2 RED & GREEN simultaneous flashes
4 minutes	4 RED & GREEN simultaneous flashes

Mechanical Options

- EAX-300 may be ordered in several kit configurations:

SK1 Kit allows for wall mounting and includes (1) white MS-1039S door contact

SK2 Kit allows for wall mounting and includes (2) white MS-1039S door contacts

SK3 Kit allows for wall mounting and includes (1) brown MS-1059S door contact

SK4 Kit allows for wall mounting and includes (2) brown MS-1059S door contacts

SK5 Kit allows for wall mounting and includes (1) grey MS-2049S door contact

SK6 Kit allows for wall mounting and includes (2) grey MS-2049S door contacts

- KS - Key Stop, factory installed
- SI - Status Indicator On

Electrical Options

- Weatherized for use on gates or doors that are subjected to inclement weather

Accessories

- MC65 - Detex Mortise Cylinder pre-installed at factory

- IC7 - 7 pin interchangeable core housing, pre-installed at factory (Compatible with most standard 7 pin IC format cores)

- IK7 - Cylinder InstaKey Housing

Technical Information

- Machine and self-drilling screws

- Optional Cylinder Nut Wrench P/N: 103779



Finishes

- GY - Grey

- BK - Black

Dimensions

Front and Side View

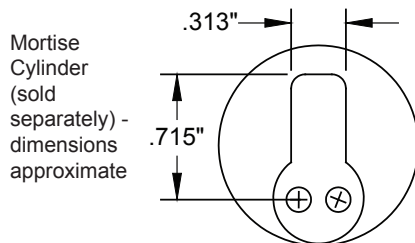
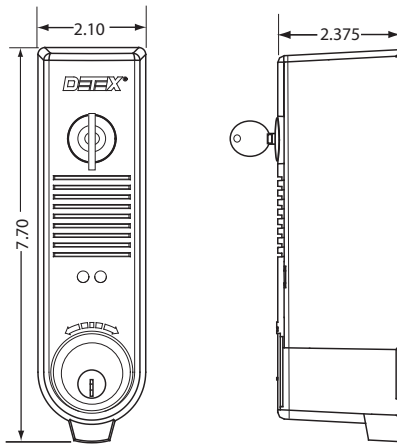

Riser Diagram

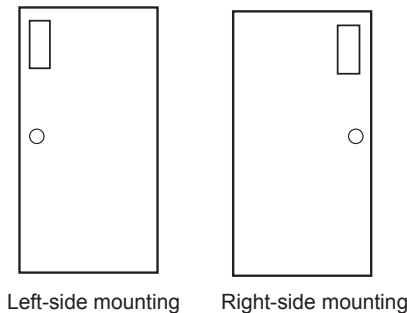

Listings and Approvals



UL Listed Miscellaneous Fire Door Accessory



ANSI/BHMA A156.29

Detex Limited Warranty

3 Year Limited Manufacturer's Warranty



Detex Corporation
302 Detex Drive
New Braunfels, Texas 78130-3045 USA
PH. (830) 629-2900
(800) 729-3839
FAX (800) 653-3839
<http://www.detex.com>
USA Sales:
marketing@detex.com
International Sales:
export@detex.com

Cancer & Reproductive Harm - www.detex.com/prop65

EAX® EXIT ALARMS

EAX-300W

Battery Powered Weatherized Door Propped Alarm

The Detex EAX-300W Series is designed for applications where doors that open to the outdoors or wet environments may be used for egress or ingress, but may not be held or propped open. Door open times from 1 second to 4 minutes (15 second default) are field selectable. The smaller size makes installation quick and easy on doors or gates.

Shown with mortise cylinder
(cylinder sold separately)

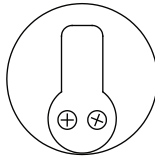

Benefits

- Low cost, solution to propped open doors
- Weatherized for use on gates or doors that are subjected to inclement weather
- Quick, easy installation saves time and money
- Door or wall mount
- Alarm silences when door is closed, no waiting for key-holder to arrive
- Helps keep energy costs down by ensuring doors are closed

Features

- Secure, tamper resistant housing
- Patented plastic template assures accurate installation by providing foolproof alignment with internal magnetic door contact
- Weatherized electronics certified to driving rain and salt fog test (see Listings & Approvals)
- Tapered cover allows for installation on narrow stile doors
- Intelligent circuit senses the external magnet location automatically and sets the correct door handing
- 100 dB piezo alarm
- 9VDC battery operated with Low Battery Alert
- LED visual arming indicators

Mechanical Options

- KS - Key Stop, factory installed (always armed when key removed)
- SI - Status Indicator On

Field Selectable Door Prop Times

Door Prop Timer	LED indication
1 second	1 GREEN flash
15 seconds (Default)	1 RED flash - 5 GREEN flashes
30 seconds	3 RED flashes
45 seconds	4 RED flashes - 5 GREEN flashes
1 minute	1 RED & GREEN simultaneous flash
2 minutes	2 RED & GREEN simultaneous flashes
4 minutes	4 RED & GREEN simultaneous flashes

Electrical Options

Other EAX Door-Propped Alarms (non Weatherized) Include:

- EAX-300 - Battery Powered

Other EAX Exit Alarms (non Weatherized) Include:

- EAX-500 - Battery Powered
- EAX-2500 - AC Powered
- EAX-3500 - Timed Bypass and Rechargeable Battery

Other Weatherized EAX Exit Alarms Include:

- EAX-500W - Battery Powered, Timed Bypass

Accessories

- MC65 - Detex Mortise Cylinder pre-installed at factory

- Optional Cylinder Nut Wrench P/N: 103779



- IC7 - 7 pin interchangeable core housing pre-installed at factory (Compatible with most standard 7 pin IC format cores)

- IK7 - Cylinder InstaKey Housing pre-installed at factory

Technical Information

- Door Types - Wood, Hollow Metal, Fiberglass or Aluminum

- Machine and self-drilling screws

- Inswinging door/gate applications use accessory PN 102644 (Inswing Door Kit)

- Optional Cylinder Nut Wrench P/N: 103779



Finishes

- GY - Grey

- BK - Black

Dimensions

Front and Side View

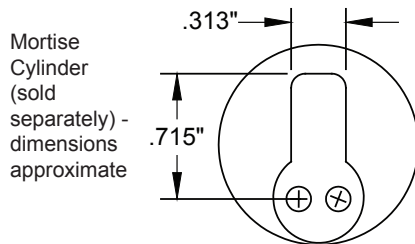
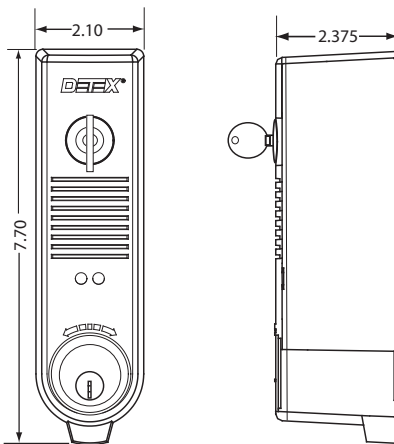

Riser Diagram

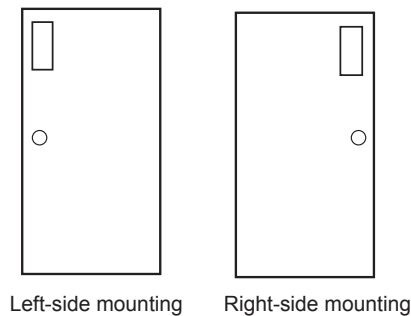

Left-side mounting

Right-side mounting

Listings and Approvals



UL Listed Miscellaneous Fire Door Accessory

MIL-STD 810F (G), Method 509.4 (Salt Fog Test)

MIL-STD 810F (G), Method 506.4 (Driving Rain), Procedure 1



ANSI/BHMA A156.29

Detex Limited Warranty

3 Year Limited Manufacturer's Warranty



Detex Corporation
 302 Detex Drive
 New Braunfels, Texas 78130-3045 USA
 PH. (830) 629-2900
 (800) 729-3839
 FAX (800) 653-3839
<http://www.detex.com>
 USA Sales:
marketing@detex.com
 International Sales:
export@detex.com

Cancer & Reproductive Harm - www.detex.com/prop65

EAX[®] EXIT ALARMS

EAX-411SK

Door Prop Alarm

The EAX-411SK AC powered door prop alarm provides a unique solution to the common security challenge associated with doors that are propped open. Helping to enhance access control systems and provide additional perimeter security, the EAX-411SK provides a custom fit for each opening with its 0 to 60 second adjustable “door open” time. When a door is left open longer than the set time, the alarm will sound. The EAX-411SK will automatically reset when the door is closed.

Specify the EAX-411SK kit which includes the ES-411, finished S1 back box, plug-in transformer and MS-1039S magnetic switch.



Benefits

- Alarm encourages door users to keep door closed
- Localized alarm notifies area personnel of security breach/ door prop condition
- Eliminating door propping helps save on energy costs
- Remote relay allows monitoring of door status from management office or guard station
- Reduces false alarms

Features

- Stand alone device
- Integrates into any access control system
- Kit includes transformer and magnetic door contact
- 90dB alarm easily warns of door prop status
- Adjustable alarm delay time 0 to 60 seconds
- Alarm status relay for remote annunciation (zone monitoring)
- Automatic alarm reset/rearm upon closure of door
- Mounts in a 1 gang box (included in SK Kit)
- Flush mount, aesthetically pleasing

Technical Information

- 12 or 24 VAC/VDC @ 70 mA
- Input - Normally Closed Door Contact
- Output - Normally Closed Door Held Alarm (500mA @ 30VDC)

Riser Diagram

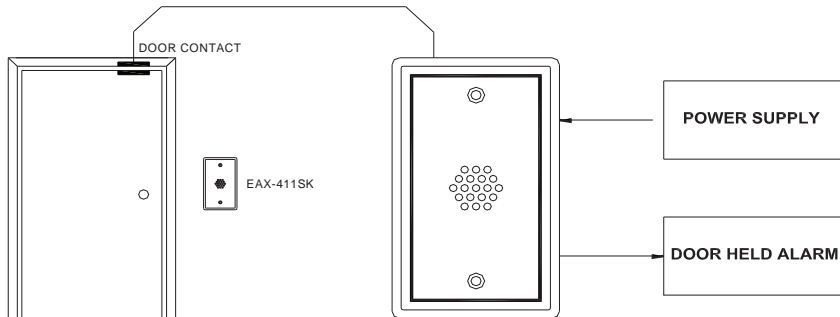

Finishes

- Painted Beige

Dimensions

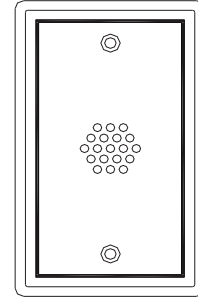

2-3/4" Wide x 4-5/8" High x 2" Deep

Detex Limited Warranty

3 Year Limited Manufacturer's
Warranty

Where Trust is Built™
DETEX®
Life Safety, Security and Security Assurance

Detex Corporation
302 Detex Drive
New Braunfels, Texas 78130-3045 USA
PH. (830) 629-2900
(800) 729-3839
FAX (800) 653-3839
<http://www.detex.com>
USA Sales:
marketing@detex.com
International Sales:
export@detex.com

 Cancer & Reproductive Harm - www.detex.com/prop65

EAX[®] EXIT ALARMS

EAX-4200

Door Management Alarm

The EAX-4200 Series Door Management Alarm offers door prop/door held, intrusion/door forced, and exit alarm detection capabilities to provide complete monitoring of access control points in one easy to use master unit. The DMA may also be used as a stand-alone device. The unit is typically mounted near the monitored door.

Specify the EAX-4200SK kit which includes ES4200-K4, RC65 rim cylinder, S3 finished back box, TP-24 plug-in transformer and MS-1039S mag switch.



Benefits

- Audible warning reduces false door held alarms
- Reduces workload of security personnel
- Aesthetically pleasing design
- Flexible interfacing with electric door locks
- Compatible with all access control systems
- Tamper resistant
- Encourages employees to maintain access control procedures
- Can be used as a stand-alone product
- Easy installation

Features

- Kit packaging provides all required accessories in one box
- Field selectable alarm timing and alarm delay option
- Alarm status relay for remote annunciation
- Automatic alarm reset/rearm upon closure of door
- Mounts in a 3 gang box (included in kit)
- Uses standard rim cylinder
- Visual Status indicator
- Incorporates form C output relays
- Flush mount
- Reset/bypass keyswitch and remote input
- Field selectable: high (103dB) or low (96dB) level sounder

Mechanical Options

- Key switch for alarm/shunt override
- Timer settings are field adjustable

Electrical Options

- Voltage sense input
- 4 separate Form C contacts - 1Amp @ 30VDC

Technical Information

- 12 to 24VAC/VDC @ 250 mA
- 96 and 103dB field selectable

Finishes

- Painted aluminum

Riser Diagram

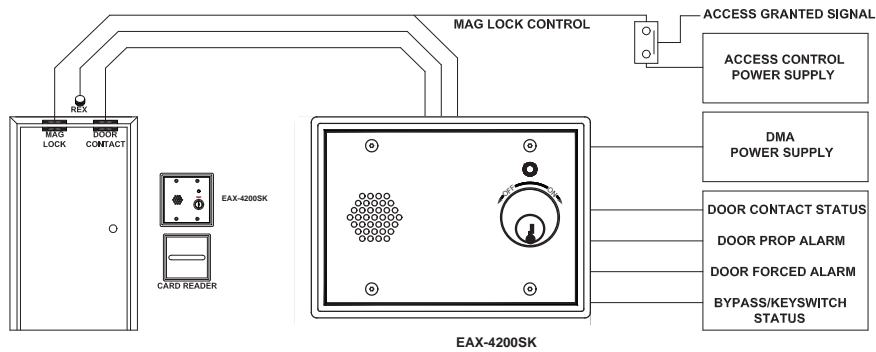

Dimensions

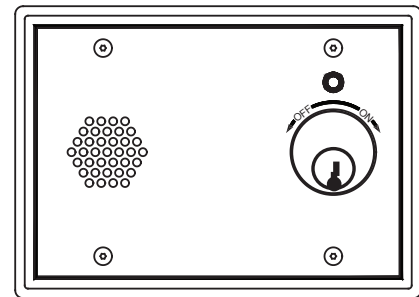

- 6.4" w x 4.5" h x 2.8" d

Detex Limited Warranty

3 Year Limited Manufacturer's Warranty

Where Trust is Built™
DETEx®
Life Safety, Security and Security Assurance

Detex Corporation
302 Detex Drive
New Braunfels, Texas 78130-3045 USA
PH. (830) 629-2900
(800) 729-3839
FAX (800) 653-3839
<http://www.detex.com>
USA Sales:
marketing@detex.com
International Sales:
export@detex.com

 Cancer & Reproductive Harm - www.detex.com/prop65

REMOTE ALARMS

CS940/950F; CS940/950S; CS2940/2950F; CS2940/2950S

The CS900/2900 Series Remote Alarms are designed to sound an alarm when a signal is sent from a door switch, remote relay output, or another alarm. The piercing 100dB alarm will alert management of a security breach even in a noisy environment. When the cause of the alarm has been secured, the remote alarm is automatically silenced.

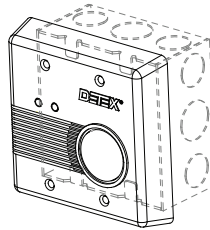

**CS900/2900F Series
Flush Mounted
Remote Alarm**

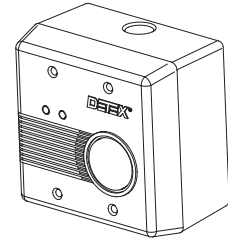

**CS900/2900S Series
Surface Mounted
Remote Alarm**

CS900 Series 9VDC Battery Powered
CS2900 Series External Powered (Plug-in Transformer Included) with 9VDC Battery Backup

Benefits

- No cylinder required - cylinder dummy included
- 100dB alarm sounds when triggered by main alarm, demanding attention
- Silencing the main alarm automatically resets the remote alarm

Features

- Installed in a double switch/outlet box (flush units)
- Red LED lights up when alarm sounds
- Available in gray (CS940/CS2940) or black (CS950/CS2950)
- Battery Backup (2900 Series)
- Flush mount (specify suffix F) or Surface mount (specify suffix S)

Mechanical Options

- SSK4 - Tamper Proof Kit - Adds tamper resistance

Technical Information

- 9VDC Battery (CS900)
- Monitors an open contact
- Remote alarm can be up to 1000 feet from primary alarm with 18 gauge twisted pair wire
- CS2900 includes 120VAC plug-in adapter
- Max current draw - 50mA

Dimensions

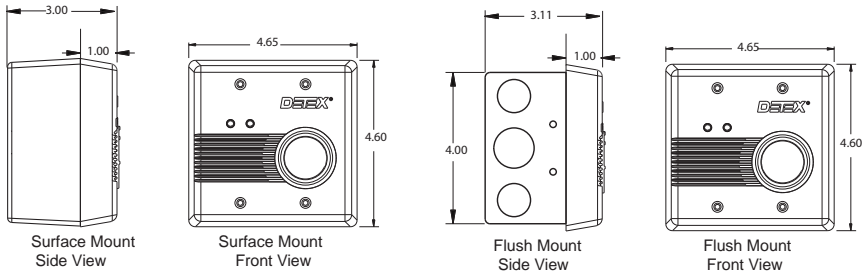

Where Trust is Built™
DETEX®
Life Safety, Security and Security Assurance

Detex Corporation
302 Detex Drive
New Braunfels, Texas 78130-3045 USA
PH. (830) 629-2900
(800) 729-3839
FAX (800) 653-3839
<http://www.detex.com>
USA Sales:
marketing@detex.com
International Sales:
export@detex.com

 Cancer & Reproductive Harm - www.detex.com/prop65

MAGNETIC SWITCH

MS-2049F, MS-2049S, MS-2049SC, MS-2049SI

These magnetic switches are designed primarily to serve as sensing devices to detect the opening of a door or window; to assure that a protected door is securely under surveillance; to serve as a trigger for a wall-mounted Detex Exit Alarm; to signal that a door has been inadvertently left open; and to be used as a direct switch to set off many kinds of audio and visual alarms.



**MS-2049F Flush
Magnetic Switch**

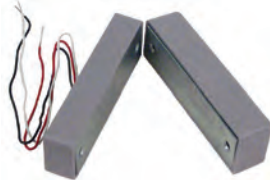

**MS-2049S Surface Mounted
Magnetic Switch**



**MS-2049SC Surface Mounted
Magnetic Switch
with conduit connector for use
with thin-wall conduit**



**MS-2049SI Surface Mounted
Magnetic Switch
for In-Swinging Doors**

Benefits

- Provides assurance that protected doors are under surveillance
- Serves as a trigger for alarms or remote monitors
- UL listed for use on fire rated doors and assemblies

Features

- Tamper protection - mounting screws inaccessible when door closed
- Components potted to protect against shock and moisture
- Easy installation with concealed wiring and color coded leads
- Surface mounted units are housed in a durable high impact ABS thermoplastic, a UL listed material used in the manufacture of telephones, auto bodies, etc.
- Wide range of alarm and signal applications
- Minimizes false signals due to loosely closed doors
- Switch rated for over one million operations under load

Technical Information

- Maximum contact ratings - 24VDC @ .5A
- For use on steel, aluminum or wood doors and frames
- May be mounted on stiles as narrow as 1-3/8"
- Overhead (preferred) or latch-stile mounting available for all models
- Switch - single pole, double throw (SPDT)
- The flush device (MS-2049F) should have the switch contact housed in the door frame and the magnet mortised in the edge of the door
- Wiring leads, 12" long, color coded, concealed

Dimensions (MS-2049F)

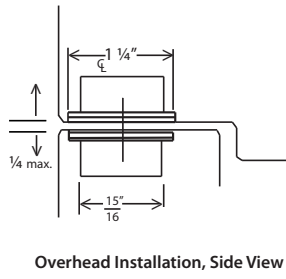
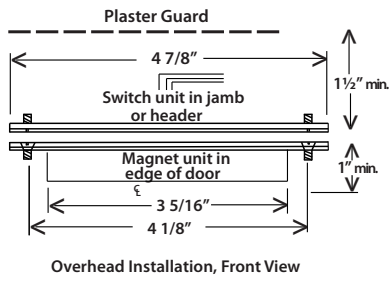

Dimensions (MS-2049S)

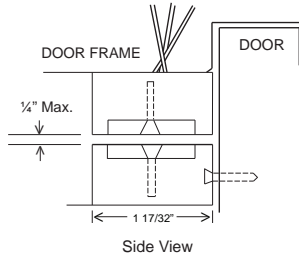
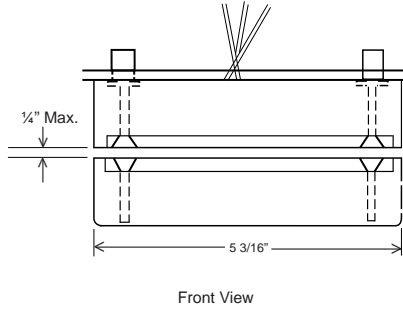

Riser Diagram

Overhead mounting (preferred)

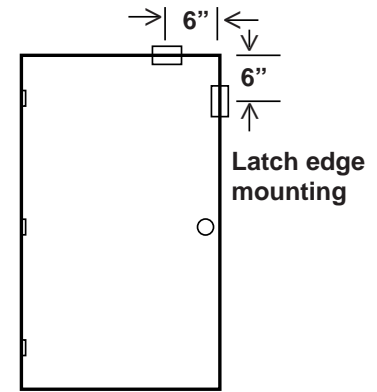

Listings and Approvals



“UL Listed Miscellaneous Fire Door Accessories”
“UL Listed Door Position Switch”

Detex Limited Warranty

3 Year Limited Manufacturers Warranty

Cancer & Reproductive Harm - www.detex.com/prop65

Where Trust is Built™
DETEx®
Life Safety, Security and Security Assurance

Detex Corporation
302 Detex Drive
New Braunfels, Texas 78130-3045 USA
PH. (830) 629-2900
(800) 729-3839
FAX (800) 653-3839
<http://www.detex.com>
USA Sales:
marketing@detex.com
International Sales:
export@detex.com

MAGNETIC SWITCH

MS-1039F, MS-1039S, MS-1059F, MS-1059S

These magnetic switches are designed primarily to serve as sensing devices to detect the opening of a door or window; to assure that a protected door is securely under surveillance; to serve as a trigger for a wall-mounted Detex Exit Alarm; to signal that a door has been inadvertently left open; and to be used as a direct switch to set off many kinds of audio and visual alarms.

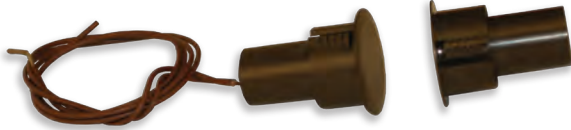

MS-1039F (White) / MS-1059F (Brown)
Flush Magnetic Switch
(MS-1059F Shown)

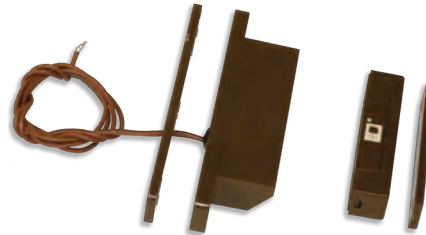

MS-1039S (White) / MS-1059S (Brown)
Surface Mounted
Magnetic Switch
(MS-1059S Shown)

Benefits

- Anti-Tamper Design
- Provides assurance that protected doors are under surveillance
- BMS - Balanced Magnetic Switch provides improved security
- Serves as a trigger for alarms or remote monitors
- Simple Installation

Features

- Polarity selection is non-critical
- Flush switches are self-locking
- Color selection white/brown
- Flush switches are solid, one-piece design with no need for extra donut adapters
- Durable Magnet
- Wide range of alarm and signal applications

Technical Information

- Surface switches have Max. Contact rating 30VDC @ 250mA
- Overhead (preferred) or latch-stile mounting available for all models
- The MS-1039F (Flush mount) should have the switch contact housed in the door frame and the magnet mortised in the edge of the door
- Flush switches have Max. Contact rating 28VDC, 0.5A, 10W
- Switch - single pole, single throw (SPST)
- Normally closed contact
- For use on steel, aluminum or wood doors and frames

Finishes

- MS-1039F/S - White
- MS-1059F/S - Brown

Dimensions (MS-1039F/MS-1059F)

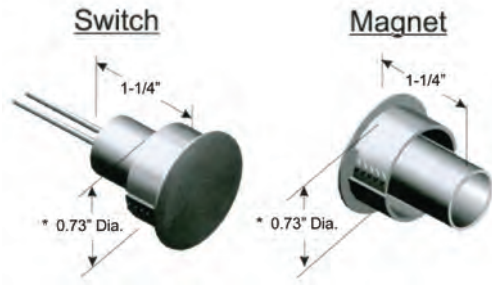

Riser Diagram

Overhead mounting (preferred)

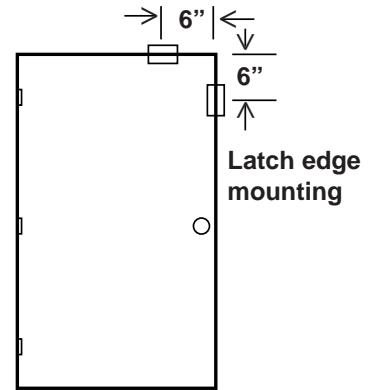

Dimensions (MS-1039S/MS1059S)

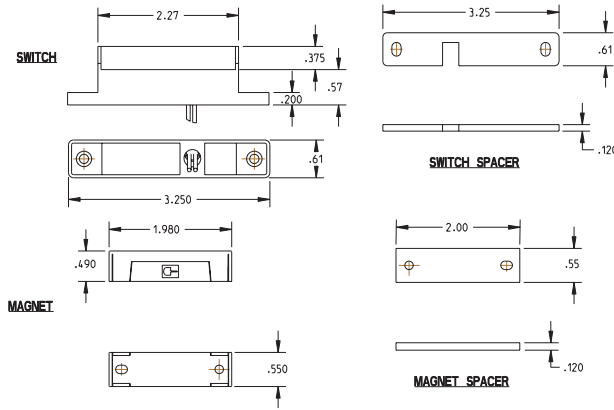

Detex Limited Warranty
3 Years Limited Manufacturers
Warranty



Detex Corporation
302 Detex Drive
New Braunfels, Texas 78130-3045 USA
PH. (830) 629-2900
(800) 729-3839
FAX (800) 653-3839
<http://www.detex.com>
USA Sales:
marketing@detex.com
International Sales:
export@detex.com

Cancer & Reproductive Harm - www.detex.com/prop65