



CLX3300 Series Cylindrical Lever Locksets

Product Catalog

Experience a safer
and more open world

Table of Contents

CLX3300 Series



Overview	3
Certifications	4
Technical Details	5
Trim	6
Functions	7-9
CL33900 Electrified Lock	10-11
Cylinders	12-13
Latches	14
Strikes	15
Options	16
Quick Codes	17
Finishes	18
How to Order	19
How to Specify	20

MicroShield®

ASSA ABLOY Group companies offer MicroShield®, an anti-microbial coating for door hardware. MicroShield uses proven silver ion-based technology from Agion®, a leading provider of antimicrobial solutions, to stem the spread of bacteria and other microbes.

MicroShield® is a trademark of ASSA ABLOY Access and Egress Hardware Group, Inc.

MicroShield® Coating

- Revolutionary finish coating available on all Corbin Russwin product lines, utilizes a silver-based antimicrobial compound from Agion Technologies
- As an integral part of the finish coating, MicroShield lasts for the life of the hardware
- MicroShield coating permanently suppresses the growth of bacteria, algae, fungus, mold and mildew. It is effective against a broad spectrum of bacteria.
- Non-toxic and completely safe. The Agion antimicrobial compound is EPA and NSF approved and FDA listed for use in medical and food preparation equipment.
- Applications: Anywhere there is need for a clean environment (hospitals, laboratories, schools, medical centers, daycare, food processing etc.)



The Agion antimicrobial is not intended as a substitute for good hygiene. Coated products must still be cleaned to ensure the surfaces will be free of destructive microbes. ASSA ABLOY makes no representations or warranties, express or implied, as to the efficacy of the Agion antimicrobial. A copy of the Agion warranty is available upon request. Agion is a registered trademark of Agion Technologies, Inc., Wakefield, MA, USA.

The CLX3300 Series ANSI/BHMA Grade 1 cylindrical lock has the strength to secure high-traffic openings with design options to complement any decor. Manufactured of the highest-quality materials to provide durability, strength, and reliability, it is also available in a vast array of finishes and a variety of decorative levers, so you'll never have to sacrifice style for strength.

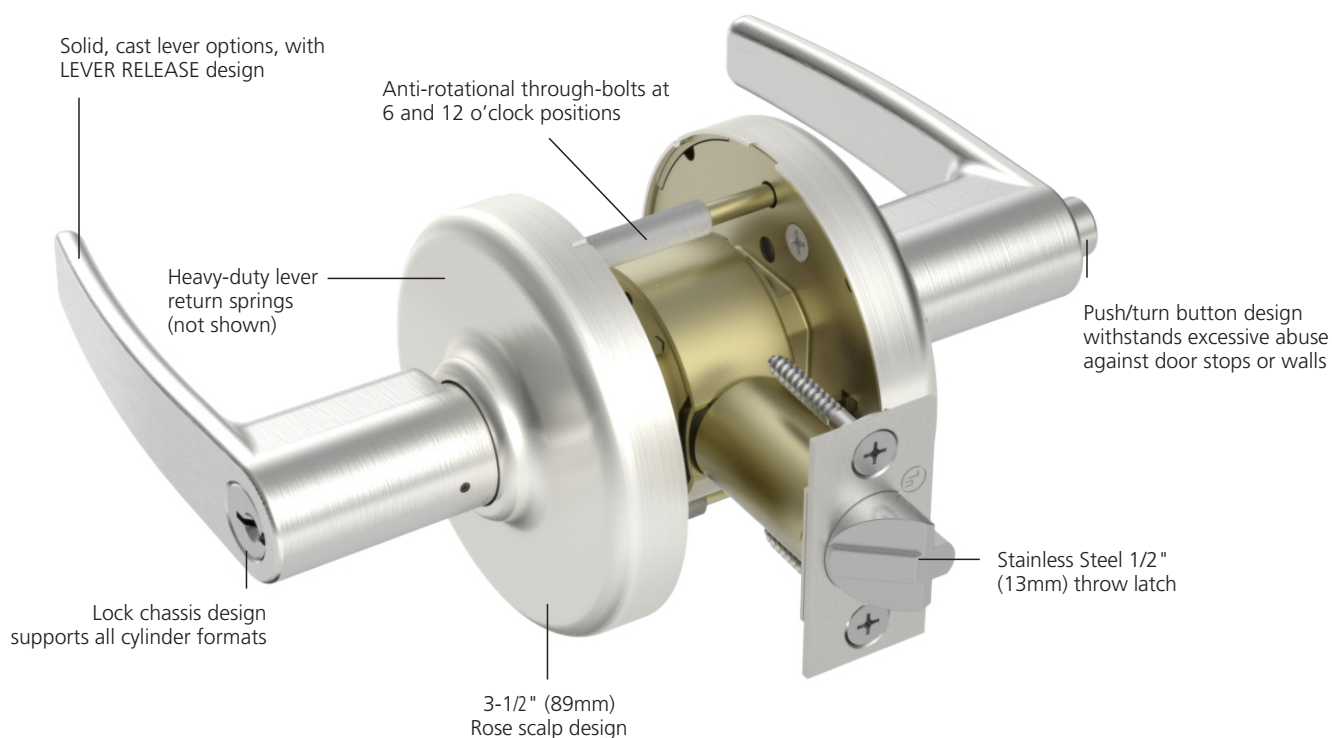

Applications

- Heavy duty commercial and institutional interior and exterior doors
- Offices
- Schools/Universities
- Hospitals
- Manufacturing facilities

Certifications

CLX3300 Series

Certification/Compliance

ANSI/BHMA	Certified ANSI/BHMA A156.2 (2017) Series 4000 — Grade 1 Certified ANSI/BHMA A156.41
UL/cUL	UL/cUL listed to US and Canadian safety standards for 3 hour doors up to 4' x 10' (double doors require 41- option)
NFPA 80	Conforms for life safety and property protection, Standard for Fire Doors and Other Opening Protectives
Positive Pressure	Meets ANSI/UL 10C, Positive Pressure Fire Test of Door Assemblies
ADA	All levers conform to ADA clear opening width requirements of ANSI A117.1
California State Reference Code (Formerly Title 19, California State Fire Marshal Standard)	All levers with returns comply; levers return to within 1/2" (13mm) of door face
Windstorm/Hurricane	All individual components of a total door opening are required to comply with each code. Refer to the Corbin Russwin Website (www.corbinrusswin.com) for specific code compliance listings for both the lock hardware and other door components.

Any retrofit or other field modification to a fire rated opening can potentially impact the fire rating of the opening, and Corbin Russwin makes no representations or warranties concerning what such impact may be in any specific situation. When retrofitting any portion of an existing fire rated opening, or specifying and installing a new fire-rated opening, please consult with a code specialist or local code official (Authority Having Jurisdiction) to ensure compliance with all applicable codes and ratings.

Windstorm Certifications: Florida Building Codes & UL Listings

Corbin Russwin products meet building codes that require hurricane and windstorm certifications, including some of the most stringent building codes as specified in the Florida Building Code, Miami Dade Code and the International Building Code. Listed below are certifications and standards met by the CLX3300 Series lock.

Florida Building Code: FL3067

UL Certification Directory: ZHEM.R21836 – Latching Hardware

ANSI/SDI A250.13 (2014)	"Testing and Rating of Severe Windstorm Resistant Components for Swinging Door Assemblies"
ASTM E330 (2002)	"Standard Test Method for Structural Performance of Exterior Windows, Doors, Skylights and Curtain Walls by Uniform Static Air Pressure Difference" *
ASTM E1886 (2005)	"Standard Test Method for Performance of Exterior Windows, Curtain Walls, Doors, and Impact Protective Systems Impacted by Missile(s) and Exposed to Cyclic Pressure Differentials" *
ASTM E1996 (2009)	"Standard Specification for Performance of Exterior Windows, Curtain Walls, Doors and Impact Protective Systems Impacted by Windborne Debris in Hurricanes" *
(TAS) 201 (1994)	"Impact Test Procedures" *
(TAS) 202 (1994)	"Standard Test Method for Structural Performance of Exterior Windows, Doors, Skylights and Curtain Walls by Uniform Static Air Pressure Difference" *
(TAS) 203 (1994)	"Criteria for Testing Products Subject to Cyclic Wind Pressure Loading" *

* Published in the 7th Edition (2020), "Florida Building Code" (FBC), State Product Approval Number FL3067

Door Prep	ANSI/BHMA A156.115
Door Thickness	1-3/4" (44mm) - 2" (51mm) standard 1-3/8" (35mm) thick door, specify Quick Code D138 for Adapter plates Over 2" (51mm) up to 2-1/4" (57mm), specify Quick Code D214
Minimum Stile	4-1/2" (114mm)
Handing	Non-handed
Backset	2-3/4" (70mm) backset w/ 1-1/8" front (standard) 2-3/8" (60mm) backset w/ 1" wide front (specify Quick Code B238) 3-3/4" (95mm) backset w/ 1-1/8" front (specify Quick Code B334) 5" (127mm) backset w/ 1-1/8" front (specify Quick Code B500)
Latchbolt	Stainless steel, 1/2" (13mm) throw Optional: Brass, 3/4" (19mm) throw deadlocking fire latch for pair of doors (specify Quick Code M16)
Front	Wrought brass, bronze, or stainless steel Optional: rounded corners (specify Quick Code M13) 2-1/4" x 1-1/8" (57mm x 29mm) standard for 2-3/4" (70mm), 3-3/4" (95mm) and 5" (127mm) backset 2-1/4" x 1" (57mm x 25mm) standard for 2-3/8" (60mm) backset Accommodates flat doors and doors beveled 1/8" in 2" (3mm in 51mm)
Strike	Wrought brass or stainless steel ANSI curved lip standard, 4-7/8" (124mm) x 1-1/4" (32mm) x 1-1/4" (32mm) lip to center Optional strikes, lip lengths and ANSI wrought strike box available; see page 15
Cylinder	Brass, 6-pin L4 keyway, 0-bitted standard
Keys	Two nickel silver change keys per lock standard
Masterkeying	Can be master keyed or grand master keyed Construction key systems available
Lead Lining	Lead provided between lockbody and spring housing (specify Quick Code M28)
Tactile Levers	Knurling (etching) or abrasive coating (surface tape) applied to backside of levers (see Quick Codes page 17)
Finishes	See page 18
Warranty	Ten-year limited

Strength & Durability

- Exceeds 3,100 in-lb abusive locked lever torque with no entry while maintaining egress (2.6 times ANSI/BHMA A156.2 requirements)
- Exceeds 1,600 lbs offset lever pull with no entry for protection against attacks (8 times ANSI/BHMA A156.2 requirements)
- Latch retraction with 100lb preload (2 times ANSI/BHMA A156.2) while maintaining ANSI/BHMA requirements for operation in warped doors
- No access with minimum 100 vertical impacts for protection against vandalism attempts (20 times ANSI/BHMA A156.2 requirements)
- Independent return springs allow lock to exceed ANSI/BHMA A156.2 Grade 1 cycle requirements without lever sag
- Innovative push/turn button design to withstand excessive abuse against door stops or walls.

Flexibility

- Lock chassis design supports all cylinder formats allowing flexibility for from fixed core to interchangeable core cylinders.
- High Security and security key systems available (Access 3, Pyramid, etc.)
- Patent pending adjustable push/turn button for easy door thickness adjustment.
- Lever Release™ freewheeling levers standard for vandal resistance; rigid lever optional.

Broad Offering

- Available with 26 mechanical functions
- 14 finishes and MicroShield options
- Multiple lever options including decorative designs

Trim

CLX3300 Series

Levers - Solid Cast Zinc

Armstrong AZ

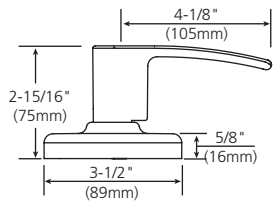

Newport* NZ

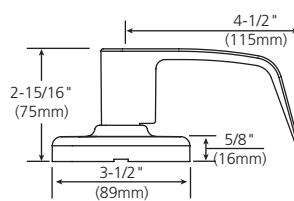

Princeton* PZ

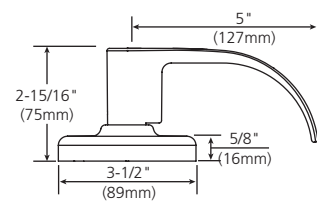

Decorative Levers

102

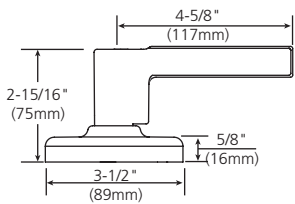

106

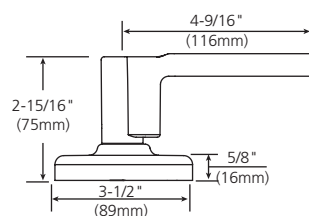

123*

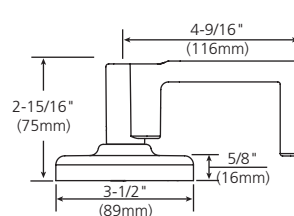

124*

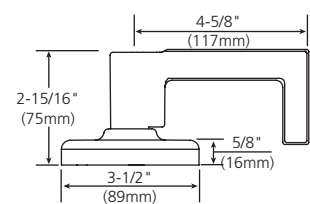

*Lever with return to within 1/2" of door face.

Rose Wrought Brass

D

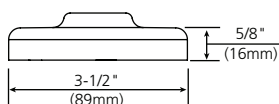

Functions

CLX3300 Series

Outside	Inside	Series/Function	Type	ANSI No.	Function Description
		CLX3310	Passage or Closet	F75	<ul style="list-style-type: none"> Latchbolt by lever either side Both levers always free
		CLX3320	Privacy, Bedroom or Bathroom	F76A	<ul style="list-style-type: none"> Outside lever locked by push button (lever handle is freewheeling in locked position) Outside lever unlocked by emergency release tool outside, by rotating inside lever or by closing door Inside lever always free
		CLX3320H	Hospital Privacy	—	<ul style="list-style-type: none"> Outside lever locked by inside push button (lever handle is freewheeling in locked position) Outside lever unlocked by simultaneously depressing outside pushbutton while rotating lever Rotating inside lever or closing door also unlocks outside lever Outside lever handle is freewheeling when locked
		CLX3320TO	Time Out Lock	—	<ul style="list-style-type: none"> Latchbolt by lever either side (passage) unless push button depressed and held by caretaker (detention side becomes freewheeling). Lock returns to passage mode upon release of push button. Push button automatically releases when caretaker releases push button Both levers always free
		CLX3329	Hotel or Motel	F93	<ul style="list-style-type: none"> Deadlocking latchbolt by lever inside or by key outside Push button shuts out all keys except emergency key, and projects occupancy indicator in face of cylinder (lever handle is freewheeling in locked position) Push button released by turning inside lever or by closing door* Outside lever always locked Inside lever always free Not available with other manufacturers keyways
		CLX3332	Institutional or Utility	F87	<ul style="list-style-type: none"> Deadlocking latchbolt by key either side (lever handles are freewheeling in locked position) Should be used only in office or room with multiple entries Keyed alike unless otherwise specified
		CLX3340	Patio or Privacy	F77A	<ul style="list-style-type: none"> Deadlocking latchbolt by lever Outside lever locked by push button (lever handle is freewheeling in locked position) Outside lever unlocked by operating inside lever or closing door Inside lever always free Should not be used in rooms that have no other entrance
		CLX3340NT	Exit Latch	F89	<ul style="list-style-type: none"> Deadlocking latchbolt by lever inside Outside lever always locked (lever handle is freewheeling in locked position) Inside lever always free
		CLX3351	Entrance or Office	F109	<ul style="list-style-type: none"> Deadlocking latchbolt by lever either side, except when turn button locks outside lever. Pushing turn button in locks outside lever, requiring use of key outside to unlock. (Lever handle is freewheeling in locked position) Turning inside lever unlocks outside lever Pushing in and turning button locks outside lever, requiring key at all times. Turning inside lever does not unlock outside lever until button is manually turned to unlocked position. Inside lever always free



Indicates optional interchangeable core available; see Quick Codes, page 16.

Indicates freewheeling lever in locked position. Specify Quick Code M200 for rigid lever in locked position.

*Unless push button has been fixed in locked position by spanner key (furnished). When push button is fixed by spanner key, lock is operable only by emergency key or by display key.

Functions

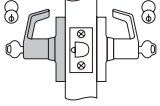
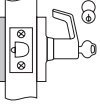
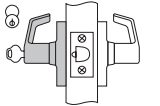
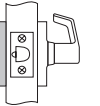
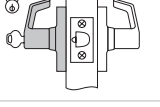
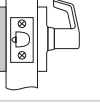
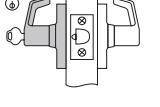
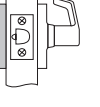
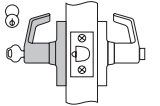
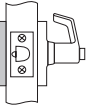
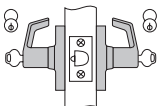
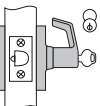
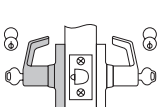
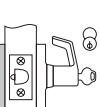
CLX3300 Series

Outside	Inside	Series/Function	Type	ANSI No.	Function Description
		CLX3352	Classroom Intruder	F110	<ul style="list-style-type: none"> Deadlocking latchbolt by inside lever or outside lever except when key inside or outside locks outside lever (lever handle is freewheeling in the locked position) Outside lever is locked and unlocked by turning the key in the inside or outside lever Inside lever always free
		CLX3355	Classroom	F84	<ul style="list-style-type: none"> Deadlocking latchbolt by lever either side, except when key outside locks outside lever (lever handle is freewheeling in locked position) Outside lever unlocked by key outside Inside lever always free
		CLX3357	Storeroom or Closet	F86	<ul style="list-style-type: none"> Deadlocking latchbolt by key in outside lever or by rotating inside lever (lever handle is freewheeling in locked position) Inside lever always free
		CLX3359	Barrier Free Storeroom or Public Restroom	—	<ul style="list-style-type: none"> Deadlocking latchbolt by inside lever Key outside unlocks outside lever to retract latchbolt Key is retained in unlock mode When key is removed outside lever is locked (lever handle is freewheeling in locked position) Inside lever always free
		CLX3361	Entry or Office	F82A	<ul style="list-style-type: none"> Deadlocking latchbolt by lever either side, except when push button locks outside lever Push button released by turning inside lever or by key in outside lever (lever handle is freewheeling in locked position) Closing door does not release push button Inside lever always free
		CLX3362	Communicating	F80	<ul style="list-style-type: none"> Deadlocking latchbolt by lever either side, except when key in either lever locks and unlocks the lever independently of the other (lever handle is freewheeling in locked position) Keyed alike unless otherwise specified Should be used only in office or room with multiple entries
		CLX3372	Apartment, Exit or Public Toilet	F88	<ul style="list-style-type: none"> Deadlocking latchbolt by lever either side, except when key inside locks outside lever (lever handle is freewheeling in locked position) Key outside retracts latchbolt Key inside unlocks outside lever Inside lever always free Keyed alike unless otherwise specified
		CLX3375	Corridor/Dormitory Lock	F90	<ul style="list-style-type: none"> Deadlocking latchbolt by lever either side except when pushbutton or key locks outside lever Pushbutton released by turning inside lever or by closing door Depressed pushbutton indicates door is locked When outside lever is locked by key, it can only be unlocked by key Inside lever always free Outside lever rigid when locked

 Indicates optional interchangeable core available; see Quick Codes, page 16.

 Indicates freewheeling lever in locked position. Specify Quick Code M200 for rigid lever in locked position.

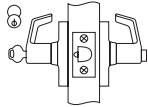
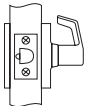
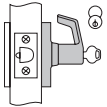
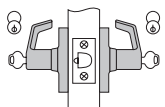
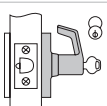
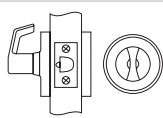
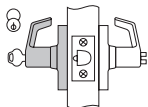
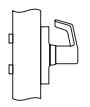
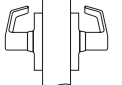
Outside	Inside	Series/Function	Type	ANSI No.	Function Description
		CLX3376	Corridor/ Dormitory Lock	F90 (Modified)	<ul style="list-style-type: none"> Deadlocking latchbolt by lever either side except when pushbutton or key locks outside lever Pushbutton released by turning inside lever or by closing door Depressed pushbutton indicates door is locked When outside lever is locked by push button or key, it can be unlocked by key, turning inside lever or closing door Inside lever always free Outside lever rigid when locked
		CLX3380	Passage Lever x Blank Plate	F111	<ul style="list-style-type: none"> Deadlocking latchbolt by lever Lever on one side; blank plate on other side Lever always free For single or double communicating doors
		CLX3381	Classroom x Blank Plate	F113	<ul style="list-style-type: none"> Deadlocking latchbolt by lever, except when lever is locked by key (lever handle is freewheeling in locked position) Lever on one side; blank plate on other side Key unlocks lever
		CLX3382	Store Door Lock	F91	<ul style="list-style-type: none"> Deadlocking latchbolt by lever either side, except when both levers are locked by key from either side (lever handle is freewheeling in locked position) Keyed alike unless otherwise specified Should be used only in office or room with multiple entries
		CLX3383	Storeroom x Blank Plate	F112	<ul style="list-style-type: none"> Deadlocking latchbolt by key in lever (lever handle is freewheeling in locked position) Lever always locked Lever on one side; blank plate on other side
		CLX3390	Passage Lever x Turnpiece	—	<ul style="list-style-type: none"> Deadlocking latchbolt by lever or by turnpiece Lever on one side; turnpiece on other side Lever and turnpiece always free
		CLX3393	Service Station	F92	<ul style="list-style-type: none"> Deadlocking latchbolt by lever Outside lever locked by slotted push button (lever handle is freewheeling in locked position) When slotted push button is pushed in and turned, outside lever becomes freewheeling and deadlocking latch is activated. Outside lever is unlocked by using key or by rotating inside lever, when slotted push button returned to original position. Inside lever always free
		CLX3350	Half Dummy Trim	—	<ul style="list-style-type: none"> Lever acts as pull only; no operation Lever is rigid
		CLX3370	Full Dummy Trim	—	<ul style="list-style-type: none"> Levers act as pulls only; no operation Levers are rigid

 Indicates optional interchangeable core available; see Quick Codes, page 16.

 Indicates freewheeling lever in locked position. Specify Quick Code M200 for rigid lever in locked position.

CL33900 Electrified Lock

CLX3300 Series

The CL33900 electrified lock provides remote locking and unlocking, utilizing the CL3300 Series cylindrical lock. It is ideal for door control where increased security is necessary at all times, while meeting life safety codes.



Features

Door Prep	ANSI/BHMA A156.115
Door Thickness	1-3/4" (44mm) - 2" (51mm) standard Over 2" (51mm) up to 2-1/4" (57mm), specify Quick Code D214
Handing	Non-handed
Backset	2-3/4" (70mm) backset w/ 1-1/8" front (standard) 3-3/4" (95mm) backset w/ 1-1/8" front (specify Quick Code B334) 5" (127mm) backset w/ 1-1/8" front (specify Quick Code B500)
Latchbolt	Stainless steel, 1/2" (13mm) throw Optional: Brass, 3/4" (19mm) throw deadlocking fire latch for pair of doors (specify Quick Code M16)
Front	Wrought brass, bronze, or stainless steel 2-1/4" x 1-1/8" (57mm x 29mm) standard for 2-3/4" (70mm) 3-3/4" (95mm) and 5" (127mm) backset. Accommodates flat doors and doors beveled 1/8" in 2" (3mm in 51mm)
Strike	Wrought brass or stainless steel ANSI curved lip standard, 4-7/8" (124mm) x 1-1/4" (32mm) x 1-1/4" (32mm) lip to center Optional strikes, lip lengths and ANSI wrought strike box available; see page 15
Cylinder	Brass, 6-pin L4 keyway, 0-bitted standard, refer to the CL3300 catalog section for cylinder details and options available for the CL33900
Keys	Two nickel silver standard.
Masterkeying	Can be master keyed or grand master keyed Construction key systems available
Voltage	Available with 12VAC/DC (specify Quick Code 12AD) or 24VAC/DC (specify Quick Code 24AD)
Electrical Specifications	250mA @ 12VAC/VDC 150mA @ 24VAC/VDC Continuous duty solenoid.
Electrical Options	Request to Exit (M92)
Finishes	See page 18
Warranty	Two-year limited.

Functions

Outside	Inside	Series/Function	Function Description
		CL33903	Fail Safe <ul style="list-style-type: none"> Deadlocking latchbolt by lever either side except when power on locks outside lever Power off/unlocks outside lever Inside lever always free Latchbolt retracted by key when locked electrically
		CL33905	Fail Secure <ul style="list-style-type: none"> Deadlocking latchbolt by lever either side except when power off locks outside lever Power on/unlocks outside lever Inside lever always free Latchbolt retracted by key when power is off

CL33900 Electrified Lock

CLX3300 Series

Requirements for Electrical and Data Transfer

To answer the demand for "smart" electronic access control and locking solutions that require fast, easy, and cost-effective installation, ASSA ABLOY Group brands use the ElectroLynx® standardized plug-in connectors and color-coded wiring system.

With *ElectroLynx*, doorway components come pre-wired for easy hookup to the power source. Key to the system is the transfer device hinge that carries power from the frame to the locking hardware.

Features of ElectroLynx:

- Makes it easy to bring power to the locking hardware
- Wires have connectors that snap together, like plugging a telephone into a jack

To connect a CL33900 series electrified cylindrical lock to the electronic access control system, the following items are required:

- CL33900 series electrified cylindrical lock
- ASSA ABLOY Door Group pre-wired door, or *ElectroLynx* retrofit cable (order from McKinney)
- Electronic transfer device (*ElectroLynx* electronic transfer hinge or Electrical Power Transfer with standard hinge, from McKinney)
- *ElectroLynx* cable from the hinge to above the ceiling (order from McKinney)

Information regarding cable selection, hinge requirements and order strings can be found in the McKinney Transfer Device Solutions catalog. Consult 800-810-WIRE (9473) with questions on application specifications and requirements.

The McKinney QC8 *ElectroLynx* Hinge is recommended for the CL33903 function, the CL33905 function and the M92 (REX) option.

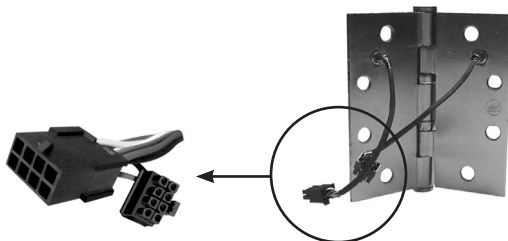

BPS Power Supply

Power supplies are designed to provide reliable filtered and regulated power for long life to a variety of electrified hardware components. All modular power supplies are voltage specific and are designed to meet UL 1481 Standards.

Features

- Fire panel emergency release input
- PC Board mounted system LED indicator
- Voltage specific 12 or 24VDC
- Regulated and filtered with input and output protection
- Battery charging is provided from a separate output terminal

Model	Input	Output
BPS-12-1	115VAC @ 50/60 Hz	1 Amp @ 12VDC
BPS-12-3		3 Amp @ 12VDC
BPS-24-1	115VAC @ 50/60 Hz	1 Amp @ 24VDC
BPS-24-2		2 Amp @ 24VDC



Cylinders

CLX3300 Series

Corbin Russwin Cylinders

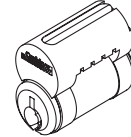
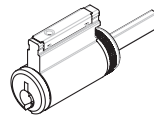

Security Type	Pins	Standard Cylinder	Interchangeable Core
Conventional	6-Pin	CR2000-034 (standard)	8000
	7-Pin	CR2000-034-7	8000-7
Hotel	6-Pin	CR2001-034A	8001-034A
	7-Pin	CR2001-034A-7	8001-034A-7
Security	6-Pin	CR2010-034	8010
Pyramid - High Security	7-Pin	CR2020-034	8020
Pyramid - Security	7-Pin	CR2027-034	8027
Access 3® - Patented (AP)	6-Pin	CR2500-034	8500
Access 3® - Security (AS)	6-Pin	CR2600-034	8600
Access 3® - High Security (AHS)	6-Pin	CR2700-034	8700
Access 3® (AP) - Hotel Function	6-Pin	CR2501-034A	N/A
Access 3® (AS) - Hotel Function	6-Pin	CR2601-034A	N/A
Access 3® (AHS) - Hotel Function	6-Pin	CR2701-034A	N/A

Plug diameter for standard cylinders is .509, .510 for Access 3®, .552 for security cylinders and .496 for Pyramid cylinders.

Cylinders are brass and come with 2 nickel silver keys.

Finishes for all cylinders and cores include 606 or 626.

To order cylinders separately, specify Part No. x Keyway x Finish (e.g., CR2000-034 x L4 x 626).

Cylinders with Competitive Keyways*

Competitive Keyway	Number
Schlage® C (0-bitted)	CR2400-034-C
Schlage® C (keyed random)	CR2400-034-C-KR
SARGENT® LA (0-bitted)	CR2400-034-LA

*All cylinders are 6-pin.

Levers That Accept Competitive Interchangeable Core Cylinders*

Cylinder Type	Quick Code	Tailpiece Pack Only
SFIC 6 or 7-pin (all designs)	M08 Tailpiece included	863F078
Schlage® 6-pin LFIC (AZ, NZ, PZ only)	M69 Tailpiece included	862F472
Yale® 6-pin LFIC (AZ, NZ, PZ only)	YRC Tailpiece included	862F402

*Core not included.

Adapters Required to Accept Competitive Cylinders*

Competitive Cylinder	Quick Code	Tailpiece Pack Only
Schlage® 6-pin fixed core Conventional (21-002, 23-001, 23-013) or Primus® (20-548, 20-550, 20-748, 20-750)	M06 Tailpiece included	863F038
SARGENT® 6-pin fixed core C10-1	M09 Tailpiece and special lever included	862F978
Yale® 6-pin fixed core 1803-46L	YC Tailpiece included	862F998
Yale® 7-pin fixed core 1803A-46L	YC7 Tailpiece included	863F018

*Cylinder not included.

Tailpiece part numbers shown for 1-3/8" to 2" thick doors. See CLX3300 parts manual for other applications.

Latches

CLX3300 Series

Latches

To order optional latch with lockset, see Backset Quick Codes, page 16.

To order latch separately, specify Part No. x Finish (e.g., 867F20 x 626).

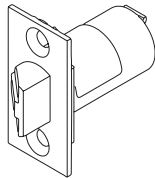
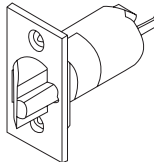
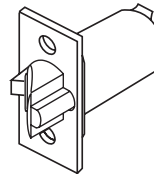
Backset and Front Description	Plain For CLX3310, CLX3320, CLX3320H, CLX3320TO	Deadlocking	3/4" (19mm) Throw Deadlocking Fire Latch for Pair of Doors
2-3/4" (70mm) Backset			
Square corner front, 2-1/4" (57mm) x 1-1/8" (29mm) (standard)	867F20	867F21	601F69 605, 606 and 626 finishes available
Rounded corner front, 2-1/4" (57mm) x 1-1/8" (29mm)	867F26	867F27	Not available
2-3/8" (60mm) Backset			
Square corner front, 2-1/4" (57mm) x 1" (25mm) (standard with B238 option)	599F91	599F92	Not available
Rounded corner front, 2-1/4" (57mm) x 1" (25mm)	599F94	599F95	Not available
Square corner front, 2-1/4" (57mm) x 1-1/8" (29mm)	599F97	599F98	Not available
Rounded corner front, 2-1/4" (57mm) x 1-1/8" (29mm)	600F00	600F01	Not available
3-3/4" (95mm) Backset			
Square corner front, 2-1/4" (57mm) x 1-1/8" (29mm)	867F22	867F23	Not available
Rounded corner front, 2-1/4" (57mm) x 1-1/8" (29mm)	867F28	867F29	Not available
5" (127mm) Backset			
Square corner front, 2-1/4" (57mm) x 1-1/8" (29mm)	867F24	867F25	Not available
Rounded corner front, 2-1/4" (57mm) x 1-1/8" (29mm)	867F30	867F31	Not available
			

Strikes

ANSI Curved Lip (standard)

Brass or stainless steel.

4-7/8" (124mm) x 1-1/4" (32mm) x 1-1/4" (32mm) lip to center.

Optional lip lengths:

1" (25mm), 1-1/8" (29mm), 1-3/8" (35mm), 1-1/2" (38mm), 1-3/4" (44mm), 2" (51mm), 2-1/4" (57mm), 2-1/2" (64mm), 2-3/4" (70mm), 3" (76mm).

To order with lockset, see Quick Codes below.

To order separately, specify 217L13 x Lip Length x Finish.

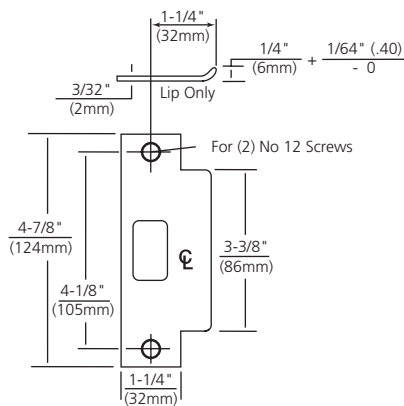

Curved Lip "T" Strike

Brass.

2-3/4" (70mm) x 1-1/8" (29mm) x 1-1/4" (32mm) lip to center.

Optional lip lengths: 1" (25mm), 1-1/8" (29mm), 1-3/8" (35mm), 1-1/2" (38mm), 1-3/4" (44mm), 2" (51mm), 2-1/4" (57mm), 2-1/2" (64mm), 2-3/4" (70mm), 3" (76mm).

To order with lockset, see Quick Codes below.

To order separately, specify 586L19 x Lip Length x Finish.

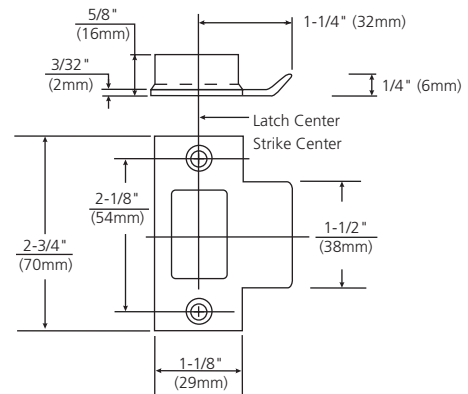

Full Lip Strike

Brass.

2- 3/4" (70mm) x full lip x 1-1/8" (29mm) lip to center.

No optional lip lengths.

To order with lockset, see Quick Codes below.

To order separately, specify 607F76.

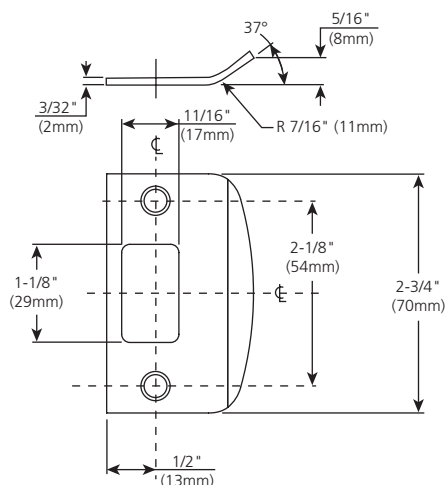

ANSI Wrought Strike Box

Used with ANSI 4-7/8" (124mm) strike .

To order with lockset, specify Quick Code M17.

To order separately, specify 120F768.

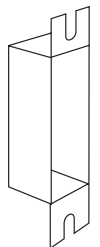

Strikes

ANSI Lip to Center	ANSI Curved Lip Specify	T-Strike Curved Lip Box Specify	Full Lip Specify
1" (25mm)	SA100	SC100	
1-1/8" (29mm)	SA118	SC118	SF118
1-1/4" (32mm)	SA114 (standard)	SC114	
1-3/8" (35mm)	SA138	SC138	
1-1/2" (38mm)	SA112	SC112	
1-3/4" (44mm)	SA134	SC134	
2" (51mm)	SA200	SC200	
2-1/4" (57mm)	SA214	SC214	
2-1/2" (64mm)	SA212	SC212	
2-3/4" (70mm)	SA234	SC234	
3" (76mm)	SA300	SC300	

Options

CLX3300 Series

Cylinder and Keying

Description	Specify
Conventional 6-pin	(standard)
Conventional 7-pin	7P
Less Cylinder(s) ²	LC
LFIC	
LFIC 6-pin	C6
LFIC 6-pin Less Core ¹	CL6
LFIC 6-Pin Disposable Core ¹	CT6D
LFIC 6-pin with Temporary Construction Core (Red)	CT6R
LFIC 6-pin with Temporary Construction Core (Blue)	CT6B
LFIC 6-pin with Temporary Construction Core (Green)	CT6G
LFIC 7-pin	C7
LFIC 7-pin Less Core ¹	CL7
LFIC 7-pin with Temporary Construction Core (Red)	CT7R
LFIC 7-pin with Temporary Construction Core (Blue)	CT7B
LFIC 7-pin with Temporary Construction Core (Green)	CT7G
LFIC 7-Pin Disposable Core ¹	CT7D
SFIC (all lever designs)	
SFIC 6- or 7-pin Disposable Core	CTSD
Security	
Security ¹	HS
Security LFIC ¹	CHS
Access 3[®]	
Access 3 Patented Fixed Core	AP
Access 3 Security Fixed Core	AS
Access 3 High Security Fixed Core	AHS
Access 3 Patented LFIC ¹	ACP
Access 3 Security LFIC ¹	ACS
Access 3 High Security LFIC ¹	ACHS

Pyramid

1. Not available in CLX3329 function
2. CLX3329 not available less cylinder

Door Thickness

Door Thickness	Specify
1-3/4" (44mm) - 2" (51mm)	(standard)
1-3/8" (35mm) Adapter plates	D138*
Over 2" (51mm) - 2-1/4" (57mm)	D214

*Lock provided with adapter (spacer) plates. Supplied with 2-3/8" backset latch with 1" front unless B234 specified.

Description	Specify
Pyramid Security Fixed Core ¹	PS
Pyramid High Security Fixed Core ¹	PHS
Pyramid Security LFIC ¹	PCS
Pyramid High Security LFIC ¹	PCHS
Pyramid LFIC Less Core ¹	CLP
Pyramid with Temporary Construction Core ¹	CTP
Pyramid Disposable Core ¹	CTPD
Keying and Keys	
0-bitted with 2 blank keys	(standard)
Keyed Random	KR
Construction Master Keyed	CMK
2 keys per lock	(standard)
More than 2 keys	KY# (e.g., KY6)
Visual Key Control (VKC)	
No bitting or keyset stamping on keys	VKC0
Keys only	VKC1
Cylinders and keys (not for AS, AHS, ACS, ACHS, HS, CHS, PHS or PCHS)	VKC2
Cylinders only (not for AS, AHS, HS, ACS, ACHS, CHS, PHS or PCHS)	VKC3
Concealed Key Control (CKC)	
CKC cylinders with VKC keys	CKC2
CKC cylinders only (not for AS, AHS, ACS, ACHS, PHS, PCHS)	CKC3
Schlage [®] C keyway cylinder (0-Bitted or KR) ¹	C
SARGENT [®] LA keyway cylinder (0-Bitted) ¹	LA

Backset

Description	Specify
2-3/4" (70mm)	B234 (standard)
2-3/8" (60mm)	D238
3-3/4" (95mm)	B334
5" (127mm)	B500

Miscellaneous Options

Description	Specify
Spanner head screws	M02
Torx® head screws	M04
Less cylinder, with tailpiece for Schlage® 6-pin fixed core cylinder (all designs)	M06
Lever to accept 6 or 7-pin SFIC (all designs)	M08
Lever to accept SARGENT® 6-pin fixed core cylinder (all designs)	M09
Rounded corners on latch front	M13
1" latch front, rounded corners (2-3/8" backset only)	M15
3/4" (19mm) throw fire latch	M16
ANSI wrought strike box	M17
Knurling outside and inside (AZ, NZ, PZ only)	M20
Knurling outside only (AZ, NZ, PZ only)	M21
Knurling inside only (AZ, NZ, PZ only)	M22
Abrasive coat outside and inside (AZ, NZ, PZ only)	M23
Abrasive coat inside only (AZ, NZ, PZ only)	M24
Abrasive coat outside only (AZ, NZ, PZ only)	M25
Lead lining	M28
1-1/8" front, square corners (2-3/8" backset only)	M32
Request to Exit (REX) Switch (CL33900 only)	M92
Lever to accept Schlage® LFIC (AZ, NZ, PZ only)	M69
Rigid outside lever when locked	M200
Less cylinder, with tailpiece for Yale® 6-pin fixed core cylinder (all designs)	YC
Less cylinder, with tailpiece for Yale® 7-pin fixed core cylinder (all designs)	YC7
Lever to accept Yale® 6-pin LFIC (AZ, NZ, PZ only)	YRC

Finishes

CLX3300 Series

Finishes

	Description	Specify
ANSI/BHMA 605 (US3)	Bright Brass	605
ANSI/BHMA 606 (US4)	Satin Brass	606
ANSI/BHMA 611 (US9)	Bright Bronze	611
ANSI/BHMA 612 (US10)	Satin Bronze	612
ANSI/BHMA 613 (US10B)	Dark Oxidized Satin Bronze, Oil Rubbed	613
613E	Dark Oxidized Satin Bronze - equivalent	613E
613L	Dark Oxidized Satin Bronze, Clear Coated	613L
ANSI/BHMA 618 (US14)	Bright Nickel Plated	618
ANSI/BHMA 619 (US15)	Satin Nickel Plated	619
619C	Satin Nickel Plated with MicroShield®	619C
ANSI/BHMA 625 (US26)	Bright Chromium Plated	625
ANSI/BHMA 626 (US26D)	Satin Chromium Plated	626
626C	Satin Chromium Plated with MicroShield®	626C
722	Black Oxidized Bronze, Oil Rubbed	722
BSP	Black Suede Powder Coat	BSP
WSP	White Suede Powder Coat	WSP

Zinc levers are plated to match ANSI/BHMA finish.

Lock Finish	Cylinder/Core*
605, 606, 611, 612, 613, 613E, 613L, 722	606
618, 619, 625, 626, WSP	626
BSP	626

*Finish when cylinder provided with lock

Ordering Examples

Stock Order

Quantity	Series/Function	Trim Lever/Rose	Finish	Hand
100	CLX3355	NZD	626	RHR

Split Trim / Finish Order

Quantity	Series/Function	Trim Lever/Rose		Finish		Hand
		Outside	Inside	Outside	Inside	
12	CLX3355	NZD	AZD	626	625	LH

Contract / Detailed Order

Quantity	Keypad	Series/Function	Trim Lever/Rose	Finish	Hand	Door Thickness	Backset	Optional Strike	Misc. Options	Optional Cylinder	Keying
24	AA1	CLX3355	NZD	626	RHR	D214	B334	SC114	M04-M16	C6	VKC3

CL33900 Electrified Series

Quantity	Series/Function	Trim Lever/Rose	Finish	Hand	Voltage
6	CL33903	AZD	626	RH	12AD

How to Specify Handing:

Door hands determined from outside (secure side) of door.

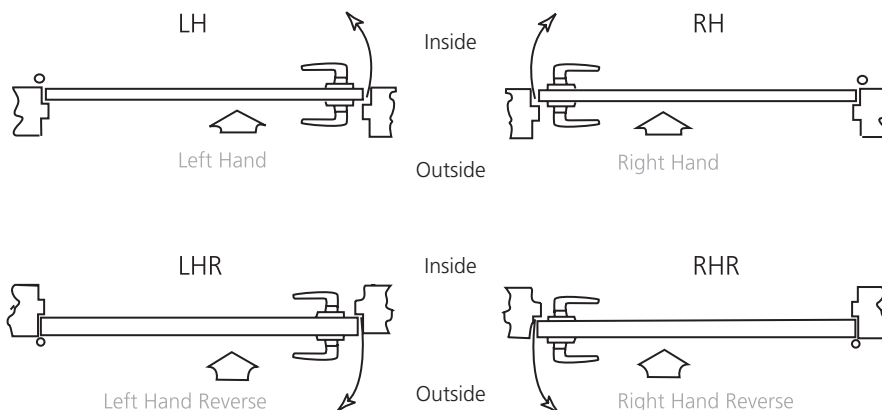

How to Specify

CLX3300 Series

CLX3300 Series Suggested Specification

- A. Locks shall be CLX3300 Series cylindrical lever locks as manufactured by Corbin Russwin, Berlin, CT.
- B. Locks shall be ANSI/BHMA Certified Products Directory (CPD) listed.
 - 1. A156.2, Series 4000, Grade 1
 - 2. A156.41
- C. Locks shall exceed the requirements of ANSI/BHMA A156.2 Series 4000, Grade 1 with all standard trims, as follows:
 - 1. Cycle Test: Exceeds ANSI/BHMA A156.2 Grade 1 requirements with no lever sag
 - 2. Abusive Locked Lever Torque: Exceeds 3,100 in-lb with no entry while maintaining egress (2.6 times ANSI/BHMA A156.2 requirements)
 - 3. Offset Lever Pull: Exceeds 1,600 lbs with no entry (8 times ANSI/BHMA A156.2 requirements)
 - 4. Latch Retraction with Preload: Exceeds 100lb preload while maintaining ANSI/BHMA requirements for operation in warped doors (2 times ANSI/BHMA A156.2 requirements)
 - 5. Vertical Impact: Exceeds 100 vertical impacts (20 times ANSI/BHMA A156.2 requirements)
- D. Locks shall comply with UL 10C positive pressure requirements.
- E. Locks required for fire doors shall be listed by Underwriters Laboratories for ratings of 3 hours (A label) and less, for doors up to 4'0" (1.2m) x 10'0" (3.0m) and pairs of doors 8'0" (2.4m) x 10'0" (3.0m)
- F. Locks shall have a push/turn button adjustable for door thickness without disassembly.
- G. Locks shall have a chassis design that supports all cylinder formats allowing flexibility for changing from fixed core to interchangeable core cylinders.
- H. Locks shall be non-handed with bi-directional lever operation.
- I. Lock levers shall be made of solid material.
- J. Lock shall be available in a minimum of seven different lever designs.
- K. Locks shall have a 2-3/4" (70mm) standard backset.
- L. Strikes shall be non-handed with a curved lip. Provide wrought boxes with strikes.
- M. Locks shall have brass 6-pin cylinder standard.
 - 1. Provide two nickel silver keys with each lock.
- N. Locks shall have approximately 45 degrees of lever rotation in order to fully retract latch.
- O. Locks shall have a ten-year limited warranty.

Notes

CLX3300 Series

The ASSA ABLOY Group is the global leader in access solutions. Every day, we help billions of people experience a more open world.

ASSA ABLOY Opening Solutions leads the development within door openings and products for access solutions in homes, businesses and institutions. Our offering includes doors, frames, door and window hardware, locks, perimeter fencing, access control and service.



For additional information, contact your
ASSA ABLOY Door Security Solutions
sales consultant or visit www.corbinruswin.com.

In U.S.

Corbin Russwin
225 Episcopal Road
Berlin, CT 06037
Phone: 800-543-3658
Fax: 800-447-6714
www.corbinruswin.com

In Canada

ASSA ABLOY Door
Security Solutions Canada
160 Four Valley Drive
Vaughan, Ontario
Canada L4K 4T9
Phone: 800-461-3007
Fax: 800-461-8989
www.assaabloydss.ca

MicroShield®

ASSA ABLOY Group companies offer MicroShield®, an anti-microbial coating for door hardware. MicroShield uses proven silver ion-based technology from Agion®, a leading provider of antimicrobial solutions, to stem the spread of bacteria and other microbes.

MicroShield® is a trademark of ASSA ABLOY Access and Egress Hardware Group, Inc.



The Agion antimicrobial is not intended as a substitute for good hygiene. Coated products must still be cleaned to ensure the surfaces will be free of destructive microbes. ASSA ABLOY makes no representations or warranties, express or implied, as to the efficacy of the Agion antimicrobial. A copy of the Agion warranty is available upon request. Agion is a registered trademark of Agion Technologies, Inc., Wakefield, MA, USA.