



The **radically simplified** access control platform for small and growing businesses.

US Pricing Catalog Effective February 4th, 2025



Be there when you can't be there.

Centrios is the access control platform that allows you to be exactly where you need to be no matter where you are.

Grant access to employees or vendors, quickly unlock your openings with a touch of your phone, easily manage schedules and view access history.



Software and hardware designed for businesses — easy to install and simple to use.



2-year warranty and 24/7 support resources.



Training and video installation guides available on demand.



Manage up to 50 doors and 200 users in a single system — while also being part of multiple systems.

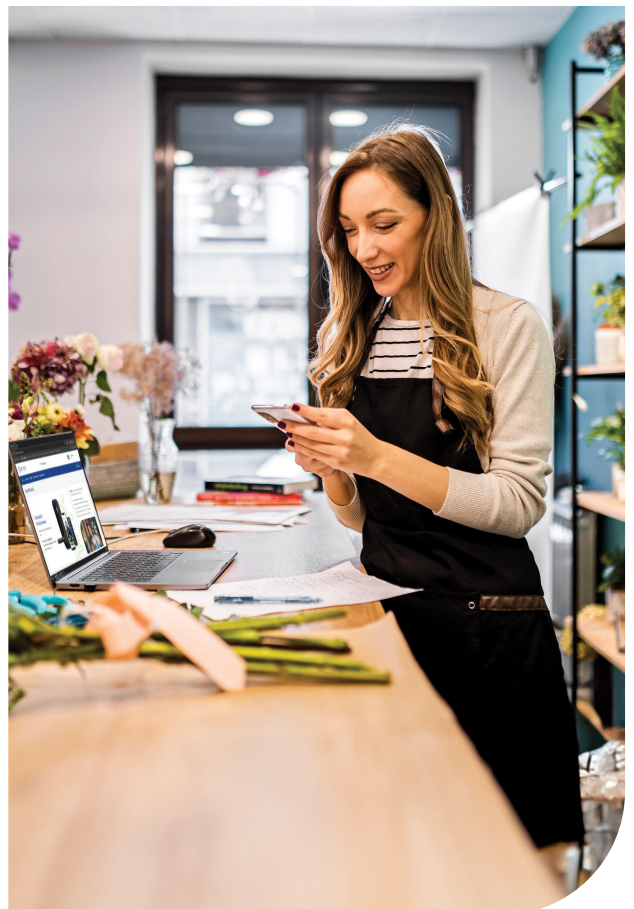

Subscription Plans

Pro-Plan Coming Soon.

No contracts. No hidden fees. No fine print.

 centrios Subscription Plans	Free \$0^{USD} per month	Select \$10^{USD} per month	 PRO \$20^{USD} per month
Number of openings	Up to 5	Up to 20	Up to 50
Number of people	Up to 10	Up to 100	Up to 200
Update hardware and change settings	Locally via phone	Locally via phone	Locally via phone
People access schedules	24/7 access	Customizable schedules	Customizable schedules
Audit and event reports	✓	✓	✓
Phone app credentials	✓	✓	✓
PIN codes (Smart Reader only)	✓	✓	✓
Centrios Card or Fob credentials			✓

To learn more about our Subscription Plans or to upgrade, visit: centrios.com

Cards & Fobs.

Available for pre-order.

Cards and Fobs offer even more options to lock or unlock openings in your business. Compatible with Centrios Cylindrical Locks and Smart Readers, Centrios Cards and Fobs make it easy to share and manage access, even if you or your employees don't have a phone!

Cards and Fobs are enabled by the Pro Plan



How to order

Model	Description	List Price
CE-FOB	Centrios Branded Fob	\$13
CE-CARD-B	Centrios Branded Card	\$13
CE-CARD-NB	Centrios Plain White Card	\$15

List prices shown are for each credential.
 Branded Cards or Fobs are only available in denominations of 25. For example 25, 50 etc.
 Plain White Cards only available in denominations of 50. For example 50, 100 etc.

Mobile App

The Centrios Mobile App is designed to work seamlessly together with Centrios hardware. Get started, enroll devices, add users, manage schedules, and access your business all in one place!

Manage Systems

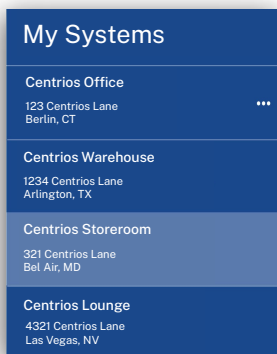

Manage Schedules

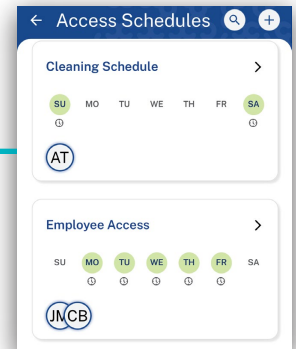

Manage Devices

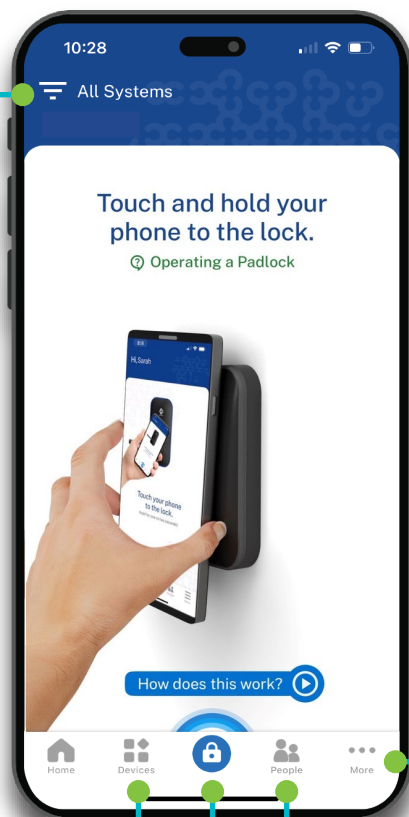
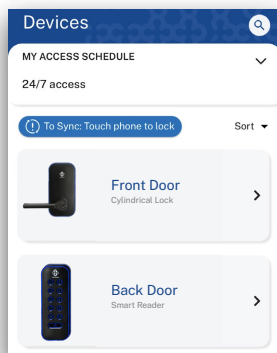

Manage People

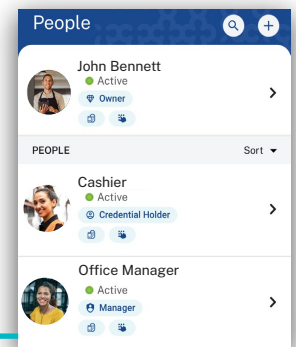

Unlock Devices

The Centrios mobile app is incredibly easy to navigate and use — no training required.

Quickly and securely manage who has access to what in your business. And with one flat monthly fee, you always know exactly how much you are paying to access all of the features, devices, and users in your plan.

Download the **Centrios App** today



Padlock

CEP

Available for pre-order.

The Centrios Padlock was designed to safeguard your assets both inside and outside your business. It's the perfect way to share secure access with one or multiple people without handing out a key.

Features & Benefits

- IP67 rated waterproof and dust-tight for indoor and outdoor applications
- For use in harsh environments, 240 hour salt spray tested
- Solid brass body (corrosion resistant)
- Reinforced chromed steel shackle with 28.1 kN cutting resistance (6300lbs of cutting force)
- Operational temperature: 2°F to 120°F (-19°C to 49°C)
- Charging temperature: 32°F to 113°F (0°C to 45°C)



Bluetooth mobile access via the Centrios mobile app.



Operates up to 6 months on one charge.
USB-C cable and 5V charger required (not included).



Unique LED for device status.



Configurable settings for people access schedules.

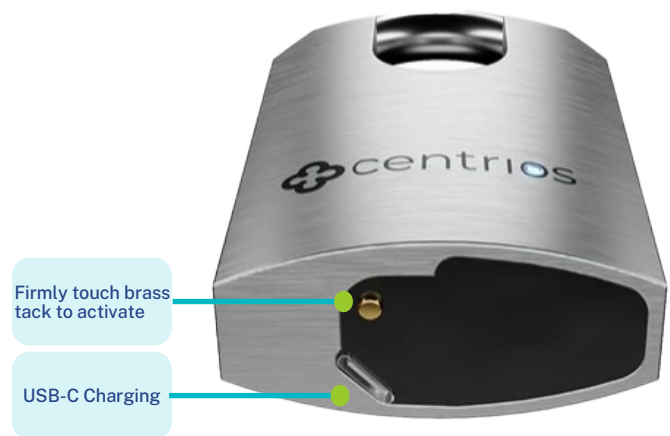

How to order

Model	Description	List Price
CEP200-626	Centrios Padlock Satin Chrome	\$276

Smart Reader

CER

The Centrios Smart Reader enables you to unlock virtually any door with electrified hardware from perimeter openings, to garages, glass doors, and gates.

Features & Benefits

- Capacitive keypad
- FCC/IC Certified
- ADA Compliant
- 2 configurable output relays
- 2 inputs (Door Position Switch & Request to Exit)
- -40°F to 122°F (-40°C to 50°C)
- Compatible with Centrios Cards & Fobs



Bluetooth mobile access via the Centrios mobile app.



Two relays, one designed for an electronic lock, the second for an auto-operator with configurable delay. Request to exit input (REX). Door position switch (DPS) input. Triggers auto-operator on delay.



12-24 VDC. Dedicated power source recommended. Relays support up to 2 amps.



Mounts to frames, walls, or a J-box (trim plate included). Simple installation: 2 screws and back plate.



How to order

Model	Description	List Price
CER	Centrios Smart Reader	\$799

Smart Reader Kits

We have created a set of bundled kits to make purchasing everything you need for your Smart Reader convenient and hassle-free. Each kit includes your Smart Reader and the products from whichever kit you choose below.

Products	Description	Orderable kits					
		CER-5000C-630	CER-1500C-630	CER-9400-630	CER-9600-630	CER-7400-628	CER-CYOH-KIT
CER	Centrios Smart Reader	✓	✓	✓	✓	✓	✓
HES-5000C-630	Compact electric strike; selectable fail secure/fail safe, accommodates 5/8" latchbolts, stainless steel.	✓					
HES-1500C-630	Electric strike with 1500lbs static strength, field selectable, fail secure/fail safe, non-handed, 3-hour fire rating, stainless steel finish.		✓				
HES-9400-630	Slim line outdoor rated strike ideal for rim exit devices with a 1/2" throw latch.			✓			
HES-9600-630	Outdoor rated strike ideal for rim exit devices with a 3/4" throw latch.				✓		
Adams Rite 7400-628	Ultra-compact strike, over 1,500 lbs holding force. Adjustable stainless steel keepers, release electrically with up to 25 lbs preload.					✓	
Securitron AQD2	Dual voltage power supply, UL listed, supervised, 2A, 12VDC/24VDC, w/battery charging circuit.	✓	✓	✓	✓	✓	✓
Alarm Controls NTB-3	No touch request to exit station with hand-waving motion to exit.	✓	✓	✓	✓	✓	✓
Securitron DPS	Used to monitor status of door opening.	✓	✓	✓	✓	✓	✓
List Price		\$2468	\$2938	\$2867	\$2867	\$2632	\$2233

More Information

Information on the products that come in the Smart Reader Kits.

HES 5000C

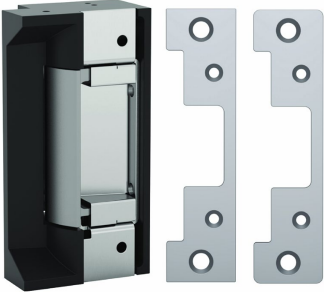

The 5000 series is a compact, high performance electric strike designed for low profile openings where there is limited space behind the jamb.

HES 1500



The HES 1500 Series Electric Strike sets a new standard in the industry by offering dynamic integrated adjustability and field configurable options compatible with any cylindrical or mortise lock.

Adams Rite 7400

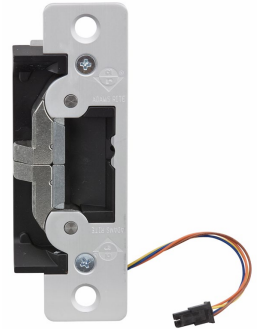

Designed for use with Adams Rite deadlatches or cylindrical lock-sets with 1/2" [12.7 mm] to 5/8" [15.9 mm] latchbolt projection.

HES 9400



The HES 9400 series is a slim-line, outdoor rated surface mounted electric strike designed to accommodate rim exit devices with a 1/2" Pullman latch.

HES 9600



The 9600 Series is a windstorm rated, surface mounted electric strike designed to accommodate rim exit devices with a 3/4" throw latch.

Alarm controls NTB-3

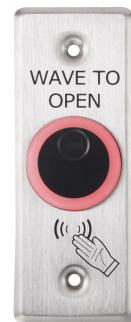

These surface mounted, request to exit solutions provide greater flexibility, without the need to make costly modifications, extending access control in an easy way.

Securitron DPS



Used to monitor the status of a door. Includes a magnetic switch and a cylindrical permanent magnet.

Securitron AQD2



The UL-listed Securitron AQD2 Series of dual voltage, field selectable switching power supplies provides 2 Amps at 12 VDC.

Cylindrical Lock

CEB100/102

The Cylindrical Lock is designed specifically with business owners in mind. Engineered for speed of installation, ease of use, and mixed functionality, the Cylindrical Lock is perfect for front doors, back doors, storeroom doors, offices, or anywhere that has a 2 1/8" hole in the door!

Features & Benefits

- ANSI/BHMA A156.2 Grade 1
- UL10C 3-hour fire rating
- IP67 weather resistance to allow full exposure to both sides of the door
- FCC/IC Certified
- ADA compliant
- Deadlocking latch
- -35°F to 140°F (-37°C to 60°C)
- Compatible with Centrios Cards & Fobs



Bluetooth mobile access via the Centrios mobile app. Privacy mode with included door position sensor installation. Full-time passage egress.



Operates up to one year on four AA batteries (included). Exterior emergency 9 VDC power backup.



Unique LED for lock events and alarms. Key in lever design for fixed core. Configurable auto relock. Wireless door position sensing (DPS).



Designed to be quick and easy to install — with in-field handing and patent pending automatic adjustability for doorthicknesses between 1-3/8" to 2-1/4".



Black
Suede
BSP



Satin
Chrome
626

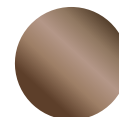

Bronze
613E



Bright
Brass
605



Satin
Nickel
619

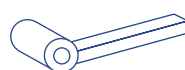

Taylor Bay
(TB)



Pacific Beach
(PB)



Monroe
(MO)



Augusta
(AU)

How to order

Model	Description	Lever Syles	Lever Finish	CEB100 only			CEB100 only	
				Cylinder	Backset & Latch	Strike	Keying Options	List Price
CEB100	Cylindrical lock Key-in lever	TB ¹	BSP <i>Black Suede</i>	1803-54L <i>Fixed Core</i>	CE-234R <i>2 3/4" Round Corner Latch</i>	497 <i>ANSI 4 7/8"</i>	KR <i>(Keyed Random for 1803-54L)</i>	Starting at \$680
		—	626 <i>Satin Chrome</i>	—	—	—		
CEB102	Cylindrical lock Key-free	AU	605 <i>Bright Brass</i>	LC ⁴ <i>(-\$94) Less Cylinder</i>	CE-234S <i>2 3/4" Square Corner Latch</i>	70S <i>Square Corner Full Lip Strike</i>		
		—	613E ² <i>Bronze</i>	—	—	—		
		PB	619 ³ <i>Satin Nickel</i>	SFICLC ⁵	CE-238R <i>2 3/4" Round Corner Latch</i>	71S <i>Round Corner Full Lip Strike</i>		
		—	—	—	—	—		
—	—	MO	—	LFICLC ⁵	CE-238S <i>2 3/4" Square Corner Latch</i>	371 <i>T-Strike</i>		

¹ TB is not available in LFIC.

² Products ordered with 613E levers include brass finish latches and strikes. If ordered with the 1803-54L fixed core cylinder, the cylinder includes a brass cylinder front.

³ Products ordered with 619 levers include 626 finish latches and strikes. If ordered with the 1803-54L fixed core cylinder, the cylinder includes a 626 cylinder front.

⁴ Specifying this option indicates you will receive a lever that supports the 1803-54L cylinder style. Cylinder not included.

⁵ Specifying these options indicates you will receive a lever that supports these cylinder styles. Cylinder not included.

Order string example

CEB100-AU-BSP-1803-54L-CE-234R-497-KR

Need it in a hurry?

We know how important it is to keep your inventory stocked and your customers happy with fast delivery. That's why we've selected our most popular products that are ready to ship with shorter than standard lead times. Choose from the two different lever and finish styles below.

Model	Lever Style	Lever Finish	Cylinder	Backset & Latch	Strike	Keying Options	List Price
CEB100	TB	BSP	1803-54L <i>(Fixed Core)</i>	CE-234R <i>2 3/4" Round Corner Latch</i>	497 <i>ANSI 4 7/8"</i>	KR <i>(Keyed Random for 1803-54L)</i>	\$680
	—	626					

Definitions & Dimensions

Strikes

Centrios offers four strike styles to accommodate the most common applications. You must select a strike when placing your Centrios Cylindrical Lock order.

When planning your installation, review the existing strike and verify if the existing latch has a square or round corner so you can order accordingly.

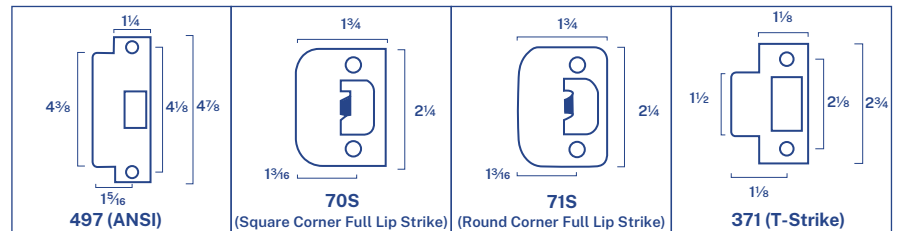

Latches

Centrios offers two different latch styles for the Cylindrical Lock. Square corner, and round corner.

When planning an installation, verify if the existing latch has a square or round cornered latch so that you can order accordingly.

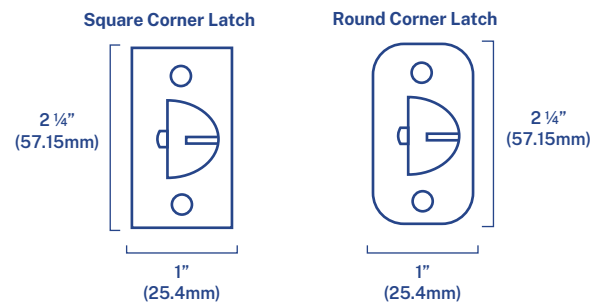

Backsets

A standard measurement is 2 3/4" or 2 3/8". Centrios Cylindrical latches only support backsets with these measurements. You must select a backset when placing your Centrios Cylindrical Lock order.

When planning your installation, review the existing backset so you can order accordingly.

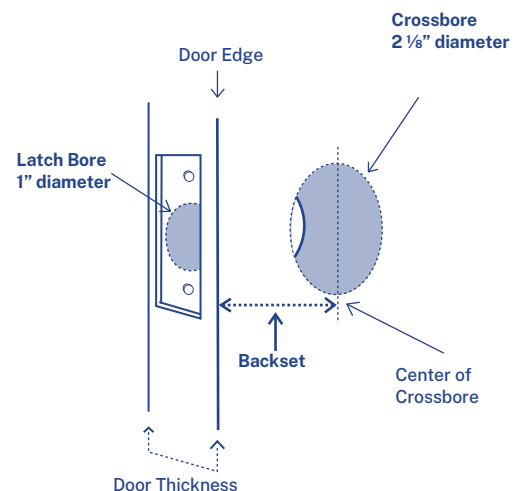

Accessories

Additional latches available for purchase.

Description	Model	Finish	List Price
2 3/4" Backset Square Corner Latch	CE-234S	BSP 626	\$122
2 3/4" Backset Round Corner Latch	CE-234R		
2 3/8" Backset Square Corner Latch	CE-238S		
2 3/8" Backset Round Corner Latch	CE-238R		

Order String Example

CE-234R-BSP

Available for Purchase

Sample Mounts

If you are interested in purchasing a sample mount for the Centrios Smart Reader or Cylindrical Lock, please contact hello@centrios.com.



Cylindrical Jig

The Centrios Drill Jig makes it easy to drill 5/16" holes at the 12 o'clock and 6 o'clock position to install the cylindrical lock on a 161 prep door.



Model	List Price
CE-DRILL-JIG	\$25

Cover Plates

Cover Plates are perfect for covering up old holes and paint lines from previous lock installs. This product always comes with (2) plates, one for each side of the door and supports both Centrios Cylindrical and Mortise Locks. Installs without the need for additional screws to affix the plate to the door.

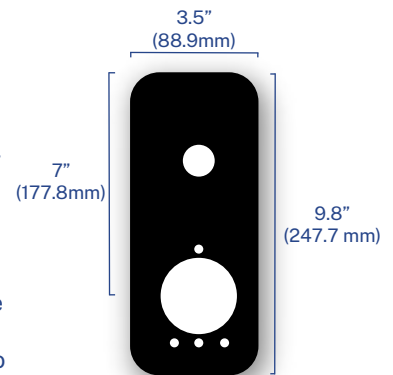

How to order

Model	Finish	List Price
CE-COVERP	BSP	\$80
	626	

Order String Example

CE-COVERP-626

Radically Simplified.

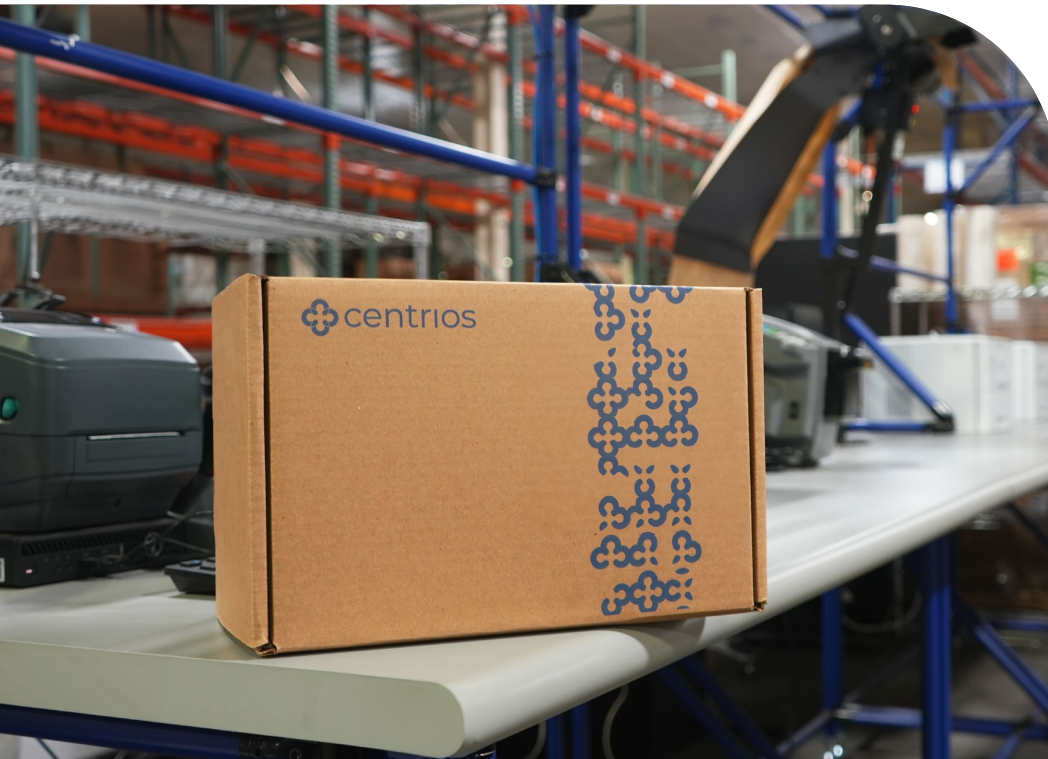

Contact us

Centrios
Address: 225 Episcopal Road
Berlin, CT 06037-4004
Phone: 888-425-1001
www.centrios.com

24/7 Support
www.support.centrios.com

Order Management
orders@centrios.com

Technical Product Support
tech@centrios.com
888-425-3404

Customer Experience
care@centrios.com
888-425-3403

Hours
Monday - Friday
8am - 8pm EST

Copyright © 2025
All rights reserved. Reproduction in whole or in part without the
express written permission of Centrios is prohibited.
Patent pending and/or patent www.assaabloydss.com/patents.

Part of ASSA ABLOY

FREIGHT TERMS

All Purchase Orders received with a minimum value of \$3,500 will qualify automatically for free standard freight within the continental United States. This minimum amount applies per Purchase Order to qualify and does not include free expedited freight. Qualified orders may ship partial or ship complete at your preference. Qualified orders that ship partial will not incur freight charges. All shipments that do not qualify for free freight will be charged for freight based upon our terms in effect at the time of shipment.

Customers may provide their own carrier account number for expedited freight methods or for any Purchase Order to be used to cover freight costs. Minimum amounts are subject to change without notice.

RETURNS

There will be a 35% restocking fee for all returned product. For a return/restock, product must be in original, unmarked, undamaged, and re-sellable cartons, be valued in excess of \$250.00 net, have shipped and been invoiced within the past 120 days, not be custom, non-cataloged, or master keyed.

All orders sent back for restocking must be approved and are subject to inspection upon receipt. Restocking fees will be deducted from the value of the credit following inspection.

For full warranty terms, please visit www.centrios.com/en/warranty

For full terms and conditions, please visit
www.centrios.com/en/freightterms

80-9000-0008-02/25