

# RESIDENTIAL MECHANICAL PRICE BOOK

## US and Canada Prices Effective February 2, 2026

**TARIFF PRICE ADJUSTMENTS EFFECTIVE:**  
(In Addition to Prices Herein)  
**Canada Link:** [2026 Tariff Price Adjustments](#)

*THIS PRICE BOOK SUPERSEDES AND TAKES PRECEDENCE OVER ANY OF OUR PRODUCT CATALOGS IN TERMS OF PRODUCT AVAILABILITY.*

*CONTACT ASSA ABLOY ACCENTRA™ FOR PRICES AND AVAILABILITY OF NON-STANDARD AND SPECIAL ITEMS NOT LISTED IN THIS PRICE BOOK.*



# CONTENTS

Terms of Sale Ordering Information ..... 3

Heritage Collection Grade 2 ..... 10

    Interconnected ..... 11

    Levers ..... 16

    Knobs ..... 21

    Deadbolts ..... 24

Heritage Collection Grade 3 ..... 28

    Levers ..... 29

    Knobs ..... 32

    Deadbolts ..... 35

Decorative Handlesets ..... 39

Strikes ..... 43

Keys & Keying Options ..... 44

Cylinders ..... 45

Accessories ..... 46

Residential Heritage Collection Master Key Order Leadsheet ..... 48

## FINISHES

Please check each product’s specifications for availability.

ANSI/BHMA Code Finish Description				
<b>605</b> Bright Brass, Clear Coated	<b>609</b> Antique Brass	<b>10BP</b> Oil Rubbed Bronze Permanent	<b>613E</b> Dark Oxidized Satin Bronze - equivalent	<b>619</b> Satin Nickel Plated, Clear Coated
				
<b>620</b> Antique Nickel	<b>625</b> Bright Chrome Plated	<b>626</b> Satin Chrome Plated	<b>GM</b> Gun Metal	<b>BSP</b> Black Suede Powder Coat
				

US and Canada Prices Effective February 2, 2026 / [Canada 2026 Tariff Price Adjustments](#)

# ASSA ABLOY ACCENTRA®

## TERMS AND CONDITIONS OF SALE



### Terms & Conditions

Minimum freight requirements apply. The Terms and Conditions contained on the ASSA ABLOY ACCENTRA® Website, as published from time to time, shall apply to all purchases of Goods. To the extent that any terms in any invoice conflict with the terms of the Price List, the terms of the Price List shall govern.

### Applicable Law; Definitions

All sales of ASSA ABLOY ACCENTRA® branded goods ("Goods") shall be governed by the laws of the State of Connecticut, including the Uniform Commercial Code as in effect in Connecticut on the date of sale (the "Code"). Whenever a term defined by the Code is used in these Terms and Conditions of Sale, the definition contained in the Code shall apply here. The purchaser of the Goods agrees that any proceeding brought in connection with the purchase of the Goods shall be brought in any court of competent jurisdiction in Connecticut.

### Purchase Price

The purchase price of the Goods is subject to change without notice, and the prices prevailing at the time the Goods are shipped by ASSA ABLOY ACCENTRA® shall apply unless ASSA ABLOY ACCENTRA® has agreed in writing to a different price or has given a prior written quotation which constitutes a firm offer. ASSA ABLOY ACCENTRA® does not guarantee that the price, terms and conditions for reorders of the Goods will be the same as contained in the ASSA ABLOY ACCENTRA® Price List. Rebates or refunds for Goods that represent dealer stock on hand or for Goods already shipped by ASSA ABLOY ACCENTRA® will not be given due to any price reduction. The purchase price for any Goods purchased shall be due as and when specified in the invoice covering such Goods. Title to the Goods shall not pass to purchaser until full payment for the Goods is made to ASSA ABLOY ACCENTRA®.

### Binding for all Purchases

All orders, whether solicited or written by our representatives or delivered by you are deemed offers by you to purchase our products

Our acceptance of each such offer is expressly subject to and conditioned on your assent to the Terms and Conditions of Sale contained herein (assent may be deemed to occur if we do not receive a written objection or retraction of such offer within 48 hours after you receive our confirmation of receipt of such offer). No other terms or conditions shall apply.

### Prices and Minimum Charges

All prices are subject to change without notice and are not guaranteed. All shipments will be made at prices in effect at the time of shipment. Possession of this price list does not constitute an agreement to sell. We reserve the right to correct clerical, stenographic and other obvious errors at any time.

### Payment

Standard sales terms are 2/10 net 30. The 2.0% discount only applies for invoices paid in full within 10 days of invoice date.

Invoices not paid in full within 30 days of invoice date shall incur a service charge of 1.5% per month for each month or fraction thereof (or the maximum rate permitted by law) until paid in full. All delinquent accounts are subject to credit hold.

### Freight

All orders are shipped FOB factory/warehouse, except as expressly provided below. When delivered to the Transportation Company, the Purchaser assumes the risk of loss or damage in transit. Customer orders with net product value in excess of \$7,000.00 will be shipped prepaid by the ASSA ABLOY ACCENTRA® carrier of choice to a single destination point in the United States.

Customer orders with net product value less than \$7,000.00 will be shipped prepaid by the ASSA ABLOY ACCENTRA® carrier of choice and freight and handling charges will be added to the customer's invoice. The minimum freight and handling charge will not apply to orders for only Cut (bitted) keys of any type, Master keys, Master keyed cylinders or padlocks and factory generated biting lists that do not have any other product types included on the order. Freight on these orders will be charged as the percentage of invoice value.

For orders with net product value greater than \$400.00 and less than \$7,000.00, freight charges will be calculated as a percentage of the net invoice value and will be added to Customer's invoice. The percentage is based on the National U.S. Average On Highway Diesel Fuel Prices as reported by the US Department of Energy in effect at the beginning of each quarter. On the first Monday of each quarter, the new rate will be published on the ASSA ABLOY ACCENTRA® and Door Security Solutions extranet and will go into effect on the 2nd Monday of the quarter. Please refer to the ASSA ABLOY ACCENTRA® distributor extranet for the rate chart and information on the current freight charge percentage. The percentage in effect at the time of shipment of the order will be charged. Great Grand Master keys, Grand Master keys, Master keys, Construction Master keys, Control Keys, and Change Keys which are shipped separate from customer order for security reasons, on orders with total net product value in excess of \$7,000.00 will be shipped prepaid by the ASSA ABLOY ACCENTRA® carrier of choice. If the total order value is less than \$7,000.00, the shipping charges will be added to Customer's invoice.

If a customer provides their own freight account number for the freight charges, ASSA ABLOY ACCENTRA® will apply a handling fee of \$25.00 to the invoice.

**Expedited shipping options** – If the customer requests an expedited method of shipment such as "Next Day Air" the charges will be prepaid by ASSA ABLOY ACCENTRA® and the full rate for the service, as published by the carrier, will be added to the customer's invoice.

**Packing** – ASSA ABLOY ACCENTRA® will pack, mark and ship the products according to its standard procedures for shipment, unless the parties agree, in writing, that ASSA ABLOY ACCENTRA® will comply with any special instructions provided by the customer. Special instructions must be submitted, in writing, at time of order placement. Compliance with special instructions may result in an increased price.

Discrepancies must be noted with carrier upon receipt as they are your responsibility to claim.

### Minimum Annual Purchase Requirement

We may discontinue direct sales to you if you do not meet the minimum annual purchase requirement (currently \$10,000), based on total accepted, shipped and non-canceled orders within each calendar year.

### Limited Warranty

ASSA ABLOY ACCENTRA® (the "Warrantor") warrants that its products sold under the ASSA ABLOY ACCENTRA® brand name in the United States of America & Canada are free from defects in workmanship and materials under normal use and service.

The only liability of the Warrantor in tort or contract whether under this warranty or otherwise shall be limited to the repair or replacement of any product or component part which shall prove defective as covered by this warranty, within the stated time frame listed below, after delivery to the original purchaser.

For additional information, visit <https://go.assaabloydss.com/ASSAABLOYACCENTRA>  
1.855.686.2204

US and Canada Prices Effective February 2, 2026 / [Canada 2026 Tariff Price Adjustments](#)

# ASSA ABLOY ACCENTRA® TERMS AND CONDITIONS OF SALE



## 1. MECHANICAL PARTS & FINISH.

ASSA ABLOY ACCENTRA®, extends the following LIMITED WARRANTY to the original purchaser for a single family home, (herein the "lockset" or "locksets") shipped to, and installed in the U S or Canada. Because the Company cannot control the quality of Devices sold by unauthorized sellers, this Warranty applies only to Devices purchased from ASSA ABLOY ACCENTRA® or an ASSA ABLOY ACCENTRA® authorized seller in the United States of America, unless otherwise prohibited by law. ASSA ABLOY ACCENTRA® reserves the right to reject warranty claims from purchasers for Devices purchased from unauthorized sellers, including unauthorized internet sites.

ASSA ABLOY ACCENTRA® provides a ONE (1) YEAR warranty on finish and TWO (2) YEAR warranty on mechanical Devices for collections listed below:

Heritage Collection Grade 2

Heritage Collection Grade 3

Navis Paddle

## 2. CONDITIONS AND EXCEPTIONS.

This Limited Warranty shall apply only when the lockset is properly installed in accordance with local codes, ordinances and regulations, the printed instructions provided with it and good industry practices. THIS WARRANTY DOES NOT COVER defects caused by: modification, alteration, repair or service of the lockset by anyone other than Warrantor or an authorized designee of Warrantor; physical abuse to, or misuse of, the lockset or operation of it in a manner contrary to the accompanying instructions; shipment of the product to anyone other than Warrantor for service; improper installation; acts of God; fire; flood; casualty; failure to exercise normal maintenance; for the consequences of uses for which locksets were not designed or designated, or for defects caused by the use of paints, solvents or other chemicals which come in contact with the lockset.

THIS WARRANTY DOES NOT COVER scratches or abrasions. THIS WARRANTY DOES NOT APPLY to locksets or component parts of locksets that were not originally manufactured by Warrantor. THIS WARRANTY SHALL NOT APPLY TO SUBSEQUENT OWNERS.

## 3. SERVICE AND REPAIR EXPENSE.

Under this Limited Warranty the Warrantor will provide only a replacement lockset or a part of it. Warrantor will pay reasonable shipping costs for surface transportation only for locksets returned to Warrantor's Customer Service Department. Warrantor will ship replacement parts under this Limited Warranty at its expense by surface transportation only. Any special handling, express or expedited service or different method of transportation shall only be provided at the request and expense of the purchaser of the locksets. However, if warrantor determines that a lockset does not qualify for repair or replacement under the applicable Limited Warranty, Warrantor will notify the consumer of the estimated costs of repair or replacement and obtain the consumer's authorization and agreement to pay actual repair or replacement costs before proceeding with non-warranty repair or replacement. Warrantor shall have no liability to pay any costs for repairs performed by anyone other than Warrantor or its designee, unless in each instance Warrantor has given written approval for such repair. Warrantor shall not be responsible for any costs incurred for the removal or reinstallation of locksets covered by this Limited Warranty.

## 4. LIMITATION ON IMPLIED WARRANTIES.

ANY EXPRESS WARRANTY NOT PROVIDED IN THIS LIMITED WARRANTY, AND ANY REMEDY FOR BREACH OF CONTRACT THAT, BUT FOR THIS PROVISION, MIGHT ARISE BY IMPLICATION OR OPERATION OF LAW, IS EXCLUDED AND DISCLAIMED. THE IMPLIED WARRANTIES OF MERCHANTABILITY AND OF FITNESS FOR ANY PARTICULAR PURPOSE ARE EXPRESSLY LIMITED TO THE DURATION OF EACH EXPRESS WARRANTY PERIOD.

1.855.686.2204

US and Canada Prices Effective February 2, 2026 / [Canada 2026 Tariff Price Adjustments](#)

4

Copyright © 2025, 2026, ASSA ABLOY Access and Egress Hardware Group, Inc. All rights reserved. Reproduction in whole or in part without the express written permission of ASSA ABLOY Access and Egress Hardware Group, Inc. is prohibited. Patent pending and/or patent [www.assaabloydss.com/patents](http://www.assaabloydss.com/patents).

a. Should the locksets be considered a consumer product as may be covered by the Magnusson-Moss Federal Warranty Act, please be advised that some states do not allow limitations on how long an implied warranty lasts, so the above limitation may not apply to you.

## 5. CLAIM PROCEDURE.

To obtain performance of any obligation under this Limited Warranty, you must contact: ASSA ABLOY ACCENTRA® Technical Product Support, 225 Episcopal Road, Berlin, CT 06037 USA, Tel 1-855-686-2204 option 1 Fax 1-800-338-0965.

a. The Warrantor will only honor replacement with an identical or similar lockset or parts of it which are manufactured or distributed by the Warrantor.

b. Customer service department hours are M-F 8:00am - 4:30pm, except holidays.

## 6. DISCLAIMER.

THERE ARE NO WARRANTIES THAT EXTEND BEYOND THE DESCRIPTION ON THE FACE OF THIS DOCUMENT. NO OTHER EXPRESS WARRANTY HAS BEEN MADE OR WILL BE MADE ON BEHALF OF THE WARRANTOR WITH RESPECT TO THE LOCKSET OR THE INSTALLATION, OPERATION, REPAIR OR REPLACEMENT OF THE LOCKSET. THE MAXIMUM LIABILITY OF ASSA ABLOY ACCENTRA® HEREUNDER IS LIMITED TO THE PURCHASE PRICE OF THE LOCKSET. UNDER NO CIRCUMSTANCES SHALL ASSA ABLOY ACCENTRA® BE LIABLE TO PURCHASER OR ANY OTHER PERSON FOR ANY SPECIAL OR CONSEQUENTIAL DAMAGES, WHETHER ARISING OUT OF TORT, BREACH OF WARRANTY, BREACH OF CONTRACT OR OTHERWISE.

a. Should the locksets be considered a consumer product as may be covered by the Magnusson-Moss Federal Warranty Act, please be advised that (i) some states do not allow the exclusion or limitation of incidental or consequential damages, so the above limitation or exclusion may not apply to you, and (ii) this Limited Warranty gives you specific legal rights, and you may also have other rights which vary from state to state.

b. Warrantor reserves the right to make changes in designs and specifications or to make additions or improvements on its products without notice and without incurring any obligation to incorporate them on products previously manufactured.

## General Conditions

(a) Shipping; Acceptance; Risk of Loss; Security Interest. Any shipment date given by ASSA ABLOY ACCENTRA® is approximate and not a guarantee of delivery on the shipment date. Failure of a purchaser to inspect the Goods and notify ASSA ABLOY ACCENTRA® or any authorized distributor or factory representative in writing of such purchaser's rejection of any Goods upon completion of inspection within 24 hours after receipt of shipment, in each case setting forth the specific grounds for rejection, shall constitute unconditional acceptance of the Goods. Title to the Goods shall not pass until the full purchase price therefore has been paid in full. If after acceptance, the purchaser fails to pay the full purchase price as and when due, ASSA ABLOY ACCENTRA® shall be entitled to a writ of immediate possession to recover possession of the Goods. Risk of loss or damage to the Goods passes to the purchaser upon delivery of the Goods to the carrier regardless of who pays the shipping costs for such Goods. The purchaser hereby grants to ASSA ABLOY ACCENTRA® a continuing security interest in and to the Goods purchased from and/or financed by or through ASSA ABLOY ACCENTRA® to secure repayment of any debt or obligation owed to ASSA ABLOY ACCENTRA® by the purchaser.

(b) Force Majeure. Under no circumstances shall ASSA ABLOY ACCENTRA® be liable for failure or delay in delivery occasioned in whole or in part by fire, flood, explosion, casualty, accident, acts of God or natural catastrophe, war, riot, strike, lock-out or other labor dispute or industrial disturbance, embargo, law, regulation, ruling, order or requirement of

# ASSA ABLOY ACCENTRA® TERMS AND CONDITIONS OF SALE



any government or government agency or authority, court, tribunal or military authority, shortage or failure of, or ASSA ABLOY ACCENTRA's inability to obtain, Goods, appropriate supplies, materials, equipment, transport or labor, or any other cause or circumstance beyond ASSA ABLOY ACCENTRA's control, including delays due to a purchaser's acts omissions or rush circumstances. Under such circumstances, ASSA ABLOY ACCENTRA® may extend the date of delivery for a reasonable period of time after the period of the delay, apportion its products among its customers in such manner as it deems equitable and substitute for products which cannot be obtained within a reasonable period of time, and the purchaser shall not be relieved of accepting delivery of such products.

(c) No Other Warranty. The only warranty given in connection with any Goods sold by ASSA ABLOY ACCENTRA® is its Limited Warranty to the first purchaser-user provided in Section 3 of these Terms and Conditions of Sale, and no other representations or warranties of any kind shall be made or given by any distributor or other person in connection with the sale of the Goods.

### **Enforcement Policy**

In the event ASSA ABLOY ACCENTRA® deems it necessary to collect any amount due it from any purchaser, the purchaser shall pay to ASSA ABLOY ACCENTRA®, upon demand, all costs and expenses of such collection or enforcement including, without limitation, reasonable attorneys' fees and all other costs of collection. In addition, ASSA ABLOY ACCENTRA® will assess a 1.5% finance charge per month (18% APR) on amounts not paid when due.

### **Returned Goods Policy**

ASSA ABLOY ACCENTRA® will not accept returned Goods from purchasers for credit or exchange. Under limited exceptions the following conditions generally would apply:

- (a) Written consent to the return of the Goods must be obtained from the ASSA ABLOY ACCENTRA® Customer Service Manager prior to returning the Goods (at ASSA ABLOY ACCENTRA's discretion);
- (b) Any returned Goods shall be accompanied by a completed Merchandise Return Authorization Form provided to the purchaser by ASSA ABLOY ACCENTRA®;
- (c) Shipping charges and insurance must be prepaid by the purchaser;
- (d) All returned Goods accepted by ASSA ABLOY ACCENTRA® shall be subject to a minimum charge of 45% of the original purchase price or the current price, whichever is lower, to cover the cost of testing and repackaging. Additional charges may be imposed if the returned Goods, in the opinion of ASSA ABLOY ACCENTRA®, require reconditioning; and
- (e) Any credit given will be based on the original purchase price or the current price for the returned Goods, whichever is the lower.

### **Terms and Conditions Contained in ASSA ABLOY ACCENTRA® Price Book**

The Terms and Conditions contained in the ASSA ABLOY ACCENTRA® Price Book, as published from time to time, shall apply to all purchases of Goods. To the extent that any terms in any invoice conflict with the terms of the ASSA ABLOY ACCENTRA® Price Book, the terms of the ASSA ABLOY ACCENTRA® Price Book shall govern.

### **Dispute Resolution**

All disputes, controversies, claims or differences which may arise between the parties out of or in relation to the purchase of Goods covered by any invoice or otherwise made by purchaser from ASSA ABLOY ACCENTRA® (including questions as to whether a matter is governed by this arbitration provision) shall be solely and exclusively settled by binding arbitration conducted in accordance with the American Arbitration Association (AAA) Rules. All hearings and proceedings regarding arbitration shall take place in Berlin, Connecticut. All disputes involving less than \$250,000 shall be heard by a single arbitrator, and all other disputes shall be heard by panel of three

arbitrators. The arbitrators shall be selected in a manner as set forth by the AAA. Reasonable discovery shall be allowed. The costs and fees of the arbitration shall be allocated by the arbitrators. The award rendered by the arbitrators shall be final and binding upon the parties, and judgement may be entered and enforced in accordance with applicable law in any court having jurisdiction thereof. The resolution of the arbitration shall be kept confidential by the parties and the arbitrators. Nothing herein shall bar the right of either party to obtain injunctive relief against conduct that will cause irreparable loss or damages under rules of equity. The parties hereby consent to jurisdiction in any court in the State of Connecticut with respect to the enforcement of any arbitration award or injunctive or other judicial relief.

### **Changes or Cancellations**

Any item additions, quantity changes or specification changes made to accepted orders will generate a new acknowledgment for the entire order and a new shipment date. All sales are final. Quantity reductions or cancellations are accepted only with prior written consent at least 2 weeks prior to the scheduled shipment date. Cancellations or reductions after 2 business days of acknowledgement may be subject to a 45% fee. We may without liability cancel any accepted order before shipment if our credit department does not approve your credit.

### **Programs**

All support programs related to the business are only applicable to customers whose account is current and in good standing.

### **Customer Service**

**ASSA ABLOY ACCENTRA®, Customer Service Department**  
225 Episcopal Road, Berlin, CT 06037 USA  
Tel 1-855-686-2204 | Fax 1-800-338-0965

Customer service department hours are between 8:00 am and 4:30 pm EST, Monday through Friday, except holidays.

# ASSA ABLOY ACCENTRA® TERMS AND CONDITIONS OF SALE



## EXPORT CONTROL AND SANCTIONS

1.1 The Customer represents and warrants to ASSA ABLOY ACCENTRA® that it will always act in compliance with Economic Sanctions and Export Control Laws, and that:

- a) neither the Customer, its affiliates, or any of their respective directors, officers, employees nor, so far as the Customer is aware, any agents or other persons acting on behalf of any of the foregoing:
  - I. is, or has been, a Listed Person;
  - II. has engaged in any business dealings or activities that would reasonably be expected to result in it becoming a Listed Person;
  - III. directly or indirectly, has conducted or is conducting any business dealings or activities with or for the benefit of, or is otherwise involved in any business with a Listed Person, or otherwise acting in violation of Economic Sanctions and Export Control Laws;
  - IV. has engaged or is engaging in any transaction that circumvents, evades or avoids, or has the purpose or effect of circumventing, evading or avoiding, or attempts to violate, any Economic Sanctions and Export Control Laws; or
  - V. is, or has been, in violation of, or subject to, any investigation or enquiry by, or on behalf of, any governmental or other regulatory body relating to Economic Sanctions and Export Control Laws.
- b) the Customer shall act in compliance with Economic Sanctions and Export Control Laws, and shall not sell nor re-export the Product without all requisite licenses and approvals under Economic Sanctions and Export Control Laws;
- c) the Customer shall not sell, export or re-export, the Product, directly or indirectly, to the Russian Federation or Belarus or for use in the Russian Federation or Belarus (whether or not permitted under Economic Sanctions and Export Control Laws applicable to the Customer);
- d) the Customer shall undertake its best efforts to ensure that the purpose of this Clause is not frustrated by any third parties further down the commercial chain, including by possible resellers;
- e) the Customer agrees to (i) cascade the contractual obligations set forth in this Section 1.1. in contracts with third parties, including possible resellers, further down the commercial chain.; and (ii) set up and maintain an adequate monitoring mechanism to detect conduct by any third parties further down the commercial chain, including by possible resellers, that would frustrate the purpose of this Section 1.1.;
- f) the representations and warranties set forth in this Section 1.1 above shall always remain true and correct;
- g) the Customer will provide written notice to ASSA ABLOY ACCENTRA® as promptly as possible and in any event within five business days, if (i) any representation or warranty should cease to be true at any time., or (ii) the Customer should encounter any problems in applying paragraphs b)- e) in this Section 1.1 above, including any relevant activities by third parties that could frustrate the purpose of said paragraphs b)- e); and
- h) the Customer will not engage in any transaction for Military End-Use unless explicitly approved in writing by ASSA ABLOY ACCENTRA®.

The Customer will provide all information relating to requests for Products that the Customer suspects could violate or circumvent Economic Sanctions and Export Control Laws, including requests from or on behalf of a Listed Person, and other attempts to acquire ASSA ABLOY ACCENTRA® products in violation of Economic Sanctions and Export Control Laws. The Customer will, to the best of its abilities, cooperate with ASSA ABLOY ACCENTRA® to facilitate compliance with Economic Sanctions and Export Control Laws and will upon ASSA ABLOY ACCENTRA®'s request provide ASSA ABLOY ACCENTRA® with true, complete and correct copies of all documentation relating to any

business dealings involving the Product, including but not limited to, end-user certifications, information concerning compliance with the obligations under above paragraphs b)- e) in this Section 1.1, and other information as may be required by ASSA ABLOY ACCENTRA® within two weeks of the simple request of such information.

- 1.2 ASSA ABLOY ACCENTRA® shall not be obliged to make any payment or take any other action if ASSA ABLOY ACCENTRA® believes in good faith that such action may constitute a violation, contribute to a violation, or constitute a circumvention of any Economic Sanctions and Export Control Laws.
- 1.3 This agreement may be terminated immediately by ASSA ABLOY ACCENTRA® by written notice to the Customer if:
  - (a) the Customer fails to provide any notice required under this Section 1.1 above, or should ASSA ABLOY ACCENTRA® determine, in its sole discretion, that any representation or warranty set forth in Section 1.1 above has failed to be true and correct at any time;
  - (b) the Customer has misrepresented or failed to properly disclose any material fact, or to provide any documentation, certifications or information requested by ASSA ABLOY ACCENTRA®; or,
  - (c) either party's ability to fulfil an obligation under this agreement is materially affected by the imposition of restrictions in Economic Sanctions and Export Control Laws.

1.4 Upon any such termination, this agreement and all rights and obligations hereunder shall immediately terminate, provided that the Customer shall remain liable to ASSA ABLOY ACCENTRA® for any breach of its obligations hereunder. 1.5 The Customer shall indemnify ASSA ABLOY ACCENTRA® and its affiliates, directors, officers, employees, advisors, agents and holders of its equity interests (collectively, "Indemnitees") against, and shall hold each Indemnitee harmless from, any and all third party claims, damages and liabilities, including the reasonable fees, charges and disbursements of counsel, incurred by or asserted against any Indemnitee arising out of, in connection with, or as a result of (a) any representation or warranty set forth in Section 1.1 above not being true and correct when made, (b) any breach by the Supplier of any obligation under Section 1.1 or 1.2 above, or (c) any claim, litigation, investigation or proceeding relating to any of the foregoing, whether based on contract, tort or any other theory. This indemnity shall survive the termination of this agreement indefinitely.

For the purposes of this part of the agreement under the heading "Export Control and Sanctions",

**"Economic Sanctions and Export Control Laws"** means all economic sanctions and export control laws, regulations, rules or restrictive measures, including but not limited to import and export restrictions on materials, intellectual property, other intangible personal property, services, items and transactions, adopted and enforced by governmental authorities of Canada, the EU, UK, UN, USA or any other relevant governmental or regulatory authority, applicable to the ASSA ABLOY ACCENTRA® or the Customer.

"Listed Person" means individuals and entities listed, or parties that are determined to be owned or controlled by one or more individuals or entities listed, in Economic Sanctions and Export Control Laws.

Compliance with Anti-Trust, Anti-Corruption and Data Privacy Laws:

The Customer, its directors, officers, and employees shall perform their obligations under these Terms and Conditions in full compliance with the ASSA ABLOY Code of Conduct which is accessible online at: [Our Code of Conduct for business partners | ASSA ABLOY](#)

[Click this Link](#) to Export Control and Sanctions for Canada.



# ORDERING INFORMATION

**FINISH:** Indicate by using the BHMA designation of the names, listed on price pages.

BHMA	Description
605	Bright Brass, Clear Coated
609	Antique Brass
613E	Dark Oxidized Satin Bronze-equivalent
10BP	Oil Rubbed Bronze Permanent
619	Satin Nickel Plated, Clear Coated
620	Antique Nickel
625	Bright Chrome Plated
626	Satin Chrome Plated
BSP	Black Suede Powder Coat
GM	Gun Metal

**Split Finishes:** Print as stated in current price book

## 9 Description

### FUNCTION-DESIGN-FINISH-PACKAGING-HANDING

**FUNCTION:** Function numbers and descriptions are noted with each series throughout this Price Book.

**DESIGN:** Indicate by using the two letter designation of the names, listed on price pages.

**FINISH CODES:** see above.

**PACKAGING:** All locks are shipped Box Packed as standard unless otherwise specified. SP: Box Packed (Standard Packed)

**BP:** Bulk Pack – Lock trim individually boxed and packed 24 per case. Latches, strikes, screws packed separately.

**HANDING:** The hand of a door is always determined by facing the outside of a door. See diagram on pages [12](#), [22](#), [33](#) for further details.

LH: If the hinge is on the left side of the door, then the door is left-handed.

RH: If the hinge is on the right side of the door, then the door is right-handed.

## 10 Decorative Rose Design

Specify decorative rose design selection. Standard rose ships unless specified.

## 11 Latch Options

Specify 2-3/8", 2-3/4", or Adjustable along with latch face type.

See Examples:

**SC** (Square Corner)

**RC** (Round Corner)

**DI** (Drive-In)

**ADJ-SC** (Adjustable Square Corner)

See pages [30](#), and [40](#) for more details.

## 12 Strike Options

Specify strike type. See page [45](#) for more details.

## 13 Specifying Keying

Keying requirements must be specified at time of order.

**KD:** Keyed Different

**KA:** Keyed Alike

**MK:** Master Keyed\* (A single master key operates all locks within the system.)

**BK:** Builder Key\* (Builder key operates all locksets within a system. Use of homeowner's key cancels the builder key.)

**BMK:** Builder Keyed and Master Keyed\* (Builder key and master key operates all locksets within a system. Use of tenants key cancels the builder key.)

**K-T-P:** Keyed To Pass (For apartment vestibules or laundry rooms. All tenant keys will operate.)

**GMK:** Grand Master Keyed\* (More than 1 master key system operated by a single master key.)

**BGMK:** Builder Keyed and Grand Master Keyed\* (Combination of BK and GMK.) \*Builder and/or master keys are sent certified mail to the "Bill To" address, referencing the purchase order number and the original order number.

## 14 Keyway / Key System Specifications

**KEYWAY:** All locks will be shipped with our Heritage Collection Grade 3 KW 5-Pin cylinder or Heritage Collection Grade 2 6-Pin cylinder as standard depending upon the locks ordered. If SC keyway is specified it will ship as 5-pin standard. Para keyway will ship as 6-pin standard. See the available options sections in this Price Book.

**KEY SYSTEMS:** Note the specific key system to be used if any. This is particularly important if the order is an extension of an existing system.

## ORDERING INFORMATION

### 15 Price

---

Enter the price. NOTE: Price may be adjusted if required to correspond to published pricelist.

### 16 Buyer Signature

---

No order will be processed without an authorized signature.

### 17 ASSA ABLOY ACCENTRA® Company Representative

---

If the order is written by someone other than the authorized buyer, the full name of the person placing the order.

### Submit The Order

---

#### FAXING ORDERS

Fax number for Heritage Collection Grade 2 and Grade 3 orders:

**1-800-338-0965**

#### EMAILING ORDERS

Email all orders to:

[orders.AccentraRes@assaabloy.com](mailto:orders.AccentraRes@assaabloy.com)

# HERITAGE COLLECTION GRADE 2 TABLE OF CONTENTS



<a href="#">Interconnected</a> .....	11
<a href="#">Levers</a> .....	16
<a href="#">Knobs</a> .....	21
<a href="#">Deadbolts</a> .....	24

**HERITAGE COLLECTION GRADE 2  
INTERCONNECTED LOCKSETS  
ADJUSTABLE 4" OR 5.5"**



The Heritage Collection Grade 2 Interconnected Mechanical Locksets offer flexible, convenient and stylish security for new or retrofit multi-family applications. The center to center dimension is field-adjustable and installs into most standard door preps. From the inside, latchbolt and deadbolt retract simultaneously for easy egress and the thumbturn quickly secures the opening. Available in two functions with 14 levers in 6 finishes, the Interconnected Mechanical locksets are sure to complement any décor.

# HERITAGE COLLECTION GRADE 2 INTERCONNECTED LOCKSETS



FUNCTIONS		
FUNCTION	NO.	DESCRIPTION
	YR852	<b>PASSAGE:</b> Single point lock. Latchbolt is operated by either lever at all times. Deadbolt activated by key on outside; inside by T-turn. Interior lever retracts latch and deadbolt simultaneously.
	YR853	<b>PRIVACY WITH DEADBOLT INDICATOR:</b> Single point lock. Latchbolt is operated by either lever at all times. Deadbolt activated by emergency key on outside; inside by T-turn. Occupancy indicator displays "Occupied" when deadbolt thrown or "Vacant" when deadbolt retracted. Interior lever retracts latch and deadbolt simultaneously.

PRODUCT SPECIFICATIONS	
<b>Door Specs</b>	2-1/8" Face Bore, 1" Edge Bore, 4" or 5-1/2" Center to Center
<b>Backset</b>	2-3/8" or 2-3/4"
<b>Door Thickness</b>	1-3/8" to 1-3/4"
<b>Cylinder</b>	KW-1 standard, other cylinders/keyways available to order
<b>Keying</b>	KD (Keyed Different) standard, master keying available to order Other Keying options see page 14
<b>Latch Faceplate</b>	1" W x 2-1/4" H; Round Corner standard, Square Corner available to order
<b>Strike</b>	2-1/4 RC Full Lip & 1-1/8 x 2-3/4 RC Universal standard, Other strikes Available to order.
<b>Certified ANSI/BHMA</b>	A156.12, Grade 2
<b>UL/cUL</b>	Listed for 90 minute fire doors

DIMENSIONS	A	B	C	D	WIDTH
<b>Lever</b>	10-5/8"	2- 5/8"	2-1/2"	4" 5-1/2"	2-13/16"

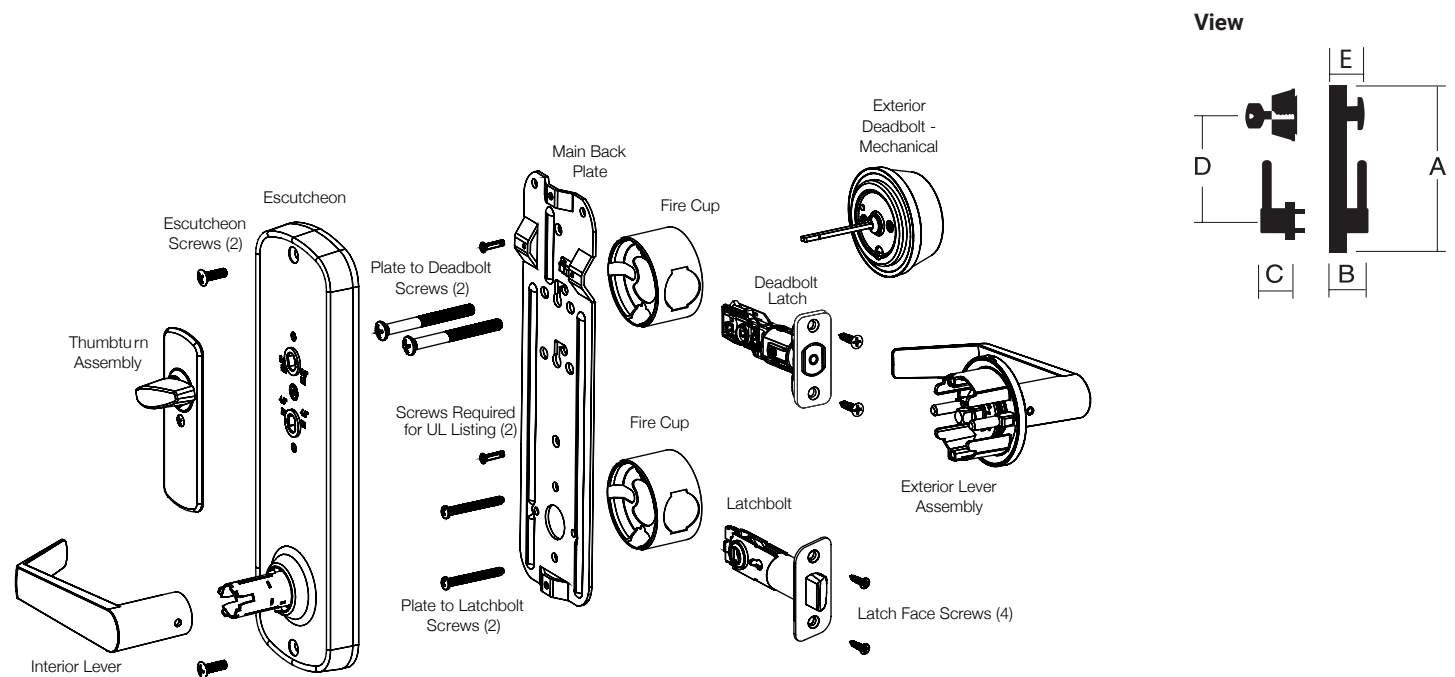

# HERITAGE COLLECTION GRADE 2 INTERCONNECTED LOCKSETS



HERITAGE COLLECTION GRADE 2									
LIST PRICE									
Interconnected	DESIGN	FUNCTION NO	605	619	BSP	626	10BE	10BP	
Available lever styles shown below. Premier Deadbolt - Standard KW, SC, Para D200 Deadbolt - GA, SFIC, Others 90 Min UL Rating Standard		BHMA			Black Suede			613E	
YR852 Single Locking All Levers	Interconnect	852	287.20	287.20	287.20	287.20	310.30	310.30	
YR853 Privacy with Indicator All Levers	Interconnect	853	287.20	287.20	287.20	287.20	310.30	310.30	



# HERITAGE COLLECTION GRADE 2 INTERCONNECTED LOCKSETS



INTERCONNECTED PASSAGE LEVER PAIRS		
Design	Part #	619 626
Academy (Passage Lever Pair)	YR05D67	41.20
Augusta (Passage Lever Pair)	YR05D66	41.20
Delaware (Passage Lever Pair)	YR05D6D	41.20
Kincaid (Passage Lever Pair)	YR05D6K	41.20
Marina (Passage Lever Pair)	YR05D64	41.20
McClure (Passage Lever Pair)	YR05D65	41.20
Milan (Passage Lever Pair)	YR05D63	41.20
Monroe (Passage Lever Pair)	YR05D6W	41.20
Norwood (Passage Lever Pair)	YR05D68	41.20
Pacific Beach (Passage Lever Pair)	YR05D62	41.20
Valdosta (Passage Lever Pair)	YR05D6V	41.20
Virgo (Passage Lever Pair)	YR05D61	41.20
Woodland (Passage Lever Pair)	YR05D69	41.20

OPTIONS		
Less Cylinder (LC)	\$0.00 No deductions	
SFIC (LC only)	\$0.00 No deductions	Lock SFICLC only. A600 or K600 available, should be listed as a separate line item. To order specify SFIC.
LFIC (LC only)	No deductions	Lock LFICLC only. 1210, 5210 or K800 core available, should be listed as a separate line item. To order specify YR852 x LFIC.
Arrow Keyway	\$0.00 No adder	To order specify "AR" keyway.
Para Keyway	\$0.00 No adder	
GA Keyway (Only)	\$0.00 No adder	Extend leadtime for BK, MK, GMK, etc.
Other Commercial keyways and Cylinder formats	\$0.00 No deductions	1. Specify less core when ordering 2. Order cylinder as a separate line item
KW1 cylinder separately 6 pin	\$12.30	See page 15 for cylinder options and part numbers.
Schlage C separately 6-pin	\$17.60	See page 15 for cylinder options and part numbers.
ASSA ABLOY ACCENTRA® Para separately 6 pin	\$17.60	See page 15 for cylinder options and part numbers.
1803-134S Cylinder separately	Includes GB - GH	Order as a separate line item
Arrow cylinders separately	See Arrow Price Book	692C x 6 pin

US and Canada Prices Effective February 2, 2026 / [Canada 2026 Tariff Price Adjustments](#)

# HERITAGE COLLECTION GRADE 2 INTERCONNECTED LOCKSETS

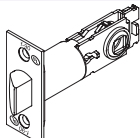

LOCKSET LATCHES							
PLAIN SPRING LATCHES	BACKSET	FRONT WIDTH	THROW	LATCH DIAMETER	CORNER SPECS	MODEL NO	LIST PRICE
	2-3/8" (60mm)	1" (25mm)	1/2" (13mm)	7/8" (22mm)	Radius	YR01802*U	14.60
	2-3/8" (60mm)	1" (25mm)	1/2" (13mm)	7/8" (22mm)	Square	YR01804*U	14.60
	2-3/4" (70mm)	1" (25mm)	1/2" (13mm)	7/8" (22mm)	Radius	YR01806*U	14.60
	2-3/4" (70mm)	1" (25mm)	1/2" (13mm)	7/8" (22mm)	Square	YR01808*U	14.60

\*Specify finish when ordering.

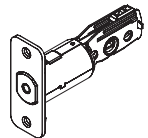
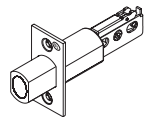
DEADBOLT LATCHES							
For use with PARA, Kwikset and Schlage C keyway cylinders (82 Deadbolt)							
	BACKSET	FRONT WIDTH	THROW	CORNER SPECS	MODEL NO	LIST PRICE	
	Adjustable <sup>A</sup>	1" (25mm)	1" (25mm)	Square	YR01D44*U	16.80	
	Adjustable <sup>A</sup>	1" (25mm)	1" (25mm)	Radius	YR01D41*U	16.80	
For use with LFIC, SFIC, Arrow and Commercial GA Keyway cylinders. (D200 Deadbolt)							
	BACKSET	FRONT WIDTH	THROW	CORNER SPECS	MODEL NO	LIST PRICE	
	2-3/8" Fixed	1" (25mm)	1" (25mm)	Square	D38*	**	
	2-3/8" Fixed	1" (25mm)	1" (25mm)	Radius	D38R*	**	
	2-3/4" Fixed	1" (25mm)	1" (25mm)	Square	D34*	**	
	2-3/4" Fixed	1" (25mm)	1" (25mm)	Radius	D34R*	**	

\*Specify finish when ordering.

<sup>A</sup>2-3/8" to 2-3/4" (60mm to 70mm).

FIXED CORE CYLINDERS				
KEYWAY	DESCRIPTION		NUMBER OF PINS	LIST PRICE
Kwikset <sup>®</sup>	Standard Cylinder. Available 1-Bitted, KA, KD (Std), MK, BK	YR06D103ICN (605) YR06D106ICN (626)	6	11.70
PARA	Optional Cylinder. Available 0-Bitted, KD, KA, MK, BK	YR06Y413ICN (605) YR06Y416ICN (626)	6	16.80
GA	Optional Cylinder. Available 0-Bitted, KD, KA, MK, CMK Extend Leadtime For BK, MK, GMK, Etc.	1803-134S	6	**
Arrow AR	Optional Cylinder. Available KA, KD	692C	6	Order through Arrow Manufacturing
Schlage <sup>®</sup> C	Optional Cylinder. Available 0-Bitted, KD, KA, MK, BK	YR068D02ICN (605) YR068D06ICN (626)	6	16.80

605 finish cylinders used with 605, 613E and 10BP finish locks. 626 finish cylinders used with 619, 626, BSP finish locks.

Specify finish and keying when ordering cylinders separately.

Note: Other ASSA ABLOY ACCENTRA<sup>®</sup> Commercial keyways and cylinder mechanisms available separately. Contact customer service for availability.

### INTERCHANGEABLE CORE

**Small Format** – Small format interchangeable core is available. To order, specify "x SFIC-LC" for cylinder. i.e. AU x YR852 x SFIC-LC x 4" x 626. All units will be provided less core. Model number A600 or K600 cores can be ordered separately.

**Large Format** – ASSA ABLOY ACCENTRA<sup>®</sup> Commercial large format interchangeable core is available for passage function. To order, specify "x LFIC-LC" for cylinder. i.e. AU x YR852 x LFIC-LC x 4" x 626. All units will be provided less 6-pin core only. LFIC cores can be ordered separately.

# HERITAGE COLLECTION GRADE 2 LEVER LOCKSETS



Heritage Collection Grade 2 levers offer a range of designs with sculptured roses and delicately crafted curves. The “non-handed” design and strength of the interior sub-assemblies allow for quick and easy installation and years of secure operation. All products in this series are ANSI Grade 2 superior light commercial quality.

<b>Academy (AC)</b> 	<b>Augusta (AU)</b> 	<b>Charleston (CH)</b> 	<b>Delaware (DW)</b> 
<b>Kincaid (KC)</b> 	<b>Kincaid Black Insert (KCB)</b> 	<b>Marina (MA)</b> 	<b>McClure (MC)</b> 
<b>Milan (MN)</b> 	<b>Monroe (MO)</b> 	<b>Norwood (NW)</b> 	<b>Pacific Beach (PB)</b> 
<b>Valdosta (VL)</b> 	<b>Valdosta (VLSQ) (Square Rose)</b> 	<b>Virgo (VG)</b> 	

Small format interchangeable core available for entry function.

# HERITAGE COLLECTION GRADE 2 LEVER LOCKSETS



FUNCTIONS		
FUNCTION	NO.	DESCRIPTION
	81	DUMMY: For doors where only pull is required. (handing required)
	11	PASSAGE: Latchbolt is operated by either lever at all times. (non-handed)
	61	ONE SIDED W/PLATE: Latchbolt is operated by lever on one side only. (handing required)
	21	PRIVACY: Latchbolt is operated by either lever except when inside lever is locked by push button. Push button is released by coin release slot on outside or by turning inside lever. (non-handed)
	22	BATHROOM: Same function as 21 privacy with 625 finish on interior lever. (handing required)
	71	ENTRY (LEVER/LEVER): Guarded latchbolt operated from outside by key; inside by lever. Push button locks outside lever. Outside lever unlocks by key or by turning inside lever. (non-handed)
	73	ENTRY (LEVER/LEVER): Guarded latchbolt operated from outside lever by key. Inside by lever. Turn button locks outside lever. Outside lever unlocks by key or turning inside turn button. (non-handed)
	74LC	ENTRY (Lever/Lever): Guarded latchbolt with SFIC cylinder operated from outside lever by key. Inside by lever. Turn button locks outside lever. Outside lever unlocks by key or turning inside turn button. (non-handed)
	76	CLASSROOM: Guarded latchbolt operated by either lever except when outside lever is locked by outside key. Inside lever is always free. (handing required)
	79	STOREROOM: ADA Guarded latchbolt operated from outside lever by key; inside by lever. Outside lever fixed until cylinder is unlocked by key. Key captured until cylinder is locked. Inside lever is always free. (handing required)

PRODUCT SPECIFICATIONS	
<b>Door Specs</b>	2-1/8" Face Bore, 1" Edge Bore, 2-3/8" or 2-3/4" Backset Latch Face 1" x 2-1/4" RC (Round corner; Square corner optional)
<b>Latch</b>	Adjustable 2-3/8" or 2-3/4" RC (Round Corner)
<b>Door Thickness</b>	1-3/8" to 1-3/4"
<b>Cylinder</b>	6 Pin KW-1 Standard (SC-1 Optional)
<b>Keying</b>	KA3 (Keyed Alike)
<b>Faceplate</b>	1" W x 2-1/4" H RC (Round Corner)
<b>Strike</b>	2-1/4" Full Lip RC (Round Corner)
<b>Certified ANSI/BHMA</b>	A156.2 Series 4000 Grade 2 A156.39 Grade A

DIMENSIONS	A	B	C
<b>Academy</b>	2-9/16"	2-7/16"	4-19/64"
<b>Augusta</b>	2-9/16"	2-1/2"	4-3/4"
<b>Charleston</b>	2-9/16"	2-1/2"	5-3/8"
<b>Delaware</b>	2-9/16"	2-3/4"	4-5/8"
<b>Kincaid</b>	2-9/16"	2-7/16"	4-1/2"
<b>Kincaid Black Insert</b>	2-9/16"	2-7/16"	4-1/2"
<b>Marina</b>	2-9/16"	3 5/16"	4-7/8"
<b>McClure</b>	2-9/16"	2-7/16"	4-3/16"
<b>Milan</b>	2-9/16"	2-7/16"	4-1/16"
<b>Monroe</b>	2-9/16"	2-7/16"	4-5/8"
<b>Norwood</b>	2-9/16"	2-1/2"	4-7/32"
<b>Pacific Beach</b>	2-9/16"	2-7/16"	4 3/4"
<b>Valdosta</b>	2-9/16"	2-1/2"	4-5/8"
<b>Virgo</b>	2-9/16"	2-9/16"	4-1/2"

Standard Case Quantities - Enter the exact number of individual units required. As an example: If there are 24 units in a case and you require 1 case, enter 24 in the "quantity" space. See below for an example of standard case quantities.

STANDARD CASE QUANTITIES	QUANTITY
<b>Levers</b>	12

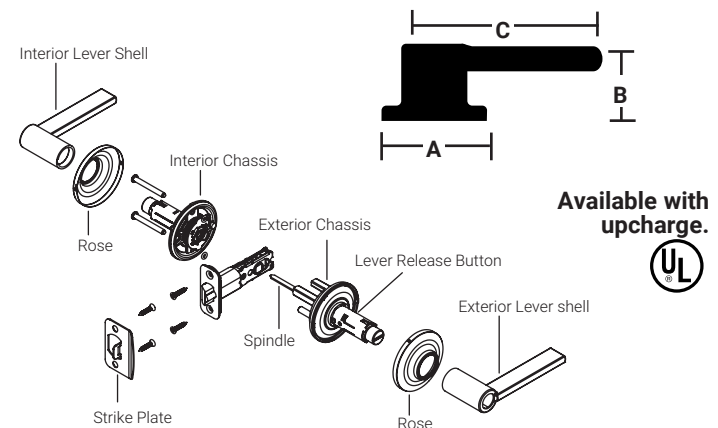

# HERITAGE COLLECTION GRADE 2 LEVER LOCKSETS

## DECORATIVE ROSES

**Oval** 2-9/16" W x 4-7/32" H  
Center Hole: Knob 15/16" – Lever 1-1/32"

**Traditional** 2-9/16" W x 4-7/32" H  
Center Hole: Knob 15/16" – Lever 1-1/32"

**Modern** 2-9/16" W x 3" H  
Center Hole: 1-1/32"

**Flat Round** 2-9/16" Dia  
Center Hole: 1-1/32"

**Flat Square** 2-9/16" W x 2-9/16" H  
Center Hole: 1-1/32"

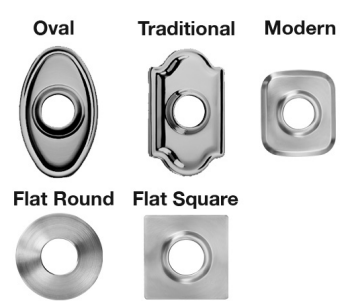

PAIR WITH ALL HERITAGE COLLECTION GRADE 2 LEVER DESIGNS.

Roses Availability	605	10BP	619	BSP	625	626	List Upcharge	
							Full Lockset	Dummy
Oval	•	•	•				22.90	11.50
Traditional	•	•	•				22.90	11.50
Modern		•	•	•			18.30	9.20
Flat Round		•	•	•	•	•	11.50	5.80
Flat Square		•	•	•	•	•	18.30	9.20

Note: Decorative roses ship separate as kit.

LIST PRICE Featuring Push Button Locking with Free Interiors												
DESIGN	FUNCTION BHMA	NO	605	625	626	609	619	620	GM Gun Metal	BSP Black Suede	613E	US10BP
Academy (AC)	Dummy	81	N/A	N/A	31.10	31.10	31.10	N/A	N/A	N/A	N/A	N/A
	Passage	11	N/A	N/A	72.90	72.90	72.90	N/A	N/A	N/A	N/A	N/A
	One Sided w/plate	61	N/A	N/A	72.90	72.90	72.90	N/A	N/A	N/A	N/A	N/A
	Privacy**	21	N/A	N/A	77.80	77.80	77.80	N/A	N/A	N/A	N/A	N/A
	Entry (Lever/Lever)**	71	N/A	N/A	120.70	120.70	120.70	N/A	N/A	N/A	N/A	N/A
	Entry (T - Turn)	73	N/A	N/A	120.70	120.70	120.70	N/A	N/A	N/A	N/A	N/A
	Classroom	76	N/A	N/A	120.70	120.70	120.70	N/A	N/A	N/A	N/A	N/A
	Storeroom	79	N/A	N/A	120.70	120.70	120.70	N/A	N/A	N/A	N/A	N/A
Augusta (AU)	Dummy	81	32.20	N/A	32.20	32.20	32.20	N/A	N/A	N/A	33.30	33.30
	Passage	11	77.10	N/A	77.10	77.10	77.10	N/A	N/A	N/A	79.30	79.30
	One Sided w/plate	61	77.10	N/A	77.10	77.10	77.10	N/A	N/A	N/A	79.30	79.30
	Privacy**	21	86.30	N/A	86.30	86.30	86.30	N/A	N/A	N/A	88.50	88.50
	Entry (Lever/Lever)**	71	129.90	N/A	129.90	129.90	129.90	N/A	N/A	N/A	132.10	132.10
	Entry (T - Turn)	73	129.90	N/A	129.90	129.90	129.90	N/A	N/A	N/A	132.10	132.10
	Entry SFIC	74LC	129.90	N/A	129.90	129.90	129.90	N/A	N/A	N/A	132.10	132.10
	Classroom	76	129.90	N/A	129.90	129.90	129.90	N/A	N/A	N/A	132.10	132.10
Storeroom	79	129.90	N/A	129.90	129.90	129.90	N/A	N/A	N/A	132.10	132.10	
Charleston (CH)	Dummy	81	N/A	N/A	32.20	N/A	32.20	N/A	N/A	32.20	33.30	N/A
	Passage	11	N/A	N/A	77.10	N/A	77.10	N/A	N/A	77.10	79.30	N/A
	One Sided w/plate	61	N/A	N/A	77.10	N/A	77.10	N/A	N/A	77.10	79.30	N/A
	Privacy**	21	N/A	N/A	86.30	N/A	86.30	N/A	N/A	86.30	88.50	N/A
	Entry (Lever/Lever)**	71	N/A	N/A	129.90	N/A	129.90	N/A	N/A	129.90	132.10	N/A
	Entry (T - Turn)	73	N/A	N/A	129.90	N/A	129.90	N/A	N/A	129.90	132.10	N/A
	Classroom	76	N/A	N/A	129.90	N/A	129.90	N/A	N/A	129.90	132.10	N/A
	Storeroom	79	N/A	N/A	129.90	N/A	129.90	N/A	N/A	129.90	132.10	N/A
Delaware (DW)	Dummy	81	N/A	32.20	32.20	N/A	32.20	N/A	N/A	32.20	33.30	34.40
	Passage	11	N/A	77.10	77.10	N/A	77.10	N/A	N/A	77.10	79.30	79.30
	One Sided w/plate	61	N/A	77.10	77.10	N/A	77.10	N/A	N/A	77.10	79.30	79.30
	Privacy**	21	N/A	86.30	86.30	N/A	86.30	N/A	N/A	86.30	88.50	88.50
	Bath*	22	N/A	89.60	89.60	N/A	89.60	N/A	N/A	89.60	92.00	92.00
	Entry (Lever/Lever)**	71	N/A	129.90	129.90	N/A	129.90	N/A	N/A	129.90	132.10	132.10
	Entry (T - Turn)	73	N/A	129.90	129.90	N/A	129.90	N/A	N/A	129.90	132.10	132.10
	Classroom	76	N/A	129.90	129.90	N/A	129.90	N/A	N/A	129.90	132.10	132.10
Storeroom	79	N/A	129.90	129.90	N/A	129.90	N/A	N/A	129.90	132.10	132.10	
Kincaid (KC)	Dummy	81	37.60	N/A	37.60	N/A	37.60	N/A	N/A	37.60	N/A	N/A
	Passage	11	86.30	N/A	86.30	N/A	86.30	N/A	N/A	86.30	N/A	N/A
	One Sided w/plate	61	86.30	N/A	86.30	N/A	86.30	N/A	N/A	86.30	N/A	N/A
	Privacy**	21	90.80	N/A	90.80	N/A	90.80	N/A	N/A	90.80	N/A	N/A
	Entry (Lever/Lever)**	71	135.60	N/A	135.60	N/A	135.60	N/A	N/A	135.60	N/A	N/A
	Entry (T - Turn)	73	135.60	N/A	135.60	N/A	135.60	N/A	N/A	135.60	N/A	N/A
	Classroom	76	135.60	N/A	135.60	N/A	135.60	N/A	N/A	135.60	N/A	N/A
	Storeroom	79	135.60	N/A	135.60	N/A	135.60	N/A	N/A	135.60	N/A	N/A

\* Bath Function has 625 Polished Chrome Interior  
\*\* ADA Push Button Locking

US and Canada Prices Effective February 2, 2026 / [Canada 2026 Tariff Price Adjustments](#)

# HERITAGE COLLECTION GRADE 2 LEVER LOCKSETS



LIST PRICE Featuring Push Button Locking with Free Interiors												
DESIGN	FUNCTION BHMA	NO	605	625	626	609	619	620	GM Gun Metal	BSP Black Suede	613E	US10BP
Kincaid Black Insert (KCB)	Dummy	81	42.50	N/A	N/A	N/A	42.50	N/A	N/A	N/A	N/A	43.60
	Passage	11	109.90	N/A	N/A	N/A	109.90	N/A	N/A	N/A	N/A	112.10
	Privacy**	21	117.20	N/A	N/A	N/A	117.20	N/A	N/A	N/A	N/A	119.60
	Entry (Lever/Lever)**	71	147.10	N/A	N/A	N/A	147.10	N/A	N/A	N/A	N/A	149.40
	Classroom	76	147.10	N/A	N/A	N/A	147.10	N/A	N/A	N/A	N/A	149.40
	Storeroom	79	147.10	N/A	N/A	N/A	147.10	N/A	N/A	N/A	N/A	149.40
Marina (MA)	Dummy	81	N/A	32.20	32.20	N/A	32.20	N/A	32.20	N/A	33.30	33.30
	Passage	11	N/A	77.10	77.10	N/A	77.10	N/A	77.10	N/A	79.30	79.30
	One Sided w/plate	61	N/A	77.10	77.10	N/A	77.10	N/A	77.10	N/A	79.30	79.30
	Privacy*	21	N/A	86.30	86.30	N/A	86.30	N/A	86.30	N/A	88.50	88.50
	Bath*	22	N/A	89.60	89.60	N/A	89.60	N/A	89.60	N/A	92.00	92.00
	Entry (Lever/Lever)**	71	N/A	129.90	129.90	N/A	129.90	N/A	129.90	N/A	132.10	132.10
	Entry (T - Turn)	73	N/A	129.90	129.90	N/A	129.90	N/A	129.90	N/A	132.10	132.10
	Classroom	76	N/A	129.90	129.90	N/A	129.90	N/A	129.90	N/A	132.10	132.10
Storeroom	79	N/A	129.90	129.90	N/A	129.90	N/A	113.00	N/A	115.00	115.00	
McClure (MC)	Dummy	81	31.10	N/A	31.10	N/A	31.10	31.10	N/A	N/A	32.20	32.20
	Passage	11	72.90	N/A	72.90	N/A	72.90	72.90	N/A	N/A	75.20	75.20
	One Sided w/plate	61	72.90	N/A	72.90	N/A	72.90	72.90	N/A	N/A	75.20	75.20
	Privacy**	21	77.80	N/A	77.80	N/A	77.80	77.80	N/A	N/A	80.20	80.20
	Entry (Lever/Lever)**	71	120.70	N/A	120.70	N/A	120.70	120.70	N/A	N/A	122.90	122.90
	Entry (T - Turn)	73	120.70	N/A	120.70	N/A	120.70	120.70	N/A	N/A	122.90	122.90
	Classroom	76	120.70	N/A	120.70	N/A	120.70	120.70	N/A	N/A	122.90	122.90
	Storeroom	79	120.70	N/A	120.70	N/A	120.70	120.70	N/A	N/A	122.90	122.90
Milan (MN)	Dummy	81	31.10	31.10	31.10	N/A	31.10	N/A	N/A	N/A	N/A	N/A
	Passage	11	72.90	72.90	72.90	N/A	72.90	N/A	N/A	N/A	N/A	N/A
	One Sided w/plate	61	72.90	72.90	72.90	N/A	72.90	N/A	N/A	N/A	N/A	N/A
	Privacy**	21	77.80	77.80	77.80	N/A	77.80	N/A	N/A	N/A	N/A	N/A
	Bath*	22	81.20	81.20	81.20	N/A	81.20	N/A	N/A	N/A	N/A	N/A
	Entry (Lever/Lever)**	71	120.70	120.70	120.70	N/A	120.70	N/A	N/A	N/A	N/A	N/A
	Entry (T - Turn)	73	120.70	120.70	120.70	N/A	120.70	N/A	N/A	N/A	N/A	N/A
	Classroom	76	120.70	120.70	120.70	N/A	120.70	N/A	N/A	N/A	N/A	N/A
Storeroom	79	120.70	120.70	120.70	N/A	120.70	N/A	N/A	N/A	N/A	N/A	
Monroe (MO)	Dummy	81	32.20	N/A	32.20	N/A	32.20	N/A	N/A	32.20	33.30	N/A
	Passage	11	77.10	N/A	77.10	N/A	77.10	N/A	N/A	77.10	79.30	N/A
	One Sided w/plate	61	77.10	N/A	77.10	N/A	77.10	N/A	N/A	77.10	79.30	N/A
	Privacy**	21	86.30	N/A	86.30	N/A	86.30	N/A	N/A	86.30	88.50	N/A
	Entry (Lever/Lever)**	71	129.90	N/A	129.90	N/A	129.90	N/A	N/A	129.90	132.10	N/A
	Entry (T - Turn)	73	129.90	N/A	129.90	N/A	129.90	N/A	N/A	129.90	132.10	N/A
	Classroom	76	129.90	N/A	129.90	N/A	129.90	N/A	N/A	129.90	132.10	N/A
	Storeroom	79	129.90	N/A	129.90	N/A	129.90	N/A	N/A	129.90	132.10	N/A
Norwood (NW)	Dummy	81	31.10	31.10	31.10	31.10	31.10	31.10	31.10	31.10	32.20	32.20
	Passage	11	72.90	72.90	72.90	72.90	72.90	72.90	72.90	72.90	75.20	75.20
	One Sided w/plate	61	72.90	72.90	72.90	72.90	72.90	72.90	72.90	72.90	75.20	75.20
	Privacy**	21	77.80	77.80	77.80	77.80	77.80	77.80	77.80	77.80	80.20	80.20
	Bath*	22	81.20	81.20	81.20	81.20	81.20	81.20	81.20	81.20	83.50	83.50
	Entry (Lever/Lever)**	71	120.70	120.70	120.70	120.70	120.70	120.70	120.70	120.70	122.90	122.90
	Entry (T - Turn)	73	120.70	120.70	120.70	120.70	120.70	120.70	120.70	120.70	122.90	122.90
	Classroom	76	120.70	120.70	120.70	120.70	120.70	120.70	120.70	120.70	122.90	122.90
Storeroom	79	120.70	120.70	120.70	120.70	120.70	120.70	120.70	120.70	122.90	122.90	
Pacific Beach (PB)	Dummy	81	32.20	32.20	32.20	32.20	32.20	N/A	N/A	N/A	33.30	N/A
	Passage	11	77.10	77.10	77.10	77.10	77.10	N/A	N/A	N/A	79.30	N/A
	One Sided w/plate	61	77.10	77.10	77.10	77.10	77.10	N/A	N/A	N/A	79.30	N/A
	Privacy**	21	86.30	86.30	86.30	86.30	86.30	N/A	N/A	N/A	88.50	N/A
	Bath*	22	89.60	89.60	89.60	89.60	89.60	N/A	N/A	N/A	92.00	N/A
	Entry (Lever/Lever)**	71	129.90	129.90	129.90	129.90	129.90	N/A	N/A	N/A	132.10	N/A
	Entry (T - Turn)	73	129.90	129.90	129.90	129.90	129.90	N/A	N/A	N/A	132.10	N/A
	Classroom	76	129.90	129.90	129.90	129.90	129.90	N/A	N/A	N/A	132.10	N/A
Storeroom	79	129.90	129.90	129.90	129.90	129.90	N/A	N/A	N/A	132.10	N/A	

\* Bath Function has 625 Polished Chrome Interior  
\*\* ADA Push Button Locking

# HERITAGE COLLECTION GRADE 2 LEVER LOCKSETS



LIST PRICE Featuring Push Button Locking with Free Interiors												
DESIGN	FUNCTION	NO	605	625	626	609	619	620	GM Gun Metal	BSP Black Suede	613E	US10BP
Valdosta (VL)	Dummy	81	N/A	32.20	32.20	N/A	32.20	N/A	N/A	32.20	33.30	33.30
	Passage	11	N/A	77.10	77.10	N/A	77.10	N/A	N/A	77.10	79.30	79.30
	One Sided w/plate	61	N/A	77.10	77.10	N/A	77.10	N/A	N/A	77.10	79.30	79.30
	Privacy**	21	N/A	86.30	86.30	N/A	86.30	N/A	N/A	86.30	88.50	88.50
	Bath*	22	N/A	89.60	89.60	N/A	89.60	N/A	N/A	89.60	92.00	92.00
	Entry (Lever/Lever)**	71	N/A	129.90	129.90	N/A	129.90	N/A	N/A	129.90	132.10	132.10
	Entry (T - Turn)	73	N/A	129.90	129.90	N/A	129.90	N/A	N/A	129.90	132.10	132.10
	Classroom	76	N/A	129.90	129.90	N/A	129.90	N/A	N/A	129.90	132.10	132.10
Valdosta SQR Rose (VLSQ)	Storeroom	79	N/A	129.90	129.90	N/A	129.90	N/A	N/A	129.90	132.10	132.10
	Dummy	81	N/A	41.60	41.60	N/A	41.60	N/A	N/A	41.60	N/A	N/A
	Passage	11	N/A	95.30	95.30	N/A	95.30	N/A	N/A	95.30	N/A	N/A
	One Sided w/plate	61	N/A	95.30	95.30	N/A	95.30	N/A	N/A	95.30	N/A	N/A
	Privacy**	21	N/A	104.50	104.50	N/A	104.50	N/A	N/A	104.50	N/A	N/A
	Bath*	22	N/A	107.50	107.50	N/A	107.50	N/A	N/A	107.50	N/A	N/A
	Entry (Lever/Lever)**	71	N/A	148.00	148.00	N/A	148.00	N/A	N/A	148.00	N/A	N/A
	Entry (T - Turn)	73	N/A	148.00	148.00	N/A	148.00	N/A	N/A	148.00	N/A	N/A
Virgo (VG)	Classroom	76	N/A	148.00	148.00	N/A	148.00	N/A	N/A	148.00	N/A	N/A
	Storeroom	79	N/A	148.00	148.00	N/A	148.00	N/A	N/A	148.00	N/A	N/A
	Dummy	81	31.10	31.10	31.10	N/A	31.10	31.10	N/A	31.10	32.20	32.20
	Passage	11	72.90	72.90	72.90	N/A	72.90	72.90	N/A	72.90	75.20	75.20
	One Sided w/plate	61	72.90	72.90	72.90	N/A	72.90	72.90	N/A	72.90	75.20	75.20
	Privacy**	21	77.80	77.80	77.80	N/A	77.80	77.80	N/A	77.80	80.20	80.20
	Bath*	22	N/A	N/A	N/A	N/A	N/A	81.20	N/A	N/A	83.50	83.50
	Entry (Lever/Lever)**	71	120.70	120.70	120.70	N/A	120.70	120.70	N/A	120.70	122.90	122.90
Entry (T - Turn)	73	120.70	120.70	120.70	N/A	120.70	120.70	N/A	120.70	122.90	122.90	
Classroom	76	120.70	120.70	120.70	N/A	120.70	120.70	N/A	120.70	122.90	122.90	
Storeroom	79	120.70	120.70	120.70	N/A	120.70	120.70	N/A	120.70	122.90	122.90	

\* Bath Function has 625 Polished Chrome Interior  
\*\* ADA Push button locking

AVAILABLE OPTIONS		LIST PRICE UPCHARGE
Roses - Traditional, Oval	Full Lockset	22.90
Roses - Traditional, Oval	Dummy	11.50
Roses - Flat Round	Full Lockset	11.50
Roses - Flat Round	Dummy	5.80
Roses - Flat Square & Modern	Full Lockset	18.30
Roses - Flat Square & Modern	Dummy	9.20
Accessory Stemmed Dummy Plate (allows a Dummy with Stems to be created from 2 Standard Dummy Trims)	YR073003	6.90
	UL 90 Minute listing	6.90
	UL 90 Minute listing	Combo Sets

### How To Determine Handing Of Doors

- The handing of a door is always determined by facing the exterior of a door.
- If the hinge is on the left side of the door, the door is left handed (LH).
- If the hinge is on the right side of the door, the door is right handed (RH).
- To order a handed product, specify LH or RH. Not all products are handed; only specify handing when required.



Storeroom, Classroom, Dummies, and Interior Packs require handing



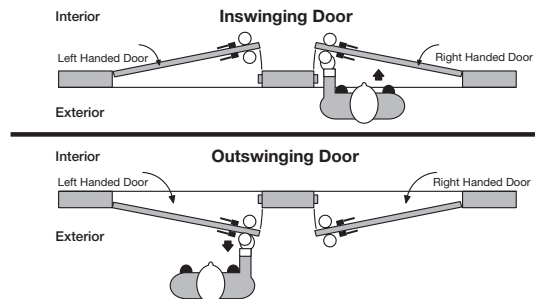

AVAILABLE OPTIONS	LIST PRICE UPCHARGE
<b>Page 27</b> Grade 2 Latches	NC when specified
<b>Page 45</b> T-Strikes	1.70
<b>Page 45</b> ANSI 4-7/8" Strike	7.60
<b>Page 45</b> Other Lockset Strikes	NC when specified
<b>Page 46</b> Additional keying options	
<b>Page 47</b> Para cylinder options	3.40
GA Keyway (allow for extended lead time)	Add \$20.00
Extension Kit 2 to 2-1/4" Heritage Collection Grade 2 Knobs/Levers (Passage) # YR076100	6.00 (specify finish)

**NOTE:** Heritage Collection Grade 2 levers are designed to be reversible to eliminate handing (except for the single dummy, Function #81, and entry functions (Function #72). For the single dummy (Function #81) and entry functions (Function #72), please specify handing either right hand (RH) or left hand (LH) when ordering these functions, or when ordering split finishes.



## HERITAGE COLLECTION GRADE 2 KNOB LOCKSET

The Heritage Collection Grade 2 continues a legacy of distinctive design, high manufacturing standards and demanding performance. The Heritage Collection Grade 2 leverages years of engineering refinement with artful execution to offer a series of ANSI Grade 2 superior light commercial quality locks that will beautifully serve any home for generations. They offer superior functionality such as push-button locking and removable knobs for simple re-keying.

Bridgeport (BP)	Dartmouth (DM)
	
Cambridge (CB)	Oxford (XF)
	

# HERITAGE COLLECTION GRADE 2 KNOB LOCKSET

FUNCTIONS		
FUNCTION	NO.	DESCRIPTION
	80	DUMMY: For doors where only pull is required.
	10	PASSAGE: Latchbolt is operated by either knob at all times.
	60	ONE SIDED W/PLATE: Latchbolt is operated by knob on one side only.
	20	PRIVACY: Latchbolt is operated by either knob except when inside knob is locked by push button. Push button is released by special emergency key on outside or by turning inside knob.
	26	BATHROOM: Same function as 20 privacy with 625 finish on interior knob.
	70	ENTRY: Guarded latchbolt operated from outside by key; inside by knob. Push button locks outside knob. Outside knob unlocks by key or by turning inside knob.
	75	CLASSROOM: Guarded latchbolt operated by either knob except when outside knob is locked by out side key. Inside knob is always free.
	78	STOREROOM: Guarded latchbolt operated from outside knob by key; inside by knob. Outside knob fixed until cylinder is unlocked by key. Key captured until cylinder is locked. Inside knob is always free.

PRODUCT SPECIFICATIONS	
<b>Door Specs</b>	2-1/8" Face Bore, 1" Edge Bore, 2-3/8" or 2-3/4" Backset Latch Face 1" x 2-1/4" RC (Round corner; Square corner optional)
<b>Latch</b>	Adjustable 2-3/8" to 2-3/4" RC (Round Corner)
<b>Door Thickness</b>	1-3/8" to 1-3/4"
<b>Cylinder</b>	6 Pin KW-1 Standard (SC-1 Optional)
<b>Keying</b>	KA3 (Keyed Alike)
<b>Faceplate</b>	1" W x 2-1/4" H RC (Round Corner)
<b>Strike</b>	2-1/4" Full Lip RC (Round Corner)
<b>Certified ANSI/BHMA</b>	A156.39 Grade A

Standard Case Quantities - Enter the exact number of individual units required. As an example: If there are 24 units in a case and you require 1 case, enter 24 in the "quantity" space. See below for an example of standard case quantities.

STANDARD CASE QUANTITIES	
	Quantity
<b>Knobs</b>	24

DIMENSIONS	A	B	C
<b>Bridgeport</b>	2-9/16"	2-9/16"	2"
<b>Oxford</b>	2-9/16"	2-1/4"	2-1/8"
<b>Cambridge</b>	2-9/16"	2-1/4"	2-5/64"
<b>Dartmouth</b>	2-9/16"	2-3/8"	2-1/2"

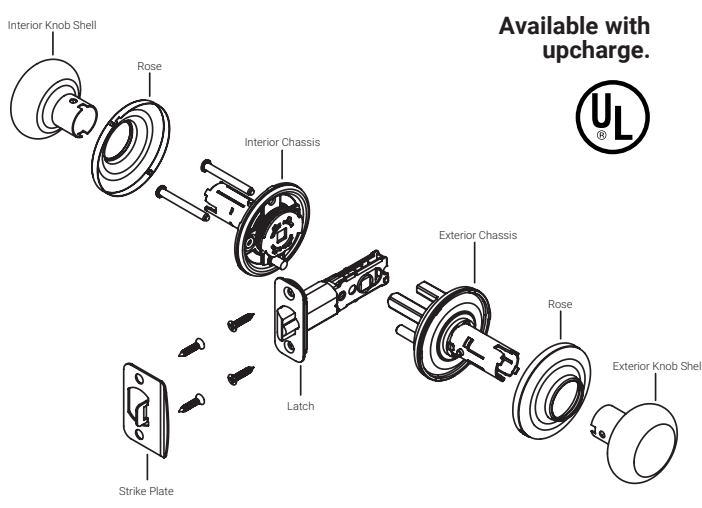
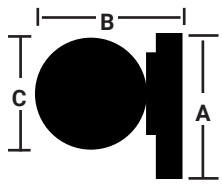

# HERITAGE COLLECTION GRADE 2 KNOB LOCKSET

## Heritage Collection Grade 2

- Oval** 2-9/16" W x 4-7/32" H  
Center Hole: Knob 15/16" – Lever 1-1/32"
- Traditional** 2-9/16" W x 4-7/32" H  
Center Hole: Knob 15/16" – Lever 1-1/32"
- Modern** 2-9/16" W x 3" H  
Center Hole: 1-1/32"
- Flat Square** 2-9/16" W x 2-9/16" H  
Center Hole: 1-1/32"

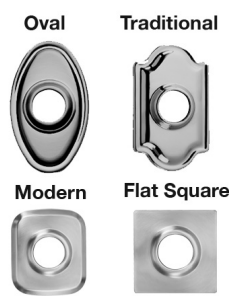

## PAIR WITH ALL HERITAGE COLLECTION GRADE 2 KNOB DESIGNS.

Roses Availability	605	10BP	619	BSP	625	626	List Upcharge	
							Full Lockset	Dummy
<b>Oval</b>	•	•	•				22.90	11.50
<b>Traditional</b>	•	•	•				22.90	11.50
<b>Modern</b>		•	•	•			18.30	9.20
<b>Flat Square</b>		•	•	•	•	•	18.30	9.20

Note: Decorative roses ship separate as kit.

## LIST PRICE Knobs Featuring Push Button Locking with Free Interiors

DESIGN	FUNCTION BHMA	NO	605	626	609	619	GM		625	620	613E	10BP
							Gun Metal	Black Suede				
Bridgeport (BP)	Dummy	80	16.70	16.70	N/A	16.70	N/A	N/A	17.80	N/A	N/A	N/A
	One Sided w/plate	60	42.10	42.10	N/A	42.10	N/A	N/A	44.30	N/A	N/A	N/A
	Passage	10	42.10	42.10	N/A	42.10	N/A	N/A	44.30	N/A	N/A	N/A
	Privacy	20	48.30	48.30	N/A	48.30	N/A	N/A	50.60	N/A	N/A	N/A
	Bath*	26	51.70	51.70	N/A	51.70	N/A	N/A	54.00	N/A	N/A	N/A
	Entry	70	80.70	80.70	N/A	80.70	N/A	N/A	83.00	N/A	N/A	N/A
	Classroom	75	80.70	80.70	N/A	80.70	N/A	N/A	83.00	N/A	N/A	N/A
	Storeroom	78	80.70	80.70	N/A	80.70	N/A	N/A	83.00	N/A	N/A	N/A
Cambridge (CB)	Dummy	80	16.70	16.70	16.70	16.70	16.70	16.70	17.80	17.80	17.80	17.80
	One Sided w/plate	60	42.10	42.10	42.10	42.10	42.10	42.10	44.30	44.30	44.30	44.30
	Passage	10	42.10	42.10	42.10	42.10	42.10	42.10	44.30	44.30	44.30	44.30
	Privacy	20	48.30	48.30	48.30	48.30	48.30	48.30	50.60	50.60	50.60	50.60
	Bath*	26	51.70	51.70	51.70	51.70	51.70	51.70	N/A	54.00	54.00	54.00
	Entry	70	80.70	80.70	80.70	80.70	80.70	80.70	83.00	83.00	83.00	83.00
	Classroom	75	80.70	80.70	80.70	80.70	80.70	80.70	83.00	83.00	83.00	83.00
	Storeroom	78	80.70	80.70	80.70	80.70	80.70	80.70	83.00	83.00	83.00	83.00
Dartmouth (DM)	Dummy	80	28.70	N/A	N/A	28.70	28.70	28.70	N/A	N/A	29.80	29.80
	One Sided w/plate	60	65.70	N/A	N/A	65.70	65.70	65.70	N/A	N/A	67.90	67.90
	Passage	10	65.70	N/A	N/A	65.70	65.70	65.70	N/A	N/A	67.90	67.90
	Privacy	20	70.80	N/A	N/A	70.80	70.80	70.80	N/A	N/A	73.00	73.00
	Entry	70	95.10	N/A	N/A	95.10	95.10	95.10	N/A	N/A	97.50	97.50
	Classroom	75	95.10	N/A	N/A	95.10	95.10	95.10	N/A	N/A	97.50	97.50
	Storeroom	78	95.10	N/A	N/A	95.10	95.10	95.10	N/A	N/A	97.50	97.50
	Oxford (XF)	Dummy	80	16.70	N/A	16.70	16.70	N/A	N/A	N/A	N/A	N/A
One Sided w/plate		60	42.10	N/A	42.10	42.10	N/A	N/A	N/A	N/A	N/A	44.30
Passage		10	42.10	N/A	42.10	42.10	N/A	N/A	N/A	N/A	N/A	44.30
Privacy		20	48.30	N/A	48.30	48.30	N/A	N/A	N/A	N/A	N/A	50.60
Entry		70	80.70	N/A	80.70	80.70	N/A	N/A	N/A	N/A	N/A	83.00
Classroom		75	80.70	N/A	80.70	80.70	N/A	N/A	N/A	N/A	N/A	83.00
Storeroom		78	80.70	N/A	80.70	80.70	N/A	N/A	N/A	N/A	N/A	83.00



\$16.90		LIST PRICE UPCHARGE
Roses - Traditional, Oval	Full Lockset	22.90
Roses - Traditional, Oval	Dummy	11.50
Roses - Flat Square & Modern	Full Lockset	18.30
Roses - Flat Square & Modern	Dummy	9.20
Accessory Stemmed Dummy Plate (allows 2 dummies to be installed on a through bored door)	073003	6.90
UL 90 Minute listing		6.90
	UL 90 Minute listing	Combo Sets

AVAILABLE OPTIONS		LIST PRICE UPCHARGE
<b>Page 27</b>	Grade 2 Latches	NC when specified
<b>Page 45</b>	T-Strikes	1.70
<b>Page 45</b>	ANSI 4 7/8" Strike	7.60
<b>Page 45</b>	Other Lockset Strikes	NC when specified
<b>Page 46</b>	Additional keying options	
<b>Page 47</b>	Para cylinder options	3.40
	GA Keyway (allow for extended lead time)	Add \$20.00
Extension Kit 2 to 2 1/4" Heritage Collection Grade 2 Knobs/Levers (Passage) # YR076100		6.00 (specify finish)



# HERITAGE COLLECTION GRADE 2 DEADBOLTS



Appreciate our focus on functionality with these finely designed Heritage Collection Grade 2 deadbolts. The Premier Deadbolt “face-removable” design provides easy access to the solid brass cylinder without having to remove the deadbolt from the door. This is a significant benefit to multi-family and multi-unit projects commonly requiring re-keying. The Select Deadbolt offers ANSI Grade 2 strength and security with standard access to the cylinder.



<p><b>82 Premier</b> Single Cylinder</p>	<p><b>83 Select</b> Single Cylinder</p>
	
<p><b>85 Select</b> Double Cylinder</p>	<p><b>87</b> One Sided with Plate</p>
	

# HERITAGE COLLECTION GRADE 2 DEADBOLTS

FUNCTIONS		
FUNCTION	NO.	DESCRIPTION
	82 83	SINGLE CYLINDER: Latch operated from outside by key, inside by T turn.
	85	DOUBLE CYLINDER: Latch operated on either side by key. Concealed screws.

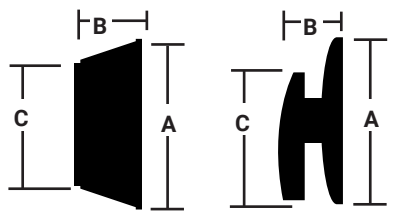
DIMENSIONS	A	B	C
<b>82 Single Exterior</b>	2-19/32"	1-1/8"	2"
<b>82 Single Interior</b>	2-1/2"	1-7/8"	2"
<b>83 Single Exterior</b>	2-1/2"	1"	1-7/8"
<b>83 Single Interior</b>	2-1/2"	1-7/8"	2"



PRODUCT SPECIFICATIONS	
<b>Door Specs</b>	2-1/8" Face Bore, 1" Edge Bore, 2-3/8" or 2-3/4" Backset Latch Face 1" x 2-1/4" RC (Round corner; Square corner optional)
<b>Latch</b>	Adjustable 2-3/8" or 2-3/4" RC (Round Corner)
<b>Door Thickness</b>	1-3/8" to 1-3/4" 2" to 2-1/4" Requires ext. Kit 07600* 83 Single Cylinder Select Series Only
<b>Cylinder</b>	6 Pin KW-1 Standard (SC-1 Optional)
<b>Keying</b>	KA3 (Keyed Alike)
<b>Faceplate</b>	1" W x 2-1/4" H RC (Round Corner)
<b>Strike</b>	1" x 2-1/4" RC RC (Round Corner)
<b>Certified ANSI/BHMA</b>	A156.36 Grade 2  A156.40 Grade B <b>Meets ADA Guidelines</b> 

Standard Case Quantities - Enter the exact number of individual units required. As an example: If there are 24 units in a case and you require 1 case, enter 24 in the "quantity" space. See below for an example of standard case quantities.

STANDARD CASE QUANTITIES	
	Quantity
Deadbolts	12

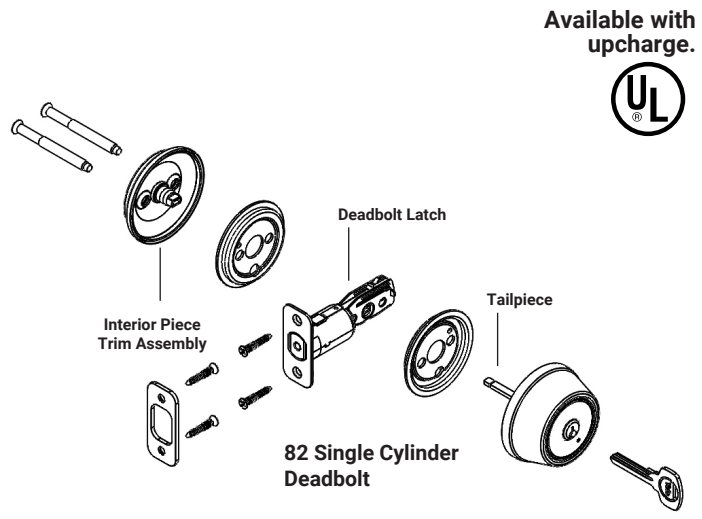
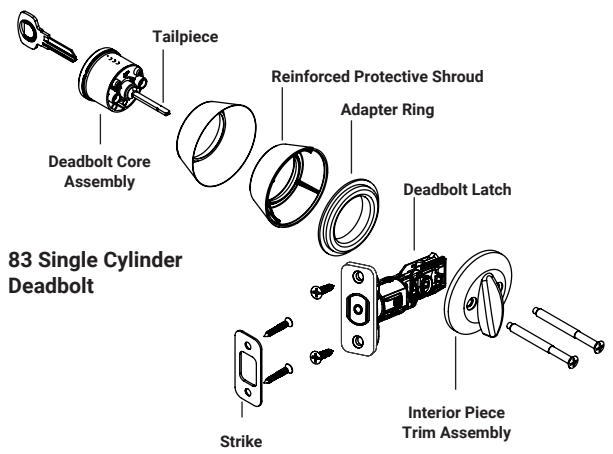

# HERITAGE COLLECTION GRADE 2 DEADBOLTS



LIST PRICE												
DESIGN	Deadbolts	NO	605	625	626	609	619	620	GM Gun Metal	BSP Black Suede	613E	10BP
Premier	Single Cyl	<b>82</b>	80.30	80.30	80.30	80.30	80.30	80.30	80.30	80.30	86.30	86.30
	Premier Series features: Removable Cylinders without removing deadbolt from door, includes high security strike.											
Select	Single Cyl	<b>83</b>	66.40	66.40	66.40	66.40	66.40	66.40	66.40	66.40	72.30	72.30
	Double Cyl	<b>85</b>	76.80	76.80	76.80	76.80	76.80	76.80	76.80	76.80	89.60	89.60
	One Sided w/plate	<b>87</b>	43.60	43.60	43.60	43.60	43.60	43.60	N/A	N/A	N/A	N/A

STRIKES - AVAILABLE OPTIONS			
ITEM	CORNER SPECS	MODEL NO	LIST PRICE UPCHARGE
Standard 1" - 2-1/4" SC Strike	Square Corner	YR02082	N/C when specified
Standard 1" - 2-1/4" RC Strike	Round Corner	YR02080	N/C when specified
1-1/8" - 2-3/4" SC Universal Deadbolt Strike	Square Corner	YR02086	N/C when specified
1-1/8" - 2-3/4" RC Universal Deadbolt Strike	Round Corner	YR02088	N/C when specified
1-1/8" - 2-3/4" RC Universal Deadbolt Strike	Round Corner	YR02089	N/C when specified
1-1/4" - 3-5/8" RC Maximum Security Strike	Round Corner	YR02081	Add \$1.00
1-1/4" - 3-5/8" SC Maximum Security Strike	Square Corner	YR02083	Add \$1.00
1-3/4" - 2-1/4" RC Full Lip Strike^	Round Corner	YR02084	N/C when specified







\* Specify finish when ordering  
 ^ Not available for 85 deadbolt







AVAILABLE OPTIONS		LIST PRICE UPCHARGE
	UL 90 Minute listing	6.90
	UL 90 Minute listing Combo Sets	13.80



AVAILABLE OPTIONS		LIST PRICE UPCHARGE
<a href="#">Page 27</a>	Grade 2 Latches	NC when specified
<a href="#">Page 46</a>	Additional keying options	
<a href="#">Page 47</a>	Para cylinder options (Not available for 85 deadbolt)	3.40
Extension Kit 2 to 2-1/4" Single Deadbolt Only (Thick Door Pack) #YR07600		14.40 (specify finish)

# HERITAGE COLLECTION GRADE 2 LATCHES

## LIST PRICE

INTERIOR SPRING LATCHES	DESCRIPTION	DIMENSION	CORNER SPECS	MODEL NO	LIST PRICE
	2-3/8" Spring Latch	1 x 2-1/4"	Square Corner	YR01D05*	12.30
	2-3/8" Spring Latch	1 x 2-1/4"	Round Corner	YR01D02*	12.30
	2-3/4" Spring Latch	1 x 2-1/4"	Square Corner	YR01D06*	12.30
	2-3/4" Spring Latch	1 x 2-1/4"	Round Corner	YR01D08*	12.30
	2-3/8" Spring Drive-In Latch	1" Dia.	N/A	YR01D11*	12.30
	2-3/4" Spring Drive-In Latch	1" Dia.	N/A	YR01D13*	12.30
	2-3/8" - 2-3/4" Adj. Spring Latch	1 x 2-1/4"	Square Corner	YR01D17*	12.30
	2-3/8" - 2-3/4" Adj. Spring Latch	1 x 2-1/4"	Round Corner	YR01D14*	12.30
	2-3/8" - 2-3/4" Adj. Spring Dr. In Latch	1" Dia.	N/A	YR01D71*	12.30

EXTERIOR DEADLOCKING LATCHES	DESCRIPTION	DIMENSION	CORNER SPECS	MODEL NO	LIST PRICE
	2-3/8" Deadlocking Latch	1 x 2-1/4"	Square Corner	YR01D25*	12.30
	2-3/8" Deadlocking Latch	1 x 2-1/4"	Round Corner	YR01D22*	12.30
	2-3/4" Deadlocking Latch	1 x 2-1/4"	Square Corner	YR01D26*	12.30
	2-3/4" Deadlocking Latch	1 x 2-1/4"	Round Corner	YR01D28*	12.30
	2-3/8" Deadlocking Dr. In Latch	1" Dia.	N/A	YR01D32*	12.30
	2-3/4" Deadlocking Dr. In Latch	1" Dia.	N/A	YR01D34*	12.30
	2-3/8" - 2-3/4" Adj. Deadlocking Latch	1 x 2-1/4"	Square Corner	YR01D30*	12.30
	2-3/8" - 2-3/4" Adj. Deadlocking Latch	1 x 2-1/4"	Round Corner	YR01D31*	12.30
	2-3/8" - 2-3/4" Adj. Deadlocking Dr. In Latch	1" Dia.	N/A	YR01D33*	12.30

ADJUSTABLE DEADBOLT LATCHES	DESCRIPTION	DIMENSION	CORNER SPECS	MODEL NO	LIST PRICE
	2-3/8" - 2-3/4" Adj. Deadbolt Latch		Square Corner	YR01D44*	12.30
	2-3/8" - 2-3/4" Adj. Deadbolt Latch		Round Corner	YR01D41*	12.30
	2-3/8" - 2-3/4" Adj. Deadbolt Drive-In Latch	1" Dia.	N/A	YR01D47*	12.30

\*Specify finish when ordering

# HERITAGE COLLECTION GRADE 3 TABLE OF CONTENTS



<a href="#">Levers</a> .....	<a href="#">29</a>
<a href="#">Knobs</a> .....	<a href="#">32</a>
<a href="#">Deadbolts</a> .....	<a href="#">35</a>

**HERITAGE COLLECTION GRADE 3  
LEVER LOCKSETS**  
Doors Require Blocking

With concealed holding screws, and a strengthened square spindle, Heritage Collection Grade 3 products reflect an outstanding commitment to quality. Like the Heritage Collection Grade 3 knobs, the levers are exquisitely designed. With free-flowing curves and smooth edges, the Mesa, Niagara, Prairie, Savannah, Vernal, Vidalia, and Woodland levers offer impeccable elegance at an exceptional price.

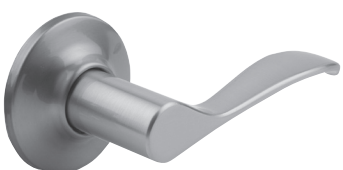
<p><b>Mesa (ML)</b></p> 	<p><b>Niagara (NL)</b></p> 	<p><b>Prairie (PL)</b></p> 
<p><b>Savannah (SL)</b></p> 	<p><b>Vernal (VE)</b></p> 	<p><b>Vidalia (VI)</b></p> 
<p><b>Vidalia (VISQ) (Square Rose)</b></p> 	<p><b>Woodland (WL)</b></p> 	

# HERITAGE COLLECTION GRADE 3 LEVER LOCKSETS



Functions		
Function	No.	Description
	81	DUMMY: For doors where only pull is required. (handing required)
	101*	PASSAGE: Latchbolt is operated by either lever at all times. (non-handed)
	161	ONE SIDED W/PLATE: Latchbolt is operated by lever on one side only. (handing required)
	201	PRIVACY: Latchbolt is operated by either lever except when inside lever is locked by turn button. A coin turn releases turn button and unlocks outside lever. (non-handed)
	221	BATHROOM: Same function as 201 privacy with 625 finish on interior lever. (handing required)
	701	ENTRY (KNOB/LEVER): Guarded latch bolt operated from outside by key; inside by lever. Turn button locks out side knob. Outside knob unlocks by key or by turning inside turn button.
	771	ENTRY (LEVER/LEVER): Guarded latch bolt operated from outside lever by key. Inside by lever. Turn button locks both levers. Levers unlock by key or by turning inside turn button.

Dimensions	A	B	C
Mesa	2-9/16"	2-3/8"	3-1/4"
Niagara	2-9/16"	2-1/2"	4-7/32"
Savannah	2-9/16"	2-1/4"	3-7/8"
Prairie	2-9/16"	2-7/16"	4-19/64"
Vernal	2-9/16"	2-9/16"	4-1/2"
Vidalia	2-9/16"	2-1/2"	4-5/8"
Woodland	2-9/16"	2-5/8"	3-7/8"

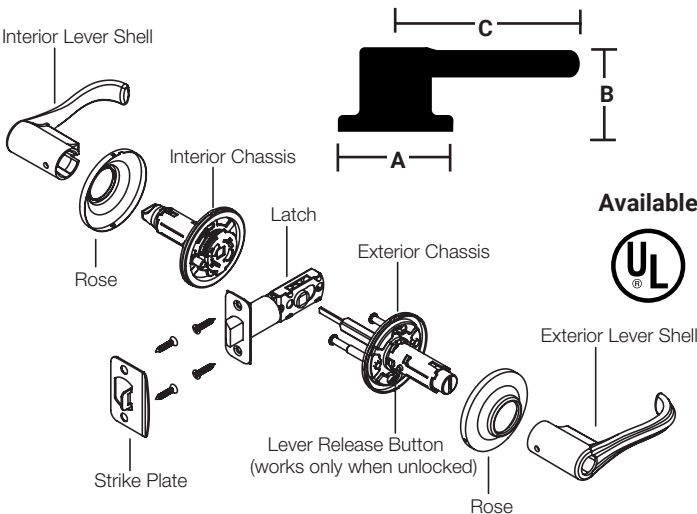

Product Specifications	
<b>Door Specs</b>	2-1/8" Face Bore, 1" Edge Bore, 2-3/8" or 2-3/4" Backset Latch Face 1" x 2-1/4" Round corner (Square corner optional)
<b>Latch</b>	Adjustable 2-3/8" or 2-3/4" RC (round corner)
<b>Door Thickness</b>	1-3/8" to 1-3/4"
<b>Cylinder</b>	5 Pin KW-1 Cylinder Standard (SC-1 Optional)
<b>Keying</b>	KA3 (Keyed Alike)
<b>Faceplate</b>	1" W x 2-1/4" H RC (Round Corner)
<b>Strike</b>	2-1/4" Full Lip RC (Round Corner)
<b>Designed to Meet ANSI/BHMA</b>	A156.2 Series 4000 Grade 3 A156.39 Grade B

Standard Case Quantities - Enter the exact number of individual units required. As an example: If there are 24 units in a case and you require 1 case, enter 24 in the "quantity" space. See below for an example of standard case quantities.

STANDARD CASE QUANTITIES	
	Quantity
Levers	12

### How To Determine Handing Of Doors

- The handing of a door is always determined by facing the exterior of a door.
  - If the hinge is on the left side of the door, the door is left handed (LH).
  - If the hinge is on the right side of the door, the door is right handed (RH).
  - To order a handed product, specify LH or RH.
- Not all products are handed; only specify handing when required.



Storeroom, Classroom, Dummies, and Interior Packs require handing

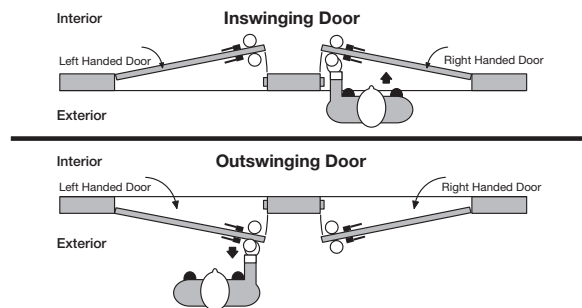

# HERITAGE COLLECTION GRADE 3 LEVER LOCKSETS



## DECORATIVE ROSES

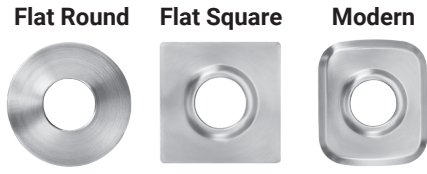

**Flat Round** 2-9/16" Dia  
Center Hole: 1-1/32"

**Flat Square** 2-9/16" W x 2-9/16" H  
Center Hole: 1-1/32"

**Modern** 2-9/16" W x 3" H  
Center Hole: 1-1/32"

PAIR WITH ALL HERITAGE GRADE 3 LEVER STYLES.

Roses Availability	605	10BP	619	BSP	625	626	List Upcharge	
							Full Lockset	Dummy
Flat Round		•	•	•	•	•	11.50	5.80
Flat Square		•	•	•	•	•	18.30	9.20
Modern		•	•	•			18.30	9.20

Note: Decorative roses ship separate as kit.

LIST PRICE													
Levers	DESIGN	FUNCTION	NO	605	626	609	619	GM Gun Metal	BSP Black Suede	625	620	613E	10BP
Featuring Quick Install Design		BHMA											
Mesa (ML)	Dummy		81	N/A	22.50	22.50	22.50	N/A	N/A	N/A	N/A	24.10	N/A
	Passage		101	N/A	53.40	53.40	53.40	N/A	N/A	N/A	N/A	56.80	N/A
	One Sided w/plate		161	N/A	53.40	53.40	53.40	N/A	N/A	N/A	N/A	56.80	N/A
	Privacy		201	N/A	55.60	55.60	55.60	N/A	N/A	N/A	N/A	59.20	N/A
	Entry (Knob/Lever)		701	N/A	71.20	71.20	71.20	N/A	N/A	N/A	N/A	74.60	N/A
Niagara (NL)	Dummy		81	22.50	22.50	22.50	22.50	22.50	22.50	24.10	24.10	24.10	24.10
	Passage		101	53.40	53.40	53.40	53.40	53.40	53.40	56.80	56.80	56.80	56.80
	One Sided w/plate		161	53.40	53.40	53.40	53.40	53.40	53.40	56.80	56.80	56.80	56.80
	Privacy		201	55.60	55.60	55.60	55.60	55.60	55.60	59.20	59.20	59.20	59.20
	Bath*		221	59.20	59.20	59.20	59.20	59.20	59.20	N/A	62.50	62.50	62.50
Prairie (PL)	Entry (Lever/Lever)		771	77.70	77.70	77.70	77.70	77.70	77.70	81.10	81.10	81.10	81.10
	Dummy		81	N/A	22.50	22.50	22.50	N/A	N/A	24.10	N/A	N/A	N/A
	Passage		101	N/A	53.40	53.40	53.40	N/A	N/A	56.80	N/A	N/A	N/A
	One Sided w/plate		161	N/A	53.40	53.40	53.40	N/A	N/A	56.80	N/A	N/A	N/A
	Privacy		201	N/A	55.60	55.60	55.60	N/A	N/A	59.20	N/A	N/A	N/A
Savannah (SL)	Bath*		221	N/A	59.20	59.20	59.20	N/A	N/A	N/A	N/A	N/A	N/A
	Entry (Lever/Lever)		771	N/A	77.70	77.70	77.70	N/A	N/A	81.10	N/A	N/A	N/A
	Dummy		81	22.50	22.50	22.50	22.50	22.50	22.50	24.10	24.10	24.10	24.10
	Passage		101	53.40	53.40	53.40	53.40	53.40	53.40	56.80	56.80	56.80	56.80
	One Sided w/plate		161	53.40	53.40	53.40	53.40	53.40	53.40	56.80	56.80	56.80	56.80
Vernal (VE)	Privacy		201	55.60	55.60	55.60	55.60	55.60	55.60	59.20	59.20	59.20	59.20
	Bath*		221	59.20	59.20	59.20	59.20	59.20	59.20	N/A	62.50	62.50	62.50
	Entry (Lever/Lever)		771	77.70	77.70	77.70	77.70	77.70	77.70	81.10	81.10	81.10	81.10
	Dummy		81	N/A	22.50	N/A	22.50	N/A	22.50	N/A	N/A	24.10	24.10
	Passage		101	N/A	53.40	N/A	53.40	N/A	53.40	N/A	N/A	56.80	56.80
Vidalia (VI)	One Sided w/plate		161	N/A	53.40	N/A	53.40	N/A	53.40	56.80	N/A	N/A	56.80
	Privacy		201	N/A	55.60	N/A	55.60	N/A	55.60	59.20	N/A	N/A	59.20
	Bath*		221	N/A	59.20	N/A	59.20	N/A	59.20	62.50	N/A	N/A	62.50
	Entry (Lever/Lever)		771	N/A	77.70	N/A	77.70	N/A	77.70	81.10	N/A	N/A	81.10
	Dummy		81	N/A	N/A	N/A	31.70	N/A	31.70	N/A	N/A	N/A	33.40
Vidalia SQR Rose (VISQ)	Passage		101	N/A	N/A	N/A	71.70	N/A	71.70	N/A	N/A	N/A	75.10
	One Sided w/plate		161	N/A	N/A	N/A	71.70	N/A	71.70	N/A	N/A	N/A	75.10
	Privacy		201	N/A	N/A	N/A	74.00	N/A	74.00	N/A	N/A	N/A	77.50
	Bath*		221	N/A	N/A	N/A	77.50	N/A	77.50	N/A	N/A	N/A	80.90
	Entry (Lever/Lever)		771	N/A	N/A	N/A	105.70	N/A	105.70	N/A	N/A	N/A	109.20
Woodland (WL)	Dummy		81	22.50	22.50	22.50	22.50	22.50	22.50	24.10	24.10	24.10	24.10
	Passage		101	53.40	53.40	53.40	53.40	53.40	53.40	56.80	56.80	56.80	56.80
	One Sided w/plate		161	53.40	53.40	53.40	53.40	53.40	53.40	56.80	56.80	56.80	56.80
	Privacy		201	55.60	55.60	55.60	55.60	55.60	55.60	59.20	59.20	59.20	59.20
	Bath*		221	59.20	59.20	59.20	59.20	59.20	59.20	62.50	62.50	62.50	62.50
Entry (Lever/Lever)		771	77.70	77.70	77.70	77.70	77.70	77.70	81.10	81.10	81.10	81.10	

\*Bath Function has 625 Polished Chrome Interior

AVAILABLE OPTIONS		LIST PRICE UPCHARGE
	UL 90 Minute listing	6.90
	UL 90 Minute listing Combo Sets	13.80

Note: All Heritage Collection Grade 3 entry 701 function leversets will be shipped with the Cirrus knob exterior unless otherwise specified. Heritage Collection Grade 3 levers are designed to be reversible to eliminate handing errors (except for the single dummy function #81, and entry function #701). For the single dummy (function #81) and entry functions (function #701), please specify handing either right hand (RH) or left hand (LH) when ordering these functions, or when ordering split finishes.

AVAILABLE OPTIONS		LIST PRICE UPCHARGE
Page 38	Grade 3 Latches	NC when specified
Page 45	T-Strikes	1.70
Page 45	ANSI 4 7/8" Strike	7.60
Page 45	Other Lockset Strikes	NC when specified
Page 46	Additional keying options	
Page 47	Para cylinder options	3.40
	GA Keyway (allow for extended lead time)	Add 20.00

**HERITAGE COLLECTION GRADE 3**  
**KNOB LOCKSETS**  
 Doors Require Blocking



The ASSA ABLOY ACCENTRA® standard duty knobs from the Heritage Collection Grade 3 series offer outstanding strength, durability and simple, elegant designs highlighted by natural curves for comfort and ease of turning. The Cirrus, Horizon, Oasis, Terra, and Valley knobs are built to the highest quality standards. These products are built on a steel Grade 3 chassis and feature concealed holding screws. In addition, all Heritage Collection Grade 3 products feature “Quick-Install,” a unique chassis design, which drastically reduces installation time. The Heritage Collection Grade 3 series offers all of these superb features at an incredible value.

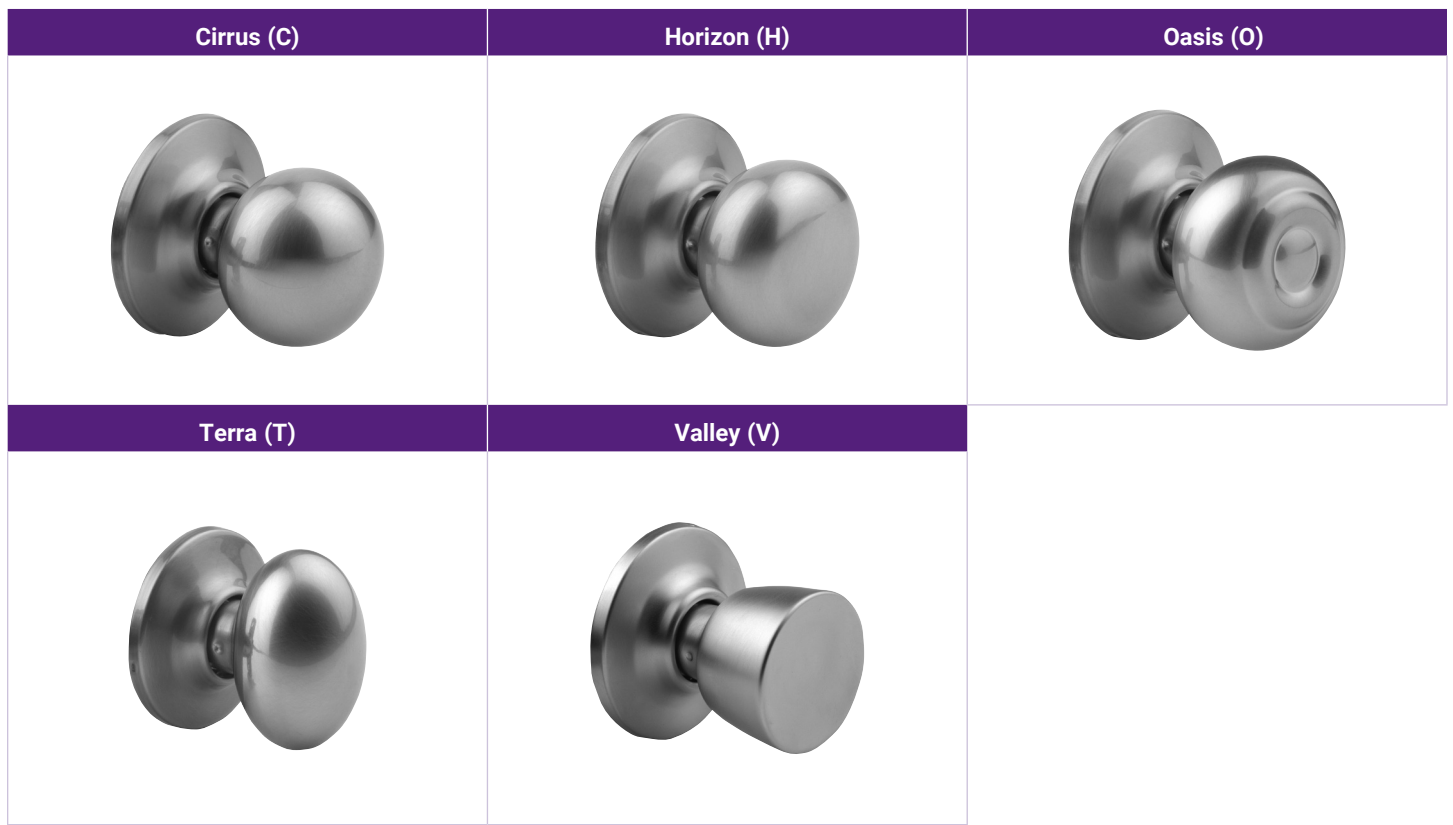

# HERITAGE COLLECTION GRADE 3 KNOB LOCKSETS



FUNCTIONS		
FUNCTION	NO.	DESCRIPTION
	80	DUMMY: For doors where only pull is required.
	100	PASSAGE: Latchbolt is operated by either knob at all times.
	160	ONE SIDED W/PLATE: Latchbolt is operated by knob on one side only.
	200	PRIVACY: Latchbolt is operated by either knob except when inside knob is locked by turn button. A special emergency key releases turn button and unlocks outside knob.
	226	BATHROOM: Same function as 200 privacy with 625 finish on interior knob.
	700	ENTRY: Guarded Latch bolt operated from outside by key. Inside by knob. Turn button Locks both knobs. Knobs unlock by Key outside or by rotating inside turn button.

PRODUCT SPECIFICATIONS	
<b>Door Specs</b>	2-1/8" Face Bore, 1" Edge Bore, 2-3/8" or 2-3/4" Backset Latch Face 1" x 2-1/4" Round corner (Square corner optional)
<b>Latch</b>	Adjustable 2-3/8" or 2-3/4" RC (round corner)
<b>Door Thickness</b>	1-3/8" to 1-3/4"
<b>Cylinder</b>	5 Pin KW-1 Cylinder Standard (SC-1 Optional)
<b>Keying</b>	KA3 (Keyed Alike)
<b>Faceplate</b>	1" W x 2-1/4" H RC (Round Corner)
<b>Strike</b>	2-1/4" Full Lip RC (Round Corner)
<b>Designed to Meet ANSI/BHMA</b>	A156.2 Series 4000 Grade 3 A156.39 Grade B

DIMENSIONS	A	B	C
<b>Cirrus</b>	2-9/16"	2-1/2"	2"
<b>Horizon</b>	2-9/16"	2-1/4"	2"
<b>Oasis</b>	2-9/16"	2-1/4"	2"
<b>Terra</b>	2-9/16"	2-3/8"	2-1/2"
<b>Valley</b>	2-9/16"	2-5/16"	1-15/16"

Standard Case Quantities - Enter the exact number of individual units required. As an example: If there are 24 units in a case and you require 1 case, enter 24 in the "quantity" space. See below for an example of standard case quantities.

STANDARD CASE QUANTITIES	
	Quantity
<b>Knobs</b>	24
<b>Combo Sets</b>	12

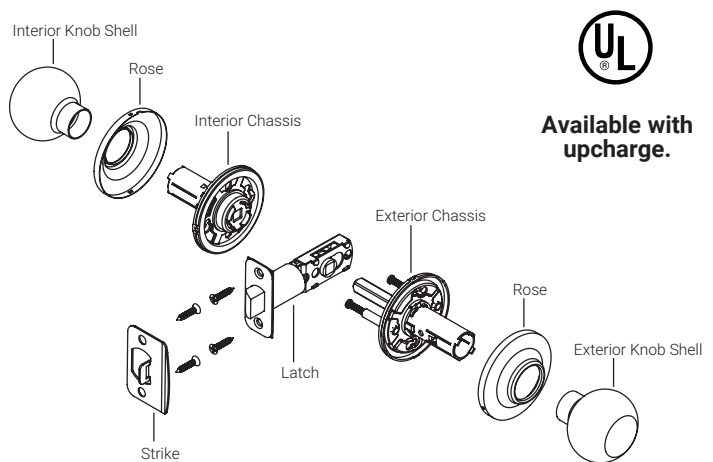
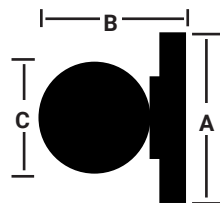

# HERITAGE COLLECTION GRADE 3 KNOB LOCKSETS



LIST PRICE												
DESIGN	FUNCTION BHMA	NO	605	626	609	619	GM Gun Metal	BSP Black Suede	625	620	613E	10BP
<b>Cirrus (C)</b>	Dummy	80	14.40	14.40	N/A	14.40	14.40	N/A	15.50	15.50	15.50	15.50
	Passage	100	31.90	31.90	N/A	31.90	31.90	N/A	34.20	34.20	34.20	34.20
	One Sided w/plate	160	31.90	31.90	N/A	31.90	31.90	N/A	34.20	34.20	34.20	34.20
	Privacy	200	34.40	34.40	N/A	34.40	34.40	N/A	36.90	36.90	36.90	36.90
	Bath*	226	37.90	37.90	N/A	37.90	37.90	N/A	N/A	40.20	40.20	40.20
	Entry	700	43.70	43.70	N/A	43.70	43.70	N/A	46.10	46.10	46.10	46.10
<b>Horizon (H)</b>	Dummy	80	14.40	14.40	14.40	14.40	14.40	14.40	15.50	15.50	15.50	15.50
	Passage	100	31.90	31.90	31.90	31.90	31.90	31.90	34.20	34.20	34.20	34.20
	One Sided w/plate	160	31.90	31.90	31.90	31.90	31.90	31.90	34.20	34.20	34.20	34.20
	Privacy	200	34.40	34.40	34.40	34.40	34.40	34.40	36.90	36.90	36.90	36.90
	Bath*	226	37.90	37.90	37.90	37.90	37.90	37.90	N/A	40.20	40.20	40.20
	Entry	700	43.70	43.70	43.70	43.70	43.70	43.70	46.10	46.10	46.10	46.10
<b>Oasis (O)</b>	Dummy	80	N/A	N/A	N/A	15.50	N/A	N/A	N/A	N/A	N/A	16.70
	Passage	100	N/A	N/A	N/A	33.80	N/A	N/A	N/A	N/A	N/A	36.20
	One Sided w/plate	160	N/A	N/A	N/A	33.80	N/A	N/A	N/A	N/A	N/A	36.20
	Privacy	200	N/A	N/A	N/A	37.60	N/A	N/A	N/A	N/A	N/A	39.90
	Bath*	226	N/A	N/A	N/A	N/A	N/A	N/A	N/A	N/A	N/A	N/A
	Entry	700	N/A	N/A	N/A	47.70	N/A	N/A	N/A	N/A	N/A	49.80
<b>Terra (T)</b>	Dummy	80	N/A	N/A	N/A	18.80	18.80	N/A	N/A	N/A	N/A	19.90
	Passage	100	N/A	N/A	N/A	43.60	43.60	N/A	N/A	N/A	N/A	46.00
	One Sided w/plate	160	N/A	N/A	N/A	43.60	43.60	N/A	N/A	N/A	N/A	46.00
	Privacy	200	N/A	N/A	N/A	46.00	46.00	N/A	N/A	N/A	N/A	48.30
	Bath*	226	N/A	N/A	N/A	N/A	N/A	N/A	N/A	N/A	N/A	N/A
	Entry	700	N/A	N/A	N/A	65.50	65.50	N/A	N/A	N/A	N/A	67.80
<b>Valley (V)</b>	Dummy	80	14.40	14.40	N/A	N/A	N/A	N/A	N/A	N/A	N/A	N/A
	Passage	100	31.90	31.90	N/A	N/A	N/A	N/A	N/A	N/A	N/A	N/A
	One Sided w/plate	160	31.90	31.90	N/A	N/A	N/A	N/A	N/A	N/A	N/A	N/A
	Privacy	200	34.40	34.40	N/A	N/A	N/A	N/A	N/A	N/A	N/A	N/A
	Bath*	226	37.90	37.90	N/A	N/A	N/A	N/A	N/A	N/A	N/A	N/A
	Entry	700	43.70	43.70	N/A	N/A	N/A	N/A	N/A	N/A	N/A	N/A

\*Bath Function has 625 Polished Chrome Interior

KNOB COMBO SET – LIST PRICE												
Combo Sets Include 1 Entry Knob with 1 Single Cylinder Deadbolt												
DESIGN	FUNCTION BHMA	NO	605	626	609	619	GM Gun Metal	BSP Black Suede	625	620	613E	10BP
<b>Cirrus (C)</b>	Single Cylinder	827	87.60	87.60	N/A	87.60	87.60	N/A	99.50	99.50	99.50	99.50
<b>Horizon (H)</b>	Single Cylinder	827	87.60	87.60	87.60	87.60	87.60	76.20	99.50	99.50	99.50	99.50
<b>Oasis (O)</b>	Single Cylinder	827	N/A	N/A	N/A	91.40	N/A	N/A	N/A	N/A	N/A	109.30
<b>Terra (T)</b>	Single Cylinder	827	N/A	N/A	N/A	109.30	109.30	N/A	N/A	N/A	N/A	117.40
<b>Valley (V)</b>	Single Cylinder	827	87.60	87.60	N/A	N/A	N/A	N/A	N/A	N/A	N/A	N/A







AVAILABLE OPTIONS			LIST PRICE UPCHARGE
	UL 90 Minute listing		6.80
	UL 90 Minute listing	Combo Sets	13.80

AVAILABLE OPTIONS		LIST PRICE UPCHARGE
<b>Page 38</b>	Heritage Collection Grade 3 Series Latches	NC when specified
<b>Page 45</b>	T-Strikes	1.70
<b>Page 45</b>	ANSI 4-7/8" Strike	7.60
<b>Page 45</b>	Other Lockset Strikes	NC when specified
<b>Page 46</b>	Additional keying options	
<b>Page 47</b>	Para cylinder options	3.40
	GA Keyway (allow for extended lead time)	Add 20.00

US and Canada Prices Effective February 2, 2026 / [Canada 2026 Tariff Price Adjustments](#)

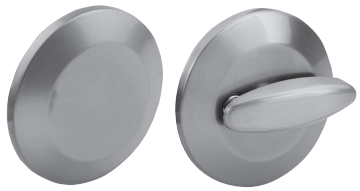
# HERITAGE COLLECTION GRADE 3 DEADBOLTS

The ASSA ABLOY ACCENTRA® Grade 3 deadbolts offer a variety of functions and finishes, and are compatible with all Heritage Collection Grade 3 leversets and knobsets. The 800 series deadbolts offer excellent strength and reliability, certified to an ANSI Grade 3.

810 Dummy	820 Single Cylinder	840 Double Cylinder
		
860 One Sided with plate	880 One Way	
		
820R Single Cylinder	820S Single Cylinder	820M Single Cylinder
		

# HERITAGE COLLECTION GRADE 3 DEADBOLTS



Functions		
Function	No.	Description
	810	DUMMY: No cylinder, no latch
	820	SINGLE CYLINDER: Latch operated from the outside by key, inside by T-turn.
	840	DOUBLE CYLINDER: Latch operated from either side by the key.
	860	ONE SIDED DEADBOLT WITH PLATE: No cylinder. Latch operated by the T-turn on the inside. For doors bored completely through.
	880	ONE WAY: No cylinder. Latch operated by the T-turn on the inside. For doors not bored completely through.

Product Specifications	
<b>Door Specs</b>	2-1/8" Face Bore, 1" Edge Bore, Latch Face 1" x 2-1/4" Round corner (Square corner optional)
<b>Latch</b>	Adjustable 2-3/8" or 2-3/4" RC (round corner)
<b>Door Thickness</b>	1-3/8" to 1-3/4"
<b>Cylinder</b>	5 Pin KW-1 Cylinder Standard (SC-1 Optional)
<b>Keying</b>	KA3 (Keyed Alike)
<b>Faceplate</b>	1" W x 2-1/4" H RC (Round Corner)
<b>Strike</b>	1" x 2-1/4" RC RC (Round Corner)
<b>Certified ANSI/BHMA</b>	A156.36 Grade 3 A156.40 Grade C

Meets ADA Guidelines

Standard Case Quantities - Enter the exact number of individual units required. As an example: If there are 24 units in a case and you require 1 case, enter 24 in the "quantity" space. See below for an example of standard case quantities.

Dimensions	A	B	C
<b>800 Interior</b>	2-1/2"	15/16"	2"
<b>800 Exterior</b>	2-1/2"	1"	1-7/8"
<b>820R/820S Interior</b>	2-1/2"	7/8"	1-5/16"
<b>820R/820S Exterior</b>	2-1/2"	7/8"	2-1/2"
<b>820M Interior</b>	3"	1"	2"
<b>820M Exterior</b>	3"	7/8"	2-3/8"

STANDARD CASE QUANTITIES	
	Quantity
<b>Deadbolts</b>	12

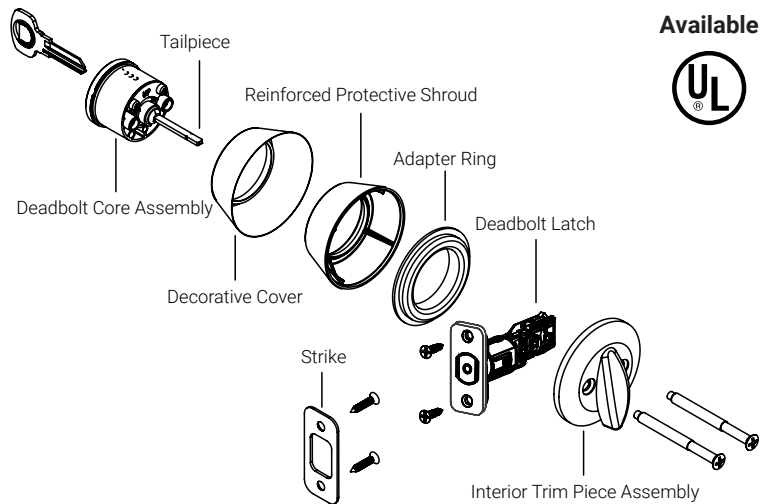
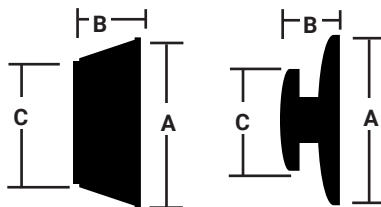

# HERITAGE COLLECTION GRADE 3 DEADBOLTS





LIST PRICE												
800 SERIES DEADBOLTS	FUNCTION	NO BHMA	605	626	609	619	GM Gun Metal	BSP Black Suede	625	620	613E	US10BP
	Dummy	810	32.20	32.20	32.20	32.20	N/A	N/A	37.90	37.90	N/A	37.90
	Single Cylinder	820	43.70	43.70	43.70	43.70	43.70	43.70	49.50	49.50	49.50	49.50
	Double Cylinder	840	55.10	55.10	55.10	55.10	55.10	55.10	60.90	60.90	60.90	60.90
	One Sided W/Plate	860	36.40	36.40	36.40	36.40	36.40	36.40	42.10	42.10	42.10	42.10
	Oneway*	880	26.50	26.50	26.50	26.50	26.50	26.50	33.30	33.30	33.30	33.30
Only available 20 minute UL	Flat Round Single Cyl**	820R	63.90	63.90	63.90	63.90	63.90	63.90	68.50	68.50	68.50	68.50
	Flat Square Single Cyl**	820S	63.90	63.90	63.90	63.90	63.90	63.90	68.50	68.50	68.50	68.50
	Modern Single Cyl**	820M	N/A	N/A	N/A	63.90	N/A	63.90	N/A	N/A	N/A	63.80

\*880 deadbolt available fixed latch only. 2-3/8 RC is Std.  
 \*\*Only available 20 minute UL

STRIKES - AVAILABLE OPTIONS			
ITEM	CORNER SPECS	MODEL NO	LIST PRICE UPCHARGE
Standard 1" - 21/4" /SC Strike	Square Corner	YR02082	N/C when specified
Standard 1" - 21/4" /RC Strike	Round Corner	YR02080	N/C when specified
11/8" - 23/4" /SC Strike	Square Corner	YR02086	N/C when specified
11/8" - 23/4" /RC Strike	Round Corner	YR02088	N/C when specified
11/4" - 35/8" /RC Maximum Security Strike	Square Corner	YR02081	Add \$1.10
11/4" - 35/8" /SC Maximum Security Strike	Round Corner	YR02083	Add \$1.10
13/4" - 21/4" /RC Full Lip Strike	Round Corner	YR02084	N/C when specified
Screw Pack (4 each 3" Screws)		08818*	1.70

\* Specify finish when ordering



AVAILABLE OPTIONS	LIST PRICE UPCHARGE
 UL 90 Minute listing	6.80
 UL 90 Minute listing Combo Sets	13.70



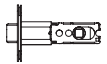
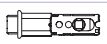

# HERITAGE COLLECTION GRADE 3 LATCHES

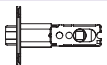

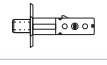

## LIST PRICE

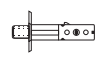
INTERIOR SPRING LATCHES	DESCRIPTION	DIMENSION	CORNER SPECS	MODEL NO	LIST PRICE
	2 3/8"-2 3/4" Adj. Spring Latch	1 x 2-1/4"	Square Corner	YR01464*	6.90
	2 3/8"-2 3/4" Adj. Spring Latch	1 x 2-1/4"	Round Corner	YR01461*	6.90
	2 3/8"-2 3/4" Drive-In Spring Latch	1" Dia.	N/A	YR01D71*	11.70

EXTERIOR DEADLOCKING LATCHES	DESCRIPTION	DIMENSION	CORNER SPECS	MODEL NO	LIST PRICE
	2 3/8"-2 3/4" Adj. Deadlocking Latch	1 x 2-1/4"	Square Corner	YR01474*	8.00
	2 3/8"-2 3/4" Adj. Deadlocking Latch	1 x 2-1/4"	Round Corner	YR01471*	8.00
	2 3/8"-2 3/4" Adj. Deadlocking Drive.-In Latch	1" Dia.	N/A	YR01D33*	11.70

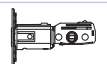
DEADBOLT LATCHES 880 Deadbolt Only	DESCRIPTION	DIMENSION	CORNER SPECS	MODEL NO	LIST PRICE
	2 3/8" Deadbolt Latch	1 x 2-1/4"	Square Corner	YR01445*	11.70
	2 3/8" Deadbolt Latch	1 x 2-1/4"	Round Corner	YR01442*	11.70
	2 3/8" Deadbolt Drive-In Latch	1" Dia.	N/A	YR01448*	11.70
	2 3/4" Deadbolt Latch	1 x 2-1/4"	Square Corner	YR01446*	11.70
	2 3/4" Deadbolt Latch	1 x 2-1/4"	Round Corner	YR01443*	11.70
	2 3/4" Deadbolt Drive-In Latch	1" Dia.	N/A	YR01449*	11.70

ADJUSTABLE DEADBOLT LATCHES	DESCRIPTION	DIMENSION	CORNER SPECS	MODEL NO	LIST PRICE
<b>820, 840, 860 Deadbolts &amp; Handlesets</b>					
	2 3/8"-2 3/4" Adj. Deadbolt Latch		Square Corner	YR01D44*	11.70
	2 3/8"-2 3/4" Adj. Deadbolt Latch		Round Corner	YR01D41*	11.70
	2 3/8"-2 3/4" Adj. Deadbolt Drive-In Latch	1" Dia.	N/A	YR01D47*	11.70

\*Specify finish when ordering

## DECORATIVE HANDLESETS

Our decorative handlesets combine elegance with ease of installation. These designs offer balanced torque springs on a split-hub for ease of opening, solid thumb pieces, and finishes utilizing the world’s most advanced clear coat technology. Designed to fit most American-made doors, each handleset comes with easy-to-read installation instructions.

Homestead	Jamestown	McKinley
		
Pedestal	Rainier	Ridgefield
		
Teton		
		

# DECORATIVE HANDLESETS



Functions		
Function	No.	Description
	681 682 986 987 988 989	DUMMY: For on-working side of double doors. Non-functioning deadbolt, knob or lever.
	621 622 926 927 928 929	SINGLE CYLINDER: Thumbpiece retracts latch from exterior side. Knob or lever retracts latch from interior side. Deadbolt latch retracts with key from exterior side, T-turn retracts deadbolt latch from interior side.
	641 642 946 947	DOUBLE CYLINDER: Thumbpiece retracts latch from exterior side. Knob or lever retracts latch from interior side. Deadbolt latch retracts with key from exterior side and interior side.

Product Specifications	
<b>Door Specs</b>	2-1/8" Face Bore, 1" Edge Bore, 5-1/2" O.C. Latch Face 1" x 2-1/4" RC (Round Corner)
<b>Latch</b>	2-3/8" RC (Round Corner) Deadbolt: 2-3/8"–2-3/4" ADJ. RC (Round Corner)
<b>Door Thickness</b>	1-3/4" 2" to 2-1/4" Requires Ext. Kit 07600
<b>Cylinder Keying</b>	KW-1 Standard KD (Keyed Different)
<b>Faceplate</b>	1" W x 2-1/4" H RC (Round Corner)
<b>Strike</b>	Spring latch 2-1/4" Full Lip RC (Round Corner) Deadbolt: 1"x 2-1/4" RC (Round Corner) Deadbolt: 1"x 2-1/4" RC (Round Corner)
<b>Interior Trim</b>	Specify Interior Trim Design

Standard Case Quantities - Enter the exact number of individual units required. As an example: If there are 24 units in a case and you require 1 case, enter 24 in the "quantity" space. See below for an example of standard case quantities.

Dimensions	A	B	C	D
<b>Homestead</b>	2-3/8"	5-1/2"	9-11/16"	18"
<b>Jamestown</b>	2-3/8"	5-1/2"	9-11/16"	18"
<b>McKinley</b>	2-3/8"	5-1/2"	9-11/16"	18"
<b>Pedestal</b>	2-11/16"	5-1/2"	9-11/16"	18-1/2"
<b>Rainier</b>	2-3/8"	5-1/2"	9-11/16"	18"
<b>Ridgefield</b>	2-3/8"	5-1/2"	9-11/16"	18"
<b>Teton</b>	2-3/8"	5-1/2"	9-11/16"	18"

STANDARD CASE QUANTITIES	
	Quantity
Handlesets	6
Handlesets - Interior Pack	6

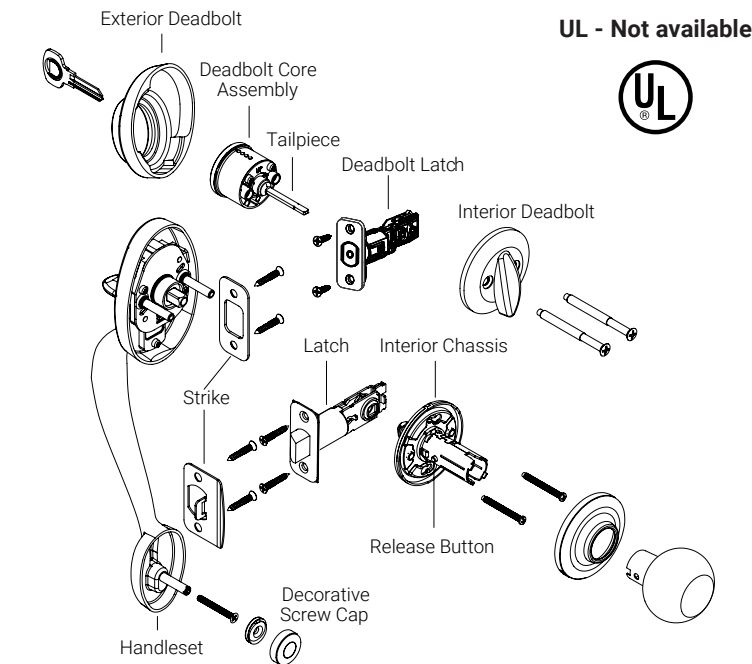
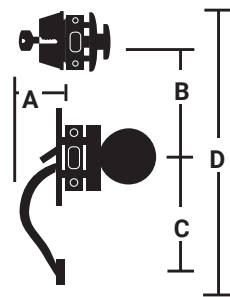

# DECORATIVE HANDLESETS



## LIST PRICE (PRICE INCLUDES INTERIOR TRIM)

### Handlesets - Featuring Quick-Install Design

DESIGN	FUNCTION BHMA	NO	605	625	626	609	619	620	GM Gun Metal	BSP Black Suede	613E	10BP
Homestead	Dummy	986	227.50	227.50	227.50	227.50	227.50	227.50	227.50	227.50	250.50	250.50
	Single Cylinder	926	270.10	270.10	270.10	270.10	270.10	270.10	270.10	270.10	293.00	293.00
	Double Cylinder	946	293.00	293.00	293.00	293.00	293.00	293.00	293.00	293.00	315.90	315.90
Jamestown	Dummy	987	227.50	227.50	227.50	227.50	227.50	227.50	227.50	227.50	250.50	250.50
	Single Cylinder	927	270.10	270.10	270.10	270.10	270.10	270.10	270.10	270.10	293.00	293.00
	Double Cylinder	947	293.00	293.00	293.00	293.00	293.00	293.00	293.00	293.00	315.90	315.90
McKinley	Dummy	682	189.60	189.60	189.60	189.60	189.60	189.60	189.60	189.60	212.50	212.50
	Single Cylinder	622	224.10	224.10	224.10	224.10	224.10	224.10	224.10	224.10	247.00	247.00
	Double Cylinder	642	247.00	247.00	247.00	247.00	247.00	247.00	247.00	247.00	270.10	270.10
Pedestal	Dummy	988	227.50	N/A	N/A	N/A	N/A	N/A	N/A	227.50	N/A	250.50
	Single Cylinder	928	270.10	N/A	N/A	N/A	N/A	N/A	N/A	270.10	N/A	293.00
Teton	Dummy	681	N/A	N/A	N/A	N/A	189.60	189.60	189.60	189.60	N/A	212.50
	Single Cylinder	621	N/A	N/A	N/A	N/A	224.10	224.10	224.10	224.10	N/A	247.00
	Double Cylinder	641	N/A	N/A	N/A	N/A	247.00	247.00	247.00	247.00	N/A	270.10
Rainier	Dummy	683	N/A	189.60	189.60	N/A	189.60	189.60	189.60	189.60	N/A	212.50
	Single Cylinder	623	N/A	224.10	224.10	N/A	224.10	224.10	224.10	224.10	N/A	247.00
	Double Cylinder	643	N/A	247.00	247.00	N/A	247.00	247.00	247.00	247.00	N/A	270.10
Ridgefield	Dummy	989	N/A	N/A	N/A	N/A	227.50	N/A	N/A	227.50	N/A	250.50
	Single Cylinder	929	N/A	N/A	N/A	N/A	270.10	N/A	N/A	270.10	N/A	293.00

NOTE: Handleset Interior Trim - Selection Chart Below.  
Split finish not available.

INTERIOR TRIM ASSEMBLIES	ITEM	MODEL NO	LIST PRICE*
Heritage Collection Grade 2	Dummy	719	22.50
	Single Cylinder Deadbolt	720	28.20
	Double Cylinder Deadbolt	740	33.80
Heritage Collection Grade 3	Dummy	680	22.50
	Single Cylinder Deadbolt	620	28.20
	Double Cylinder Deadbolt	640	33.80
	Vidalia/Valdosta SQR Rose		37.20

\*All finishes

AVAILABLE OPTIONS – BOX PACK ONLY	LIST PRICE UPCHARGE
Page 44 Split-Hub Latches	NC when specified
Page 38 800 Series Deadbolt Latches	NC when specified
Page 45 T-Strikes	1.70
Page 45 ANSI 4-7/8" Strike	7.60
Page 45 Deadbolt Security Strikes	0.90
Page 45 Other Lockset Strikes	NC when specified
Page 46 Additional keying options	NC when specified
Extension Kit 2 to 2-1/4" Heritage Collection Grade 2 and Grade 3 Handleset (Thick Door Pack) #YR07600	14.10 (specify finish)

Note: When ordering handlesets less interior pack, (LIP) deduct the interior trim assembly list price to determine handleset price.  
Specify handing when ordering all lever interior trim assemblies.

US and Canada Prices Effective February 2, 2026 / [Canada 2026 Tariff Price Adjustments](#)

# DECORATIVE HANDLESETS



Heritage Collection Grade 2 Trim										
Design	605	609	10BP	613E	619	620	625	626	GM Gun Metal	BSP Black Suede
Bridgeport	A	N/A	N/A	N/A	A	N/A	A	A	N/A	N/A
Cambridge	A	A	A	A	A	A	A	A	A	A
Dartmouth	A	N/A	A	A	A	N/A	N/A	N/A	A	A
Oxford	A	A	A	N/A	A	N/A	N/A	N/A	N/A	N/A
Academy	N/A	A	N/A	N/A	A	N/A	N/A	A	N/A	N/A
Augusta	A	A	A	A	A	N/A	N/A	A	N/A	N/A
Charleston	N/A	N/A	N/A	A	A	N/A	N/A	A	N/A	A
Delaware	N/A	N/A	A	A	A	N/A	A	A	N/A	A
Kincaid	A	N/A	N/A	N/A	A	N/A	N/A	A	N/A	A
Kincade Black Insert	A	N/A	A	N/A	A	N/A	N/A	N/A	N/A	N/A
Marina	N/A	N/A	A	A	A	N/A	A	A	A	N/A
McClure	A	N/A	A	A	A	A	N/A	A	N/A	N/A
Monroe	A	N/A	N/A	A	A	N/A	N/A	A	N/A	A
Milan	A	N/A	N/A	A	A	N/A	A	A	N/A	N/A
Norwood	A	A	A	A	A	A	A	A	A	A
Pacific Beach	A	A	N/A	N/A	A	N/A	A	A	N/A	N/A
Valdosta	N/A	N/A	A	A	A	N/A	A	A	N/A	A
Virgo	A	N/A	A	A	A	A	A	A	N/A	A

Heritage Collection Grade 3 Trim										
Design	605	609	10BP	613E	619	620	625	626	GM Gun Metal	BSP Black Suede
Cirrus	A	N/A	A	A	A	A	A	A	A	N/A
Horizon	A	A	A	A	A	A	A	A	A	A
Oasis	N/A	N/A	A	N/A	A	N/A	N/A	N/A	N/A	N/A
Terra	N/A	N/A	A	N/A	A	N/A	N/A	N/A	A	N/A
Valley	A	N/A	N/A	N/A	N/A	N/A	N/A	A	N/A	N/A
Mesa	N/A	A	N/A	A	A	N/A	N/A	A	N/A	N/A
Niagara	A	A	A	A	A	A	A	A	A	A
Prairie	N/A	A	N/A	N/A	A	N/A	A	A	N/A	N/A
Savannah	A	A	A	A	A	A	A	A	A	A
Vidalia	N/A	N/A	A	N/A	A	N/A	A	A	N/A	A
Woodland	A	A	A	A	A	A	A	A	A	A

Specify handing when ordering lever interior trim. With split finish orders, strikes match interior finishes.

A = Available as factory direct interior pack selection in Handlesets

N/A = Not available as interior pack selection in Heritage Collection Grade 3

LIST PRICE						
HANDLESET LATCHES - INTERIOR SPLIT HUB SPRING LATCHES	DESCRIPTION	DIMENSION	CORNER SPECS	MODEL NO	LIST PRICE	
	2 3/8" Spring Latch	1 x 2 1/4"	Square Corner	YR01804*	14.60	
	2 3/8" Spring Latch	1 x 2 1/4"	Round Corner	YR01802*	14.60	
	2 3/8" Spring Drive-In Latch	1" Dia.	N/A	YR01803*	14.60	
	2 3/4" Spring Latch	1 x 2 1/4"	Square Corner	YR01808*	14.60	
	2 3/4" Spring Latch	1 x 2 1/4"	Round Corner	YR01806*	14.60	
	2 3/4" Spring Drive-In Latch	1" Dia.	N/A	YR01807*	14.60	

\*Specify finish when ordering

US and Canada Prices Effective February 2, 2026 / [Canada 2026 Tariff Price Adjustments](#)

**STRIKES**

LOCKSET STRIKES				
ITEM	DIMENSIONS	CORNER SPECS	MODEL NO	LIST PRICE
Standard Full Lip Strike/SC	1-3/4" x 2-1/4"	Square Corner	YR02001*	2.30
Standard Full Lip Strike/RC	1-3/4" x 2-1/4"	Round Corner	YR02000*	2.30
T-Strike	1-1/8" x 2-3/4"	Square Corner	YR02020*	1.70
ANSI 4-7/8"	1-1/4" x 4-7/8"	Square Corner	YR02030*	7.60

\* Specify finish when ordering  
Note: Not all finishes available

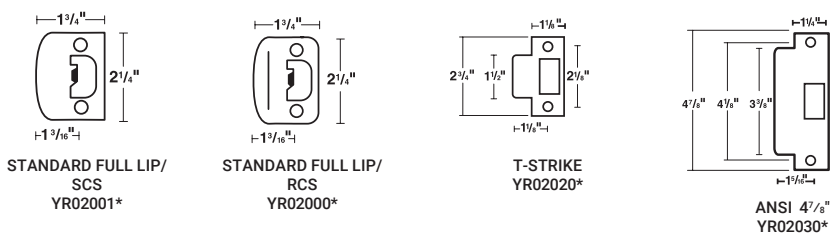

DEADBOLT STRIKES			
ITEM	CORNER SPEC	MODEL NO	LIST PRICE
Standard Deadbolt Strike/SC	Square Corner	YR02082*	2.30
Standard Deadbolt Strike/RC	Round Corner	YR02080*	2.30
Security Strike 3-5/8"	Round Corner	YR02081*	3.00
Security Strike 3-5/8"	Square Corner	YR02083*	3.00
Full Lip Deadbolt Strike	Square Corner	YR02085*	2.30
Full Lip Deadbolt Strike	Round Corner	YR02084*	2.30
Universal Deadbolt Strike	Square Corner	YR02086*	2.30
Universal Deadbolt Strike	Radius Corner	YR02088*	2.30
White Plastic Dust Box 1" x 2-3/4" Deadbolt (For Universal Strike)		YR026002	0.50
Universal Deadbolt Strike with Security Plate	Radius Corner	YR02089*	3.00

\*Specify finish when ordering  
Note: Not all finishes available

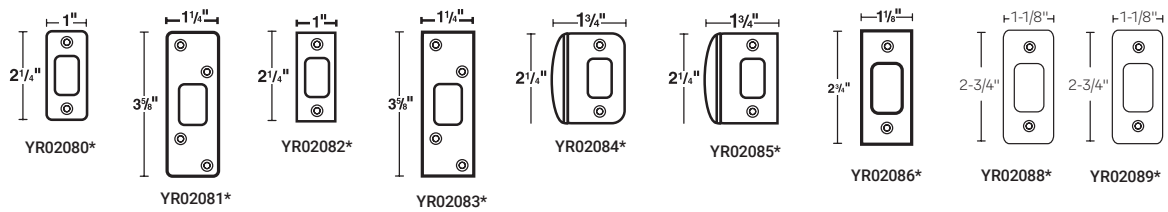

Finish Match For Latch, Strike, Cylinder & Screws* Heritage Collection Grade 2 And Grade 3									
Lock Finish	605	609	US10BP	613E	619	620	625	626	GM/BSP
Latch Face Plate Color	605	609	Black	10BE	Nickel	Black	Nickel	Nickel	Black
Latch Head Color	Nickel	Nickel	Nickel	Nickel	Nickel	Nickel	Nickel	Nickel	Nickel
Standard Strike Plate Color	605	609	Black	10BE	Nickel	Black	Nickel	Nickel	Black
Cylinder Color	Brass	Brass	Brass	Brass	Nickel	Nickel	Nickel	Nickel	Nickel
Screw Color	Brass	Brass	Black	Black	Nickel	Black	Nickel	Nickel	Black
* For Standard Strike & Latch Options Only <b>Note:</b> All Deadbolt Latch Bolts are Nickel									
Latch Filler Plate	Black	035109							

# KEYS AND KEYING OPTIONS



ASSA ABLOY ACCENTRA® KEY BLANKS AND SPECIAL KEYING CHARGES				
	KEY BLANK DESCRIPTION	QUANTITY	MODEL NO	LIST PRICE
	Heritage Collection Grade 2 Key Blank	50 per box	YR068003	1.60
	Heritage Collection Grade 2 6 PIN KW DO NOT COPY Key Blank	50 per box	YR068013	2.30
	Heritage Collection Grade 2 Key - cut	50 per box	YR068550	2.30
	Heritage Collection Grade 2 6 Pin PARA Key Blank	50 per box	YR068Y01	2.50
	Heritage Collection Grade 2 6 PIN Schlage Key Blank	50 per box	YR068009	1.60
	Heritage Collection Grade 2 6 PIN Schlage Key - cut	50 per box	YR068509	2.30
	Heritage Collection Grade 2 6 PIN Schlage DO NOT COPY Key Blank	50 per box	YR068011	2.30
	Heritage Collection Grade 3 Key Blank	50 per box	YR068004	1.50
	Heritage Collection Grade 3 5 PIN KW DO NOT COPY Key Blank	50 per box	YR068010	2.30
	Heritage Collection Grade 3 Key - cut	50 per box	YR068500	1.90
	Heritage Collection Grade 3 5 PIN Schlage Key Blank	50 per box	YR068008	1.50
	Heritage Collection Grade 3 5 PIN Schlage Key - cut	50 per box	YR068508	1.90

SPECIAL KEYING CHARGE DESCRIPTION	MODEL NO	LIST PRICE
KA - Keyed Alike	KA	NC when specified
MK - Master Keyed	MK	1.50
BK - Builder Keyed*	BK	2.00
BMK - Builder Keyed and Master Keyed*	BMK	4.20
GMK - Grand Master Keyed	GMK	5.80
BKGM - Builder Keyed and Grand Master Keyed*	BKGM	6.90
K-T-P - Keyed To Pass	K-T-P	1.60
Extra Cut Keys	YR068550	2.30
	YR068500	1.90
Extra Cut Master Keys	YR068551 (6 Pin)	3.10
	YR068511 (5 Pin)	2.60
Extra Cut Builder Keys	YR068558 (6 Pin)	3.10
	YR068521 (5 Pin)	2.60

\* Builder Keyed equivalent to Construction Master Keyed.

## Master Keying Ordering

Residential Heritage Collection Master Key Order Leadsheet is a standardized form for specifying new or existing master key systems. Supports keyway selections, keying instructions, cylinder selection, stamping, and CMK orders.

To order Master Keys, please submit a separate order with the leadsheet correct information. Orders without this information may be delayed or rejected.

The leadsheet is located at the end of the pricebooks. An interactive version is also available under the Residential Heritage document section on each applicable lock's product page on the ASSA ABLOY ACCENTRA® website.

# CYLINDERS

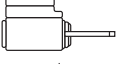
HERITAGE COLLECTION GRADE 2 & GRADE 3 CYLINDER OPTIONS			
SC-1 5-PIN STANDARD FOR Heritage Collection Grade 2 & Grade 3, 6-PIN MUST BE SPECIFIED IF NEEDED		MODEL NO	LIST PRICE
<b>5-PIN No charge when specified with Heritage Collection Grade 3 lock - compatible with F Series</b>			
	Brass Cylinder & 2 Brass Keys, Tailpiece, Low Stack, Entry, 03	YR068401	14.70
	Brass Cylinder & 2 Brass Keys, Tailpiece, Low Stack, Deadbolt, 03	YR068402	14.70
	Brass Cylinder & 2 Brass Keys, Tailpiece, Low Stack, Entry, 26	YR068405	14.70
	Brass Cylinder & 2 Brass Keys, Tailpiece, Low Stack, Deadbolt, 26	YR068406	14.70
<b>6-PIN No charge when specified with Heritage Collection Grade 2 lock - compatible with A Series</b>			
 06D01*	Brass Cylinder & 2 Brass Keys, Tailpiece, Low Stack, Entry, 03	YR068D01	16.80
	Brass Cylinder & 2 Brass Keys, Tailpiece, High Stack, Deadbolt, 03	YR068D02	16.80
	Brass Cylinder & 2 Brass Keys, Tailpiece, Low Stack, Entry, 26	YR068D05	16.80
	Brass Cylinder & 2 Brass Keys, Tailpiece, High Stack, Deadbolt, 26	YR068D06	16.80
KW-1 5-PIN STANDARD FOR Heritage Collection Grade 2, 6-PIN STANDARD FOR Heritage Collection Grade 3		MODEL NO	LIST PRICE
<b>5-PIN No charge when specified with Heritage Collection Grade 3 lock</b>			
	Brass Cylinder & 2 Brass Keys, Tailpiece, Low Stack, Entry, 03	YR060003	9.90
	Brass Cylinder & 2 Brass Keys, Tailpiece, Low Stack, Deadbolt, 03	YR060103	9.90
	Brass Cylinder & 2 Brass Keys, Tailpiece, Low Stack, Entry, 26	YR060006	9.90
	Brass Cylinder & 2 Brass Keys, Tailpiece, Low Stack, Deadbolt, 26	YR060106	9.90
<b>6-PIN No charge when specified with Heritage Collection Grade 2 lock</b>			
	Brass Cylinder & 2 Brass Keys, Tailpiece, Low Stack, Entry, 03	YR06D013	11.70
	Brass Cylinder & 2 Brass Keys, Tailpiece, Low Stack, Select Deadbolt, 03	YR06D303	11.70
	Brass Cylinder & 2 Brass Keys, Tailpiece, High Stack, Premier Deadbolt, 03	YR06D103	11.70
	Brass Cylinder & 2 Brass Keys, Tailpiece, Low Stack, Entry, 26	YR06D016	11.70
	Brass Cylinder & 2 Brass Keys, Tailpiece, Low Stack, Select Deadbolt, 26	YR06D306	11.70
	Brass Cylinder & 2 Brass Keys, Tailpiece, High Stack, Premier Deadbolt, 26	YR06D106	11.70
PARA FOR RESIDENTIAL PRODUCT ONLY		MODEL NO	LIST PRICE
<b>6-PIN</b>			
	Brass Cylinder & 2 Brass Keys, Tailpiece, High Stack, Entry Lever, 03	YR06Y303	16.80
	Brass Cylinder & 2 Brass Keys, Tailpiece, High Stack, Entry Lever, 26	YR06Y306	16.80
	Brass Cylinder & 2 Brass Keys, Tailpiece, High Stack, 83/820 Deadbolt, 03	YR06Y403	16.80
	Brass Cylinder & 2 Brass Keys, Tailpiece, High Stack, 83/820 Deadbolt, 26	YR06Y406	16.80
	Brass Cylinder & 2 Brass Keys, Tailpiece, High Stack, Premier Deadbolt, 03	YR06Y413	16.80
	Brass Cylinder & 2 Brass Keys, Tailpiece, High Stack, Premier Deadbolt, 26	YR06Y416	16.80

NOTE: For Interconnects add ICN to above part numbers (Adds Longer Interconnect tailpiece)

# ACCESSORIES REKEYING



REKEYING – KEYING KITS & REKEYING PARTS			
DESCRIPTION	QUANTITY	MODEL NO	LIST PRICE
ASSA ABLOY ACCENTRA® KW Keying Kit	Each	YR069116	128.70
ASSA ABLOY ACCENTRA® SC-1 Keying Kit	Each	YR069115	108.10
<b>KW-1 Pins</b>			
.172 – #1 Bottom Pins	100 pieces	YR065011	9.20
.195 – #2 Bottom Pins	100 pieces	YR065012	9.20
.218 – #3 Bottom Pins	100 pieces	YR065013	9.20
.241 – #4 Bottom Pins	100 pieces	YR065014	9.20
.264 – #5 Bottom Pins	100 pieces	YR065015	9.20
.287 – #6 Bottom Pins	100 pieces	YR065016	9.20
.023 – #1 Master Pins	100 pieces	YR065001	9.20
.046 – #2 Master Pins	100 pieces	YR065002	9.20
.069 – #3 Master Pins	100 pieces	YR065003	9.20
.092 – #4 Master Pins	100 pieces	YR065004	9.20
.115 – #5 Master Pins	100 pieces	YR065005	9.20
.138 – #6 Master Pins	100 pieces	YR065006	9.20
<b>SC-1 Pins</b>			
.165 – #0 Bottom Pins	100 pieces	YR065600	9.20
.180 – #1 Bottom Pins	100 pieces	YR065611	9.20
.195 – #2 Bottom Pins	100 pieces	YR065612	9.20
.210 – #3 Bottom Pins	100 pieces	YR065613	9.20
.225 – #4 Bottom Pins	100 pieces	YR065614	9.20
.240 – #5 Bottom Pins	100 pieces	YR065615	9.20
.255 – #6 Bottom Pins	100 pieces	YR065616	9.20
.270 – #7 Bottom Pins	100 pieces	YR065617	9.20
.285 – #8 Bottom Pins	100 pieces	YR065618	9.20
.300 – #9 Bottom Pins	100 pieces	YR065619	9.20
.030 – #2 Master Pins	100 pieces	YR065602	9.20
.045 – #3 Master Pins	100 pieces	YR065603	9.20
.060 – #4 Master Pins	100 pieces	YR065604	9.20
.075 – #5 Master Pins	100 pieces	YR065605	9.20
.090 – #6 Master Pins	100 pieces	YR065606	9.20
.105 – #7 Master Pins	100 pieces	YR065607	9.20
.120 – #8 Master Pins	100 pieces	YR065608	9.20
.135 – #9 Master Pins	100 pieces	YR065609	9.20
Standard Top Pin	100 pieces	YR065008	9.20
Standard Top Pin (82,84 Deadbolts)	100 pieces	YR0650D8	9.20
ASSA ABLOY ACCENTRA® Builder Key Balls	100 pieces	YR067050	13.80
Cylinder Springs (High Stack)	100 pieces	YR067001(DBLT)	5.80
Cylinder Springs (Low Stack)	100 pieces	YR067002(ENT)	5.80
C-Clips	100 pieces	YR067201	5.80
E-Clips (#820,840,83,85 Deadbolts)	100 pieces	YR067204	20.70
E-Clips (#82,84 Deadbolts)	100 pieces	YR0672D4	20.70
E-Clips (PARA Deadbolts, Cyl 820/83)	100 pieces	YR0672Y6	20.70
E-Clips (PARA Deadbolts, Cyl Premier)	100 pieces	YR0672Y5	20.70
Spring Retainer Caps (low stack)	100 pieces	YR067101	13.80
Spring Retainer Caps (high stack)	100 pieces	YR067102	13.80
Key Cut Gauge/C-Clip Tool	Each	YR069012	5.80
Plug Follower	Each	YR069001	6.30
Heritage Collection Grade2/3 Entry tailpiece	100 pieces	YR067304	21.90
Single Cylinder Tailpiece	100 pieces	YR067307	68.90
Double Cylinder Tailpiece	100 pieces	YR067308	68.90
Interconnected Cylinder Tailpiece	100 pieces	YR067307ICN	68.90

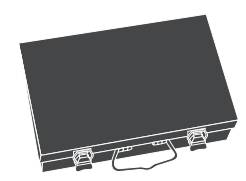

BOTTOM PIN



MASTER PIN



C-CLIP



E-CLIP  
067204

E-CLIP  
0672D4

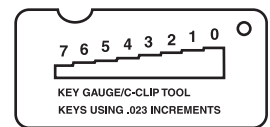

KEY CUT GAUGE



PLUG FOLLOWER

US and Canada Prices Effective February 2, 2026 / [Canada 2026 Tariff Price Adjustments](#)

# RESIDENTIAL HERITAGE COLLECTION MASTER KEY ORDER LEADSHEET

Note: Only One Leadsheet/Key System Per Purchase Order

*\*Required Information*

Acc#\* : \_\_\_\_\_ Distributor Name\* : \_\_\_\_\_ P.O. #\* : \_\_\_\_\_

End User Facility Name\* : \_\_\_\_\_ Contact Name: \_\_\_\_\_

Job/Building Name\* : \_\_\_\_\_ Phone/email: \_\_\_\_\_

End User Address\* : \_\_\_\_\_

City\* : \_\_\_\_\_ State\* : \_\_\_\_\_ Zip Code\* : \_\_\_\_\_

## Section 1: System Status

New

Existing (provide any)

System REG#\*\* : \_\_\_\_\_ Prior Order #\*\* : \_\_\_\_\_

\*\*Used to locate proper Registry # ONLY. All other order requirements must be identified in sections below.

## Section 2: System Type and Design (For New Systems ONLY)

Select System Type, Number of Pins and Level of System and add required future expansions horizontally.

Select one:

ASSA ABLOY ACCENTRA®

Kwikset

Schlage

Select one:

5 Pins

6 Pins

Top Master Key Level	Expansions →	Number of Change Keys per Master	Number of Masters per Grand	Number of Grands per Great Grand
Non (SKDs only)	Level 1 <input type="checkbox"/>		—	—
Master	***Level2 <input type="checkbox"/>		—	—
Grand	Level3 <input type="checkbox"/>			—
Great Grand	Level4 <input type="checkbox"/>			

\*\*\* For Level 2 systems ONLY, the Numbers in the Keyset Symbol comes **before** the Letters (Example: **1AA, 2AA, 3AA...**)

## Section 3: KEYWAY

If ASSA ABLOY ACCENTRA specification selected above, you can choose GA or PARA. Otherwise factory will assign keyway.

Customer Specified keyway: \_\_\_\_\_

## Section 4: CYLINDER FEATURES

Even if selected below, if applicable CMK needs to be identified on a P.O. as part of product string on every line.

Construction Lost Ball

## Section 5: CUT KEYS QUANTITIES FOR CURRENT P.O.

NO cut keys provided when keyed to Master Key(s) only or XnX type of cross keying. Otherwise default 2 keys.

**Keys per Cylinder** \_\_\_\_\_ When left blank two (2) keys per cylinder provided by default.

**Total Change Keys per Keyset** \_\_\_\_\_ If different quantities per Keyset are required please provide below.

To specify number of keys each for **Specific Keying Level** (Masters, Grands, CMK etc) use below.

GGM \_\_\_\_\_ CMK \_\_\_\_\_ Each Grand Master Key \_\_\_\_\_ Each Master Key \_\_\_\_\_

To specify number of keys for **Specific Keyset** use below.

Keyset & QTY	Keyset & QTY	Keyset & QTY	Keyset & QTY	Keyset & QTY	Keyset & QTY	Keyset & QTY

# RESIDENTIAL HERITAGE COLLECTION MASTER KEY ORDER LEADSHEET (CONT.)



P.O. #\* : \_\_\_\_\_

**Section 6: CROSS KEYING**  
*All Cross Keyed Cylinders need to have keysets with leading "X" on P.O. Example: XAA1. Provide conditions below.*

Keyset		Operated by Conditions
	OBY	
	OBY	

Keyset		Operated by Conditions
	OBY	
	OBY	

**Section 7: STAMPING REQUIREMENTS**  
*Default stamping will apply unless specified below.*

**Cut Keys Stamping**

Select one below:

- Bitting
- Keyset
- Alternate
- None. Blank.

Do Not Duplicate - Die Stamp

**Cylinders Stamping**

Select one below:

- Bitting
- Keyset
- Alternate

Select location:

- Visual
- Concealed

**Section 8: SHIPPING INSTRUCTIONS**  
*(if other than what is listed on P.O.)*

**Master Keys:**

Name: \_\_\_\_\_ Address: \_\_\_\_\_

Att To: \_\_\_\_\_ City: \_\_\_\_\_ State: \_\_\_\_\_ Zip: \_\_\_\_\_

**Construction Master (CMK):**

Name: \_\_\_\_\_ Address: \_\_\_\_\_

Att To: \_\_\_\_\_ City: \_\_\_\_\_ State: \_\_\_\_\_ Zip: \_\_\_\_\_

**Provide additional comments below :**

# NOTES



The ASSA ABLOY Group is the global leader in access solutions.  
Every day, we help billions of people experience a more open world.

ASSA ABLOY Opening Solutions leads the development within door openings and products for access solutions in homes, businesses and institutions. Our offering includes doors, frames, door and window hardware, mechanical and smart locks, access control and service.

**ACCENTRA®**  
**ASSA ABLOY**

**TECHNICAL SUPPORT**

(troubleshooting, product use and application, returns)

Tel: 855-557-5078

Email: [techsupport.accentra@assaabloy.com](mailto:techsupport.accentra@assaabloy.com)

**CUSTOMER SUPPORT**

(orders, product configuration, pricing, lead-time)

Tel: 855-557-5078 x2

Email: [Customerservice.Accentra@assaabloy.com](mailto:Customerservice.Accentra@assaabloy.com)

**U.S.A.:**

**ASSA ABLOY ACCENTRA®**

225 Episcopal Road

Berlin, CT 06037-4004

Tel: 1-800-438-1951

Fax: 1-800-338-0965

[www.accentra-assaabloy.com](http://www.accentra-assaabloy.com)