

COMMERCIAL PRICE LIST

#41

US and Canada Prices Effective March 3, 2025



TOOLS AND RULES

ASSA ABLOY Door Security Solutions® Customer Service
 Business Hours & Holiday Schedule..... 4
 Finish Chart..... 4
 ASSA ABLOY FlashShip® Program and Locations..... 5
 Ordering Tips..... 6
 Check List When Placing an Order..... 6
 Key Definitions and Stamping Rules..... 7
 Order Forms
 Factory Non-Keyed..... 8
 Stock Condensed..... 9
 Master Keyed..... 10-14
 Key Systems Information Request Form..... 15
 Ebusiness..... 16
 On-Line Order Entry..... 17
 Fax Program..... 17
 Terms and Conditions..... 18-20
 Limited Warranty..... 21
 Merchandising Aids/Display Mounts..... 23- 24

CYLINDERS/KEYS/KEYING

Key Systems Security Policy..... 25
 Customer Bittings and Sample Keys/Cross Keying..... 25
 Bitting List Charges..... 26
 Simple K..... 26
 Keying Charges and Keys..... 27
 Stamping Charges..... 28
 Key Blanks and Cut Keys..... 29-30
 Construction Core Program..... 31
 Cylinders
 Component (Cylindrical Lock)..... 32
 Fixed Core Mortise..... 33
 Deadlock..... 33
 Fixed Core Rim..... 34
 Electrical Switch..... 34
 Hotel..... 34
 Thumbturn..... 34
 Interchangeable Core..... 35
 Cores..... 35
 Housing Assemblies..... 36
 Rings..... 36
 Plugs/Shells..... 36
 Security (all types)..... 37-38
 High Security (UL437)..... 39
 Security Keys..... 39
 Keying Kits..... 40
 Cams..... 41
 Cylinder/Miscellaneous Parts..... 40-42
 ACCENTRA KeyMark® Keying Charges, Keys and Key Blanks..... 43
 ACCENTRA KeyMark® Cylinders, Cores and Housings..... 44
 ACCENTRA KeyMark® Cylinder Parts and Accessories..... 45-46
 ACCENTRA KeyMark® Tools and Service Equipment..... 46

8800 SERIES/GRADE 1/MORTISE LOCKS

Variations..... 47
 8800FL Series Mortise Locks with Lever Trim..... 48-52
 8800 Series Mortise Locks with Knob Trim..... 53-54
 8800FL Series Mortise Deadlocks
 with A/F Cylinders & Thumbturns..... 55
 8800 Series Mortise Lock Components..... 56
 8800(FL) Series Mortise Lock Bodies..... 57
 Trim Packs (Standard Lever Designs)..... 58
 Parts..... 59-62
 8800FL Series Electrified Mortise Locks
 with Lever Trim..... 63-65

8800FL Series Electrified Mortise Lock Bodies..... 66
 SL8800FL Series Security Mortise Locks with Lever Trim..... 67-68

REFLECTIONS® SERIES MORTISE TRIM

Variations..... 69
 8800RL Series Mortise Locks..... 70-71
 8800RL Series Mortise Lock Bodies/Trim Packs..... 72
 8800RL Series Trim Parts..... 73
 8800RL Series Electrified Mortise Locks..... 74
 8800RL Series Electrified Mortise Lock Bodies..... 75

COMPETITOR MORTISE INDICATOR KITS

YPL SERIES GRADE 1 INDICATOR LOCKS
 Variations..... 79
 Lever Designs, Parts..... 80

5400LN SERIES/GRADE 1/CYLINDRICAL LEVER LOCKS

Variations..... 81
 5400LN Series Cylindrical Locks..... 82
 5400LN Series Electrified Cylindrical Locks..... 83
 Parts..... 84-86

5400CK SERIES/GRADE 1/CYLINDRICAL KNOB LOCKS

Variations..... 87
 5400CK Series Cylindrical Locks..... 88
 Parts..... 89

5300LN SERIES/GRADE 2/CYLINDRICAL LEVER LOCKS

Variations..... 91
 5300LN Series Cylindrical Locks..... 92
 5300LN Series Electrified Cylindrical Locks..... 93
 Parts..... 94-96

4700LN SERIES/GRADE 1/CYLINDRICAL LOCKS

Variations..... 97
 4700LN Series Cylindrical Lever Locks..... 98
 4700LN Series Electrified Cylindrical Locks..... 99
 Parts and Cylinders..... 100

4600LN & 4600YC SERIES/GRADE 2/CYLINDRICAL LOCKS

Variations..... 101
 4600LN Series Cylindrical Lever Locks..... 102
 4600YC Series Cylindrical Knob Locks..... 102
 Parts and Cylinders..... 102

RL SERIES/TUBULAR LEVER LOCKS

Variations..... 103
 RL Series Tubular Locks..... 104
 Parts..... 104

AUXILIARY LOCKS/PADLOCKS

D100/D200 Series Cylindrical Deadbolts Variations..... 105
 D100 & D200 Series..... 106
 D100 And D200 Series Parts And Accessories..... 107
 350 Series/Padlocks/Auxiliary Locks/Variations..... 108
 350 Series Mortise Deadlocks..... 109
 Auxiliary Latch..... 109
 Auxiliary Locks..... 110
 Padlocks
 PD400 Series..... 111
 PD500 Series..... 112
 PD600 Series..... 113

TABLE OF CONTENTS

7000 SERIES/ARCHITECTURAL EXIT DEVICES

Variations..... 115
 How to Order..... 116
 Mechanical Options..... 117
 7100 Series Exit Devices..... 117
 7100 Series Trim..... 118-120
 7130 Series Mortise Exit Devices..... 121
 7130 Series Trim..... 122
 7200 Series Narrow Stile Exit Devices..... 123
 7200 Series Trim..... 124
 7000 Series Electrified Exit Devices Options..... 125
 7000 Series Alarm Kits..... 125
 7000 Series Delayed Egress..... 126
 Cylinders..... 127-128
 Miscellaneous..... 128-130
 Removable Mullions..... 131-132

6000 SERIES/ARCHITECTURAL EXIT DEVICES

Variations..... 133
 How to Order..... 124
 Mechanical Options..... 135
 6100ED Series Exit Devices..... 135
 6100ED Series Trim..... 136-138
 6130ED Series Mortise Exit Devices..... 139
 6130ED Series Trim..... 140
 6200 Series Narrow Stile Exit Devices..... 141
 6200 Series Trim..... 142
 6000 Series Electrified Exit Devices Options..... 143
 6000 Series Alarm Kits..... 143
 Cylinders..... 144-145
 Miscellaneous..... 146-147
 Removable Mullions..... 148-149

2100 SERIES/FLATBAR EXIT DEVICES

Variations..... 151
 How to Order..... 152
 2100 Series Exit Devices..... 153
 2100 Series Trim..... 154-155
 Cylinders..... 156
 Miscellaneous..... 157
 Removable Mullions..... 158

1800 SERIES/FLATBAR EXIT DEVICES

Variations..... 159
 How to Order..... 160
 1800 Series Exit Devices..... 161
 1800 Series Trims..... 161
 Cylinders and Miscellaneous..... 162
 Mullions..... 163
 Mullion Parts..... 163

1500 SERIES/TRADITIONAL EXIT DEVICES

Variations..... 165
 How to Order..... 166
 1500 Series Exit Devices..... 167
 1500 Series Trim..... 168-169
 Cylinders..... 170
 Miscellaneous..... 171
 Removable Mullions..... 172

5800 SERIES/CAST IRON DOOR CLOSERS

5800 Series Door Closers and Parts..... 173

4400 SERIES / INSTITUTIONAL DOOR CLOSERS

Variations..... 175
 4400/4400S Series Closers..... 176
 Accessories..... 177
 Closer Bodies and Screw Packages..... 178
 Arms and Arm Assemblies..... 179-182
 Track Assemblies and Parts..... 183

3000 SERIES / ARCHITECTURAL DOOR CLOSERS

Variations..... 185
 3101/3301 Series Closers..... 186
 3501 Series Closers..... 187
 Accessories..... 188
 Closer Bodies and Screw Packages..... 189
 Arms and Arm Assemblies..... 190-192

2700 SERIES / ARCHITECTURAL DOOR CLOSERS

2700 Series Door Closer and Parts..... 193

51 SERIES / INDUSTRIAL DOOR CLOSERS

Variations..... 195
 51 Series Closer..... 196
 Accessories..... 197
 Closer Bodies and Screw Packages..... 198
 Arms and Arm Assemblies..... 199

1100 SERIES / INDUSTRIAL DOOR CLOSERS

1100 Series Door Closer and Parts..... 200

1900 SERIES / TRADITIONAL DOOR CLOSERS

Variations..... 201
 1900 Series Closers and Accessories..... 202
 Arms and Arm Assemblies..... 203
 Screw Packages..... 204

YDC200 SERIES / ECONOMY DOOR CLOSERS

YDC200 Series Door Closer and Parts..... 205

ELECTRIFIED PRODUCTS

Door Alarm
 SDA16 Door Alarm, Options and Cylinders..... 207
 Accessories..... 208
 nexTouch® Cylindrical Lock..... 209
 Variations..... 209
 Cylinders..... 210
 Accessories..... 211
 nexTouch® Sectional Mortise Lock
 Variations..... 213
 Lock Body..... 215
 Cylinders..... 216
 Accessories..... 217
 nexTouch® Exit Trim
 Variations..... 219
 Lock Body..... 220
 Cylinders..... 221
 Accessories..... 222

ASSA ABLOY ACCENTRA™ CUSTOMER SERVICE

8:00AM – 6:00PM M-Th (Eastern)
8:00AM – 5:00PM Fr (Eastern)
225 Episcopal Road
Berlin, CT 06037-4004
Telephone: (855) 557-5078
Fax #: (860) 338-0965
customerservice.accentra@assaabloy.com
orders.accentra@assaabloy.com

TECHNICAL PRODUCT SUPPORT

8:00 a.m. – 4:30 p.m. (Eastern)
Telephone #: (855) 557-5078
techsupport.accentra@assaabloy.com

ELECTRIFIED TECHNICAL PRODUCT SUPPORT

8:00 a.m. – 4:30 p.m. (Eastern)
Telephone #: (800) 810-WIRE (9473)
Fax #: (203) 603-5981

SPECIFIC WHO'S WHO CONTACTS

<https://content.assaabloyusa.com/doc/AADSS1217921>

ASSA ABLOY DOOR SECURITY SOLUTIONS CANADA CUSTOMER SERVICE - VAUGHAN

8:00 a.m. – 4:30 p.m. (Eastern)
160 Four Valley Drive
Vaughan ON L4K 4T9
Telephone #: (800) 461-3007
Fax #: (800) 461-8989

HOLIDAY SCHEDULE*

ASSA ABLOY ACCENTRA™ Customer Service - will be CLOSED on the following holidays:

- January 1, 2025
- February 17, 2025
- April 18, 2025
- May 26, 2025
- July 4, 2025
- September 1, 2025
- November 27, 2025
- November 28, 2025
- December 24, 2025
- December 25, 2025
- December 26, 2025

ASSA ABLOY Door Security Solutions Customer Service - Vaughan

- January 1, 2025
- February 17, 2025
- April 18, 2025
- May 19, 2025
- July 1, 2025
- August 4, 2025
- September 1, 2025
- October 13, 2025
- December 24, 2025
- December 25, 2025
- December 26, 2025
- December 31, 2025

Technical Product Support will be CLOSED on the following holidays:

- January 1, 2025
- February 17, 2025
- April 18, 2025
- May 26, 2025
- July 4, 2025
- September 1, 2025
- November 27, 2025
- November 28, 2025
- December 24, 2025
- December 25, 2025
- December 26, 2025

*Dates subject to change.

FINISH CHART

ANSI/BHMA CODE	FINISH DESCRIPTION
600	Primed for Painting
605	Bright Brass, Clear Coated
606	Satin Brass, Clear Coated
611	Bright Bronze, Clear Coated
612	Satin Bronze, Clear Coated
613E	Dark Oxidized Satin Bronze - equivalent
618	Bright Nickel Plated, Clear Coated
619	Satin Nickel Plated, Clear Coated
625	Bright Chrome Plated
626	Satin Chrome Plated
629	Bright Stainless Steel

ANSI/BHMA CODE	FINISH DESCRIPTION
630	Satin Stainless Steel
689	Aluminum Painted
690	Dark Bronze Painted
691	Light Bronze Painted
693	Black Painted
694	Medium Bronze Painted
695	Dark Bronze Painted
696	Satin Brass Painted
BSP	Black Suede Powder Coat
WSP	White Suede Powder Coat

SPECIAL FINISHES:

<p>* Contact factory for availability * 50 piece minimum order for non-standard sprayed or powder coat finishes. Additional charge per closer will be added to net/net charge</p>	<p>Net add \$55.00 per closer</p>
---	-----------------------------------

7 Brands...One Invoice in a Flash!

Note that some products may not be available in Canada as well as some of the programs offered in this price book may differ between the USA and Canada.

Please contact your sales representative for more information.

The ASSA ABLOY FlashShip® program, with products from your favorite brands of ASSA ABLOY ACCENTRA™, Markar, McKinney, Norton, Pemko, Rixson and Rockwood, offers the convenience of placing ONE purchase order coupled with 24-hour processing. Same day order entry and eligibility for buying program discounts makes this your one-stop for these popular products!

What types of products are available on the FlashShip program?

- Markar, McKinney and Pemko continuous and architectural hinges
- Pemko thresholds, gasketing, and aluminum geared hinges
- Rixson pivots, stops and holders
- Rockwood door hardware and trim
- Norton door controls
- ACCENTRA mortise locks, Grade 1 and Grade 2 cylindrical locks/deadbolts, exit devices, door closers, nexTouch® keypad access locks and others

How do I place an order?

FlashShip WebShop

FlashShip WebShop makes ordering your favorite ASSA ABLOY products easier than ever before. Enhancements include:

- User-friendly interface for simplified navigation
- High resolution product images for easy identification
- Several ways to shop: search by keyword or filter by product type
- Streamlined order & payment processing for quick checkout
- Saved order history - reorder in just a few clicks
- Helpful ordering tools including Quick Order, multiple carts, and lists

Traditional Order Submittal.

1. Use the FlashShip Order Form found in the current FlashShip program catalog OR prominently indicate "FlashShip Program" on purchase order
2. Use the part numbers listed in the FlashShip catalog to indicate products
3. Fax all orders to 877-888-2772 or email to FlashShip@assaabloy.com

Notes:

- Minimum order is \$100
- Prepaid freight on orders over \$1,750
- Only products listed in the FlashShip program catalog are eligible
- Reference the program catalog for a complete list of Terms & Conditions

FlashShip®



ASSA ABLOY FLASHSHIP® LOCATIONS

1-877-888-2772
FlashShip@assaabloy.com

FlashShip East
at ASSA ABLOY
New England Service Center
225 Episcopal Rd.
Berlin, CT 06037

FlashShip South
at ASSA ABLOY
Southeast Service Center
825 Riverside Parkway
Suite 100
Austell, GA 30168

FlashShip Kent
at ASSA ABLOY
Pacific Northwest Service Center
20112 72nd Ave S
Kent, WA 98032

FlashShip Orlando
2675 Directors Row
Orlando, FL 32809

FlashShip West
5678 Concours
Ontario, CA 91764

FlashShip Chicago
235 East Lies Road
Carol Stream, IL 60188

FlashShip Dallas
1451 Interstate 30
Mesquite, TX 75150

FlashShip Mid Atlantic
7071 Dorsey Run Road
Elkridge, MD 21075

FlashShip Houston
5500 N Sam Houston Pkwy W
Suite 300
Houston, TX 77086

FlashShip Hayward
26235 Research Rd.
Hayward, CA. 94545

ORDERING TIPS

- Please submit ASSA ABLOY FlashShip® Product Orders and Plant Product Orders on separate order forms.
- Please use FlashShip® Order Forms for all FlashShip® Product Orders and include FlashShip® Part Numbers.
- Order Forms are included in the ACCENTRA Price Book and at www.accentra-assaabloy.com.
- Please include Job Name and Registry Number for all contract orders.
- Keyed Lead Sheets A and B are required for contract orders that require Master Keying.
- Remember to include Keysets on all contract orders.
- Be sure to include Handing for mortise locks and exit devices.
- Be sure to include Design.
- Be sure to include Finish.

ORDERING TIP ADMINISTRATIVE DOCUMENTATION

When submitting purchase orders for processing, please remember that certain cylinder types and/or keyways require additional administrative documentation before the order can be entered.

Purchase orders will be held and questioned if the following keyway/cylinder types do not have the proper administrative documentation submitted with each purchase order:

- ACCENTRA KeyMark® products
- Security cylinders and keys
- High security cylinders and keys

All of the above product types must be accompanied by additional administrative documents unless they are shipping direct to the end user facility. These administrative documents include, but may not be limited to, the following:

- Letter of Authorization – must be submitted on the end user facility letterhead, dated and signed by an authorized individual from the facility. Letter must be quantity-specific for certain product types. ACCENTRA does not keep letters of authorization on file.

CHECKLIST

Before placing your order, check for the following ...

- Purchase Order on Company Letterhead
- Purchase Order is Legible
- Purchase Order Number
- Account Number
- Ship To Address
- Contact Person for additional information requirements
- Pricing Requirements – Buying Program or Quote (please attach)
- FlashShip® Order (FlashShip® Order Form or FlashShip® #'s Included)
- Contract Order (Keyed Lead Sheets attached)
- Keysets for ALL Keyed Product
- Handing (if applicable)
- Design (if applicable)
- Backset & Strike (if applicable)
- Finish (if applicable)

KEY STAMPING DEFINITIONS AND RULES

Below are stamping codes and their definitions:

Code	Definition
VKC0	No keyset, registry number, or bitting stamping any keys. Includes master keys and change keys. Keys will be stamped with keyway designation. (Keys will be tagged.)
VKC1	Master keys stamped with their keyset symbol and registry number. Change keys stamped with their keyset symbol. (Standard for high security, security and ACCENTRA KeyMark® cylinders.)
VKC2	Master keys stamped with their keyset symbol and registry number. Change keys stamped with their keyset symbol. Cylinders stamped with their keyset symbol on the face of the plug. (Not available for high security cylinders, security cylinders or ACCENTRA KeyMark.)
VKC3	Master keys stamped with their keyset symbol and registry number. Change keys stamped with their bitting. Cylinders stamped with their keyset symbol on the face of the plug. (Not available for high security cylinders, security cylinders or ACCENTRA KeyMark.)
CKC2	Master keys stamped with their keyset symbol and registry number. Change keys stamped with their keyset symbol. Cylinders stamped with their keyset symbol in a concealed location.
CKC3	Master keys stamped with their keyset symbol and registry number. Change keys stamped with their bitting. Cylinders stamped with their keyset symbol in a concealed location. (Not available for high security cylinders, security cylinders or ACCENTRA KeyMark.)

The following examples indicate what will be stamped on the thumb (logo) side of the keys when the codes are used. (Thumb side is determined by holding the key normally in your right hand.)

1. KEYS FOR MASTER KEYED CYLINDERS

A. Master Keys:

Code	Stamping	Location	Example
VKC0	NONE	-----	Keys will be tagged
VKC1, VKC2, VKC3, CKC3, or CKC3	Registry Number Keyset	Top Line Bottom Line	R69596 GMA
No VKC or CKC	Registry Number Keyset	Top Line Bottom Line	R69596 GMA

B. Change Keys:

Code	Stamping	Location	Example
VKC0	NONE	-----	Keys will be tagged
VKC1, VKC2 or CKC2	Keyset NONE	Top Line Bottom Line	AA1
VKC3, CKC3 or No VKC, No CKC	System + Bitting NONE	Top Line Bottom Line	E253653

2. CHANGE KEYS FOR KEYED RANDOM CYLINDERS

Code	Stamping	Location	Example
N/A	System + Bitting NONE	Top Line Bottom Line	E253653

3. CHANGE KEYS FOR 0-BITTED CYLINDERS

Code	Stamping	Location	Example
	NONE		

In addition, other standard practices for stamping ACCENTRA keys are:

- For all ACCENTRA keys the keyway is stamped on the index finger side (non-logo side) of the key.
- The keyway will not be stamped on the key for stock keyway (Para), or keys for security cylinder, high security cylinders or ACCENTRA KeyMark®.
- "Do Not Duplicate" or any special stamping will be stamped on the index finger side (non-logo side) of the key.
- The ACCENTRA logo is standard on all keys unless otherwise requested.
- VKC1 is standard for all keys for high security cylinders, security cylinders and ACCENTRA KeyMark.
- VKC2, VKC3 or CKC3 is not available with high security cylinders, security cylinders or ACCENTRA KeyMark.
- All ACCENTRA KeyMark keys are coined on the index finger side of the key with the ACCENTRA logo. All stamping is done on the thumb side.

Note: Only One Leadsheet/Key System Per Purchase Order

*Required Information

Acc#*: _____ Distributor Name*: _____ P.O. #*: _____

End User Facility Name*: _____ Contact Name: _____

Job/Building Name*: _____ Phone/email: _____

End User Address*: _____

City*: _____ State*: _____ Zip Code*: _____

Section 1: System Status

- New
- Existing (provide any below)

REG#**: _____ TMK Bitting and Keyway **: _____ Prior Order #**: _____

**Used to locate proper Registry # ONLY. All other order requirements must be identified in sections below.
For Order with Field Specified Bittings provide information with PO. See Price Book for possible extra charges.

Section 2: System Type and Design (For New Systems ONLY)

Select System Type, Number of Pins and Level of System and add required future expansions horizontally.
To Select Cylinder Features See Section #6
For Actual Cut Key quantities see Section #7

- Conventional
(ACCENTRA Std, IC, SEC)
- ACCENTRA KeyMark®
- SFIC A2
- SFIC A4
- 5 Pins
- 6 Pins
- 7 Pins

Expansions →	Number of Change Keys per Master	Number of Masters per Grand	Number of Grands per Great Grand	Top Master Key Level
Level 1 <input type="checkbox"/>		—	—	—
***Level2 <input type="checkbox"/>		—	—	Master
Level3 <input type="checkbox"/>			—	Grand
Level4 <input type="checkbox"/>				Great Grand

*** For Level 2 systems ONLY, the Numbers in the Keyset Symbol comes **before** the Letters (Example: 1AA, 2AA, 3AA...)

Section 3: KEYWAY

ASSA ABLOY ACCENTRA™ Manufacturing will assign keyways unless customer specific keyway is noted below.
Use of High Security and ACCENTRA KeyMark® keyways have to be pre-authorized by ACCENTRA Key Record

Customer Specified keyway: _____

Section 4: CROSS KEYING

All Cross Keyed Cylinders need to have keysets with leading "X" on P.O. Example: XAA1
For all Cross Keyed Cylinders, Keysets Operated By (OBY) conditions need to be provided below.

Keyset	Operated By Conditions	Keyset	Operated By Conditions

Section 5: AUTHORIZATION

Security, High Security and ACCENTRA KeyMark® Products Require Authorization
For **NEW** ACCENTRA KeyMark® systems include the **System Information Document** with your P.O.

[Click here for template](#)

For **EXISTING** systems, if cylinders, keys, keyblanks or bitting lists are NOT shipping directly to end user, please provide authorization documents in the form of Letter of Authorization (LOA) or through the ROA Portal

MASTER KEY ORDER LEADSHEET (CONT.)

P.O. #* : _____

Section 9: PACKING INSTRUCTIONS FOR KEYS PRODUCED with PRODUCT

When ordered as CMK keys will be packed and shipped separately from product at no charge

- Pack Keys with Product (Standard) Pack Keys Separately - see Price Book for charges

Section 10: SHIPPING INSTRUCTIONS FOR CHANGE KEYS

Name: _____ Address: _____

Att To: _____ City: _____ State: _____ Zip: _____

**Section 11: SHIPPING INSTRUCTIONS FOR ANY LEVEL MASTER KEYS
(Includes GGGM, GGM, GM, Masters, Sub Masters, Control and Emergency Keys)**

Name: _____ Address: _____

Att To: _____ City: _____ State: _____ Zip: _____

Section 12: SHIPPING INSTRUCTIONS FOR CONSTRUCTION MASTER KEYS (MK'ed or TEMPs)

Name: _____ Address: _____

Att To: _____ City: _____ State: _____ Zip: _____

Section 13: SHIPPING INSTRUCTIONS FOR KEYBLANKS

Name: _____ Address: _____

Att To: _____ City: _____ State: _____ Zip: _____

Section 14: SHIPPING INSTRUCTIONS FOR CORES

Name: _____ Address: _____

Att To: _____ City: _____ State: _____ Zip: _____

Section 15: SHIPPING INSTRUCTIONS FOR BITTING LIST

If Bitting List is required, please mark how you want to receive them and provide shipping instructions

- Include Keysets that were ordered with product on this PO (no charge)
 Expanded bitting list. See Price Book for additional charges (Please provide requirements): _____

- Excel (via EMAIL) PDF (via EMAIL) Paper (via UPS)

E-mail: _____ Att To: _____

Name: _____ Address: _____

Att To: _____ City: _____ State: _____ Zip: _____

Section 16: SHIPPING INSTRUCTIONS FOR KEY WIZARD or SIMPLE K DOWNLOAD FILES

Download files are delivered via email.

If Download file is required, please mark below and provide shipping instructions

- Include Keysets that were ordered with product on this PO
 Expanded list (Please provide requirements): _____

E-mail (for download files) _____

Section 17: CONTACT INFORMATION FOR INDIVIDUAL COMPLETING THIS FORM

Name: _____

Phone: _____

E-mail: _____

KEY SYSTEMS INFORMATION REQUEST FORM

Please fax to Key Systems Administration @ 800-338-0965

Date: _____

Key Systems Information

*Registry Number: _____

*Job Name and Location: _____

*Keyway: _____ Top Master Key Bitting: _____

Any Other Known System Information:

Information Requested:

Requested By: _____

Phone: _____ Fax: _____ Email: _____

Agency/Distributor Name: _____

Key System Administration Response:

Please attach a Letter of Authorization from the end user if requesting bitting information.
***Required Information**

Manage every aspect of your ASSA ABLOY account all in one place --- <https://connect.assaabloy.com> (login & new user registration)

Orders

- Order management
- Expedite request status
- Customer Care Forms (CCF) status
- Return Goods Authorization (RGA) status
- CCF and RGA requests
- Access to all marketing and technical collateral

Billing and Credit

- Invoices
- Payments
- Credit memos
- Account statements

Online Orders:

- Online order entry
- ASSA ABLOY FlashShip® webshop

Project Management

- Consolidated quotes
- Projects
- Keying consultation

Sales and Reporting

- Monthly sales
- Sales program reporting

Other Important Info

- Order guidelines
- Policies and procedures
- Buying programs
- Lead times

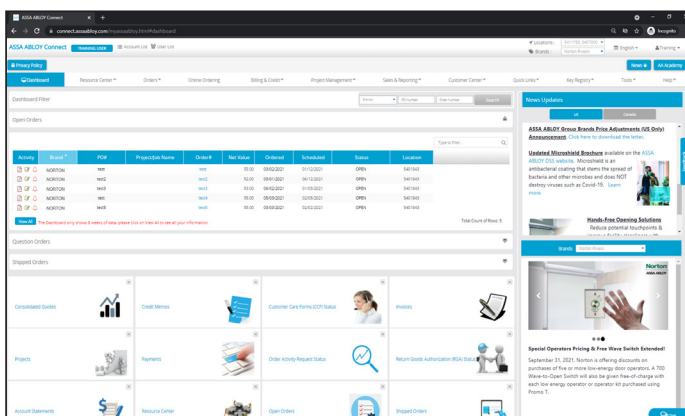
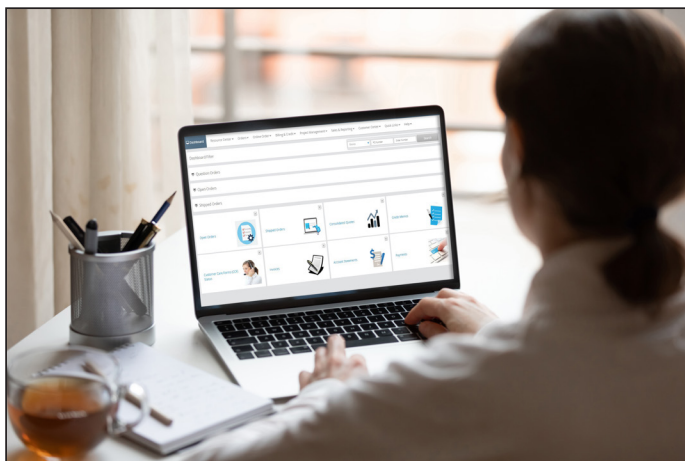

WEBSITE

The latest product information, documentation and support tools are posted on www.accentra-assaabloy.com, including:

- Catalogs
- Price Book
- Installation Instructions
- Templates
- Wiring Diagrams
- Warranties
- Brochures & Sell Sheets
- Videos

The ASSA ABLOY Key System Design Studio is an online portal that walks the user step-by-step through the master key system design process. With intuitive customer interface and enhanced features, the Key System Design Studio eliminates missing information, speeding up system creation and order processing. The system asks the user to answer specific questions about the systems parameters and functionality, ensuring that all required information is captured and that the system created is optimized for the customer's needs.

Benefits:

- Eliminates need to fill out paper forms with easy to use online portal
- Eliminates missing information which can delay system creation and order processing
- Streamlines the master key system request process with intuitive user interface

Features:

- **Drag and drop keying tree** – easily sort and change keying tree to desired configuration
- **Dynamic upload** – users can upload their own door and key schedules for automatic population into a new system
- **Dynamic download** – users can download systems they have created any time without having to contact the master key department
- **Easy order submission** - save processing time by submitting product order along with the system request.

To access the Key System Design Studio:

Visit ASSA ABLOY Connect at <https://connect.assaabloy.com/>. (New users must register for an account)

For assistance or a demonstration, contact ASSA ABLOY Customer Support at 1-800-377-3948.

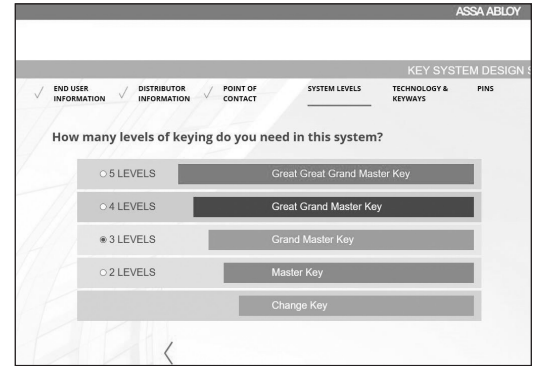

Select desired system parameters



Download system schematic or doors list

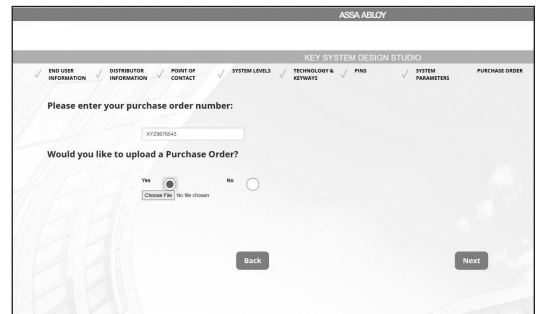

Submit product order along with system request

ACCEPTANCE

ASSA ABLOY ACCENTRA™ reserves the right to decline an order, in whole or in part, when the type or quantity of goods or credit worthiness of the Purchaser is not satisfactory to us in our sole and absolute discretion.

Purchase Orders, Quote requests, Acknowledgements or the like issued by the Purchaser that have contrary standard terms and conditions are not binding on ASSA ABLOY ACCENTRA™, unless such terms and conditions are approved in a separate written agreement by ASSA ABLOY ACCENTRA™ authorized representatives. In the event of an acceptance of Purchaser's Purchase Order by ASSA ABLOY ACCENTRA™, the Purchaser agrees that such acceptance is solely conditioned on Purchaser's acceptance of the terms and conditions set forth in this instrument, regardless of the terms and conditions specified in Purchaser's Purchase Order. The terms and conditions in Purchaser's Purchase Order which conflict with the terms and conditions of this instrument shall be disregarded and are hereby rejected, and this instrument shall constitute the entire agreement between ASSA ABLOY ACCENTRA™ and the Purchaser.

In the event that ASSA ABLOY ACCENTRA™ does not enforce or require strict performance of any term or condition hereof, or of any other document, instrument or other agreement relating to goods sold, such lack of enforcement or requirement of strict performance will not waive, affect or diminish any right of ASSA ABLOY ACCENTRA™ to enforce or require strict performance of such term or condition in the future.

PRICES

All prices are subject to change without notice and are not guaranteed.

Possession of this price list does not constitute an agreement to sell. We reserve the right to correct any errors at any time.

TERMS

Invoices dated the 1st through the 15th will be due for 2% discount on the *10th of the following month. Invoices dated the 16th through the 31st will be due for 2% discount on the *25th of the following month. *Net immediately thereafter. (ASSA ABLOY ACCENTRA™ retains the right to sell or to decline to sell to any Customer for any reason whatsoever that in its judgment is deemed sufficient.)

It is understood that ASSA ABLOY ACCENTRA™ may impose and charge a finance charge which is the lesser of one and one-half percent (1-1/2%) per month or the highest rate allowed by law on any amount which becomes past due and delinquent. Additionally the Customer shall be responsible for all collection costs, court costs and reasonable attorney's fees (where allowed by law) in connection with the recovery of any delinquent amount.

FREIGHT

All orders are shipped FOB factory/warehouse, except as expressly provided below. When delivered to the Transportation Company, the Purchaser assumes the risk of loss or damage in transit.

Customer orders with net product value in excess of \$7,000.00 will be shipped prepaid by the ASSA ABLOY ACCENTRA™ carrier of choice to a single destination point in the United States.

Customer orders with net product value less than \$7,000.00 will be shipped prepaid by the ASSA ABLOY ACCENTRA™ carrier of choice and freight and handling charges will be added to the customer's invoice. A minimum freight and handling charge of \$15.00 will be charged on orders with net product value of \$400.00 or less. The minimum freight and handling charge will not apply to orders for only Cut (bitted) keys of any type, Master keys, Master keyed cylinders or padlocks and factory generated biting lists that do not have any other product types included on the order. Freight on these orders will be charged as the percentage of invoice value.

For orders with net product value greater than \$400.00 and less than \$7,000.00, freight charges will be calculated as a percentage of the net invoice value and will be added to Customer's invoice. The percentage is based on the National U.S. Average On Highway Diesel Fuel Prices as reported by the US Department of Energy in effect at the beginning of each month. The new rate will be published on the ASSA ABLOY ACCENTRA™ extranet and will go into effect for shipments beginning on the 1st day of the month. Please refer to the extranet for the rate chart and information on the current freight charge percentage.

Great Grand Master keys, Grand Master keys, Master keys, Construction Master keys, Control Keys, and Change Keys which are shipped separate from customer order for security reasons, on orders with total net product value in excess of \$7,000.00 will be shipped prepaid by the ASSA ABLOY ACCENTRA™ carrier of choice. If the total order value is less than \$7,000.00, the shipping charges will be added to Customer's invoice.

If a customer provides their own freight account number for the freight charges, ASSA ABLOY ACCENTRA™ will apply a handling fee of \$25.00 to the invoice.

Expedited shipping options – If the customer requests an expedited method of shipment such as "Next Day Air" the charges will be prepaid by ASSA ABLOY ACCENTRA™ and the full rate for the service, as published by the carrier, will be added to the customer's invoice.

Packing – ASSA ABLOY ACCENTRA™ will pack, mark and ship the products according to its standard procedures for shipment, unless the parties agree, in writing, that ASSA ABLOY ACCENTRA™ will comply with any special instructions provided by the customer. Special instructions must be submitted, in writing, at time of order placement. Compliance with special instructions may result in an increased price.

MINIMUM ORDER

Minimum order value for complete product is \$250.00 net product value. The minimum order value for parts orders is \$100.00 net product value. In the event that the net product value does not meet the required net minimum, ASSA ABLOY ACCENTRA™ may, at its sole discretion (a) apply a minimum order charge, (b) reject the order or (c) waive the minimum requirement provided that the waiver of the requirement for one order shall not constitute a waiver of the requirement for any future orders.

The following products are exempt from this policy: Cut (bitted) keys of any type, Master keys, Master keyed cylinders or padlocks and factory generated biting lists.

QUOTATIONS

If ASSA ABLOY ACCENTRA™ elects to offer a quote, such quote will be valid until the expiration date on that quote. Complete shipment of the order must be accepted by Purchaser within standard lead times. Only one quote is accepted per purchase order.

The quote number must be referenced on the purchase order. Any invoiced order that has the incorrect discount applied to it and did not have the quote number written on the order will have a service fee of \$100.00 net DEDUCTED from any sales credit issued for the difference in discount.

The quote is null and void if the Purchase Order does not include ALL product lines listed on the quote or if the quantities for any item covered by the quote deviate by 10% or more.

With the issuance and acceptance of a quote for the purchase of products, the Purchaser agrees that products so purchased will not be resold or transferred to any Distributor not authorized by ASSA ABLOY ACCENTRA™ to sell its products. This would be inclusive of branches of the quoted Distributor. Failure to abide by this restriction may result in the Distributor's ineligibility for Quotations, or other actions at ASSA ABLOY ACCENTRA™ discretion.

ASSA ABLOY ACCENTRA™ and its sales representatives reserve the right, in their sole discretion and for any reason, to refuse a Distributor's request to quote a price other than the ASSA ABLOY ACCENTRA™ standard list price and regardless of whether ASSA ABLOY ACCENTRA™ or its sales representatives have previously quoted discounted prices to the Distributor on some or all of its purchase orders.

NON-CATALOGED PRODUCTS

Products not cataloged or listed in this price book will be considered as special products, and will not be manufactured without prior written approval from ASSA ABLOY ACCENTRA™.

A minimum special handling charge of \$50.00 will be added for non-cataloged product. Any additional labor or material required will be charged accordingly. If products have already been made and/or are located in the shipping room, the 45% reprocessing fee will apply.

Special products require special handling, and therefore standard lead times may not apply. Please consult with your ASSA ABLOY ACCENTRA™ Sales Representative for further details.

CHANGES/CANCELLATION OF ORDERS

Changes or cancellations to an order will result in a charge of costs for material and labor expenses that have been incurred prior to notification from Customer. Handling charges are billed on Customer's original order. If products have already been made and/or are located in the shipping room, the 45% change/cancellation fee will apply.

All Non-Cataloged Goods may not be changed or cancelled. All change requests for goods, other than for the reasons stated above, must be submitted in writing to Customer Service within two (2) business days of receipt of acknowledgment of the order.

TERMS & CONDITIONS

FLASH

- Orders received prior to 1pm EST will ship within 24 hours
- Electrified products - Maximum 50 locks per order
- Orders cannot be changed or cancelled due to the promptness of delivery

QUICK SHIP

- Orders received prior to 4:30 EST will ship within 5 working days
- Standard Buying Program discount applies
- Orders can be changed or cancelled within 24 hrs of receipt unless the product is already in the process of being made
- If the product has been made the 45% cancellation fee will apply
- Due to the promptness of delivery changes or cancellations cannot be made if request is received after 24 hrs of receipt of the order without incurring a 45% cancellation fee
- The cancellation charges are billed on the Customer's original order

PACKAGING

Many items are defined as to Case Lot Packaging or Minimum Order. The Case Lot policy does not apply to hardware to be used on a specific hardware project.

DELIVERY

Orders will be acknowledged and given a scheduled delivery date based on estimated manufacturing lead times. Complete information is required to process all orders. Orders with insufficient information for processing (i.e. door sizes, handing, etc.) may be subject to extended lead times which are relative to the time required in obtaining the necessary information for order processing. Manufacturing lead time will begin once all information is received to process an order. ASSA ABLOY ACCENTRA™ will use reasonable efforts to deliver products as estimated, but makes no guarantees as to delivery dates.

ASSA ABLOY ACCENTRA™ will not be liable for back charges incurred based on availability of product or as a result of delays in delivery caused by insufficient information required to process an order. ASSA ABLOY ACCENTRA™ will not be held responsible for delays in delivery caused by strikes, fires, floods or any other causes beyond our control, including the delivery of material to us. Under no circumstances shall ASSA ABLOY ACCENTRA™ be liable or accountable for consequential damages due to failure of delivery.

CLAIMS

In the event of Company or Customer error, claims for shortages, pricing errors and/or incorrectly filled orders must be submitted in writing to Customer Service within thirty (30) days from receipt of material.

Any claims for shortages or damage by the Carrier must be made by the Customer directly to the Carrier.

INVOICE DEDUCTION

A ASSA ABLOY ACCENTRA™ Sales Representative or Customer Service Representative must be notified of any disputed invoices within sixty (60) days from the date of invoice. Deductions should only be taken for the disputed amount and the balance of the invoice is due and payable within standard payment terms.

RETURNED GOODS

It is the policy of ASSA ABLOY ACCENTRA™ to not accept returns of any materials that are correctly furnished as per the Distributor's Purchase Order. Return of product due to customer order error or accommodation must be pre-arranged with ASSA ABLOY ACCENTRA™ and approved in writing by ASSA ABLOY ACCENTRA™ Sales Management.

No Returns accepted for the following: Specials, Anything Used, Discounted, Modified or Damaged Product, Electrical Products, Incomplete Products (e.g. missing keys, levers, roses, etc) or 10B Finished products.

All products returned as "Goodwill" must meet the following criteria to be considered a return:

- Be in original, unmarked and undamaged cartons.
- Be valued in excess of \$250.00 net.
- Shipped and invoiced within the previous 120 days.
- Can't be custom, non-cataloged goods, master-keyed or ASSA ABLOY ACCENTRA™ Quick Ship Product or 10B Finished products.

A MINIMUM reprocessing fee of 45% will be charged. Upon receipt and verification by ASSA ABLOY ACCENTRA™ that the returned merchandise meets the foregoing conditions, a credit will be issued for the original invoice amount less the MINIMUM 45% reprocessing fee.

"Goodwill" products that meet the foregoing criteria may be returned by fulfilling the following conditions:

- Send an RGA request in writing to the ASSA ABLOY ACCENTRA™ Sales Representative serving the Purchaser's area.
- Ensure the RGA labels that are sent to Purchaser by ASSA ABLOY ACCENTRA™ are visible on return goods shipment.

- Ensure that the RGA number appears on the return shipment label and is legible.
- Return the authorized merchandise within sixty (60) days from the date of RGA issuance date.
- Return shipments must be freight prepaid to the location specified on the RGA. ASSA ABLOY ACCENTRA™ is not liable for damages to product during shipping.

No credit may be taken or issued prior to RGA approval and receipt of product.

All defective goods within the terms of our limited warranty may be returned for credit or replacement.

TAXES

Prices do not include any present or future Federal, State, or Local property, license, privilege, sales, use, excise, gross receipts or other like taxes or assessments, which may result from transactions or any services performed in connection herewith.

GOVERNING LAW

The rights and obligations of the parties shall be governed by the laws of the State of North Carolina, excluding any conflicts of law provisions. The United Nations Convention on Contracts for the International Sale of Goods shall not apply to this Agreement.

LIMITED WARRANTY

The Terms and Conditions outlined above are subject to the ASSA ABLOY ACCENTRA™ Limited Warranty, which is included in this Price List and incorporated herein by reference.

PRODUCT MODIFICATIONS

ASSA ABLOY ACCENTRA™ products are not designed or intended for aftermarket modification. The warranty on ASSA ABLOY ACCENTRA™ products becomes void if the product is modified in any way, regardless of whether the modification causes or contributes to any alleged defect. Warranty voiding modifications include, but are not limited to, third-party electrification of non-electric products and/or the installation of non-approved or non-ASSA ABLOY ACCENTRA™ components.

If a ASSA ABLOY ACCENTRA™ product is modified it no longer meets industry certification and quality control standards applicable to the original product and is no longer a genuine ASSA ABLOY ACCENTRA™ product. A modified product may not be sold as a ASSA ABLOY ACCENTRA™ product and no ASSA ABLOY ACCENTRA™ trademarks or certification marks based on the original ASSA ABLOY ACCENTRA™ product, such as U.L. or ANSI/BHMA marks, may appear anywhere on the modified product or on any packaging, literature, or instructions sold with the modified product.

All original ASSA ABLOY ACCENTRA™ branded packaging and literature carries ASSA ABLOY ACCENTRA™ trademarks and must be destroyed if the original ASSA ABLOY ACCENTRA™ product is modified. Portions of the product that carry a ASSA ABLOY ACCENTRA™ trademark or certification mark must be discarded and/or replaced by the party making the modification. U.L. and other certification testing and marking are also the responsibility of the party making modification. The use of ASSA ABLOY ACCENTRA™ trademarks on modified products constitutes trademark infringement.

CYLINDERS FOR COMPETITOR PRODUCTS

ASSA ABLOY ACCENTRA™ cylinders or cores for use in non-ASSA ABLOY ACCENTRA™ manufactured locking devices for which ASSA ABLOY ACCENTRA™ has an equivalent, will be assessed a Cylinder Service Fee of \$100.00 (net) per Cylinder. This fee applies to master keyed cylinder only orders, 1 bitted high security cylinders and zero or 1 bitted restricted cylinder orders.

DELAYED ORDER NOTIFICATIONS (DON'S)

The orders awaiting a response for a DON will be cancelled if no answer is received from the customer after 5 Days.

FIRE RATED OPENINGS

Any retrofit or other field modification to a fire rated opening can potentially impact the fire rating of the opening, and ACCENTRA makes no representations or warranties concerning what such impact may be in any specific situation. When retrofitting any portion of an existing fire rated opening, or specifying and installing a new fire-rated opening, please consult with a code specialist or local code official (Authority Having Jurisdiction) to ensure compliance with all applicable codes and ratings.

TRADEMARK USE POLICY: ASSA ABLOY AMERICAS

The following policy (“Policy”) of ASSA ABLOY Americas (“ASSA ABLOY”), and all of its affiliated group companies (collectively, the “Group Companies”), applies to the use of certain intellectual property of all such Group Companies, including all trademarks, names, logos, product images, and related information (the “ASSA ABLOY Marks”). ASSA ABLOY Marks are proprietary and critical to the success of ASSA ABLOY and the Group Companies, and may only be used in strict compliance with this Policy.

This Policy covers any person or entity reselling any product of any Group Company with the consent of such Group Company (each, an “Approved Reseller”). Each Approved Reseller has a non-exclusive right to use certain of the ASSA ABLOY Marks relating to any of the Group Companies for which it is an Approved Reseller, subject to the following conditions:

- (1) Approved Reseller’s use of ASSA ABLOY Marks must be truthful, fair, and not misleading;
- (2) Approved Reseller’s advertising must clearly indicate that it is advertising of the Approved Reseller, and is not advertising of ASSA ABLOY;
- (3) Approved Reseller may not use any ASSA ABLOY Marks as part of or in connection with a domain name;
- (4) Approved Reseller’s advertising must not imply or suggest an association between the Approved Reseller and ASSA ABLOY other than that of buyer and seller;
- (5) Approved Reseller’s use of ASSA ABLOY Marks must be a positive representation of ASSA ABLOY, the Group Companies, and their products;
- (6) Approved Reseller’s trade name must be more predominant on Approved Reseller’s advertising than the ASSA ABLOY Marks;
- (7) Approved Reseller’s use of ASSA ABLOY Marks must include the trademark symbol ® or TM, as appropriate, along with the following trademark legend printed in legible text on the Web page or document containing ASSA ABLOY Marks: “[describe ASSA ABLOY Marks] are trademarks or registered trademarks of ASSA ABLOY, Inc. or one of its affiliates in the United States and other countries.”;
- (8) Approved Reseller must not make modifications of any ASSA ABLOY Marks; and
- (9) Approved Reseller may use only ASSA ABLOY Marks associated with the Group Companies for which it is an Approved Reseller (e.g., an Approved Reseller that sells Group Company X products but not Group Company Y products may use Group Company X trademarks in connection with its sale of Group Company X products, but may not use Group Company Y trademarks).

ASSA ABLOY reserves the right to review Approved Reseller’s usage of ASSA ABLOY Marks at any time and may:

- (a) require changes to the use of ASSA ABLOY Marks at any time in its sole discretion, which changes must be implemented within 30 days of written notice to Approved Reseller;
- (b) condition the use of ASSA ABLOY Marks on ASSA ABLOY’s prior approval of such use, which approval may be withheld in its sole discretion;
- (c) revoke permission to use ASSA ABLOY Marks at any time for any or no reason upon 30 days prior written notice to Approved Reseller; and
- (d) revoke permission to use ASSA ABLOY Marks immediately upon notice to Approved Reseller in the event Approved Reseller is in violation of this Policy, or of any other agreement with ASSA ABLOY or any Group Company.

Approved Reseller’s right to use ASSA ABLOY Marks in no way conveys to Approved Reseller any proprietary or economic interest in any ASSA ABLOY Marks.

Use of ASSA ABLOY Marks in violation of this Policy may result in severe civil and criminal liabilities. ASSA ABLOY will vigorously enforce this Policy by seeking all appropriate legal remedies, including, but not limited to, pecuniary damages and injunctive relief.

TECHNICAL INFORMATION AND ADVICE

(a) All designs, data, and specifications provided by Company are proprietary and will not be disclosed or reused by Customer without the prior written consent of Company; (b) Company assumes no obligation or liability for any advice given by Company, the results obtained, or damages incurred, and all such advice is given and accepted at Customer’s risk.

For Terms & Conditions and Warranty information pertaining to product sales in Canada, please visit www.assaabloy.ca/terms.

EXPORT CONTROL AND SANCTIONS

The Customer represents and warrants to ASSA ABLOY ACCENTRA™ that it will always act in compliance with Economic Sanctions and Export Control Laws, and that:

- a) neither the Customer, its affiliates, or any of their respective directors, officers, employees nor, so far as the Customer is aware, any agents or other persons acting on behalf of any of the foregoing:
 - i) is, or has been, a Listed Person;
 - ii) has engaged in any business dealings or activities that would reasonably be expected to result in it becoming a Listed Person;
 - iii) directly or indirectly, has conducted or is conducting any business dealings or activities with or for the benefit of, or is otherwise involved in any business with a Listed Person, or otherwise acting in violation of Economic Sanctions and Export Control Laws;
 - iv) has engaged or is engaging in any transaction that circumvents, evades or avoids, or has the purpose or effect of circumvention, evading or avoiding, or attempts to violate, any Economic Sanctions and Export Control Laws; or
 - v) is, or has been, in violation of, or subject to, any investigation or enquiry by, or on behalf of, any governmental or other regulatory body relating to Economic Sanctions and Export Control Laws.
- b) the Customer shall act in compliance with Economic Sanctions and Export Control Laws, and shall not sell nor re-export the Product without all requisite licenses and approvals under Economic Sanctions and Export Control Laws;
- c) the Customer shall not sell, export or re-export, the Product, directly or indirectly, to the Russian Federation or Belarus or for use in the Russian Federation or Belarus (whether or not permitted under Economic Sanctions and Export Control Laws applicable to the Customer);
- d) the Customer shall undertake its best efforts to ensure that the purpose of this Clause is not frustrated by any third parties further down the commercial chain, including by possible resellers;
- e) the Customer agrees to (i) cascade the contractual obligations set forth in this Clause. in contracts with third parties, including possible resellers, further down the commercial chain.; and (ii) set up and maintain an adequate monitoring mechanism to detect conduct by any third parties further down the commercial chain, including by possible resellers, that would frustrate the purpose of this Clause.;
- f) the representations and warranties set forth in this Clause shall always remain true and correct;
- g) the Customer will provide written notice to ASSA ABLOY ACCENTRA™ as promptly as possible and in any event within five business days, if (i) any representation or warranty should cease to be true at any time., or (ii) the Customer should encounter any problems in applying Clauses b)- e), above, including any relevant activities by third parties that could frustrate the purpose of said clause; and
- h) the Customer will not engage in any transaction for Military End-Use unless explicitly approved by ASSA ABLOY ACCENTRA™.
- i) The Customer will provide all information relating to requests for Products, that the Customer suspects could violate or circumvent Economic Sanctions and Export Control Laws, including requests from or on behalf of a Listed Person, and other attempts to acquire ASSA ABLOY ACCENTRA products in violation of Economic Sanctions and Export Control Laws. The Customer will, to the best of its abilities, cooperate with ASSA ABLOY ACCENTRA™ to facilitate compliance with Economic Sanctions and Export Control Laws and will upon ASSA ABLOY ACCENTRA™'s request provide ASSA ABLOY ACCENTRA™ with true, complete and correct copies of all documentation relating to any business dealings involving the Product, including but not limited to, end-user certifications, information concerning compliance with the obligations under Clause. b)- e), and other information as may be required by ASSA ABLOY within two weeks of the simple request of such information.

ASSA ABLOY ACCENTRA™ shall not be obliged to make any payment or take any other action if ASSA ABLOY ACCENTRA™ believes in good faith that such action may constitute a violation, contribute to a violation, or constitute a circumvention of any Economic Sanctions and Export Control Laws.

COMPLIANCE WITH ANTI-TRUST, ANTI-CORRUPTION AND DATA PRIVACY LAWS

The Customer , its directors, officers, and employees shall perform their obligations under these Terms and Conditions in full compliance with the ASSA ABLOY Code of Conduct which is accessible online at:

CoC Business partner 2019 English.pdf



LIMITED WARRANTY

ASSA ABLOY ACCENTRA™ (the “Company”) warrants that its products sold under the ACCENTRA trade name in the United States of America & Canada are free from defects in work-manship and materials under normal use and service.

This warranty does not cover defects or damage arising from improper installation, lack of or improper maintenance, improper storage, shipping and handling, corrosion, erosion, ordinary wear and tear, misuse, abuse, accident, unauthorized service, or use with unauthorized non-ACCENTRA products or parts. This warranty is void if any modification

is made to the product, regardless of whether the modification causes or contributes to the alleged defect. All modifications are made at the risk of the party making the modification.

The only liability of the Company in tort or contract whether under this warranty or otherwise shall be limited to the repair or replacement of any product or component part which shall prove defective as covered by this warranty, within the stated time frame listed below, after delivery to the original purchaser.

Locks

8800 series mortise locks	10 years
8800 electrified series mortise locks	2 years
5400CK series cylindrical knob locks	10 years
5400LN series cylindrical lever locks	7 years
5400LN electrified series cylindrical lever locks	2 years
5300LN series cylindrical lever locks	5 years
5300LN electrified series cylindrical lever locks	1 year
4600YC series cylindrical knob locks	3 years
4600LN series cylindrical lever locks	3 years
4700LN series cylindrical lever locks	5 years
4700LN electrified series cylindrical lever locks	1 year
6400LN series monolock/retrofit (Discontinued May 2024)	7 years
nexTouch® NTB, NTM, NTT, NTD, NTC	3 years
Competitor Indicator Kits	2 years
All other locksets	1 year

Other

ACCENTRA KeyMark® keys	Lifetime
All other ACCENTRA products	1 year

Exit Devices and Trims

1500 series exit devices	1 year
1800 series exit devices	3 years
2100 series exit devices	3 years
6000 series exit devices	10 years
7000 series exit devices	5 years
Electrified exit devices	2 years
600F series exit device trims	5 years
580F and 540F series exit device trims	3 years
690F and 691F exit device trims	2 years
440F series exit device trims	2 years
All other exit device and trim products	1 year

Door Controls

4400, 3000 and 51 series closers	30 years
1100, YDC200 series closers	5 years
5800, 2700 and 1900 series closers	10 years
All other door controls	10 years

Finishes

PVD (Discontinued January 2012)	Lifetime
All other finishes	1 year

Electromechanical:

All components of electromagnetic products are covered by a limited warranty period of one year after invoice date thereof of the original purchaser from us.

Keying Systems:

All bittings shall be originated or authorized by the ACCENTRA Key Systems Department to be compatible with one another in a specific type of cylinder (conventional, patented, security, high security, interchangeable core) and within a particular keying system.

Warranty for Cylinders Factory or Field Combined:

Cylinders shall be periodically lubricated depending on environmental conditions. Dry graphite, molybdenum disulfide or Polyube™ are recommended. Petroleum based liquid lubricants should only be used in cylinders in harsh or corrosive environments and should not be mixed with dry lubricants. Cylinder and/or core warranty will be voided if used in non-ACCENTRA locking devices.

Warranty for Cylinders Field Combined:

- Keys shall be cut to the ACCENTRA key bitting specifications required for the particular keyway and depth system.
- All pin lengths shall be selected according to prevailing factory standards.
- Original ACCENTRA cylinders and cylinder components, including pin tumblers and key blanks, shall be used. We reserve the right to void the warranty if we deem that a malfunction is a result of non-original components which do not conform to ACCENTRA standards.

General Procedure

Product repair or replacement, or associated charges, will not be accepted under this warranty unless prior authorization from ACCENTRA has been given. Upon receipt of products returned for repair or replacement, we will determine whether products qualify for repair or replacement under this warranty. If they do not, we will obtain authorization prior to proceeding. We have no liability to pay any costs of repair performed by anyone other than qualified personnel authorized by ACCENTRA prior to the work being done.

The Company will not pay for the cost of repair performed other than in accordance with this warranty. Written notice of a product or component part believed to be defective as covered by this warranty should be sent to ASSA ABLOY ACCENTRA™, 225 Episcopal Road, Berlin, Connecticut 06037-4004, and should include your name and address, an identification of the product or component part and a brief description of the defect. Upon receipt of such notice, the Company will inform you where to ship such product or component part, shipping charges prepaid for examination and, in the event such examination reveals a defect covered by this warranty, the product will be repaired or replaced. The Company reserves the right to replace discontinued product with an equivalent product as deemed by the Company.

THIS WARRANTY IS IN LIEU OF ALL OTHER EXPRESS WARRANTIES. TO THE EXTENT PERMITTED BY LAW, ALL IMPLIED WARRANTIES ARE LIMITED TO THE DURATION OF THIS WARRANTY. ASSA ABLOY ACCENTRA™ SHALL NOT BE LIABLE FOR ANY INCIDENTAL OR CONSEQUENTIAL DAMAGES. SOME STATES DO NOT ALLOW LIMITATIONS ON HOW LONG AN IMPLIED WARRANTY LASTS OR THE EXCLUSION OR LIMITATION OF INCIDENTAL OR CONSEQUENTIAL DAMAGES, SO THE ABOVE LIMITATION OR EXCLUSIONS MAY NOT APPLY TO YOU. THIS WARRANTY GIVES YOU SPECIFIC LEGAL RIGHTS, AND YOU MAY ALSO HAVE OTHER RIGHTS WHICH VARY FROM STATE TO STATE.

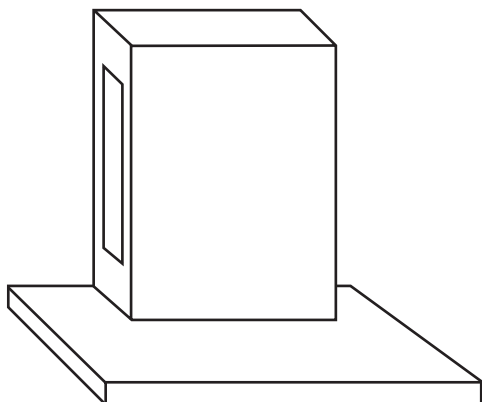

#202 10" WIDE MORTISE LEVER HANDLE
Oak Finish
13-0202-9002-999

LIST PRICE	
Mount Only	\$221.00

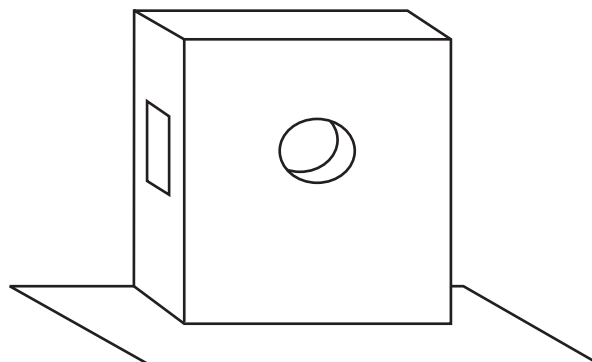

#112 CYLINDRICAL FOR 5400LN/5300LN
2-3/4" or 2-3/8" Backset
Oak Finish
13-5400-0001-999

LIST PRICE	
Mount Only	\$125.00

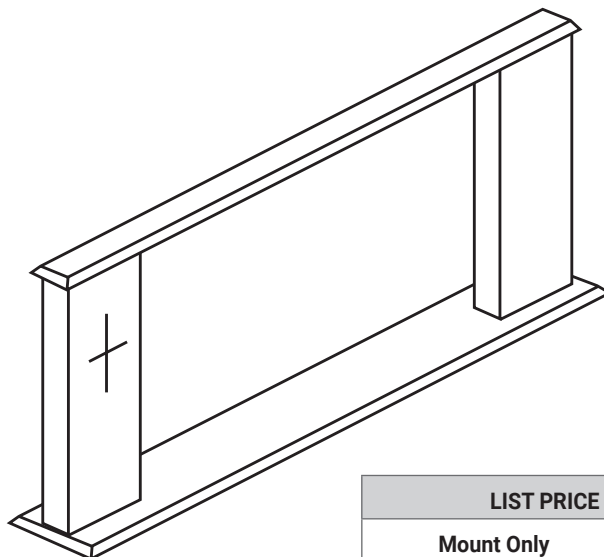

LIST PRICE	
Mount Only	\$399.00

PART NUMBER	MODEL NUMBER	FOR DEVICE
60-7000-9380-999	380*	7100 X Exit Only
60-7000-9381-999	381*	7100 X 626F
60-7000-9382-999	382*	7100 X 633F
60-7000-9383-999	383	7130 X Exit Only
60-7000-9384-999	384	7130 X 656F
60-7000-9385-999	385	7130 X 673F
60-7000-9386-999	386*	7110 X Exit Only
60-7000-9387-999	387*	7110 X 626F
60-7000-9388-999	388*	7110 X 633F

*Can also be used for 6000, 2100 or 1800 series devices.

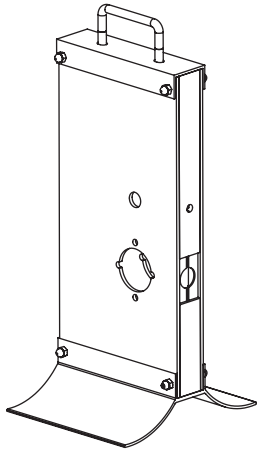

nexTouch®
Cylindrical for NTB600 Series
Plexi/Steel
022234

LIST PRICE	
Mount Only	\$478.00

FINISH SAMPLES

PART NUMBER	LIST PRICE
009992	\$362.00

KEY SYSTEMS SECURITY POLICY

The purpose of this security policy is to enforce our policies concerning high security, security and protected keyway product, as well as master key system information. The purpose for the establishment of any security system is to provide an increased level of protection for the Facility owner.

No master key system information or security related product is to be given or sold to anyone other than the Facility owner through written correspondence. Verification must be submitted (fax copy will be acceptable) to Key Systems Administration. The verification must be on the Facility's letterhead and signed by a Facility authorized systems administrator. Key Systems Administration does not maintain "Letters of Authorization" on file. Each order must be accompanied by proper authorization.

Only after the authorization has been verified will the order be processed for production.

This security policy refers to the following:

- Bitting information (even one bitting, absolutely no top-level master keys)
- Bitting lists (all formats; i.e., hard copy, disc)
- High Security systems
- Security cylinder systems

No orders are to be processed through Key Systems Administration without proper authorization.

Only orders with appropriate authorization attached will be given priority.

Requests for Systems information without proper authorization from the owner will be denied.

Requests for information regarding the purchase of any systems support products as listed above will be referred to the local authorized sales agency.

KEY SYSTEMS ADMINISTRATION

CUSTOMER BITTINGS AND SAMPLE KEYS: (MASTER KEYING OR CMK CHARGES NOT INCLUDED)

PRODUCT DESCRIPTION		LIST PRICE
Customer Bittings and Sample Keys	ADD	\$16.00

NOTE: All cylinders requested to be keyed to combinations not supplied by ACCENTRA will be subject to this charge. ACCENTRA releases all liabilities to systems generated by customer-supplied bittings and/or sample keys that are supplied by others. Purchase orders with customer-supplied bittings or sample keys not meeting ACCENTRA's specifications will be processed "0" bitted in the specified keyway.

CROSS KEYING: (NO CHARGE)

Disclaimer: ACCENTRA reserves the right to release total liability of any factory-generated master key system which incorporates cross keying, both controlled and uncontrolled. A master key system incorporating cross keying yields less security and jeopardizes system expansion.

Controlled Cross Keying: A condition in which two or more different keys of the same level of keying and under the same higher level key(s) operate one cylinder by design; e.g., XAA1 operated by AA2.

Uncontrolled Cross Keying: A condition in which two or more different keys under different higher level keys operate one cylinder by design; e.g., XAA1 operated by AB, AB1.

HOTEL LOCKS/CYLINDERS

When ordering a factory-keyed system that includes hotel function locks that are to be operated by the GMK, MK and change keys, all cylinders in the system have to be 7-Pin length with 7-Pin keys.

BITTING

To protect the security of keying systems, bitting lists will only be sent to the end user or his designated agent, via Certified Mail Return Receipt Requested or UPS AOD. Copies will not be transmitted via fax. The complete name and address where the bitting list is to be sent must be indicated on the letter of authorization and on the purchase order.

# Bittings	Paper	Disc	Simple K	Key Wizard	Paper Price	Disc Price	Simple K/ Key Wizard Price
1-50	KC1-YL	KCD1-YL	DLSK1-YL	DLKW1-YL	\$469.00	\$307.00	\$388.00
51-200	KC2-YL	KCD2-YL	DLSK2-YL	DLKW2-YL	\$631.00	\$469.00	\$550.00
201-1000	KC3-YL	KCD3-YL	DLSK3-YL	DLKW3-YL	\$791.00	\$629.00	\$710.00
1001-3000	KC4-YL	KCD4-YL	DLSK4-YL	DLKW4-YL	\$955.00	\$792.00	\$874.00
3001-6000	KC5-YL	KCD5-YL	DLSK5-YL	DLKW5-YL	\$1,082.00	\$919.00	\$1,000.00
6001-9000	KC6-YL	KCD6-YL	DLSK6-YL	DLKW6-YL	\$1,540.00	\$1,378.00	\$1,459.00
Over 9000	KC7-YL	KCD7-YL	DLSK7-YL	DLKW7-YL	Consult Factory		

*Lead times may vary; consult Key Systems Administration

NOTE: Bitting Lists requested for keysets ordered with factory keyed product for either a new or existing system will be provided at no charge, except for SimpleK DLSK1 thru DLSK7 & Key Wizard DLKW1 thru DLKW7. For existing system, pricing above will apply, for new system, see Key Management section below.

- Additional Bittings or P.O.'s for Bitting Lists Only – **EXISTING MASTER KEY GROUPS**
Up to 10 **total** for keysets tied to **existing** master key groups will be provided at no charge 11 or more bittings will be charged per above chart
- Additional Bittings or P.O.'s for Bitting Lists Only – **NEW MASTER KEY GROUPS**
Regardless of the quantity being requested, will be charged per above chart

These prices are for a hierarchial Master Key system with no cross-keying of selected keys. For special requirements or for systems prior to 1999, consult Key Systems Administration for a quote.

ACCENTRA releases all liabilities for cylinders not pinned to factory master key systems.

ACCENTRA is not liable for cylinders pinned incorrectly in the field.

KEY MANAGEMENT

SimpleK: Special online ordering procedures accessible via the ASSA ABLOY Door Security Solutions Extranet (www.assaabloydss.com) – contact customer service for more information.

SimpleK – Standard Edition		
Catalog #	Description	Price
SMK040-30	Primary License (3 users)	\$3,286.00
SMK040-31	Updates & Support Plan on Primary License, 1 year	\$615.00

SimpleK – Professional Edition		
Catalog #	Description	Price
SMK042-30	Primary License (3 users)	\$4,383.00
SMK042-32	Additional license	\$579.00
SMK042-35	Updates & Support Plan on Primary License, 1 year	\$956.00
SMK042-33	Updates & Support Plan on Additional License, 1 year (per Add. Lic.)	\$159.00

Add-On Modules		
Catalog #	Description	Price
SMK032-31	Item Tracking	\$1,387.00
SMK032-33	Web Interface	\$1,827.00
SMK032-35	Room Management	\$877.00
SMK032-37	Mobile Applications	\$1,242.00

KEYING CHARGES AND KEYS

KEYING CHARGES:

PRODUCT DESCRIPTION		LIST PRICE
Masterkeying, Grand Masterkeying, Great Grand Masterkeying (all cylinders except security cylinders and IC cores)	ADD	\$16.00
MK, GMK, GGMK for 5000, U5000 Series Security Cylinders	ADD	\$0.00
MK, GMK, GGMK for 1210, 1220, 1210H, or A600 IC Cores	ADD	\$0.00
Cylinder or Lock Operated by Two or More Keys Not MK or GMK	ADD	\$16.00
Customer Bittings and Sample Keys	ADD	\$16.00
Construction Masterkeying suffix CMK or CGMK (in addition to masterkeying charges) NOTE: Not available with 5000, U5000 Series Security Cylinders.	ADD	\$16.00
7-Pin Cylinders, Locksets, Deadlocks (add to each cylinder)	ADD	\$2.00

KEYS:

PRODUCT DESCRIPTION	LIST PRICE
<u>MASTER KEYS, CONSTRUCTION MASTER KEYS, CONTROL KEYS:</u>	
Standard Bow All Keys (except Security Keys) Add Change Break Out Key	\$15.40
"A" or "F" Bow All Keys (except Security Keys) Add Change Break Out Key	\$15.70
Security Keys (see page 39)	\$19.40
Extra Standard Bow Change Keys ordered with cylinder/lockset Change Keys/Cut Keys ordered separately priced on page 29	\$5.10
Extra "A" or "F" Bow Change Keys ordered with cylinder/lockset Change Keys/Cut Keys ordered separately priced on page 29	\$5.40
For keys packed separately (Indicate appropriate "ship to" address on keying cover sheet) per cylinder charge	\$4.20

NOTE: Two cut change keys are standard per lockset/cylinder. Keyblanks cannot be substituted for cut keys. Cylinders pinned directly to GMK or MK level keys do not include two cut keys. MK and GMK keys are ordered as a separate item.

STAMPING CHARGES

STAMPING:

Description	List Price
Stamping letters or numbers on cylinder or padlock body (PDSTMP)	\$4.00
Stamping letters or numbers on keybows in lieu of keyset symbols or bittings (max. 8 characters)	No Charge
Stamping letters or numbers on keybows in addition to keyset symbols or bittings (max. 8 characters) (per key) (VASK)	\$4.00
Stamping letters or numbers on keyblanks (max. 8 characters) (per key) (VASK)	
Special stamping on keybows - "Do Not Duplicate", "US Property - Do Not Duplicate"	No Charge
Special stamping on keybows with custom or existing die stamp (per key)	\$4.00
New custom die stamp - one time charge	\$1,125.00

VISUAL CYLINDER/KEY CONTROL:

Description	Cylinders		Keys	
	Stamping	List Price	Stamping	List Price
VKC0 - No stamping except keyway designation (keys will be tagged)	No Stamping	No Charge	No Stamping	\$5.00/key
VKC1 - Keys only	N/A	No Charge	Keyset	No Charge
VKC2 - Cylinder and keys*	Keyset	\$4.00/cyl	Keyset	No Charge
VKC3 - Cylinder*	Keyset	\$4.00/cyl	Bittings	No Charge
All VKC, VDC or VAC stamping codes that using alternate symbol	Alternate Stamping	\$4.00/cyl	Alternate Stamping	\$4.00/key

CONCEALED CYLINDER/VISUAL KEY CONTROL:

Description	Cylinders		Keys	
	Stamping	List Price	Stamping	List Price
CKC2 - Cylinder and keys*	Keyset	\$4.00/cyl	Keyset	No Charge
CKC3 - Cylinders only*	Keyset	\$4.00/cyl	Bittings	No Charge
All CKC, CDC or CAC stamping codes that using alternate symbol	Alternate Stamping	\$4.00/cyl	Alternate Stamping	\$4.00/key

*Cylinder face stamping not available for ACCENTRA KeyMark®, security, and high security products

NOTE: See page 7 for code definitions and examples

KEYS

LEGEND:

STOCK SECTION: Includes PARA/EIR

SINGLE SECTION: Includes G, S, T Single Series Sections. (GA, GB, GC, GD, GF, GG, GH, SA, SB, SC, SD, SE, SF, SG, SH, TA, TB, TC, TD, TE, TF, TG, TH)

MULTIPLY SECTIONS: Includes any combination of G, S, T Series Sections. (GST, GMK, GAH, GBG, GCE, GDF, SMK, SAH, SBG, SCE, SDF, TMK, TAH, TBG, TCE, TDF)

RESTRICTED SECTIONS: Includes K, L, P, V, Y, Z Series Sections.

KEY BLANKS:

.51 PIN TUMBLER

Model #	Old List Number	Stock Section	Single Section	Multiplex Sections	Restricted Sections
RN8	8 N.S.	\$3.00	\$3.00	\$7.28	\$7.78
RN11	11 N.S.				
RN117 (7 Pin)	117	\$5.20	\$6.98		
RN411	411F				
FN411	--	\$5.50	\$7.28	\$7.58	\$8.08
FN411S	411FS				

NOTE: All standard key blanks in the above section are sold in multiples of 50 pieces only.

CUT KEYS:

Model #	Old List Number	Stock Section	Single Section	Multiplex Sections	Restricted Sections
RN8	8 N.S.	\$16.70	\$16.70	\$17.20	\$17.60
RN11	11 N.S.				
RN117 (7 Pin)	117	\$16.70	\$17.20		
RN411	411F				
FN411	--	\$17.00	\$17.50	\$17.50	\$17.90
FN411S	411FS				
Note:	For "A" or "F" Bows per key			ADD	\$0.30

NOTE: Security systems typically use the "A" key bow, although conventional systems blanks. All orders for security key blanks must be specific and reference the master key systems registry numbers, if existing. All orders for security key blanks must also be accompanied by proper authorization. See page 39 for security key blank prices.

CONTROL KEY BLANKS

Model #	Product Description	List Price
FN117C	For 1210 Core "0" Bitted 6-Pin with #1 7th cut	\$13.44
FN118C	For 1220, 1210H Cores "0" Bitted 7-Pin with #1 8th cut	

NOTE: Bows of control key blanks are stamped "CONTROL."

COMPETITOR KEYWAYS

KEYWAYS AVAILABLE: Best® = A, B, C, D, E, F, G, H, J, K, L and M
Schlage® = C

Model #	Product Description	List Price
BN67	6/7-Pin Keyblanks for Best®. Specify Keyway.	\$3.18
SC11	6-Pin Keyblanks for Schlage®. Specify Keyway.	\$3.18

.51 PIN TUMBLER

MODEL #	OLD LIST NUMBER	STOCK SECTION	SINGLE SECTION	MULTIPLEX SECTIONS
RN9	9, 9 1/2-109, 109 1/2 N.S.	\$3.30	\$3.60	\$5.42

EMERGENCY KEYS

MODEL #	STOCK SECTION
E503 (used for cylindrical locks)	\$4.10
E203 (used for mortise locks)	
E502 (used for D291/D292 deadbolts)	

CONSTRUCTION CORE PROGRAMS

CONSTRUCTION CORES:

PROGRAM A: LARGE FORMAT INTERCHANGEABLE CORES

ALL locksets and cylinders ordered with large format interchangeable temporary cores will be provided with keyed alike standard 1210 or 1220 temporary cores.

PRODUCT DESCRIPTION		606 FINISH
1210 6-Pin Temporary Core	ADD	\$86.00
1220 7-Pin Temporary Core	ADD	\$88.00

When ordering locksets to be used with ACCENTRA KeyMark® permanent cores, use the following cylinder designations (no full cylinder deduct with the Added to Lock price):

TYPE	MODEL NUMBER*	ADDED TO LOCK	ORDERED SEPARATELY
Mortise x 6-Pin	K825 x CT6LL	\$86.00	\$194.00
Mortise x 7-Pin	K825 x CT7LL	\$88.00	\$196.00
Rim x 6-Pin	K845 x CT6LL	\$86.00	\$194.00
Rim x 7-Pin	K845 x CT7LL	\$88.00	\$196.00

*Note: These LFIC cylinders are not discounted with the product.

PROGRAM B: SMALL FORMAT INTERCHANGEABLE CORES

Option 1 - Disposable SFIC (K925)

All locksets and cylinders will be provided with disposable thumbturn type cores.

No keys are required. These cores are disposable and cannot be returned.

K925 disposable cores available in blue color only.

PRODUCT DESCRIPTION	ADDED TO LOCK	ORDERED SEPARATELY
Mortise/Rim - order K625/K645 x CT6SD for 6-Pin and CT7SD for 7-Pin	\$0.00	\$108.00
Mortise Tapered - order K635 x CT6SD for 6-Pin and CT7SD for 7-Pin		\$111.00
Cylindrical - order K925 x CT6SD for 6-Pin and CT7SD for 7-Pin		See Below

Option 2 - Lockable SFIC (K926)

All locksets and cylinders will be provided with keyed alike standard SFIC cores that are unrelated to the permanent master key system. Temporary operating and control keys are required; quantities must be specified. At the completion of the construction phase, these temporary cores may be returned.

PRODUCT DESCRIPTION	ADDED TO LOCK	ORDERED SEPARATELY
Mortise/Rim - order K625/K645 x CT6SL for 6-Pin or CT7SL for 7-Pin	\$44.00	\$152.00
Mortise Tapered - order K635 x CT6SL for 6-Pin or CT7SL for 7-Pin		\$155.00
Cylindrical - order K926 x CT6SL for 6-Pin or 7-Pin		See Below

PROGRAM C: SFIC PRODUCTS ORDERED SEPARATELY.

PRODUCT DESCRIPTION		LIST PRICE
K925 Disposable Cores (for 6- or 7-Pin) - order in multiples of ten	EACH	\$7.10
K926 (for 6- or 7-Pin) Lockable Cores - order in multiples of ten	EACH	\$44.00

CUT KEYS: Specify the required number of change keys and control keys on the order. Two control keys are provided at no charge. Two change keys are provided at no charge for the first 20 units ordered. One additional change key is provided for every 10 additional units at no charge. Additional keys will be invoiced at control key price.

PERMANENT CORES: Use a separate purchase order or line item to order the permanent cores. Permanent cores will be discounted the same as the product in which the core will be used if the order is marked with the correct number of cores for each product series, original factory order number, and the Competitive Price Quotation number. Product discounts do not apply to ACCENTRA KeyMark®

RETURN TEMP. CORES: Contact your Customer Service Representative for a Return Goods Authorization. Provide the factory order number and the year of the original order. Credit will be issued for all cores returned in good operating condition; credit is based on the net price after discount on the construction core at the time of the original order.

FIXED CORE COMPONENT/CYLINDRICAL LOCK & EXIT TRIM CYLINDERS:

MODEL #	NO. OF PINS	APPLICATIONS	606/626/BSP FINISHES
CONVENTIONAL KEYWAYS			
1801	6	Standard for 5300 [^] & 5400 [^] series knob locks and 540F series trim	\$94.00
1801A	7	Standard for 5400 [^] series knob locks and 540F series trim	\$96.00
1802	6	Standard for 5400LN, 6400LN [^] & inTouch ^{®^} series lever locks and 440F, 540F & 580F series trims Optional for 4700LN and 5300LN series lever locks	\$94.00
1802A	7	Standard for 5400LN & 6400LN [^] series lever locks and 540F & 580F series trims	\$96.00
1802L	6	Standard for 5300LN series locks used with 2"-2-1/4" thick doors	\$94.00
1802S	6	Standard for 5417LN & 6417LN function inside lever locks	
1805	6	Standard for 4600YC & 4700 [^] series knob locks	\$80.00
1806	6	Standard for 4600LN series lever locks	
1812	6	Standard for 4300 [^] , 4300LN [^] & 4800LN [^] series knob/lever locks	\$94.00
1803-54L	6	Standard for Corbin Russwin CL3100 (YC) & Sargent 11 Line (YC-) series lever locks. Optional for 4300LN [^] , 4600LN & 4800LN [^] series lever locks.	
1803A-54L	7	Standard for Corbin Russwin CL3100 (YC7), Sargent 11 Line (YC-7P-) series lever locks	\$96.00
1803-54K	6	Standard for 5400CK series knob locks and Heritage Collection lever locks	\$94.00
1803-53L	6	Standard for nexTouch [®] cylindrical series lever locks Optional for inTouch ^{®^} series lever locks	
1803-47L	6	Standard for 4700LN and 5300LN series lever locks Optional for 440F series exit device trim	
1803-46K	6	Optional for 4600YC series knob locks	
1803-46L	6	Standard for Corbin Russwin CLX3300 (YC) & SARGENT 10X Line (YC-) series cylindrical locks, mechanical functions, 1-3/8" - 2" doors.	
1803-46LL	6	Standard for Corbin Russwin CLX3300 (YC) & SARGENT 10X Line (YC-) series cylindrical locks, mechanical functions, 2-1/4" doors.	
1803A-46L	7	Standard for Corbin Russwin CLX3300 (YC7) & SARGENT 10X Line (YC-7P-) series cylindrical locks, mechanical functions, 1-3/8" - 2" doors.	\$96.00
1803A-46LL	7	Standard for Corbin Russwin CLX3300 (YC7) & SARGENT 10X Line (YC-7P-) series cylindrical locks, mechanical functions, 2-1/4" doors.	
1803-46E	6	Standard for Corbin Russwin CLX3300 (YC) & SARGENT 10X Line (YC-) series cylindrical locks, electrified functions, 1-3/8" - 2" doors.	\$94.00
1803-46LE	6	Standard for Corbin Russwin CLX3300 (YC) & SARGENT 10X Line (YC-) series cylindrical locks, electrified functions, 2-1/4" doors.	
1803A-46E	7	Standard for Corbin Russwin CLX3300 (YC7) & SARGENT 10X Line (YC-7P-) series cylindrical locks, electrified functions, 1-3/8" - 2" doors.	\$96.00
1803A-46LE	7	Standard for Corbin Russwin CLX3300 (YC7) & SARGENT 10X Line (YC-7P-) series cylindrical locks, electrified functions, 2-1/4" doors.	
OTHER MANUFACTURERS' KEYWAYS			606/626 FINISHES
2801	6	Schlage [®] "C" keyway for 5300 [^] & 5400 [^] series locks and 540F series trim	\$94.00
2802	6	Schlage [®] "C" keyway for 5300LN, 5400LN, 6400LN [^] & inTouch ^{®^} series lever locks and 440F, 540F & 580F series trims	
2805	6	Schlage [®] "C" keyway for 4600YC & 4700 [^] series knob locks	\$80.00
2806	6	Schlage [®] "C" keyway for 4600LN series lever locks	
2812	6	Schlage [®] "C" keyway for 4300 [^] , 4300LN [^] & 4800LN [^] series knob/lever locks	\$94.00
2803-54L	6	Optional for Corbin Russwin CL3100 (YC) & Sargent 11 Line (YC-) series lever locks. Optional for 4300LN [^] , 4600LN & 4800LN [^] series lever locks.	
2803-54K	6	Schlage [®] "C" keyway for 5400CK series knob locks and Heritage Collection lever locks	\$94.00
2803-53L	6	Schlage [®] "C" keyway for nexTouch [®] cylindrical series lever locks Optional for inTouch ^{®^} series lever locks	
2803-47L	6	Standard for 4700LN and 5300LN series lever locks Optional for 440F series exit device trim	
2803-46K	6	Optional for 4600YC series knob locks	
2803-46L	6	Optional for Corbin Russwin CLX3300 (YC) & SARGENT 10X Line (YC-) series cylindrical locks, mechanical functions. 1-3/8" - 2" doors.	
2803-46LL	6	Optional for Corbin Russwin CLX3300 (YC) & SARGENT 10X Line (YC-) series cylindrical locks, mechanical functions. 2-1/4" doors.	

Note: Cylinder plugs will be supplied in 606, 626, or BSP. Cylinder plugs with other manufacturers' keyways will be supplied in 606 or 626 only.

Schlage[®] C - Available Keyed Random or 0-Bitted

Other Manuf keyway - Available Keyed Random only, specify keyway Sargent LA, Schlage[®] E, Corbin Russwin L4, Corbin 60, Russwin D1

[^]Lockset series obsolete

FIXED CORE COMPONENT/CYLINDRICAL LOCK & EXIT TRIM CYLINDERS (CONT.):

MODEL #	NO. OF PINS	APPLICATIONS	606/626 FINISHES
OTHER MANUFACTURERS' KEYWAYS (CONT.)			
3804	6	Other manufacturer's keyway for 4700LN, 5300LN, 5400LN, 6400LN^ & inTouch®^ series lever locks and 440F, 540F & 580F series trims	\$118.00
3805	6	Other manufacturer's keyway for 4700^ series knob locks	
3806	6	Other manufacturer's keyway for 4600YC & 4600LN series knob/lever locks	\$104.00
3803-54L	6	Optional for Corbin Russwin CL3100 (YC) & Sargent 11 Line (YC-) series lever locks. Optional for 4300LN^, 4600LN & 4800LN^ series lever locks.	\$118.00
3803-54K	6	Other manufacturer's keyway for 5400CK series knob locks and Heritage Collection lever locks	
3803-53L	6	Other manufacturer's keyway for nexTouch® cylindrical series lever locks Optional for inTouch®^ series lever locks	
3803-47L	6	Standard for 4700LN and 5300LN series lever locks Optional for 440F series exit device trim	
3803-46K	6	Optional for 4600YC series knob locks	
3803-46L	6	Optional for Corbin Russwin CLX3300 (YC) & SARGENT 10X Line (YC-) series cylindrical locks, mechanical functions. 1-3/8" – 2" doors.	
100CV1	6	Arrow AR keyway for nexTouch® cylindrical series lever locks	\$94.00

FIXED CORE COMPONENT/DEADBOLT CYLINDERS:

MODEL #	NO. OF PINS	APPLICATIONS	606/626/BSP FINISHES
CONVENTIONAL KEYWAYS			
1807	6	Standard for D series deadbolts, single cylinder functions	\$80.00
1808	6	Standard for D series deadbolts, double cylinder functions	
1814	6	Standard for 4800LN^ series deadbolt	\$94.00
1803-134S	6	Standard for Heritage Collection Deadbolt used with interconnected lock (non-face removable) Optional for D Series deadbolts, single cylinder functions	
1803-134D	6	Optional for D Series deadbolts, double cylinder functions	
OTHER MANUFACTURERS' KEYWAYS			
2807	6	Schlage® "C" keyway for D series deadbolts, single cylinder functions	\$80.00
2808	6	Schlage® "C" keyway for D series deadbolts, double cylinder functions	
2814	6	Schlage® "C" keyway for 4800LN^ series deadbolt	\$94.00
2803-134S	6	Schlage® "C" keyway for Heritage Collection Deadbolt used with interconnected lock (non-face removable) Optional for D Series deadbolts, single cylinder functions	
2803-134D	6	Schlage® "C" keyway for D Series deadbolts, double cylinder functions	
3806	6	Other manufacturer's keyway for D series deadbolts	\$104.00
3803-134S	6	Other manufacturer's keyway for Heritage Collection Deadbolt used with interconnected lock (non-face removable) Optional for D Series deadbolts, single cylinder functions	\$118.00
3803-134D	6	Other manufacturer's keyway for D Series deadbolts, double cylinder functions	\$104.00

Schlage® C – Available Keyed Random or 0-Bitted

Other Manuf keyway – Available Keyed Random only, specify keyway Sargent LA, Schlage® E, Corbin Russwin L4, Corbin 60, Russwin D1

^Lockset series obsolete

Cylinder plugs will be supplied in 606, 626, or BSP. Cylinder plugs with other manufacturers' keyways will be supplied in 606 or 626 only.

NOTE: Cylinder rings/collars not furnished with locksets or other products when ordered less cylinders.
Cylinder rings/collars furnished at no charge when ordered with cylinders/housings.

FIXED CORE MORTISE CYLINDERS:

MODEL #	PRODUCT DESCRIPTION	LENGTHS	CAM	ALL FINISHES
1108	Dummy Mortise Cylinder	1" - 1-3/4"	N/A	\$76.00
1152	Standard for Cast Iron Mortise Except for 1" Deadlocks	1" - 1-3/4"	1161	\$108.00
1152	For Cast Iron Mortise with Optional Cam (Key Switches)	1" - 1-3/4"	1161G	
2153	Standard Cylinder for 8800FL, 8800, 8800RL, 350 Series Deadlocks	1" - 1-3/4"	2160	\$108.00
2123	Extra Length Cylinder for 8800FL, 8800, 8800RL	*1-7/8" - 3-1/2"	2160	\$150.00
2153S	Standard Inside Cylinder for 8817-2 Function	1" - 1-3/4"	2130	\$108.00
2123S	Extra Length Inside Cylinder for 8817-2 Function	*1-7/8" - 3-1/2"	2130	\$150.00
2553**	Schlage® "C" Keyway Cylinder 6-Pin - 0-bitted or Keyed Random	1-1/8"	2160	\$108.00
	7-Pin Cylinders	ADD	—	\$2.00

*Additional length available, price on application.

**2553 only available in 606, 612 and 626 finishes.

FIXED CORE RIM CYLINDERS:

MODEL #	PRODUCT DESCRIPTION	*ALL FINISHES
1109	Standard Cylinder	\$108.00
1709	CMK Cylinder (Price Includes Construction Master Keying)	\$124.00
2109**	Schlage® "C" Keyway Cylinder 6-Pin - 0-bitted or Keyed Random	\$108.00

*Rim cylinders not available in 629 or 630.

**Only available in 605, 606, and 626 finishes.

HOTEL CYLINDERS:

MODEL #	PRODUCT DESCRIPTION	LENGTH	CAM	ALL FINISHES
MORTISE				
1194H	LFIC Hotel Cylinder 6-Pin	1-11/16"	1160E	\$318.00
1196H	LFIC Hotel Cylinder 6-Pin for 310 Series Deadlocks	1-11/16"	1160R	
1719	Standard Hotel Cylinder 6-Pin for Cast Iron Mortise Locks	1-3/8"	1160	\$234.00
2196H	LFIC Hotel Cylinder 6-Pin	1-11/16"	2160	\$318.00
2719	Standard Hotel Cylinder 6-Pin	1-3/8"	2160	\$234.00
RIM				
1179	Standard Hotel Cylinder 6-Pin	1-5/8"	—	\$234.00

THUMBTURN CYLINDERS:

MODEL #	PRODUCT DESCRIPTION	LENGTHS	CAM	ALL FINISHES
S2053	Cylinder for 8800	1" or 1-1/8"	2160	\$127.00
S2053S	Inside Cylinder for 8834	1" or 1-1/8"	2130	

C900 SERIES CYLINDERS FOR ELECTRICAL SWITCHES:

PRODUCT DESCRIPTION	ALL FINISHES
C910, C910A, C910B, C910C, C910D	\$99.00
C911, C911A, C911B, C911C, C911D	\$114.00
C920, C920A, C920B, C920C, C920D	
C921, C921A, C921B, C921C, C921D	
C922, C922A, C922B, C922C, C922D	\$119.00
C930, C930A, C930B, C930C, C930D	\$136.00

If operated by two or more different keys, see page 27 for additional keying charges. Collar required must be specified.

Note: Cylinder plugs will be supplied in 606, 626, or BSP. Cylinder plugs with other manufacturers' keyways will be supplied in 606 or 626 only.

INTERCHANGEABLE CORE CYLINDERS

COMPLETE CYLINDERS:

MODEL #	PRODUCT DESCRIPTION	LENGTH	CAM	ALL FINISHES
MORTISE				
1194	LFIC Cylinder 6-Pin	1-1/2"	1160E	\$194.00
1194	LFIC Cylinder 7-Pin	1-11/16"	1160E	\$196.00
1196	LFIC Cylinder 6-Pin for 310 Series Mortise Deadlocks	1-1/2"	1160R	\$194.00
1196	LFIC Cylinder 7-Pin for 310 Series Mortise Deadlocks	1-11/16"	1160R	\$196.00
2196	LFIC Cylinder 6-Pin	1-1/2", 1-3/4", 2"	2160	\$194.00
2196S	LFIC Inside Cylinder 6-Pin for 8817-2 Function	1-1/2"	2130	\$194.00
2197	LFIC Cylinder 7-Pin	1-11/16", 2"	2160	\$196.00
2197S	LFIC Inside Cylinder 7-Pin for 8817-2 Function	1-11/16"	2130	\$196.00
RIM				
1193	LFIC Cylinder 6-Pin	—	—	\$194.00
1193	LFIC Cylinder 7-Pin	—	—	\$196.00
1193L	LFIC Cylinder 6-Pin with Lazy Cam	—	—	\$194.00

Note: Cylinder plugs and LFIC shells will be supplied in 606, 626, or BSP.

COMPLETE CYLINDERS:

MODEL #	PRODUCT DESCRIPTION	LENGTH	CAM	ALL FINISHES
MORTISE				
A620	SFIC Cylinder 6- or 7-Pin	1-1/4", 1-3/8", 1-3/4"	KC1	\$184.00
A630	SFIC Tapered Cylinder 6- or 7-Pin	1-1/4", 1-3/8"	KC1	\$188.00
RIM				
A640	SFIC Cylinder 6- or 7-Pin	1-1/4", 1-3/8"	KT1	\$184.00

Note: A620, A630 & A640 include Best® keyway core (A600), specify keyway.

*CORES ONLY:

MODEL #	PRODUCT DESCRIPTION	606/626/BSP FINISHES
1210	Large Format Core Only, 6-Pin	\$86.00
1210H	Large Format Core Only for Hotel Cylinders, 6-Pin	\$210.00
1220	Large Format Core Only, 7-Pin	\$88.00
A600**	Small Format Core Only, 6- or 7-Pin	\$76.00

*Prices include masterkeying or grand masterkeying.

**A600 available in 606 and 626 only.

NOTE: See page 36 for housing assemblies.

When Ordering: Specify finish.
Specify ring/collar size when ordering with cylinder.

CYLINDER COMPONENTS

***CYLINDER COLLARS:**

MODEL #	PRODUCT DESCRIPTION	ALL FINISHES
KP3	Wave Washer	\$6.00
KP4	Cylinder Collar for Rim Cylinders	
599	Recessed Cylinder Collar for Mortise and Rim	\$62.00
1765	Recessed Cylinder Collar for Mortise and Rim	\$51.00
	.062" - .219"	
	.250" - .656"	
1766	Tubular Spacer Collar for Mortise and Rim High Security	\$73.00
1767	Square Collar for Mortise and Rim	\$83.00

*Specify dimension. Cylinder collars not furnished with locksets or other products when ordered less cylinders. When cylinders ordered separately, collar length must be specified.

PLUGS ONLY:

PRODUCT DESCRIPTION	PARA(EIR) SECTION	ALL OTHER SECTIONS
Mortise Cylinders (i.e. 2153)	\$23.20	\$24.82
Rim Cylinders (i.e. 1109)		
Cylindrical Lock Cylinders (specify cylinder, i.e.1802)		
Hotel Cylinders (i.e. 1179)	\$26.20	\$27.82
Interchangeable Core (i.e.1210)	\$23.20	\$24.82
7-Pin Cylinder Plugs	ADD \$2.00	\$2.00

SHELLS ONLY:

PRODUCT DESCRIPTION	ALL FINISHES
Mortise Cylinder (i.e.2153)	\$50.00
Rim Cylinders (i.e. 1109 - 629, 630 not available)	
Cylindrical Lock Cylinder (i.e. 1802 - unfinished)	\$13.50
Hotel Cylinders (i.e. 1179)	\$58.00
7-Pin Cylinder Shells	ADD \$2.00

HOUSING ASSEMBLIES:

MODEL #	PRODUCT DESCRIPTION	*ALL FINISHES
1212	For 1193 Rim Cylinder (6-Pin)	\$108.00
1212B	For 1193 Rim Cylinder (7-Pin)	
1213	For 1196 Mortise Cylinder (7-Pin)	
1213	For 1196H Mortise Cylinder (6-Pin)	
1214	For 1194 Mortise Cylinder (6-Pin)	
1214H	For 1194 Mortise Cylinder (7-Pin)	
1214H	For 1194H Mortise Cylinder (6-Pin)	
1221	For 1196 Mortise Cylinder (6-Pin)	
2221	For 2196 Mortise Cylinder (6-Pin)	
2213	For 2197 & 2196H Mortise Cylinder (7-Pin)	
2214S	For 2196S Mortise Cylinder (6-Pin)	
2217S	For 2197S Mortise Cylinder (7-Pin)	
K660	SFIC Mortise Housing (1-1/4", 1-3/8", 1-3/4")	
K670	SFIC Tapered Mortise Housing (1-1/4", 1-3/8")	
K680	SFIC Rim Housing (1-1/4", 1-3/8")	\$108.00
K860	LFIC Mortise Housing (1-1/2", 1-11/16", 1-3/4", 2")	
K880	LFIC Rim Housing (1-7/16", 1-5/8")	

*Rim cylinders not available in 629 or 630.

Note: Cylinder plugs will be supplied in 606, 626, or BSP. Cylinder plugs with other manufacturers' keyways will be supplied in 606 or 626 only.

When Ordering: Specify finish.
Specify ring/collar size when ordering with cylinder.

SECURITY CYLINDERS

MODEL #	PRODUCT DESCRIPTION	CAM	ORDERED SEPARATELY	ORDERED WITH LOCKSET ADD
MORTISE				
5152	Security Cylinder 6-Pin	1161	\$425.00	\$317.00
5152	Security Cylinder 7-Pin	1161	\$429.00	\$321.00
5153	Security Cylinder 6-Pin	2160	\$425.00	\$317.00
5153	Security Cylinder 7-Pin	2160	\$429.00	\$321.00
5719	Security Hotel Cylinder 6-Pin (1-3/8")	2160	\$658.00	\$550.00
RIM				
5109	Security Cylinder 6-Pin	–	\$425.00	\$317.00
5109	Security Cylinder 7-Pin	–	\$429.00	\$321.00

MODEL #	NO. OF PINS	APPLICATIONS	606/626 FINISHES ORDERED SEPARATELY	ORDERED WITH LOCKSET ADD
COMPONENT: CYLINDRICAL LOCKS & EXIT DEVICE TRIM				
5801C	6	Optional for 5300 [^] & 5400 [^] series knob locks and 540F series trim	\$373.00	\$279.00
5801A	7	Optional for 5400 [^] series knob locks and 540F series trim	\$377.00	\$283.00
5802	6	Optional for 4700LN, 5300LN, 5400LN, 6400LN [^] & inTouch [®] series lever locks and 440F, 540F & 580F series trims	\$373.00	\$279.00
5802A	7	Optional for 5400LN & 6400LN series lever locks and 540F & 580F series trims	\$377.00	\$283.00
5812	6	Optional for 4300 [^] , 4300LN [^] & 4800LN [^] series knob/lever locks	\$373.00	\$279.00
5803-54L	6	Optional for Corbin Russwin CL3100(YC) & Sargent 11 Line (YC-) series lever locks. Optional for 4300LN [^] , 4600LN & 4800LN [^] series lever locks.		
5803A-54L	7	Optional for Corbin Russwin CL3100(YC7), Sargent 11 Line (YC-7P-) series lever locks.	\$377.00	\$283.00
5803-54K	6	Optional for 5400CK series knob locks and Heritage Collection lever locks	\$373.00	\$279.00
5803-53L	6	Optional for nexTouch [®] cylindrical series lever locks Optional for 4700LN, 5300LN & inTouch [®] series lever locks and 440F series trim		
5803-46K	6	Optional for 4600YC series knob locks		
5803-46L	6	Optional for Corbin Russwin CLX3300 (YC) & SARGENT 10X Line (YC-) series cylindrical locks, mechanical functions, 1-3/8" – 2" doors.		
5803-46LL	6	Optional for Corbin Russwin CLX3300 (YC) & SARGENT 10X Line (YC-) series cylindrical locks, mechanical functions, 2-1/4" doors.	\$377.00	\$283.00
5803A-46L	7	Optional for Corbin Russwin CLX3300 (YC7) & SARGENT 10X Line (YC-7P-) series cylindrical locks, mechanical functions, 1-3/8" – 2" doors.		
5803A-46LL	7	Optional for Corbin Russwin CLX3300 (YC7) & SARGENT 10X Line (YC-7P-) series cylindrical locks, mechanical functions, 2-1/4" doors.	\$373.00	\$279.00
5803-46E	6	Optional for Corbin Russwin CLX3300 (YC) & SARGENT 10X Line (YC-) series cylindrical locks, electrified functions, 1-3/8" – 2" doors.		
5803-46LE	6	Optional for Corbin Russwin CLX3300 (YC) & SARGENT 10X Line (YC-) series cylindrical locks, electrified functions, 2-1/4" doors.	\$377.00	\$283.00
5803A-46E	7	Optional for Corbin Russwin CLX3300 (YC7) & SARGENT 10X Line (YC-7P-) series cylindrical locks, electrified functions, 1-3/8" – 2" doors.		
5803A-46LE	7	Optional for Corbin Russwin CLX3300 (YC7) & SARGENT 10X Line (YC-7P-) series cylindrical locks, electrified functions, 2-1/4" doors.		
COMPONENT: DEADBOLTS				
5814	6	Optional for 4800LN [^] series deadbolt	\$425.00	\$331.00
5803-134S	6	Optional for Heritage Collection Deadbolt used with interconnected lock (non-face removable) Optional for D Series deadbolts, single cylinder functions	\$373.00	\$279.00
5803-134D	6	Optional for D Series deadbolts, double cylinder functions		

Note: Cylinder plugs will be supplied in 606, 626, or BSP. Cylinder plugs with other manufacturers' keyways will be supplied in 606 or 626 only.
^Lockset series obsolete

SECURITY CYLINDERS WITH INTERCHANGEABLE CORE

MODEL #	PRODUCT DESCRIPTION	LENGTH	CAM	ORDERED SEPARATELY	ORDERED WITH LOCKSET ADD
MORTISE - COMPLETE					
5194	LFIC Security Cylinder 6-Pin	1-1/2"	1160E	\$526.00	\$418.00
5194	LFIC Security Cylinder 7-Pin	1-11/16"	1160E	\$530.00	\$422.00
5196	LFIC Security Cylinder 6-Pin	1-1/2"	2160	\$526.00	\$418.00
5196S	LFIC Security Inside Cylinder 6-Pin for 8817-2 Function	1-1/2"	2130		
5196H	LFIC Security Hotel Cylinder 6-Pin	1-11/16"	2160	\$846.00	\$738.00
5197	LFIC Security Cylinder 7-Pin	1-11/16"	2160	\$530.00	\$422.00
5197S	LFIC Security Inside Cylinder 7-Pin for 8817-2 Function	1-11/16"	2130		
RIM - COMPLETE					
5193	LFIC Security Cylinder 6-Pin	—	—	\$526.00	\$418.00
5193	LFIC Security Cylinder 7-Pin	—	—	\$530.00	\$422.00
CORES ONLY					
5210	Large Format Security Core Only 6-Pin	—	—	\$343.00	\$343.00
5220	Large Format Security Core Only 7-Pin	—	—	\$347.00	\$347.00
5210H	Large Format Security Core Only for Hotel Cylinders 6-Pin	—	—	\$702.00	\$702.00

Note: Cylinder plugs and LFIC shells will be supplied in 606, 626, or BSP.

NOTE: Security systems typically use the "A" key bow, although conventional systems can also use this bow. Ordering AN11 or AN117 does not guarantee security blanks. All orders for security keyblanks must be specific and reference the master key systems registry numbers, if existing. All orders for security keyblanks must also be accompanied by proper authorization.

NOTE: All Security Cylinders and High Security Cylinders includes Master Keying or Grand Master Keying. Construction Master Keying not available. Cylinders "0" Bitted, no deduct.

When Ordering: Specify finish.

U.L. HIGH SECURITY CYLINDERS

MODEL #	PRODUCT DESCRIPTION	CAM	ORDERED SEPARATELY	ORDERED WITH LOCKSET ADD
MORTISE				
U5152	High Security Cylinder 6-Pin	1161	\$569.00	\$461.00
U5152	High Security Cylinder 7-Pin	1161	\$573.00	\$465.00
U5153	High Security Cylinder 6-Pin	2160	\$569.00	\$461.00
U5153	High Security Cylinder 7-Pin	2160	\$573.00	\$465.00
U5719	High Security Hotel Cylinder 6-Pin	2160	\$789.00	\$681.00
RIM				
U5109	High Security Cylinder 6-Pin	—	\$569.00	\$461.00
U5109	High Security Cylinder 7-Pin	—	\$573.00	\$465.00

Note: Cylinder plugs will be supplied in 606, 626, or BSP. Cylinder plugs with other manufacturers' keyways will be supplied in 606 or 626 only.

SECURITY KEYS

PRODUCT DESCRIPTION	ORDERED SEPARATELY
Extra Change Keys	\$19.40
Key Blanks & Control Key Blanks	\$19.10
Master Keys & Control Keys	\$19.40
All Security Keys Requested with Conventional Cylinders (each key)	\$19.40

NOTE: Security systems typically use the "A" key bow, although conventional systems can also use this bow. Ordering AN11 or AN117 does not guarantee security blanks. All orders for security keyblanks must be specific and reference the master key systems registry numbers, if existing. All orders for security keyblanks must also be accompanied by proper authorization.

NOTE: All Security Cylinders and High Security Cylinders includes Master Keying or Grand Master Keying. Construction Master Keying not available. Cylinders "0" Bitted, no deduct.

When Ordering: Specify finish.

KEYING KITS

KEYING KITS:

PRODUCT DESCRIPTION	LIST PRICE
SK-12 (.019" Step)	\$364.00
SK-13 (.025" Step)	
R19 Refill Set (.019" Step)	\$177.00
R25 Refill Set (.025" Step)	
020 Plug Follower for .51" plug (plastic)	\$24.40
021 Tweezers	\$29.50
DK1 Depth Keys	\$202.00
KG1 Key Gauge (.019" and .025" step)	\$23.80

CYLINDER PINS

.51 CYLINDER PINS AND SPRINGS:

MODEL #	PRODUCT DESCRIPTION	LIST PRICE	PKG. OF 100
151	Cylinder Spring	\$20.80	PKG.
251	Bottom Pins - .019" step (indicate size 0-9)		PKG.
251A	Bottom Pins - .025" step (indicate size 0-7)		PKG.
351	Top Pins - .019"/.025" steps (indicate size 1-4)		PKG.
451	Master Pins - .019" step (indicate size 2-8)		PKG.
451A	Master Pins - .025" step (indicate size 2-7)		PKG.
751-3	BUMP Pins - .019" step (Qty. 300)	\$262.00	—

When Ordering: Specify finish.

CYLINDER CAMS

CYLINDER CAMS:

MODEL #	PRODUCT DESCRIPTION	LIST PRICE EACH
1160	Std for 1153, S1053H, 1719, 5719, U5719	\$8.02
1160E	Std for 1194, 1194H, 5194, 5194H	
1160L	Opt for 1194, 1194H, 5194, 5194H	
1161	Std for 1123, 1152, S1052H, 5152, U5152	
1161E	Opt for 1194, Std for 2153 when used for 2100 cylinder dogging	
1161G	Opt for 1194, 1194H, 5194, 5194H	
1161L	Opt for 1123, 1152, S1052H, 5152, U5152	
1161U	Opt for 1194, 1194H, 5194, 5194H	
1161T	Opt for 1123, 1152, 1186, S1052H, 5152, U5152	
2130	Std for 2123S, 2153S, S2053S, 2196S, 2197S, 5196S, 5197S	
2160	Std for 2123, 2153, S2053, 2719, 5153, U5153, 5719, 2196, 2197, 2196H, 5196, 5197, 5196H	
10-6120-9010	Cam Disc	

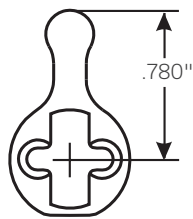

No. 1160

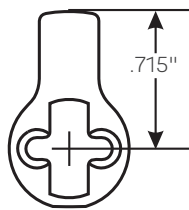

No. 1161

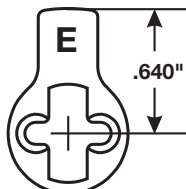

No. 1161E

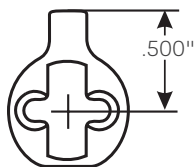
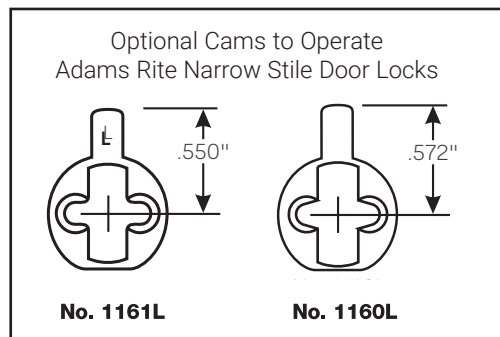

No. 2130

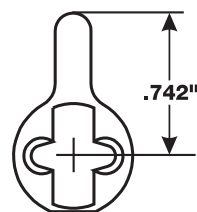

No. 2160*



Part No.
10-6120-9010

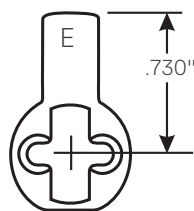

No. 1160E

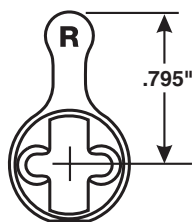

No. 1160R

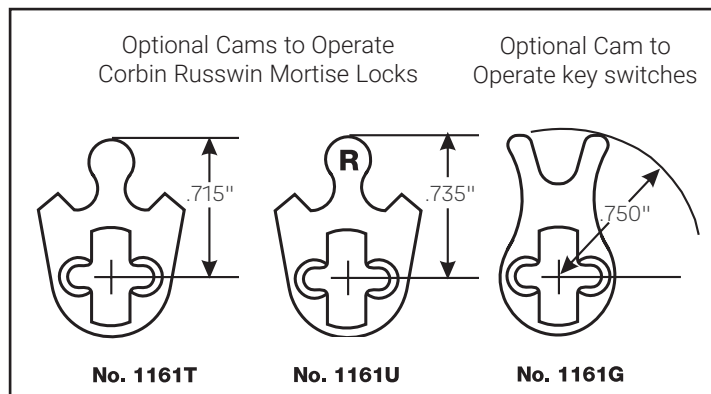

All cams and cam discs illustrated actual size.

*Will also operate Sargent® mortise locks.

When Ordering: Specify finish.

MISCELLANEOUS:

MODEL #	PRODUCT DESCRIPTION	LIST PRICE
1145	Connecting Bar Regular for 1109-1179	\$3.06
1147	Connecting Bar Long for 1109	
1151	Connecting Screw Regular for 1109-1179	\$2.26
1151A	Connecting Screw Long for 1109	
1451	Retainer for 1109-1179	\$1.54
1451A	Retainer for 1709-1179	
9072	Spring	
10-1194-2302-999	Spring Cover for 1210 Core, Fixed Core Mortise & Rim	\$0.92
10-1194-2303-999	Spring Cover for 1220 Core, Fixed Core Mortise & Rim	
013	Plug Nut	\$7.02
014	Plug Nut Retainer	\$1.52
1191 1/2	Knob Screw	
9999-4561	Plug Retainer	
99-9999-4525-999	Plug Retainer Snap Ring	

LOCKSMITH'S REPAIR

PRODUCT #	PRODUCT DESCRIPTION	LIST PRICE
018	Plug Follower for .51" (metal)	\$84.00
022	Plug Follower for .40" (metal)	\$279.00
M33	Vice held plug holder for set up (multiple plug diameters)	\$330.00
M36	Set up plug for .51" cylinder	\$1,069.00
M38	Set up plug for .40" cylinder	\$1,285.00
M43	Shove Knife	\$72.00

OPTIONS:

PREFIX	DESCRIPTION	LIST PRICE
D	Dust Guard, Prefix to Cylinder Model Number	ADD \$72.00
SP	Steel Pin, Prefix to Cylinder Model Number	

SUFFIX	DESCRIPTION	LIST PRICE
BUMP	BUMP Resistant Cylinders - Suffix to Cylinder Model Number	ADD \$38.00

ACCENTRA KEYMARK® KEYING CHARGES, KEYS AND KEY BLANKS

MASTERKEY SERVICES: The value-added service of a customized masterkey security solution is provided when requested for a nominal charge with the purchase of complete ACCENTRA keyed locking devices. In addition to the standard masterkeying charge, a masterkey service charge will be assessed, based on quantity, cylinder type, key system type, for an order that includes only ACCENTRA cylinders or cores for use in non-ACCENTRA manufactured locking devices for which ACCENTRA has an equivalent.

KEYING CHARGES:

PRODUCT DESCRIPTION		LIST PRICE
Masterkeying, Grand Masterkeying, Great Grand Masterkeying (all fixed core cylinders, charge for each cylinder)	ADD	\$16.00
Masterkeying, Grand Masterkeying, Great Grand Masterkeying (LFIC and SFIC Cores)	ADD	\$0.00
Uncombined Cylinders and Cores - key blanks not included	DEDUCT	\$5.00

CONSTRUCTION MASTER KEYING:

For security reasons, ACCENTRA KeyMark® cylinders are not available construction master keyed. Temporary construction cores are available for both SFIC and LFIC. Temporary cores for SFIC are available with either disposable or locking cores. Temporary cores for LFIC are available with only lockable cores. Temporary cores are not available in competitor formats. See page 31 for construction core program.

VISUAL CYLINDER/KEY CONTROL:

Description	Cylinders		Keys	
	Stamping	List Price	Stamping	List Price
VKC0 - No stamping except keyway designation (keys will be tagged)	No Stamping	No Charge	No Stamping	\$5.00/key
VKC1 - Keys only	N/A	No Charge	Keyset	No Charge
VKC2 - Cylinder and keys*	Keyset	\$4.00/cyl	Keyset	No Charge
VKC3 - Cylinder*	Keyset	\$4.00/cyl	Bitings	No Charge
All VKC, VDC or VAC stamping codes that using alternate symbol	Alternate Stamping	\$4.00/cyl	Alternate Stamping	\$4.00/key

CONCEALED CYLINDER/VISUAL KEY CONTROL:

Description	Cylinders		Keys	
	Stamping	List Price	Stamping	List Price
CKC2 - Cylinder and keys*	Keyset	\$4.00/cyl	Keyset	No Charge
CKC3 - Cylinders only*	Keyset	\$4.00/cyl	Bitings	No Charge
All CKC, CDC or CAC stamping codes that using alternate symbol	Alternate Stamping	\$4.00/cyl	Alternate Stamping	\$4.00/key

*Cylinder face stamping not available for ACCENTRA KeyMark®, security, and high security products

NOTE: See page 7 for code definitions and examples

KEYS:

PRODUCT DESCRIPTION		LIST PRICE
Master Keys and Control Keys - each	--	\$15.40
Two Keys ordered with cylinder/lockset (standard)	--	\$0.00
Extra Change Keys ordered with cylinder/lockset - each	ADD	\$15.40
Change Keys ordered separately - each	--	

KEY BLANKS:

PRODUCT DESCRIPTION		LIST PRICE
Single Section 6 & 7 pin	EACH	\$7.80
Multi-Section 6 & 7 pin	EACH	\$8.60
Control Keys KN117C, 118C, 91C	EACH	

NOTE: Key blanks can not be substituted for cut keys.

When Ordering: Specify finish.

MORTISE CYLINDERS: SPECIFY 6 OR 7 PIN

MODEL #	PRODUCT DESCRIPTION	LENGTHS	ALL FINISHES
K100	Fixed Core Mortise Cylinder	1-1/8", 1-1/4"	\$126.00
K100	Fixed Core Mortise Cylinder	1-1/2", 1-3/4", 2"	\$267.00
K620	SFIC Mortise Cylinder	1-1/4", 1-3/8", 1-3/4"	\$228.00
K630	SFIC Tapered Mortise Cylinder	1-1/4", 1-3/8"	\$231.00
K820	LFIC Mortise Cylinder	1-1/2", 1-11/16", 1-3/4", 2"	\$234.00

RIM CYLINDERS: SPECIFY 6 OR 7 PIN

MODEL #	PRODUCT DESCRIPTION	LENGTHS	ALL FINISHES
K300	Fixed Core Rim Cylinder	1-1/8"	\$136.00
K640	SFIC Rim Cylinder	1-1/4", 1-3/8"	\$228.00
K840	LFIC Rim Cylinder	1-7/16", 1-5/8"	\$234.00

CYLINDRICAL LOCKS & EXIT DEVICE TRIM

MODEL #	NO. OF PINS	APPLICATIONS	606/626/BSP FINISHES
CYLINDRICAL LOCKS & EXIT DEVICE TRIM			
K400	6	Optional for 5300 [^] & 5400 [^] series knob locks and 540F series trim	\$118.00
K402	6	Optional for 4700LN, 5300LN, 5400LN, 6400LN [^] & inTouch [™] series lever locks and 440F, 540F & 580F series trims	
K402	7	Optional for 5400LN & 6400LN [^] series lever locks and 540F series trim	
K404	6	Optional for 4800LN [^] series lever locks	
K490	6	Optional for Schlage [™] A, D & ND series lever locks	\$126.00
K403-54L	6	Optional for Corbin Russwin CL3100(YC) & Sargent 11 Line (YC-) series lever locks. Optional for 4600LN & 4800LN [^] series lever locks.	\$118.00
K403A-54L	7	Optional for Corbin Russwin CL3100(YC7), Sargent 11 Line (YC-7P-) series lever locks	
K403-54K	6	Optional for 5400CK series knob locks and Heritage Collection lever locks	
K403-53L	6	Optional for nexTouch [®] cylindrical series lever locks and inTouch [™] series lever locks	
K403-47L	6	Optional for 4700LN, 5300LN and 440F series trim	
K403-46K	6	Optional for 4600YC series knob locks	
K403-46L	6	Optional for Corbin Russwin CLX3300 (YC) & SARGENT 10X Line (YC-) series cylindrical locks, mechanical functions, 1-3/8" – 2" doors.	
K403-46LL	6	Optional for Corbin Russwin CLX3300 (YC) & SARGENT 10X Line (YC-) series cylindrical locks, mechanical functions, 2-1/4" doors.	
K403A-46L	7	Optional for Corbin Russwin CLX3300 (YC7) & SARGENT 10X Line (YC-7P-) series cylindrical locks, mechanical functions, 1-3/8" – 2" doors.	
K403A-46LL	7	Optional for Corbin Russwin CLX3300 (YC7) & SARGENT 10X Line (YC-7P-) series cylindrical locks, mechanical, 2-1/4" doors.	
K403-46E	6	Optional for Corbin Russwin CLX3300 (YC) & SARGENT 10X Line (YC-) series cylindrical locks, electrified functions, 1-3/8" – 2" doors.	
K403-46LE	6	Optional for Corbin Russwin CLX3300 (YC) & SARGENT 10X Line (YC-) series cylindrical locks, electrified functions, 2-1/4" doors.	
K403A-46E	7	Optional for Corbin Russwin CLX3300 (YC7) & SARGENT 10X Line (YC-7P-) series cylindrical locks, electrified functions, 1-3/8" – 2" doors.	
K403A-46LE	7	Optional for Corbin Russwin CLX3300 (YC7) & SARGENT 10X Line (YC-7P-) series cylindrical locks, electrified functions, 2-1/4" doors.	
DEADBOLTS			
K202	6	Optional for 4800LN [^] series deadbolt	\$118.00
K290	6	Optional for Schlage [™] B series deadbolt	\$126.00
K403-134S	6	Optional for Heritage Collection Deadbolt used with interconnected lock (non-face removable) Optional for D Series deadbolts, single cylinder functions	\$118.00
K403-134D	6	Optional for D Series deadbolts, double cylinder functions	

CORES: SPECIFY 6 OR 7 PIN

MODEL #	PRODUCT DESCRIPTION	606/626/BSP FINISHES
K600**	SFIC Core	\$120.00
K800	LFIC Core	\$126.00
K890	LFIC Core for Schlage	

Note: Cylinder plugs will be supplied in 606, 626, or BSP. Cylinder plugs with other manufacturers' keyways will be supplied in 606 or 626 only.

[^] Lockset series obsolete

**K600 available in 606 and 626 only.

HOUSINGS: SPECIFY 6 OR 7 PIN

MODEL #	PRODUCT DESCRIPTION	LENGTHS	ALL FINISHES
K660	SFIC Mortise Housing	1-1/4", 1-3/8", 1-3/4"	\$108.00
K670	SFIC Tapered Mortise Housing	1-1/4", 1-3/8"	\$111.00
K680	SFIC Rim Housing	1-1/4", 1-3/8"	\$108.00
K860	LFIC Mortise Housing	1-1/2", 1-11/16", 1-3/4", 2"	
K880	LFIC Rim Housing	1-7/16", 1-5/8"	

When Ordering: Specify finish.

CYLINDER PLUGS: 6-PIN & 7-PIN

MODEL #	PRODUCT DESCRIPTION	LENGTHS	EACH
K150	Mortise - order in multiples of 10	1-1/8", 1-1/4"	\$55.00
K150	Mortise - order in multiples of 10	1-1/2"	\$72.00
K250	Deadlocks - order in multiples of 10	--	\$55.00
K350	Rim - order in multiples of 10	1-1/8"	
K450	Key In Knob/Lever - order in multiples of 10	--	
K850	Large Format IC - order in multiples of 10	--	
SFIC	Not Available - order K600 UC	--	--

Note: Cylinder plugs will be supplied in 606, 626, or BSP.

CYLINDER SHELLS: 6-PIN & 7-PIN

MODEL #	PRODUCT DESCRIPTION	LENGTHS	ALL FINISHES EACH
K151	0.1875 in	1-1/8", 1-1/4"	\$84.00
K151	Mortise - order in multiples of 1 each	1-1/2"	\$222.00
K251	Deadlocks - order in multiples of 10	--	\$84.00
K351	Rim - order in multiples of 10	--	
K451	Key In Knob/Lever - order in multiples of 10	--	
K851	Large Format IC - order in multiples of 10	--	
SFIC	Not Available - order K600 UC	--	--

PINS, SPRINGS & CAPS

MODEL #	PRODUCT DESCRIPTION	EACH
K702-K719*	Master, Build Up & Top Pins - order in multiples of 100	\$0.12
K720-K729*	Bottom Pins - order in multiples of 100	\$0.12
K730	Tumbler Springs - order in multiples of 100	\$0.04
K731	Pin Chamber Caps for K600 - order in multiples of 100	
K732	Spring Cover 6-Pin for K800 - order in multiples of 100	\$0.79
K733	Spring Cover 7-Pin for K800 - order in multiples of 100	
K734	Spring Cover 6-Pin for K200 & K400 - order in multiples of 100	
K735	Spring Cover 7-Pin for K200 & K400 - order in multiples of 100	
K736	Set Screws for K100 & K300 - order in multiples of 100	\$0.47

* Refer to ACCENTRA KeyMark® Service Manual (42250) for details on pin sizes.

When Ordering: Specify finish on plugs and shells.

TAILPIECES, CAMS & COLLARS

MODEL #	PRODUCT DESCRIPTION	EACH
K739	Plug Retainer for K300 - order in multiples of 10	\$2.24
K740	Plug Retainer for K800 - order in multiples of 10	
K741	Plug Retainer for K200 & K400 - order in multiples of 10	
KC1-KC10*	Cams - Packs of 20 each	\$72.22/Pk
KP1	Cam Washers - order in multiples of 100	\$1.40
KP2	Cam Screws - order in multiples of 100	\$0.80
KP4	Collars in all finishes - order in multiples of 10	\$6.00
KT1	Break Off Tailpiece & Retainer for K300 & K640 & K840 - order in multiples of 10	\$4.94
KT2-KT7*	Tailpiece for K200 & K400 - Packs of 10 each	\$16.08
KT8	Tailpiece for K202 - Packs of 10 each	\$18.60

* Refer to ACCENTRA KeyMark® Service Manual (42250) for details on cams and tailpieces.

ACCENTRA KEYMARK® TOOLS AND SERVICE EQUIPMENT

TOOLS & EQUIPMENT

MODEL #	PRODUCT DESCRIPTION	EACH
K915	Key Gauge	\$38.00
K918	Pin Kit	\$599.00

When Ordering: Specify finish on plugs and shells.

8800 SERIES MORTISE LOCK VARIATIONS



Hurricane

STANDARD FINISHES: Product will be furnished only in the finishes in which it is priced.

ANSI/BHMA CODE	FINISH DESCRIPTION
BRASS:	
605	Bright Brass, Clear Coated
606	Satin Brass, Clear Coated
BRONZE:	
611	Bright Bronze
612	Satin Bronze, Clear Coated
613E	Dark Oxidized Satin Bronze - equivalent

ANSI/BHMA CODE	FINISH DESCRIPTION
CHROME:	
625	Bright Chrome Plated
626	Satin Chrome Plated
STAINLESS STEEL:	
629	Bright Stainless Steel
630	Satin Stainless Steel
NICKEL:	
618	Bright Nickel Plated, Clear Coated
619	Satin Nickel Plated, Clear Coated
PAINTED:	
693	Black Painted
BSP	Black Suede Powder Coat
WSP	White Suede Powder Coat

PRODUCT OPTIONS	DEDUCT	ADD
LESS CYLINDER: Specify "x LC" Cylinder rings/collars not furnished with locksets ordered less cylinders.	\$108.00	--
Hotel Function Locksets - Less Cylinder	\$234.00	--
IC Housing ordered with locksets (ICLC)	--	\$0.00
7-PIN CYLINDERS: Add to 6-Pin cylinder	--	\$2.00
DUST GUARD: Prefix "D" to model number (refer to catalog for available cylinders)	--	\$72.00
INTERCHANGEABLE CORE CYLINDERS:		
2196 - LFIC 6-Pin (Includes MK or GMK) Ordering Example: AUR8807FL x 2196 x RH x 626	--	\$86.00
2196H - LFIC Hotel Lock (Includes MK or GMK and EMK)	--	\$210.00
A620 - SFIC 6-or 7-Pin (Includes MK or GMK) Ordering Example: AUR8807 x A620 x RH x 626	--	\$76.00
TORX® SECURITY HEAD SCREWS: Standard size only (add for each screw)	--	\$1.00
Quantity Required: Sectional Trim = 4	--	\$4.00
Escutcheon Trim = 6	--	\$6.00
SPECIAL STRIKES:		
Strikes with lip lengths other than 1-1/8" or 1-1/4"	--	\$19.00
SPLIT DESIGNS AND SPLIT FINISHES		
	Higher List Price Applies	
LEAD LINED	--	\$439.00
KNURLING: Available for all knob and levers in any finish except HA, PN and all Reflections® levers		
Outside (KNO) or Inside (KNI) Only	--	\$116.00
Both Sides (KNB)	--	\$232.00
ABRASIVE COATING: Knob or Lever		
Outside (ABCO) or Inside (ABCI) Only	--	\$71.00
Both Sides (ABCB)	--	\$142.00
DOORS 1-7/8" THICK TO 3-1/4" THICK: With lock centered in the door. SPAR required for locks not centered in door.		
Non-keyed	--	\$158.00
Single cylinder keyed	--	\$250.00
Double cylinder keyed	--	\$280.00
INDICATORS	See Page 56	
MICROSHIELD®: Antimicrobial coating. Specify option "YMS"	--	\$101.00

8800FL SERIES MORTISE LOCKS

LEVER DESIGNS: Augusta - AU
Carmel - CR

Monroe - MO
Pacific Beach - PB

ROSE DESIGNS: Copenhagen - R
R3, R4, R5, R6, R7, R8, R9

MODEL #	PRODUCT DESCRIPTION	613E 626 BSP WSP	605 606 611 612 618 619 625 629 ² 630 ² 693
SINGLE CYLINDER:			
8805FL	Storeroom or Closet	\$1,037.00	\$1,061.00
8807FL	Entrance		
8808FL	Classroom		
8809FL	Classroom or Office with Thumbturn	\$1,051.00	\$1,075.00
8824FL	Hold Back	\$1,037.00	\$1,061.00
8829FL	Closet		
8833FL	Exit		
8834FL	All Purpose		
8864FL ³	Bathroom with Indicator		
SINGLE CYLINDER WITH DEADBOLT:			
8822FL	Dormitory	\$1,064.00	\$1,088.00
8823FL	Storeroom		
8840FL	Storeroom		
8847FL	Entrance or Apartment		
8860FL	Entrance or Storeroom		
8861FL	Dormitory or Storeroom		
8867FL	Dormitory or Exit		
DOUBLE CYLINDER:			
8808-2FL	Classroom	\$1,145.00	\$1,169.00
8817-2FL	Apartment, Exit or Public Toilet		
8830-2FL	Asylum		
8834-2FL	All Purpose		
DOUBLE CYLINDER WITH DEADBOLT:			
8811-2FL	Classroom Deadbolt	\$1,172.00	\$1,196.00
8812-2FL	Classroom Security		
8818-2FL	Classroom Security Intruder		
8860-2FL	Entrance or Storeroom		
HOTEL/MOTEL:			
8820FL ^{1,3}	Hotel/Motel	\$1,191.00	\$1,215.00
8827FL ^{1,3}	Hotel/Motel		
8832FL	Hotel/Motel	\$1,163.00	\$1,187.00
NON-KEYED:			
8801FL	Passage	\$908.00	\$932.00
8802FL	Privacy	\$956.00	\$980.00
8828FL	Exit	\$908.00	\$932.00
8835FL	Exit with Thumbturn	\$949.00	\$973.00
8862FL	Bathroom	\$929.00	\$953.00
8865FL	Bathroom with Thumbturn	\$943.00	\$967.00
8866FL	Passage Lock w/ Indicator (VXX option add pg 56 also applies)	\$929.00	\$953.00
DUMMY TRIM:			
855FL	Single	\$397.00	\$409.00
838AFL	Pair	\$794.00	\$818.00
838BFL	Pair (Strike available upon request)	\$826.00	\$850.00
8870FLDT	Plain	\$908.00	\$932.00
8871FLDT	Latchbolt		
8872FLDT	Latchbolt x Deadbolt		

1. Price Includes Hotel Indicator.
2. Levers are Nickel Plated to match Stainless Steel.
3. Not available with R9 rose.

When Ordering: Specify design, hand and finish.

8800FL SERIES MORTISE LOCKS

LEVER DESIGNS: Augusta - AU
Carmel - CR

Monroe - MO
Pacific Beach - PB

ESCUTCHEON DESIGNS: Camden - CN
E3, E4, VN³

MODEL #	PRODUCT DESCRIPTION	613E 626 BSP WSP	605 606 611 612 618 619 625 629 ² 630 ² 693
SINGLE CYLINDER:			
8805FL	Storeroom or Closet	\$1,059.00	\$1,083.00
8807FL	Entrance		
8808FL	Classroom	\$1,073.00	\$1,097.00
8809FL	Classroom or Office with Thumbturn		
8824FL	Hold Back	\$1,059.00	\$1,083.00
8829FL	Closet		
8833FL	Exit		
8834FL	All Purpose		
8864FL	Bathroom with Indicator		
8864FL	Bathroom with Indicator	\$1,264.00	\$1,288.00
SINGLE CYLINDER WITH DEADBOLT:			
8822FL	Dormitory	\$1,086.00	\$1,110.00
8823FL	Storeroom		
8840FL	Storeroom		
8847FL	Entrance or Apartment		
8860FL	Entrance or Storeroom		
8861FL	Dormitory or Storeroom		
8867FL	Dormitory or Exit		
DOUBLE CYLINDER:			
8808-2FL	Classroom	\$1,167.00	\$1,191.00
8817-2FL	Apartment, Exit or Public Toilet		
8830-2FL	Asylum		
8834-2FL	All Purpose		
DOUBLE CYLINDER WITH DEADBOLT:			
8811-2FL	Classroom Deadbolt	\$1,194.00	\$1,218.00
8812-2FL	Classroom Security		
8818-2FL	Classroom Security Intruder		
8860-2FL	Entrance or Storeroom		
HOTEL/MOTEL:			
8820FL ¹	Hotel/Motel	\$1,213.00	\$1,237.00
8827FL ¹	Hotel/Motel		
8832FL	Hotel/Motel	\$1,185.00	\$1,209.00
NON-KEYED:			
8801FL	Passage	\$930.00	\$954.00
8802FL	Privacy	\$978.00	\$1,002.00
8828FL	Exit	\$930.00	\$954.00
8835FL	Exit with Thumbturn	\$971.00	\$995.00
8862FL	Bathroom	\$951.00	\$975.00
8865FL	Bathroom with Thumbturn	\$965.00	\$989.00
8866FL	Passage Lock w/ Indicator (VXX option add pg 56 also applies)	\$951.00	\$975.00
DUMMY TRIM:			
855FL	Single	\$408.00	\$420.00
838AFL	Pair	\$816.00	\$840.00
838BFL	Pair (Strike available upon request)	\$848.00	\$872.00
8870FLDT	Plain	\$930.00	\$954.00
8871FLDT	Latchbolt		
8872FLDT	Latchbolt x Deadbolt		

1. Price Includes Hotel Indicator.
2. Levers and Escutcheons are Nickel Plated to match Stainless Steel.
3. VN escutcheon available only with indicators. Must be ordered with "V" indicator options. See page 56 for more information. Option add also applies.

When Ordering: Specify design, hand and finish.

8800FL SERIES MORTISE LOCKS

LEVER DESIGNS: Arcadia - AR
Jefferson - JN

Pinehurst - PN
Virginia - VI

ROSE DESIGNS: Copenhagen - R
R3, R4, R5, R6, R7, R8, R9

MODEL #	PRODUCT DESCRIPTION	613E 626 BSP WSP	605 606 611 612 618 619 625 629 ² 630 ² 693
SINGLE CYLINDER:			
8805FL	Storeroom or Closet	\$1,204.00	\$1,228.00
8807FL	Entrance		
8808FL	Classroom		
8809FL	Classroom or Office with Thumbturn	\$1,218.00	\$1,242.00
8824FL	Hold Back	\$1,204.00	\$1,228.00
8829FL	Closet		
8833FL	Exit		
8834FL	All Purpose		
8864FL ³	Bathroom with Indicator	\$1,409.00	\$1,433.00
SINGLE CYLINDER WITH DEADBOLT:			
8822FL	Dormitory	\$1,231.00	\$1,255.00
8823FL	Storeroom		
8840FL	Storeroom		
8847FL	Entrance or Apartment		
8860FL	Entrance or Storeroom		
8861FL	Dormitory or Storeroom		
8867FL	Dormitory or Exit		
DOUBLE CYLINDER:			
8808-2FL	Classroom	\$1,312.00	\$1,336.00
8817-2FL	Apartment, Exit or Public Toilet		
8830-2FL	Asylum		
8834-2FL	All Purpose		
DOUBLE CYLINDER WITH DEADBOLT:			
8811-2FL	Classroom Deadbolt	\$1,339.00	\$1,363.00
8812-2FL	Classroom Security		
8818-2FL	Classroom Security Intruder		
8860-2FL	Entrance or Storeroom		
HOTEL/MOTEL:			
8820FL ^{1,3}	Hotel/Motel	\$1,358.00	\$1,382.00
8827FL ^{1,3}	Hotel/Motel		
8832FL	Hotel/Motel	\$1,330.00	\$1,354.00
NON-KEYED:			
8801FL	Passage	\$1,075.00	\$1,099.00
8802FL	Privacy	\$1,123.00	\$1,147.00
8828FL	Exit	\$1,075.00	\$1,099.00
8835FL	Exit with Thumbturn	\$1,116.00	\$1,140.00
8862FL	Bathroom	\$1,096.00	\$1,120.00
8865FL	Bathroom with Thumbturn	\$1,110.00	\$1,134.00
8866FL	Passage Lock w/ Indicator (VXX option add pg 56 also applies)	\$1,096.00	\$1,120.00
DUMMY TRIM:			
855FL	Single	\$480.50	\$492.50
838AFL	Pair	\$961.00	\$985.00
838BFL	Pair (Strike available upon request)	\$993.00	\$1,017.00
8870FLDT	Plain	\$1,075.00	\$1,099.00
8871FLDT	Latchbolt		
8872FLDT	Latchbolt x Deadbolt		

1. Price Includes Hotel Indicator.
2. Levers are Nickel Plated to match Stainless Steel.
3. Not available with R9 rose.

When Ordering: Specify design, hand and finish.

8800FL SERIES MORTISE LOCKS

LEVER DESIGNS:

Arcadia - AR Pinehurst - PN
Jefferson - JN Virginia - VI

ESCUTCHEON DESIGNS:

Camden - CN
E3, E4, VN³

MODEL #	PRODUCT DESCRIPTION	613E 626 BSP WSP	605 606 611 612 618 619 625 629 ² 630 ² 693
SINGLE CYLINDER:			
8805FL	Storeroom or Closet	\$1,226.00	\$1,250.00
8807FL	Entrance		
8808FL	Classroom	\$1,240.00	\$1,264.00
8809FL	Classroom or Office with Thumbturn		
8824FL	Hold Back	\$1,226.00	\$1,250.00
8829FL	Closet		
8833FL	Exit		
8834FL	All Purpose		
8864FL	Bathroom with Indicator		
SINGLE CYLINDER WITH DEADBOLT:			
8822FL	Dormitory	\$1,253.00	\$1,277.00
8823FL	Storeroom		
8840FL	Storeroom		
8847FL	Entrance or Apartment		
8860FL	Entrance or Storeroom		
8861FL	Dormitory or Storeroom		
8867FL	Dormitory or Exit		
DOUBLE CYLINDER:			
8808-2FL	Classroom	\$1,334.00	\$1,358.00
8817-2FL	Apartment, Exit or Public Toilet		
8830-2FL	Asylum		
8834-2FL	All Purpose		
DOUBLE CYLINDER WITH DEADBOLT:			
8811-2FL	Classroom Deadbolt	\$1,361.00	\$1,385.00
8812-2FL	Classroom Security		
8818-2FL	Classroom Security Intruder		
8860-2FL	Entrance or Storeroom		
HOTEL/MOTEL:			
8820FL ¹	Hotel/Motel	\$1,380.00	\$1,404.00
8827FL ¹	Hotel/Motel		
8832FL	Hotel/Motel	\$1,352.00	\$1,376.00
NON-KEYED:			
8801FL	Passage	\$1,097.00	\$1,121.00
8802FL	Privacy	\$1,145.00	\$1,169.00
8828FL	Exit	\$1,097.00	\$1,121.00
8835FL	Exit with Thumbturn	\$1,138.00	\$1,162.00
8862FL	Bathroom	\$1,118.00	\$1,142.00
8865FL	Bathroom with Thumbturn	\$1,132.00	\$1,156.00
8866FL	Passage Lock w/ Indicator (VXX option add pg 56 also applies)	\$1,118.00	\$1,142.00
DUMMY TRIM:			
855FL	Single	\$491.50	\$503.50
838AFL	Pair	\$983.00	\$1,007.00
838BFL	Pair (Strike available upon request)	\$1,015.00	\$1,039.00
8870FLDT	Plain	\$1,097.00	\$1,121.00
8871FLDT	Latchbolt		
8872FLDT	Latchbolt x Deadbolt		

1. Price Includes Hotel Indicator.
2. Levers and Escutcheons are Nickel Plated to Match Stainless Steel.
3. VN escutcheon available only with indicators. Must be ordered with "V" indicator options. See page 56 for more information. Option add also applies.

When Ordering: Specify design, hand and finish.

8800FL SERIES MORTISE LOCKS

LEVER DESIGN: Hampton - HA

ROSE DESIGNS: R3, R4, R5, R6, R7, R8, R9
Copenhagen - R

ESCUTCHEON DESIGNS: E3, E4,
Camden - CN, VN²

MODEL #	PRODUCT DESCRIPTION	ROSE TRIM 605 606 619 625 626	ESCUTCHEON TRIM 605 606 619 625 626
SINGLE CYLINDER:			
8805FL	Storeroom or Closet	\$1,204.00	\$1,329.00
8807FL	Entrance		
8808FL	Classroom		
8809FL	Classroom or Office with Thumbturn	\$1,218.00	\$1,343.00
8824FL	Holdback	\$1,204.00	\$1,329.00
8829FL	Closet		
8833FL	Exit		
8834FL	All Purpose		
8864FL ³	Bathroom with Indicator	\$1,409.00	\$1,534.00
SINGLE CYLINDER WITH DEADBOLT:			
8822FL	Dormitory	\$1,231.00	\$1,356.00
8823FL	Storeroom		
8840FL	Storeroom		
8847FL	Entrance or Apartment		
8860FL	Entrance or Storeroom		
8861FL	Dormitory or Storeroom		
8867FL	Dormitory or Exit		
DOUBLE CYLINDER:			
8808-2FL	Classroom	\$1,312.00	\$1,437.00
8817-2FL	Apartment, Exit or Public Toilet		
8830-2FL	Asylum		
8834-2FL	All Purpose		
DOUBLE CYLINDER WITH DEADBOLT:			
8811-2FL	Classroom Deadbolt	\$1,339.00	\$1,464.00
8812-2FL	Classroom Security		
8818-2FL	Classroom Security Intruder		
8860-2FL	Entrance or Storeroom		
HOTEL/MOTEL:			
8820FL ^{1,3}	Hotel/Motel	\$1,358.00	\$1,483.00
8827FL ^{1,3}	Hotel/Motel		
8832FL	Hotel/Motel	\$1,330.00	\$1,455.00
NON-KEYED:			
8801FL	Passage	\$1,075.00	\$1,200.00
8802FL	Privacy	\$1,123.00	\$1,248.00
8828FL	Exit	\$1,075.00	\$1,200.00
8835FL	Exit with Thumbturn	\$1,116.00	\$1,241.00
8862FL	Bathroom	\$1,096.00	\$1,221.00
8865FL	Bathroom with Thumbturn	\$1,110.00	\$1,235.00
8866FL	Passage Lock w/ Indicator (VXX option add pg 56 also applies)	\$1,096.00	\$1,221.00
DUMMY TRIM:			
855FL	Single	\$480.50	\$543.00
838AFL	Pair	\$961.00	\$1,086.00
838BFL	Pair (Strike available upon request)	\$993.00	\$1,118.00
8870FLDT	Plain	\$1,075.00	\$1,200.00
8871FLDT	Latchbolt		
8872FLDT	Latchbolt x Deadbolt		

1. Price Includes Hotel Indicator.

2. VN escutcheon available only with indicators. Must be ordered with "V" indicator options. See page 56 for more information.
Option add also applies.

3. Not available with R9 rose.

When Ordering: Specify design, function, hand finish and trim.

8800 SERIES MORTISE LOCKS

KNOB DESIGN: Copenhagen - CO

ROSE DESIGNS: Copenhagen - R
R3, R4, R5, R6, R7, R8, R9

MODEL #	PRODUCT DESCRIPTION	613E 626 BSP WSP	605 606 611 612 618 619 625 629 ³ 630 ³ 693
SINGLE CYLINDER:			
8805	Storeroom or Closet	\$994.00	\$1,018.00
8807	Entrance		
8808	Classroom		
8809	Classroom or Office with Thumbturn	\$1,008.00	\$1,032.00
8824	Holdback	\$994.00	\$1,018.00
8829	Closet		
8833	Exit		
8834	All Purpose		
8864 ⁴	Bathroom with Indicator	\$1,199.00	\$1,223.00
SINGLE CYLINDER WITH DEADBOLT:			
8822	Dormitory	\$1,021.00	\$1,045.00
8823	Storeroom		
8831 ²	Detention	\$1,147.00	\$1,171.00
8840	Storeroom	\$1,021.00	\$1,045.00
8847	Entrance or Apartment		
8860	Entrance or Storeroom		
8861	Dormitory or Storeroom		
8867	Dormitory or Exit		
DOUBLE CYLINDER:			
8808-2	Classroom	\$1,102.00	\$1,126.00
8817-2	Apartment, Exit or Public Toilet		
8830-2	Asylum		
8834-2	All Purpose		
DOUBLE CYLINDER WITH DEADBOLT:			
8811-2	Classroom Deadbolt	\$1,129.00	\$1,153.00
8812-2	Classroom Security		
8818-2	Classroom Security Intruder		
8860-2	Entrance or Storeroom		
HOTEL/MOTEL:			
8820 ^{1,4}	Hotel/Motel	\$1,148.00	\$1,172.00
8827 ^{1,4}	Hotel/Motel		
8832	Hotel/Motel	\$1,120.00	\$1,144.00
NON-KEYED:			
8801	Passage	\$865.00	\$889.00
8802	Privacy	\$913.00	\$937.00
8828	Exit	\$865.00	\$889.00
8835	Exit with Thumbturn	\$906.00	\$930.00
8862	Bathroom	\$886.00	\$910.00
8865	Bathroom with Thumbturn	\$900.00	\$924.00
8866	Passage Lock w/ Indicator (VXX option add pg 56 also applies)	\$886.00	\$910.00
DUMMY TRIM:			
855	Single	\$375.50	\$387.50
836A	Pair	\$751.00	\$775.00
836B	Pair (Strike available upon request)	\$783.00	\$807.00
8870DT	Plain	\$865.00	\$889.00
8871DT	Latchbolt		
8872DT	Latchbolt x Deadbolt		

1. Price Includes Hotel Indicator.
2. Price Includes Heat-Treated Base and Torx®.
3. Knobs are Nickel Plated to Match Stainless Steel.
4. Not available with R9 rose.

When Ordering: Specify design, hand and finish.

8800 SERIES MORTISE LOCKS

KNOB DESIGN: Copenhagen - CO

ESCUTCHEON DESIGNS: Camden - CN
E3, E4, VN⁴

MODEL #	PRODUCT DESCRIPTION	613E 626 BSP WSP	605 606 611 612 618 619 625 629 ³ 630 ³ 693
SINGLE CYLINDER:			
8805	Storeroom or Closet	\$1,016.00	\$1,040.00
8807	Entrance		
8808	Classroom		
8809	Classroom or Office with Thumbturn	\$1,030.00	\$1,054.00
8824	Holdback	\$1,016.00	\$1,040.00
8829	Closet		
8833	Exit		
8834	All Purpose		
8864	Bathroom with Indicator	\$1,221.00	\$1,245.00
SINGLE CYLINDER WITH DEADBOLT:			
8822	Dormitory	\$1,043.00	\$1,067.00
8823	Storeroom		
8831 ²	Detention	\$1,169.00	\$1,193.00
8840	Storeroom	\$1,043.00	\$1,067.00
8847	Entrance or Apartment		
8860	Entrance or Storeroom		
8861	Dormitory or Storeroom		
8867	Dormitory or Exit		
DOUBLE CYLINDER:			
8808-2	Classroom	\$1,124.00	\$1,148.00
8817-2	Apartment, Exit or Public Toilet		
8830-2	Asylum		
8834-2	All Purpose		
DOUBLE CYLINDER WITH DEADBOLT:			
8811-2	Classroom Deadbolt	\$1,151.00	\$1,175.00
8812-2	Classroom Security		
8818-2	Classroom Security Intruder		
8860-2	Entrance or Storeroom		
HOTEL/MOTEL:			
8820 ¹	Hotel/Motel	\$1,170.00	\$1,194.00
8827 ¹	Hotel/Motel		
8832	Hotel/Motel	\$1,142.00	\$1,166.00
NON-KEYED:			
8801	Passage	\$887.00	\$911.00
8802	Privacy	\$935.00	\$959.00
8828	Exit	\$887.00	\$911.00
8835	Exit with Thumbturn	\$928.00	\$952.00
8862	Bathroom	\$908.00	\$932.00
8865	Bathroom with Thumbturn	\$922.00	\$946.00
8866	Passage Lock w/ Indicator (VXX option add pg 56 also applies)	\$908.00	\$932.00
DUMMY TRIM:			
855	Single	\$386.50	\$398.50
836A	Pair	\$773.00	\$797.00
836B	Pair (Strike available upon request)	\$805.00	\$829.00
8870DT	Plain	\$887.00	\$911.00
8871DT	Latchbolt		
8872DT	Latchbolt x Deadbolt		

1. Price Includes Hotel Indicator.
2. Price Includes Heat Treated Base and TORX®.
3. Knobs and Escutcheons are Nickel Plated to match Stainless Steel.
4. VN escutcheon available only with indicators. Must be ordered with "V" indicator options. See page 56 for more information.
Option add also applies.

When Ordering: Specify design, hand and finish.

8800FL SERIES MORTISE DEADLOCKS WITH A/F, CYLINDERS & THUMBTURNS

MODEL #	PRODUCT DESCRIPTION	ALL FINISHES
DEADLOCKS:		
8813ST	Single Cylinder with Thumbturn	\$561.00
8813ST-2	Double Cylinder with Thumbturn	\$669.00
8814	Single Cylinder	\$495.00
8814-2	Double Cylinder	\$603.00
8815	Single Cylinder with Thumbturn	\$561.00
8833-2	Double Cylinder	\$603.00

Note: Add \$22.00 for CN Escutcheon Trim. Not available with E3, E4 escutcheons.

When Ordering: Specify design, hand and finish.

8800 SERIES MORTISE LOCK COMPONENTS

Refer to the 8800 Series catalog for information on function availability.

INDICATOR OPTIONS:

DESCRIPTION	SPECIFY OPTION CODE	OPTION ADD
Single Indicator Outside - Unlocked/Locked - Green/Red	V10	Add \$175.00 per lockset
Single Indicator Outside - Vacant/Occupied - Green/Red	V20	
Single Indicator Outside - Icons Only - Green/Red	V30	
Single Indicator Outside - Unlocked/Locked - White/Red	V40	
Single Indicator Outside - Vacant/Occupied - White/Red	V50	
Single Indicator Outside - Icons Only - White/Red	V60	
Single Indicator Inside - Unlocked/Locked - Green/Red	V01	
Single Indicator Inside - Icons Only - Green/Red	V03	
Single Indicator Inside - Unlocked/Locked - White/Red	V04	
Single Indicator Inside - Icons Only - White/Red	V06	
Double Indicator - Unlocked/Locked - Green/Red (Outside) Unlocked/Locked - Green/Red (Inside)	V11	Add \$350.00 per lockset
Double Indicator - Vacant/Occupied - Green/Red (Outside) Unlocked/Locked - Green/Red (Inside)	V21	
Double Indicator - Icons Only - Green/Red (Outside) Icons Only - Green/Red (Inside)	V33	
Double Indicator - Unlocked/Locked - White/Red (Outside) Unlocked/Locked - White/Red (Inside)	V44	
Double Indicator - Vacant/Occupied - White/Red (Outside) Unlocked/Locked - White/Red (Inside)	V54	
Double Indicator - Icons Only - White/Red (Outside) Icons Only - White/Red (Inside)	V66	
Privacy Indicator - Single Indicator Outside, 8802, 8862 functions only - Green/Red Icons	IND	Add \$191.00 per lockset
Cylinder Indicator - Single Indicator Outside, 8818-2, 8822, 8832 functions only - Green/Red Icons (not available with R3, R4, R5 or R9 rose)	CIND	
Outside Engraving with "Lock" and Directional Arrow (Specify Handing)	EMA	Add \$64.00 per lockset
Inside Engraving with "Lock" and Directional Arrow (Specify Handing)	EMB	
Engraving Both Sides with "Lock" and Directional Arrow (Specify Handing)	EMC	Add \$128.00 per lockset

FRENCH OPTIONS FOR V SERIES INDICATORS:

DESCRIPTION	SPECIFY OPTION CODE	OPTION ADD
Single Indicator Outside - Ouvert/Fermé - Green/Red	V10F	Add \$175.00 per lockset
Single Indicator Outside - Libre/Occupée - Green/Red	V20F	
Single Indicator Inside - Ouvert/Fermé - Green/Red	V01F	
Double Indicator - Ouvert/Fermé - Green/Red (outside) Ouvert/Fermé - Green/Red (inside)	V11F	Add \$350.00 per lockset
Double Indicator - Ouvert/Fermé - Green/Red (outside) Libre/Occupée - Green/Red (inside)	V21F	

SECTIONAL TRIM RETROFIT KITS FOR V SERIES INDICATORS:

DESCRIPTION	MODEL #	LIST PRICE
Keyed Functions	YA190, YA191, YA192	\$286.00
Cointurn for Emergency Override	YA193	
Thumbturn	YA194, YA196, YA198	
No Input - Blank	YA197	

NOTES:

When ordering sectional trim retrofit kits, specify finish, hand and V code required. i.e. YA190 x RH x 626 x V01. Kits accommodate indicators on one side of the door only. If indicators are required for both sides, 2 kits must be ordered as required by function. For escutcheon retrofit kits, specify TP(function), trim, hand, finish and V code required. See page 58 for pricing, add for indicator also applies.

SECTIONAL TRIM RETROFIT KITS FOR IND/CIND INDICATORS:

MODEL #	DESCRIPTION	LIST PRICE
IND-K	Retrofit Kit Used with Sectional Trim Only for 8802(FL) and 8862(FL). Specify Finish.	\$191.00
CIND-K	Retrofit Kit Used with Sectional Trim Only for 8818-2(FL), 8822(FL) and 8832(FL). Specify Finish. Not available for use with R3, R4, R5, or R9 roses.	

See page 59 for indicator escutcheons only.

MORTISE LOCK BODIES (WITH ARMOR FRONT AND STRIKE)

FUNCTION	LOCKBODY MODEL #	LIST PRICE
LEVERS:		
8801FL	LBDY8801FL	\$509.00
8802FL	LBDY8802FL	\$644.00
8805FL	LBDY8805FL	\$588.00
8807FL	LBDY8807FL	
8808FL	LBDY8808FL	
8809FL	LBDY8809FL	
8864FL	LBDY8864FL	
8808-2FL	LBDY8808FL	
8811-2FL	LBDY8811FL	\$644.00
8812-2FL	LBDY8812FL	\$588.00
8817-2FL	LBDY8817FL	
8818-2FL	LBDY8818FL	\$644.00
8820FL	LBDY8820FL	
8822FL	LBDY8822FL	
8823FL	LBDY8823FL	
8824FL	LBDY8824FL	
8827FL	LBDY8827FL	
8832FL	LBDY8832FL	
8835FL	LBDY8835FL	
8840FL	LBDY8840FL	
8847FL	LBDY8847FL	
8828FL	LBDY8828FL	\$513.00
8829FL	LBDY8829FL	\$588.00
8830-2FL	LBDY8830FL	\$628.00
8833FL	LBDY8833FL	\$588.00
8833-2FL	LBDY8833FL	
8834FL	LBDY8834FL	
8834-2FL	LBDY8834FL	\$628.00
8860FL	LBDY8860FL	
8860-2FL	LBDY8860FL	
8861FL	LBDY8861FL	\$588.00
8862FL	LBDY8862FL	
8865FL	LBDY8865FL	\$588.00
8866FL	LBDY8866FL	
8867FL	LBDY8867FL	\$628.00

FUNCTION	LOCKBODY MODEL #	LIST PRICE
KNOBS:		
8801	LBDY8801	\$509.00
8802	LBDY8802	\$644.00
8805	LBDY8805	\$588.00
8807	LBDY8807	
8808	LBDY8808	
8809	LBDY8809	
8864	LBDY8864	
8808-2	LBDY8808	
8811-2	LBDY8811	\$644.00
8812-2	LBDY8812	\$588.00
8817-2	LBDY8817	
8818-2	LBDY8818	\$644.00
8820	LBDY8820	
8822	LBDY8822	
8823	LBDY8823	
8824	LBDY8824	
8827	LBDY8827	
8832	LBDY8832	
8835	LBDY8835	
8840	LBDY8840	
8847	LBDY8847	
8828	LBDY8828	\$513.00
8829	LBDY8829	\$588.00
8830-2	LBDY8830	\$628.00
8831	LBDY8831	\$588.00
8833	LBDY8833	
8833-2	LBDY8833	
8834	LBDY8834	\$628.00
8834-2	LBDY8834	
8860	LBDY8860	
8860-2	LBDY8860	\$588.00
8861	LBDY8861	
8862	LBDY8862	\$588.00
8865	LBDY8865	
8866	LBDY8866	\$628.00
8867	LBDY8867	\$628.00

NOTE: Trim priced separately.
 Armor Fronts and Strikes included with lockbodies only. Finish must be specified.
 Cylinders are not furnished with lock bodies; cylinders must be ordered separately.

PART NUMBER	LOCK FUNCTION	ALL FINISHES
ARMOR FRONT & STRIKE PACKS:		
50-0020-8801-FIN	8801, 8862, 8865, 8866	\$85.00
50-0020-8802-FIN	8802, 8811, 8822, 8823, 8860, 8861	
50-0020-8805-FIN	8805, 8808, 8809, 8817, 8828, 8829, 8830, 8833, 8864	
50-0020-8807-FIN	8807	
50-0020-8813-FIN	8813, 8814, 8815	
50-0020-8820-FIN	8812, 8818, 8820, 8831, 8832, 8835	
50-0020-8824-FIN	8824, 8834, 8834-2	
50-0020-8847-FIN	8827, 8847	
50-0020-8867-FIN	8867	

When Ordering: Specify design, hand and finish.

TRIM

PRODUCT CODE	PRODUCT DESCRIPTION	613E 626 BSP WSP	605 606 611 612 618 619 625 629' 630' 693
LEVERS WITH ROSES:			
AUR	Specify "TP" with lock function and finish	\$699.00	\$723.00
CRR	Specify "TP" with lock function and finish		
MOR	Specify "TP" with lock function and finish		
PBR	Specify "TP" with lock function and finish		
ARR	Specify "TP" with lock function and finish	\$866.00	\$890.00
JNR	Specify "TP" with lock function and finish		
PNR	Specify "TP" with lock function and finish		
VIR	Specify "TP" with lock function and finish		
LEVERS WITH ESCUTCHEONS²:			
AUCN or AUVN	Specify "TP" with lock function and finish	\$721.00	\$745.00
CRCN or CRVN	Specify "TP" with lock function and finish		
MOCN or MOVN	Specify "TP" with lock function and finish		
PBCN or PBVN	Specify "TP" with lock function and finish		
ARCN or ARVN	Specify "TP" with lock function and finish	\$888.00	\$912.00
JNCN or JNVN	Specify "TP" with lock function and finish		
PNCN or PNVN	Specify "TP" with lock function and finish		
VICN or VIVN	Specify "TP" with lock function and finish		
KNOB WITH ROSES:			
COR	Specify "TP" with lock function and finish	\$677.00	\$701.00
KNOB WITH ESCUTCHEONS²:			
COCN or COVN	Specify "TP" with lock function and finish	\$699.00	\$723.00

When ordering trim packs, specify desired trim and "TP" x lock function with desired finish. i.e. AUR x TP8801 x 626

1. Levers, Knobs and CN Escutcheons are Nickel Plated to match Stainless Steel.
2. VN escutcheon available only with indicators. Must be ordered with "V" indicator options. See page 56 for more information.
Option add also applies.

When Ordering: Specify finish.

MORTISE LOCK PARTS

MODEL #	PRODUCT DESCRIPTION	613E 626 BSP WSP	605 606 611 612 618 619 625 629' 630' 693
ESCUTCHEON PLATES:			
CN87	Inside	\$149.00	\$153.00
CN88	Outside		

MODEL #	PRODUCT DESCRIPTION	613E 626 BSP WSP	605 606 611 612 618 619 625 629' 630'
ESCUTCHEON PLATES:			
E3-88	Outside	\$354.00	\$378.00
E3-87	Inside		
E4-88	Outside		
E4-87	Inside		

NOTE: When ordering escutcheons separately, specify the model number of the escutcheon plate suffixed with the spacing number. The spacing number indicates the hole preparation in the escutcheon plate to coordinate with the lock functions.

- 211, 251 inside escutcheon include thumbturn
- 211 outside escutcheon includes thumbturn
- 212 outside escutcheon has hole for emergency release tool
- 260, 261, & 262 used with CN escutcheon only. These are an assembly which includes indicator.
- 262 used with CN88 only
- 250, 251, & 252 are not available with E3 or 34 escutcheons

1. CN Escutcheons are Nickel Plated to match Stainless Steel.

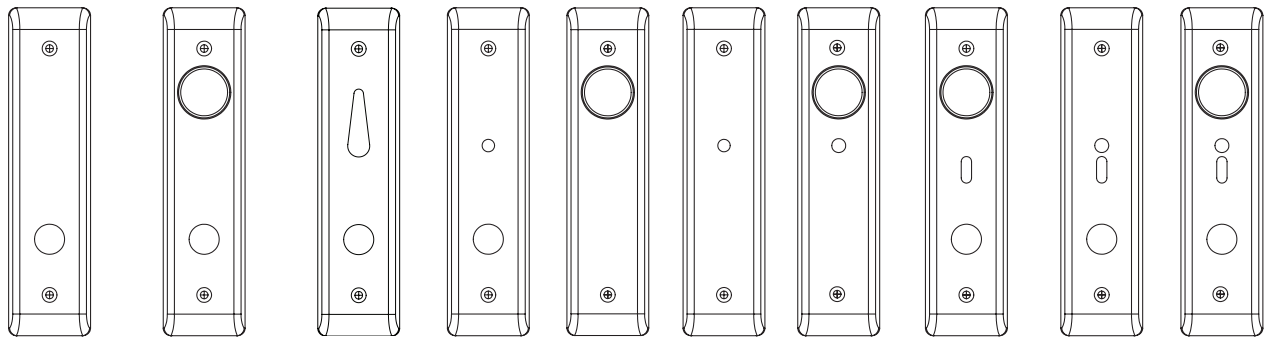

	201	208	211	212	250	251	252	260	261	262
Inside (87)	8801, 8805, 8807, 8808, 8824, 8828, 8833, 8880, 8884, 8890, 8881, 8885, 8895	8808-2, 8811-2, 8812-2, 8817-2, 8818-2, 8830-2, 8831, 8834, 8834-2, 8860-2, 8894-2, 8896-2, 8898-2, 8895-2, 8897-2, 8899-2	8802, 8809, 8820, 8822, 8827, 8832, 8831, 8834, 8835, 8840, 8847, 8860, 8861, 8862, 8864, 8865, 8867		8814-2, 8833-2,	8813ST, 8815,	8813ST-2	8818-2*		
Outside (88)	8801, 8831, 8880, 8884, 8881, 8885	8805, 8807, 8808, 8808-2, 8809, 8811-2, 8812-2, 8817-2, 8818-2, 8822, 8823, 8824, 8829, 8830-2, 8832, 8840, 8847, 8860, 8860-2, 8861, 8867, 8890, 8894-2, 8896, 8896-2, 8898, 8898-2, 8891, 8895-2, 8897, 8897-2, 8899, 8899-2	8865	8802, 8862	8813ST, 8813ST-2, 8814, 8814-2, 8815, 8833, 8833-2, 8834, 8834-2			8818-2*, 8820, 8822*, 8827, 8832*, 8864	8802, 8862	

* Optional indicator escutcheon

When Ordering: Specify finish.

OUTSIDE		INSIDE	613E 626 BSP WSP	605 606 611 612 618 619 625 629' 630' 693
LEVER HANDLES – PAIRS WITH SPINDLES:				
CR904	X	CR905	\$531.00	\$555.00
AU904	X	AU905		
MO904	X	MO905		
PB904	X	PB905		
VI904	X	VI905		
AR902	X	AR903	\$691.00	\$715.00
JN902	X	JN903		
PN904	X	PN905		

1. Levers are Nickel Plated to match Stainless Steel.

OUTSIDE	X	INSIDE	ALL FINISHES
LEVER HANDLES - PAIRS WITH SPINDLES:			
HA904	X	HA905	\$730.00

PRODUCT #	613E 626 BSP WSP	605 606 611 612 618 619 625 629' 630' 693
KNOBS – PAIRS WITH SPINDLES:		
CO35S	\$484.00	\$496.00

1. Knobs are Nickel Plated to match Stainless Steel.

MODEL #	PRODUCT DESCRIPTION	613E 626 BSP WSP	605 606 611 612 618 619 625 629' 630'
ROSE ASSEMBLIES:			
R3-505	Inside	\$112.00	\$136.00
R3-506	Outside		
R4-505	Inside		
R4-506	Outside		
R5-505	Inside		
R5-506	Outside		
R6-505	Inside		
R6-506	Outside		
R7-505	Inside		
R7-506	Outside		
R8-505	Inside		
R8-506	Outside		
R9-505	Inside (Specify Hand)		
R9-506	Outside (Specify Hand)		

PRODUCT #	PRODUCT DESCRIPTION	613E 626 BSP WSP	605 606 611 612 618 619 625 629 630 693
ROSES – EACH:			
CO505	Inside Rose	\$125.00	\$129.00
CO506	Outside Rose		

PRODUCT #	PRODUCT DESCRIPTION	ALL FINISHES
STANDARD THUMBTURN:		
GF1824	Round Plate - with Thumbturn	\$86.00
EMERGENCY KEY PLATES:		
GF1826	Round Plate - Privacy	\$86.00
GF1828	Round Plate - Blank	
THUMBTURN FOR HA LEVER*:		
50-1824-0033	For Rose 1-3/4" Door	\$223.00
SQUARE THUMBTURN & PLATE:		
50-1824-0057	For Rose 1-3/4" Door	\$223.00

When Ordering: Specify finish.

*For escutcheon trim, inside plate must be ordered. See page 59.

MORTISE LOCK PARTS

MODEL #	PRODUCT DESCRIPTION	ALL FINISHES
STRIKES:		
2815	Latchbolt and Deadbolt, Curved Lip (8800)	\$57.00
2816	Latchbolt and Deadbolt, Flat Lip (8800)	
497B	Blank Filler Plate	
718	Open Back Strike (black)	\$234.00
202	Strike Box	\$2.00
81-0071-8612-999	Torx Screw Part Number for Strikes - 2 Required	\$3.00

NOTE: Standard strike pack does not include TORX screws.

PART NUMBER	LOCK FUNCTION	ALL FINISHES
ARMOR FRONTS:		
50-8801-X219	8801, 8862	\$47.00
50-8802-X219	8802, 8811, 8822, 8823, 8860, 8861	
50-8805-X219	8805, 8808, 8809, 8817, 8828, 8829, 8830, 8833, 8864, 8865, 8866	
50-8807-X219	8807	
50-8813-X219	8813, 8814, 8815	
50-8820-X219	8812, 8818, 8820, 8831, 8832, 8835	
50-8824-X219	8824, 8834, 8834-2	
50-8847-X219	8827, 8847	
50-8867-X219	8867	
81-00X2-0404	Armor Front Screw (each)	

For "X" in part number, specify finish required:

- For 605, 606, 611, 612, 613, 618, 619, 625, 626, 693 or 722 substitute "X" with "2"
- For 629 or 630 substitute "X" with "7"

Example = 50-8847-7219 would be used for an 8847 mortise lock in 630 finish.

MODEL #	PRODUCT DESCRIPTION	ALL FINISHES
SPINDLE (PARTS):		
1173L	Straight Spindle 3/8" (P/N varies by door thickness)	\$67.00
1178L	Swivel Spindle 3/8" for Lever x Lever (P/N varies by door thickness)	
F1198	Threaded Hook Spindle 3/8" (P/N 50-1198-0007-48)	
DUMMY SPINDLE (PARTS):		
1424	Dummy Spindle Assembly - Standard Trim (P/N 50-1424-0003-048)	\$57.00
CR814F828	Dummy Spindle Assembly - Reflections® Trim	\$57.00

MODEL #	PRODUCT DESCRIPTION	612 626
RABBETED KITS:		
RK245	Latchbolt & Deadbolt, 1-3/4" & 2" Door	\$339.00
TOOLS:		
S1064	Knob & Rose Wrench	\$4.70
E203	Emergency Key	\$4.10

When Ordering: Specify finish.

STATUS INDICATOR (PARTS)

PART NO.	DESCRIPTION	LIST PRICE
81-0472-4000 x Finish	Sectional Cylinder Plate Only (cylinder not included)	\$124.00
81-0471-4000 x Finish	Sectional Cointurn Plate Only (cointurn not included)	\$123.00
50-8800-0364 x Finish	Sectional Thumbturn Plate Only (assembly includes thumbturn)	\$124.00
81-0473-4000 x Finish	Sectional No Input-Blank Plate Only	
81-0749-9000	Indicator Retaining Pad (sectional)	\$5.00
856F049	Indicator Window	
50-8800-9328	Indicator Spindle Cam - Thumbturn	\$18.00
50-8800-0346	Indicator Spindle Cam - Thumbturn Overtravel	
50-8800-7335	Indicator Spindle Cam - Cylinder / No Input-Blank (1-3/4" door thickness)	
50-8800-7336	Indicator Spindle Cam - Cylinder / No Input-Blank (1-3/8" door thickness)	
50-8800-7337	Indicator Spindle Cam - Cylinder / No Input-Blank (2-1/4" door thickness)	
50-8800-7338	Indicator Spindle Cam - Cylinder / No Input-Blank (door thickness greater than 2-1/4", must specify)	
50-8800-0378	Indicator Spindle Cam - Cylinder Overtravel (1-3/4" door thickness)	
50-8800-0379	Indicator Spindle Cam - Cylinder Overtravel (1-3/8" door thickness)	
50-8800-0380	Indicator Spindle Cam - Cylinder Overtravel (2-1/4" door thickness)	
50-8800-0381	Indicator Spindle Cam - Cylinder Overtravel (door thickness greater than 2-1/4", must specify)	
50-8800-7339 x finish	Indicator Spindle Cam - Cointurn (1-3/4" door thickness)	\$21.00
50-8800-7340 x finish	Indicator Spindle Cam - Cointurn (1-3/8" door thickness)	
50-8800-7341 x finish	Indicator Spindle Cam - Cointurn (2-1/4" door thickness)	
50-8800-7342 x finish	Indicator Spindle Cam - Cointurn (door thickness greater than 2-1/4", must specify)	
82-5602-4000	Indicator Display Assembly - Unlocked/Locked, Green/Red	\$86.00
82-5603-4000	Indicator Display Assembly - Vacant/Occupied, Green/Red	
82-5604-4000	Indicator Display Assembly - Unlocked Icon/Locked Icon, Green/Red	
82-5605-4000	Indicator Display Assembly - Unlocked/Locked, White/Red	
82-5606-4000	Indicator Display Assembly - Vacant/Occupied, White/Red	
82-5607-4000	Indicator Display Assembly - Unlocked Icon/Locked Icon, White/Red	
82-5684-4000	Indicator Display Assembly - Ouvert/Fermé, Green/Red	
82-5685-4000	Indicator Display Assembly - Libre/Occupée, Green/Red	
855F638	VN Escutcheon Indicator Backing Plate	\$5.00
855F658	Sectional Indicator Surface Mount Backing Plate	\$17.00
858F517 x Finish	VN Escutcheon Indicator Screw Pack - Phillips, 1-3/4" Door	\$16.00
858F50M x Finish	VN Escutcheon Indicator Screw Pack - Phillips, 1-3/8" Door	
858F52M x Finish	VN Escutcheon Indicator Screw Pack - Phillips, 2" Door	
858F53M x Finish	VN Escutcheon Indicator Screw Pack - Phillips, 2-1/4" Door	
858F55M x Finish	VN Escutcheon Indicator Screw Pack - Phillips, 2-1/2" Door	
858F497 x Finish	Sectional Indicator Screw Pack - Phillips & Torx, All Doors	
50-8800-9343	Sectional Indicator Template Kit	\$19.00

8800FL SERIES ELECTRIFIED MORTISE LOCKS

LEVER DESIGNS: Augusta - AU
Monroe - MO

Pacific Beach - PB
Carmel - CR

ROSE DESIGNS: Copenhagen - R
R3, R4, R5, R6, R7, R8, R9

MODEL #	PRODUCT DESCRIPTION	613E 626 BSP WSP	605 606 611 612 618 619 625 629 ¹ 630 ¹ 693
SINGLE CYLINDER:			
8890FL	Fail Safe	\$1,377.00	\$1,401.00
8891FL	Fail Secure		
SINGLE CYLINDER WITH DEADBOLT:			
8896FL	Fail Safe	\$1,404.00	\$1,428.00
8897FL	Fail Secure		
8898FL	Fail Safe		
8899FL	Fail Secure		
DOUBLE CYLINDER:			
8894-2FL	Fail Safe	\$1,485.00	\$1,509.00
8895-2FL	Fail Secure		
DOUBLE CYLINDER WITH DEADBOLT:			
8896-2FL	Fail Safe	\$1,512.00	\$1,536.00
8897-2FL	Fail Secure		
8898-2FL	Fail Safe		
8899-2FL	Fail Secure		
NO CYLINDER OVERRIDE:			
8880FL	Fail Safe	\$1,269.00	\$1,293.00
8881FL	Fail Secure		
8884FL	Fail Safe		
8885FL	Fail Secure		

LEVER DESIGNS: Augusta - AU
Monroe - MO

Pacific Beach - PB
Carmel - CR

ESCUTCHEON DESIGNS: Camden - CN
E3, E4

MODEL #	PRODUCT DESCRIPTION	613E 626 BSP WSP	605 606 611 612 618 619 625 629 ¹ 630 ¹ 693
SINGLE CYLINDER:			
8890FL	Fail Safe	\$1,399.00	\$1,423.00
8891FL	Fail Secure		
SINGLE CYLINDER WITH DEADBOLT:			
8896FL	Fail Safe	\$1,426.00	\$1,450.00
8897FL	Fail Secure		
8898FL	Fail Safe		
8899FL	Fail Secure		
DOUBLE CYLINDER:			
8894-2FL	Fail Safe	\$1,507.00	\$1,531.00
8895-2FL	Fail Secure		
DOUBLE CYLINDER WITH DEADBOLT:			
8896-2FL	Fail Safe	\$1,534.00	\$1,558.00
8897-2FL	Fail Secure		
8898-2FL	Fail Safe		
8899-2FL	Fail Secure		
NO CYLINDER OVERRIDE:			
8880FL	Fail Safe	\$1,291.00	\$1,315.00
8881FL	Fail Secure		
8884FL	Fail Safe		
8885FL	Fail Secure		

1. Levers and Escutcheons are Nickel Plated to match Stainless Steel.

When Ordering: Specify design, hand and finish.

8800FL SERIES ELECTRIFIED MORTISE LOCKS

LEVER DESIGNS: Arcadia - AR
Jefferson - JN

Pinehurst - PN
Virginia - VI

ROSE DESIGNS: Copenhagen - R
R3, R4, R5, R6, R7, R8, R9

MODEL #	PRODUCT DESCRIPTION	613E 626 BSP WSP	605 606 611 612 618 619 625 629 ¹ 630 ¹ 693
SINGLE CYLINDER:			
8890FL	Fail Safe	\$1,544.00	\$1,568.00
8891FL	Fail Secure		
SINGLE CYLINDER WITH DEADBOLT:			
8896FL	Fail Safe	\$1,571.00	\$1,595.00
8897FL	Fail Secure		
8898FL	Fail Safe		
8899FL	Fail Secure		
DOUBLE CYLINDER:			
8894-2FL	Fail Safe	\$1,652.00	\$1,676.00
8895-2FL	Fail Secure		
DOUBLE CYLINDER WITH DEADBOLT:			
8896-2FL	Fail Safe	\$1,679.00	\$1,703.00
8897-2FL	Fail Secure		
8898-2FL	Fail Safe		
8899-2FL	Fail Secure		
NO CYLINDER OVERRIDE:			
8880FL	Fail Safe	\$1,436.00	\$1,460.00
8881FL	Fail Secure		
8884FL	Fail Safe		
8885FL	Fail Secure		

LEVER DESIGNS: Arcadia - AR
Jefferson - JN

Pinehurst - PN
Virginia - VI

ESCUTCHEON DESIGNS: Camden - CN
E3, E4

MODEL #	PRODUCT DESCRIPTION	613E 626 BSP WSP	605 606 611 612 618 619 625 629 ¹ 630 ¹ 693
SINGLE CYLINDER:			
8890FL	Fail Safe	\$1,566.00	\$1,590.00
8891FL	Fail Secure		
SINGLE CYLINDER WITH DEADBOLT:			
8896FL	Fail Safe	\$1,593.00	\$1,617.00
8897FL	Fail Secure		
8898FL	Fail Safe		
8899FL	Fail Secure		
DOUBLE CYLINDER:			
8894-2FL	Fail Safe	\$1,674.00	\$1,698.00
8895-2FL	Fail Secure		
DOUBLE CYLINDER WITH DEADBOLT:			
8896-2FL	Fail Safe	\$1,701.00	\$1,725.00
8897-2FL	Fail Secure		
8898-2FL	Fail Safe		
8899-2FL	Fail Secure		
NO CYLINDER OVERRIDE:			
8880FL	Fail Safe	\$1,458.00	\$1,482.00
8881FL	Fail Secure		
8884FL	Fail Safe		
8885FL	Fail Secure		

1. Levers and Escutcheons are Nickel Plated to match Stainless Steel.

When Ordering: Specify design, hand and finish.

8800FL SERIES ELECTRIFIED MORTISE LOCKS

LEVER DESIGN: Hampton - HA

ROSE DESIGNS: R3, R4, R5, R6, R7, R8, R9
Copenhagen - R

ESCUTCHEON DESIGNS: E3, E4,
Camden - CN

MODEL #	PRODUCT DESCRIPTION	ROSE TRIM 605 606 619 625 626	ESCUTCHEON TRIM 605 606 619 625 626
SINGLE CYLINDER:			
8890FL	Fail Safe	\$1,544.00	\$1,669.00
8891FL	Fail Secure		
SINGLE CYLINDER WITH DEADBOLT:			
8896FL	Fail Safe	\$1,571.00	\$1,683.00
8897FL	Fail Secure		
8898FL	Fail Safe		
8899FL	Fail Secure		
DOUBLE CYLINDER:			
8894-2FL	Fail Safe	\$1,652.00	\$1,874.00
8895-2FL	Fail Secure		
DOUBLE CYLINDER WITH DEADBOLT:			
8896-2FL	Fail Safe	\$1,679.00	\$1,696.00
8897-2FL	Fail Secure		
8898-2FL	Fail Safe		
8899-2FL	Fail Secure		
NO CYLINDER OVERRIDE:			
8880FL	Fail Safe	\$1,436.00	\$1,561.00
8881FL	Fail Secure		
8884FL	Fail Safe		
8885FL	Fail Secure		

When Ordering: Specify design, hand and finish.

ELECTRIFIED MORTISE LOCK BODIES (WITH ARMOR FRONT AND STRIKE)

FUNCTION	LOCKBODY MODEL #	DESCRIPTION	LIST PRICE
LEVERS:			
8880FL	LBDY8880FL	Fail Safe	\$928.00
8881FL	LBDY8881FL	Fail Secure	
8884FL	LBDY8884FL	Fail Safe	
8885FL	LBDY8885FL	Fail Secure	
8890FL	LBDY8890FL	Fail Safe	
8891FL	LBDY8891FL	Fail Secure	
8894-2FL	LBDY8894FL	Fail Safe	
8895-2FL	LBDY8895FL	Fail Secure	
8896FL	LBDY8896FL	Fail Safe	\$984.00
8896-2FL	LBDY8896FL	Fail Safe	
8897FL	LBDY8897FL	Fail Secure	
8897-2FL	LBDY8897FL	Fail Secure	
8898FL	LBDY8898FL	Fail Safe	
8898-2FL	LBDY8898FL	Fail Safe	
8899FL	LBDY8899FL	Fail Secure	
8899-2FL	LBDY8899FL	Fail Secure	

NOTE: Includes armor front and strike, finish must be specified.

ELECTRIFIED AND MECHANICAL OPTIONS:		
LBM: SPDT switch that monitors full retraction of latchbolt (available option for electrified functions only)	ADD	\$334.00
DBM: SPDT switch that monitors full retraction of deadbolt		\$307.00
REX: SPDT switch that monitors activation of free lever		\$850.00
MELR: Motorized Electric Latch Retraction (available option for the following functions with lever trim: 8801FL, 8805FL, 8830-2FL)		

See page 208 for power supplies and electrified accessories.

PART NUMBER	LOCK FUNCTION	ALL FINISHES
ARMOR FRONT & STRIKE PACKS:		
50-0020-8805-FIN	8880, 8881, 8884, 8885, 8890, 8891, 8892, 8893, 8894, 8894-2, 8895, 8895-2	\$85.00
50-0020-8820-FIN	8896, 8896-2, 8897, 8897-2, 8898, 8898-2, 8899, 8899-2	

NOTE: Trim priced separately.
Armor Fronts and Strikes included with lockbodies only. Finish must be specified.
Cylinders are not furnished with lock bodies; cylinders must be ordered separately.

When Ordering: Specify design, hand and finish.

SL8800FL SERIES SECURITY MORTISE LOCKS

DESIGNS: Arcadia - ARSL Augusta - AUSL Carmel - CRSL Jefferson - JNSL
 Monroe - MOSL Pacific Beach - PBSL Virginia - VISL

MODEL #	PRODUCT DESCRIPTION	630 ²
SINGLE CYLINDER:		
SL8805FL	Storeroom or Closet	\$1,362.00
SL8807FL	Entrance	
SL8808FL	Classroom	
SL8809FL	Classroom or Office with Thumbturn	\$1,376.00
SL8829FL	Closet	\$1,362.00
SL8831FL	Detention	\$1,488.00
SL8833FL	Exit	\$1,362.00
SINGLE CYLINDER WITH DEADBOLT:		
SL8822FL	Dormitory	\$1,389.00
SL8823FL	Storeroom	
SL8840FL	Storeroom	
SL8847FL	Entrance or Apartment	
SL8860FL	Entrance or Storeroom	
SL8861FL	Dormitory or Storeroom	
SL8867FL	Dormitory or Exit	
DOUBLE CYLINDER:		
SL8808-2FL	Classroom	\$1,470.00
SL8817-2FL	Apartment, Exit or Public Toilet	
SL8830-2FL	Asylum	
DOUBLE CYLINDER WITH DEADBOLT:		
SL8811-2FL	Classroom Deadbolt	\$1,497.00
SL8812-2FL	Classroom Security	
SL8818-2FL	Classroom Security Intruder	
SL8860-2FL	Entrance or Storeroom	
HOTEL/MOTEL:		
SL8820FL ¹	Hotel/Motel	\$1,516.00
SL8827FL ¹	Hotel/Motel	\$1,488.00
SL8832FL	Hotel/Motel	
NON-KEYED:		
SL8801FL	Passage	\$1,233.00
SL8802FL	Privacy	\$1,281.00
SL8828FL	Exit	\$1,233.00
SL8835FL	Exit with Thumbturn	\$1,274.00
SL8862FL	Bathroom	\$1,254.00
SL8865FL	Bathroom with Thumbturn	\$1,268.00

Security Locks are 50% off list only unless special factory quotation allowed.

1. Price Includes Hotel Indicator.
2. Levers are Nickel Plated to match Stainless Steel.

When Ordering: Specify design, function and hand.

SL8800FL SERIES SECURITY LOCK PARTS

MODEL #	PRODUCT DESCRIPTION	630
LEVER HANDLE WITH SPINDLE (two required per lock):		
ARSL904 (specify hand)		\$410.00
AUSL904		
CRSL904		
JNSL904		
MOSL904		
PBSL904		
VISL904		
ESCUTCHEON PLATES:		
SL87 I/S		\$187.00
SL88 O/S		

FUNCTION	LOCKBODY MODEL #	630
MORTISE LOCK BODIES (WITH ARMOR FRONT & STRIKE):		
SL8801FL	LBDYSL8801	\$568.00
SL8802FL	LBDYSL8802	\$743.00
SL8805FL	LBDYSL8805	\$690.00
SL8807FL	LBDYSL8807	
SL8808FL	LBDYSL8808	
SL8809FL	LBDYSL8809	
SL8820FL	LBDYSL8820	
SL8822FL	LBDYSL8822	\$743.00
SL8823FL	LBDYSL8823	
SL8827FL	LBDYSL8827	
SL8832FL	LBDYSL8832	
SL8835FL	LBDYSL8835	
SL8840FL	LBDYSL8840	
SL8847FL	LBDYSL8847	\$577.00
SL8828FL	LBDYSL8828	
SL8829FL	LBDYSL8829	\$690.00
SL8831FL	LBDYSL8831	\$743.00
SL8860FL	LBDYSL8860	
SL8861FL	LBDYSL8861	
SL8862FL	LBDYSL8862	
SL8865FL	LBDYSL8865	
SL8867FL	LBDYSL8867	
SL8808-2FL	LBDYSL8808	
SL8811-2FL	LBDYSL8811	\$690.00
SL8812-2FL	LBDYSL8812	\$743.00
SL8817-2FL	LBDYSL8817	\$690.00
SL8818-2FL	LBDYSL8818	\$743.00
SL8830-2FL	LBDYSL8830	\$690.00
SL8860-2FL	LBDYSL8860	\$743.00

NOTE: Cylinders are not furnished with lock bodies. Cylinder must be ordered separately.

NOTE: When ordering escutcheons separately, specify the model number of the escutcheon plate suffixed with the spacing number. The spacing number indicates the hole preparation in the escutcheon plate to coordinate with the lock functions. See page 59 for spacing numbers.

When Ordering: Specify design, function and hand.

STANDARD FINISHES: Product will be furnished only in the finishes in which it is priced.

ANSI/BHMA CODE	FINISH DESCRIPTION
BRASS:	
605	Bright Brass, Clear Coated
606	Satin Brass, Clear Coated
BRONZE:	
611	Bright Bronze, Clear Coated
612	Satin Bronze, Clear Coated
613E	Dark Oxidized Satin Bronze - equivalent
CHROME:	
625	Bright Chrome Plated
626	Satin Chrome Plated

ANSI/BHMA CODE	FINISH DESCRIPTION
NICKEL:	
618	Bright Nickel Plated, Clear Coated
619	Satin Nickel Plated, Clear Coated
STAINLESS STEEL:	
629	Bright Stainless Steel
630	Satin Stainless Steel
PAINTED:	
BSP	Black Suede Powder Coat
WSP	White Suede Powder Coat

PRODUCT DESCRIPTION	DEDUCT	ADD
LESS CYLINDER: (Specify "x LC") Cylinder rings/collars not furnished with locksets ordered less cylinders.	\$108.00	—
IC Housing ordered with locksets	—	\$0.00
7-PIN CYLINDERS:		
Add to 6-Pin cylinder	—	\$2.00
INTERCHANGEABLE CORE CYLINDERS:		
2196 - LFIC 6-Pin (Includes MK or GMK) Ordering Example: TBR3-8807FL x 2196 x RH x 605	—	\$86.00
2196H - LFIC Hotel Lock (Includes MK or GMK and EMK)	—	\$210.00
A620 - SFIC 6-or 7-Pin (Includes MK or GMK) Ordering Example: TBR3-8807 x A620 x RH x 626	—	\$76.00
SPECIAL STRIKES:		
Strikes with lip lengths other than 1-1/8" or 1-1/4"	—	\$19.00
DOORS 1-7/8" THICK TO 3-1/4" THICK:		
Non-keyed	—	\$158.00
Single cylinder keyed	—	\$250.00
Double cylinder keyed	—	\$280.00
MICROSHIELD®: Antimicrobial coating. Specify option "YMS".	—	\$101.00
KNURLING: Not available	--	--
INDICATORS	See Page 56	
REFLECTIONS LEVERS: The following levers are no longer available in 629 and 630 finishes, CH, DW, TT, TU, TW, TX, TY, UX, TG, TJ, TK, TE, TI and TD.	—	—

8800RL SERIES MORTISE LOCKS

LEVER DESIGNS: All Reflections® Series

ROSE DESIGNS: R3, R4, R5, R6, R7, R8, R9
Copenhagen - R

MODEL #	PRODUCT DESCRIPTION	613E 626 BSP WSP	605 606 611 612 618 619 625 629 ² 630 ²
SINGLE CYLINDER:			
8805RL	Storeroom or Closet	\$1,204.00	\$1,228.00
8807RL	Entrance		
8808RL	Classroom		
8809RL	Classroom or Office with Thumbturn	\$1,218.00	\$1,242.00
8824RL	Hold Back	\$1,204.00	\$1,228.00
8829RL	Closet		
8833RL	Exit		
8834RL	All Purpose		
8864RL ³	Bathroom with Indicator		
SINGLE CYLINDER WITH DEADBOLT:			
8822RL	Dormitory	\$1,231.00	\$1,255.00
8823RL	Storeroom		
8840RL	Storeroom		
8847RL	Entrance or Apartment		
8860RL	Entrance or Storeroom		
8861RL	Dormitory or Storeroom		
8867RL	Dormitory or Exit		
DOUBLE CYLINDER:			
8808-2RL	Classroom	\$1,312.00	\$1,336.00
8817-2RL	Apartment, Exit or Public Toilet		
8830-2RL	Asylum		
8834-2RL	All Purpose		
DOUBLE CYLINDER WITH DEADBOLT:			
8811-2RL	Classroom Deadbolt	\$1,339.00	\$1,363.00
8812-2RL	Classroom Security		
8818-2RL	Classroom Security Intruder		
8860-2RL	Entrance or Storeroom		
HOTEL/MOTEL:			
8820RL ^{1,3}	Hotel/Motel	\$1,358.00	\$1,382.00
8827RL ^{1,3}	Hotel/Motel		
8832RL	Hotel/Motel	\$1,330.00	\$1,354.00
NON-KEYED:			
8801RL	Passage	\$1,075.00	\$1,099.00
8802RL	Privacy	\$1,123.00	\$1,147.00
8828RL	Exit	\$1,075.00	\$1,099.00
8835RL	Exit with Thumbturn	\$1,116.00	\$1,140.00
8862RL	Bathroom	\$1,096.00	\$1,120.00
8865RL	Bathroom with Thumbturn	\$1,110.00	\$1,134.00
8866RL	Passage Lock w/ Indicator (VXX option add pg 56 also applies)	\$1,096.00	\$1,120.00
DUMMY TRIM:			
855RL	Single	\$480.50	\$492.50
838ARL	Pair	\$961.00	\$985.00
838BRL	Pair (Strike available upon request)	\$993.00	\$1,017.00
8870RLDT	Plain	\$1,075.00	\$1,099.00
8871RLDT	Latchbolt		
8872RLDT	Latchbolt x Deadbolt		

1. Price includes Hotel indicator.
2. See the Variations page for details.
3. Not available with R9 rose.

8800RL SERIES MORTISE LOCKS

LEVER DESIGNS: All Reflections® Series

ESCUTCHEON DESIGNS: E3, E4, CN, VN³

MODEL #	PRODUCT DESCRIPTION	613E 626 BSP WSP	605 606 611 612 618 619 625 629 ² 630 ²
SINGLE CYLINDER:			
8805RL	Storeroom or Closet		
8807RL	Entrance	\$1,226.00	\$1,250.00
8808RL	Classroom		
8809RL	Classroom or Office with Thumbturn	\$1,240.00	\$1,264.00
8824RL	Hold Back		
8829RL	Closet		
8833RL	Exit	\$1,226.00	\$1,250.00
8834RL	All Purpose		
8864RL	Bathroom with Indicator	\$1,431.00	\$1,455.00
SINGLE CYLINDER WITH DEADBOLT:			
8822RL	Dormitory		
8823RL	Storeroom		
8840RL	Storeroom		
8847RL	Entrance or Apartment	\$1,253.00	\$1,277.00
8860RL	Entrance or Storeroom		
8861RL	Dormitory or Storeroom		
8867RL	Dormitory or Exit		
DOUBLE CYLINDER:			
8808-2RL	Classroom		
8817-2RL	Apartment, Exit or Public Toilet	\$1,334.00	\$1,358.00
8830-2RL	Asylum		
8834-2RL	All Purpose		
DOUBLE CYLINDER WITH DEADBOLT:			
8811-2RL	Classroom Deadbolt		
8812-2RL	Classroom Security	\$1,361.00	\$1,385.00
8818-2RL	Classroom Security Intruder		
8860-2RL	Entrance or Storeroom		
HOTEL/MOTEL:			
8820RL ¹	Hotel/Motel	\$1,380.00	\$1,404.00
8827RL ¹	Hotel/Motel		
8832RL	Hotel/Motel	\$1,352.00	\$1,376.00
NON-KEYED:			
8801RL	Passage	\$1,097.00	\$1,121.00
8802RL	Privacy	\$1,145.00	\$1,169.00
8828RL	Exit	\$1,097.00	\$1,121.00
8835RL	Exit with Thumbturn	\$1,138.00	\$1,162.00
8862RL	Bathroom	\$1,118.00	\$1,142.00
8865RL	Bathroom with Thumbturn	\$1,132.00	\$1,156.00
8866RL	Passage Lock w/ Indicator (VXX option add pg 56 also applies)	\$1,118.00	\$1,142.00
DUMMY TRIM:			
855RL	Single	\$491.50	\$503.50
838ARL	Pair	\$983.00	\$1,007.00
838BRL	Pair (Strike available upon request)	\$1,015.00	\$1,039.00
8870RLDT	Plain		
8871RLDT	Latchbolt	\$1,097.00	\$1,121.00
8872RLDT	Latchbolt x Deadbolt		

- Price includes Hotel indicator.
- See the Variations page for details.
- VN escutcheon available only with indicators. Must be ordered with "V" indicator options. See page 56 for more information. Option add also applies.

MORTISE LOCK BODIES (WITH ARMOR FRONT AND STRIKE)

Lockbodies for use with Reflections® levers shipped AFTER October 2011. For use with Reflections trim shipped prior to this date, please contact Technical Support.

FUNCTION	LOCKBODY MODEL #	LIST PRICE
LEVERS:		
8801FL	LBDY8801FL	\$509.00
8802FL	LBDY8802FL	\$644.00
8805FL	LBDY8805FL	\$588.00
8807FL	LBDY8807FL	
8808FL	LBDY8808FL	
8809FL	LBDY8809FL	
8864FL	LBDY8864FL	
8808-2FL	LBDY8808FL	
8811-2FL	LBDY8811FL	\$644.00
8812-2FL	LBDY8812FL	
8817-2FL	LBDY8817FL	\$588.00
8818-2FL	LBDY8818FL	\$644.00
8820FL	LBDY8820FL	
8822FL	LBDY8822FL	
8823FL	LBDY8823FL	
8824FL	LBDY8824FL	
8827FL	LBDY8827FL	
8832FL	LBDY8832FL	
8835FL	LBDY8835FL	
8840FL	LBDY8840FL	
8847FL	LBDY8847FL	

FUNCTION	LOCKBODY MODEL #	LIST PRICE
8828FL	LBDY8828FL	\$513.00
8829FL	LBDY8829FL	\$588.00
8830-2FL	LBDY8830FL	\$628.00
8833FL	LBDY8833FL	\$588.00
8833-2FL	LBDY8833FL	
8834FL	LBDY8834FL	
8834-2FL	LBDY8834FL	
8860FL	LBDY8860FL	\$628.00
8860-2FL	LBDY8860FL	
8861FL	LBDY8861FL	
8862FL	LBDY8862FL	\$588.00
8865FL	LBDY8865FL	
8866FL	LBDY8866FL	\$628.00
8867FL	LBDY8867FL	

NOTE: Trim priced separately.
Armor Fronts and Strikes are included with lockbodies only.
Finish must be specified.
Cylinders are not furnished with lock bodies; cylinders must be ordered separately.

PART NUMBER	LOCK FUNCTION	ALL FINISHES
ARMOR FRONT & STRIKE PACKS:		
50-0020-8801-FIN	8801, 8862	\$85.00
50-0020-8802-FIN	8802, 8811, 8822, 8823, 8860, 8861	
50-0020-8805-FIN	8805, 8808, 8809, 8817, 8828, 8829, 8830, 8833, 8864, 8865, 8866	
50-0020-8807-FIN	8807	
50-0020-8813-FIN	8813, 8814, 8815	
50-0020-8820-FIN	8812, 8818, 8820, 8831, 8832, 8835	
50-0020-8824-FIN	8824, 8834, 8834-2	
50-0020-8847-FIN	8827, 8847	
50-0020-8867-FIN	8867	

REFLECTIONS® TRIM PACKS

LEVER DESIGNS: All Reflections® Series

ESCUTCHEON DESIGNS: E3, E4, CN, VN¹

ROSE DESIGNS: R3, R4, R5, R6, R7, R8, R9, Copenhagen - R

1. Must be ordered with "V" indicator options. See page 56 for more information. Option add also applies.

PRODUCT CODE	PRODUCT DESCRIPTION	613E 626 BSP WSP	605 606 611 612 618 619 625 629 630
LEVERS WITH ROSES:			
Specify lever design x rose design	Specify "TP" with lock function and finish	\$969.00	\$993.00
LEVERS WITH ESCUTCHEONS:			
Specify lever design x escutcheon design	Specify "TP" with lock function and finish	\$991.00	\$1,015.00

How to order example: TBR3 x TP8807 x BSP

LEVER DESIGNS: All Reflections® Series

ROSE DESIGNS: R3, R4, R5, R6, R7, R8, R9

ESCUTCHEON DESIGNS: E3, E4

MODEL #	PRODUCT DESCRIPTION	613E 626 BSP WSP	605 606 611 612 618 619 625 629 ¹ 630 ¹
LEVER ASSEMBLY - OUTSIDE:			
Design x 904	Specify Lever Design x 904 x Hand Ordering Example: TB904 x RH	\$239.00	\$263.00
LEVER ASSEMBLY - INSIDE:			
Design x 905	Specify Lever Design x 905 x Hand Ordering Example: TB905 x RH	\$239.00	\$263.00
ROSE ASSEMBLIES:			
R3-505	Inside	\$112.00	\$136.00
R3-506	Outside		
R4-505	Inside		
R4-506	Outside		
R5-505	Inside		
R5-506	Outside		
R6-505	Inside		
R6-506	Outside		
R7-505	Inside		
R7-506	Outside		
R8-505	Inside		
R8-506	Outside		
R9-505	Inside (Specify Hand)		
R9-506	Outside (Specify Hand)		
ESCUTCHEON PLATES:			
E3-88	Outside	\$354.00	\$378.00
E3-87	Inside		
E4-88	Outside		
E4-87	Inside		

NOTE: When ordering escutcheons separately, specify the model number of the escutcheon plate suffixed with the spacing number. The spacing number indicates the hole preparation in the escutcheon plate to coordinate with the lock functions.

See page 59 for escutcheon plate numbers.

1. See the Variations page for details.

8800RL SERIES ELECTRIFIED MORTISE LOCKS

LEVER DESIGNS: All Reflections® Series

ROSE DESIGNS: R3, R4, R5, R6, R7, R8, R9, Copenhagen - R

MODEL #	PRODUCT DESCRIPTION	613E 626 BSP WSP	605 606 611 612 618 619 625 629' 630'
SINGLE CYLINDER:			
8890RL	Fail Safe	\$1,544.00	\$1,568.00
8891RL	Fail Secure		
SINGLE CYLINDER WITH DEADBOLT:			
8896RL	Fail Safe	\$1,571.00	\$1,595.00
8897RL	Fail Secure		
8898RL	Fail Safe		
8899RL	Fail Secure		
DOUBLE CYLINDER:			
8894-2RL	Fail Safe	\$1,652.00	\$1,676.00
8895-2RL	Fail Secure		
DOUBLE CYLINDER WITH DEADBOLT:			
8896-2RL	Fail Safe	\$1,679.00	\$1,703.00
8897-2RL	Fail Secure		
8898-2RL	Fail Safe		
8899-2RL	Fail Secure		
NO CYLINDER OVERRIDE:			
8880RL	Fail Safe	\$1,436.00	\$1,460.00
8881RL	Fail Secure		
8884RL	Fail Safe		
8885RL	Fail Secure		

LEVER DESIGNS: All Reflections® Series

ESCUTCHEON DESIGNS: E3, E4, CN

MODEL #	PRODUCT DESCRIPTION	613E 626 BSP WSP	605 606 611 612 618 619 625 629' 630'
SINGLE CYLINDER:			
8890RL	Fail Safe	\$1,566.00	\$1,590.00
8891RL	Fail Secure		
SINGLE CYLINDER WITH DEADBOLT:			
8896RL	Fail Safe	\$1,593.00	\$1,617.00
8897RL	Fail Secure		
8898RL	Fail Safe		
8899RL	Fail Secure		
DOUBLE CYLINDER:			
8894-2RL	Fail Safe	\$1,674.00	\$1,698.00
8895-2RL	Fail Secure		
DOUBLE CYLINDER WITH DEADBOLT:			
8896-2RL	Fail Safe	\$1,701.00	\$1,725.00
8897-2RL	Fail Secure		
8898-2RL	Fail Safe		
8899-2RL	Fail Secure		
NO CYLINDER OVERRIDE:			
8880RL	Fail Safe	\$1,458.00	\$1,482.00
8881RL	Fail Secure		
8884RL	Fail Safe		
8885RL	Fail Secure		

1. See the Variations page for details.

ELECTRIFIED LOCK BODIES

Lockbodies for use with Reflections® levers shipped AFTER October 2011. For use with Reflections trim shipped prior to this date, please contact Technical Support.

FUNCTION	LOCKBODY MODEL #	DESCRIPTION	LIST PRICE
LEVERS:			
8880FL	LBDY8880FL	Fail Safe	\$928.00
8881FL	LBDY8881FL	Fail Secure	
8884FL	LBDY8884FL	Fail Safe	
8885FL	LBDY8885FL	Fail Secure	
8890FL	LBDY8890FL	Fail Safe	
8891FL	LBDY8891FL	Fail Secure	
8894-2FL	LBDY8894FL	Fail Safe	
8895-2FL	LBDY8895FL	Fail Secure	
8896FL	LBDY8896FL	Fail Safe	\$984.00
8896-2FL	LBDY8896FL	Fail Safe	
8897FL	LBDY8897FL	Fail Secure	
8897-2FL	LBDY8897FL	Fail Secure	
8898FL	LBDY8898FL	Fail Safe	
8898-2FL	LBDY8898FL	Fail Safe	
8899FL	LBDY8899FL	Fail Secure	
8899-2FL	LBDY8899FL	Fail Secure	

ELECTRIFIED AND MECHANICAL OPTIONS:		
LBM: SPDT switch that monitors full retraction of latchbolt (available option for electrified functions only)	ADD	\$334.00
DBM: SPDT switch that monitors full retraction of deadbolt		\$307.00
REX: SPDT switch that monitors activation of free lever		\$850.00
MELR: Motorized Electric Latch Retraction (available option for the following functions with lever trim: 8801RL, 8805RL, 8830-2RL)		

See page 208 for power supplies and electrified accessories.

PART NUMBER	LOCK FUNCTION	ALL FINISHES
ARMOR FRONT & STRIKE PACKS:		
50-0020-8805-FIN	8880, 8881, 8884, 8885, 8890, 8891, 8892, 8893, 8894, 8894-2, 8895, 8895-2	\$85.00
50-0020-8820-FIN	8896, 8896-2, 8897, 8897-2, 8898, 8898-2, 8899, 8899-2	

NOTE: Trim priced separately.
Armor Fronts and Strikes included with lockbodies only. Finish must be specified.
Cylinders are not furnished with lock bodies; cylinders must be ordered separately.

COMPETITOR INDICATOR KITS VARIATIONS

STANDARD FINISHES: Product will be furnished only in the finishes in which it is priced.

ANSI/BHMA CODE	FINISH DESCRIPTION
BRASS:	
605	Bright Brass, Clear Coated
606	Satin Brass, Clear Coated
BRONZE:	
612	Satin Bronze, Clear Coated
613E	Dark Oxidized Satin Bronze - equivalent
CHROME:	
625	Bright Chrome Plated
626	Satin Chrome Plated

ANSI/BHMA CODE	FINISH DESCRIPTION
STAINLESS STEEL:	
629*	Bright Stainless Steel
630*	Satin Stainless Steel
NICKEL:	
618	Bright Nickel Plated, Clear Coated
619	Satin Nickel Plated, Clear Coated

*Indicator escutcheons are nickel plated to match stainless steel

COMPETITOR INDICATOR KITS FOR BEST® MORTISE LOCKS

DESCRIPTION	MODEL #	LIST PRICE
Keyed Functions	BE190	\$286.00
Cointurn for Emergency Override	BE193	
Thumbturn	BE194	

COMPETITOR INDICATOR KITS FOR SCHLAGE® MORTISE

DESCRIPTION	MODEL #	LIST PRICE
Keyed Functions	SC190	\$286.00
Cointurn for Emergency Override	SC193	
Thumbturn	SC194	
No Input - Blank	SC197	

OPTIONS:

DESCRIPTION	SPECIFY OPTION CODE
Unlocked/Locked - Green/Red	V10
Vacant/Occupied - Green/Red	V20
Icons Only - Green/Red	V30
Unlocked/Locked - White/Red	V40
Vacant/Occupied - White/Red	V50
Icons Only - White/Red	V60
Ouvert/Fermé - Green/Red (French)	V10F
Libre/Occupée - Green/Red (French)	V20F

NOTES:

When ordering competitor indicator kits, specify finish and V code required. i.e. SC190 x 626 x V10.

Kits accommodate indicators on one side of the door only. If indicators are required for both sides, 2 kits must be ordered as required by function.

COMPETITOR INDICATOR KITS VARIATIONS

PART NUMBER	DESCRIPTION	LIST PRICE
50-8800-2304 x Finish	Best® Sectional Escutcheon - Cylinder	\$124.00
50-8800-2303 x Finish	Schlage® Sectional Escutcheon - Cylinder	
50-8800-0390* x Finish	Best Sectional Escutcheon - Thumbturn (includes thumbturn)	
50-8800-0389* x Finish	Schlage Sectional Escutcheon - Thumbturn (includes thumbturn)	
50-8800-2302 x Finish	Best or Schlage Sectional Escutcheon - No Input / Blank	
50-8800-2301 x Finish	Best or Schlage Sectional Escutcheon - Cointurn (cointurn not included)	\$123.00
856F049	Indicator Window	\$5.00
858F241	Display Assembly - Green Unlocked / Red Locked	\$86.00
858F251	Display Assembly - Green Vacant / Red Occupied	
858F261	Display Assembly - Green Unlocked Icon / Red Locked Icon	
858F271	Display Assembly - White Unlocked / Red Locked	
858F281	Display Assembly - White Vacant / Red Occupied	
858F291	Display Assembly - White Unlocked Icon / Red Locked Icon	
865F241	Display Assembly - Green Ouvert / Red Fermé	
865F251	Display Assembly - Green Libre / Red Occupée	\$18.00
855F619	Best Spindle Cam - Thumbturn	
855F707*	Best Spindle Cam - Cylinder / No Input / Blank	\$21.00
855F747* x Finish	Best Spindle Cam - Cointurn (includes cointurn)	
50-8800-7318* x Finish	Schlage Spindle Cam - Cointurn (includes cointurn)	\$18.00
50-8800-9322	Schlage Spindle Cam - Thumbturn	
50-8800-7314*	Schlage Spindle Cam - Cylinder / No Input / Blank	\$5.00
50-8800-0391	Retaining Pad and Screw Kit	
855F658	Mounting Plate	\$17.00
858F497 x Finish	Screw Pack	\$16.00
50-8800-9327	Template Kit	\$19.00

*These parts are for 1-3/4" standard thickness doors. For other thicknesses, please contact factory.

STANDARD FINISHES: Products will be furnished only in the following finishes.

ANSI/BHMA CODE	FINISH DESCRIPTION
BRASS:	
605	Bright Brass, Clear Coated
BRONZE:	
613E	Dark Oxidized Satin Bronze - equivalent
CHROME:	
626	Satin Chrome Plated
PAINTED:	
BSP	Black Suede Powder Coat

PRODUCT OPTIONS	DEDUCT	ADD
SPECIAL STRIKES:		
371 Strike with 1", 1-1/2", 1-3/4" or 2" lip with box	—	\$2.00
ANSI Strike 497 with 1-1/8", 1-1/2" or 1-3/4" lip	—	\$19.00
DOORS 1-3/4" THICK:	—	STD
KNURLING: Not Available		
ABRASIVE COATING:		
Outside (ABCO) or Inside (ABCI) Only	--	\$71.00
Both Sides (ABCB)	--	\$142.00

YPL SERIES GRADE 1 INDICATOR LOCKS

LEVER DESIGN: Augusta-AU

MODEL #	PRODUCT DESCRIPTION	605 613E 626 BSP
NON-KEY LATCHSETS:		
YPL02	Privacy, Bedroom or Bath	\$324.00

CASE LOT: 6
SHIPPING WEIGHT: 4.5 Lbs. per lock

MODEL #	PRODUCT DESCRIPTION	ORDERED SEPARATELY	ORDERED WITH LOCKSET
STRIKES:			
70S	Full Lip Strike	\$7.00	N/C
202	Strike Box (Not Plated)	\$2.00	\$2.00
371	Strike 1-1/4" Lip with Box	\$12.00	N/C
371	Strike 1", 1-1/2", 1-3/4" or 2" Lip with Box	\$23.00	\$2.00
497	ANSI Strike Lip 1-1/4"	\$57.00	STD
497	ANSI Strike 1-1/8", 1-1/2" or 1-3/4" Lip	\$64.00	\$19.00
*PLAIN LATCHBOLTS:			
693A	2-3/4" Backset, 2-1/4" x 1-1/8" Square Front	\$109.00	STD
378PL	2-3/8" Backset, 2-1/4" x 1" Square Front	\$42.00	N/C

*All latches have universal fronts for both flat and beveled door edges.

PRODUCT DESCRIPTION	MODEL/PART NUMBER	NO FINISH
MISCELLANEOUS PARTS:		
Adapter Plate Kit for 1-3/8" Door - (sold as set of 2 plates)	APK-2	\$21.00
Mounting Screw Pack (includes 2 mounting screws, ANSI strike screws and latch screws)	81-9400-0090 (specify finish)	\$7.00
Screw Pack for ANSI Strike and Latch	81-9400-0038 (specify finish)	\$4.00
Screw Pack for "T" Strike or Full Lip Strike & Latch	81-9400-0009 (specify finish)	

When Ordering: Specify design, function, hand and finish.

5400LN SERIES GRADE 1 LEVER LOCKS VARIATIONS



Hurricane

STANDARD FINISHES: Product will be furnished only in the finishes in which it is priced.

ANSI/BHMA CODE	FINISH DESCRIPTION
BRASS:	
605	Bright Brass, Clear Coated
606	Satin Brass, Clear Coated
BRONZE:	
612	Satin Bronze, Clear Coated
613E	Dark Oxidized Satin Bronze - equivalent

ANSI/BHMA CODE	FINISH DESCRIPTION
CHROME:	
625	Bright Chrome Plated
626	Satin Chrome Plated
NICKEL:	
619	Satin Nickel Plated, Clear Coated
PAINTED:	
693	Black Painted
BSP	Black Suede Powder Coat
WSP	White Suede Powder Coat

PRODUCT OPTIONS	DEDUCT	ADD
LESS CYLINDER OR LESS CORE:		
Standard cylinder prep less cylinder, specify "x LC" Ordering Example: AU5407LN x LC	\$94.00	—
Large format interchangeable core prep less core, for 6-pin, specify "x ICLC" Ordering Example: AU5407LN x ICLC	\$0.00	\$0.00
7-PIN CYLINDERS AND LFIC CORES:		
Add to 6-Pin cylinder/core	—	\$2.00
INTERCHANGEABLE CORES:		
1210 – LFIC 6-Pin (includes MK or GMK) Ordering Example: AU5407LN x 1210 x 626	—	\$86.00
A600 Best® Keyway SFIC 6-or 7-Pin (includes MK or GMK) Ordering Example: B-AU5407LN x A600	—	\$76.00
NOTE: 5421LN, 5429LN, 5430LN, 5439LN Not Available with IC Cores.		
CYLINDER OPTIONS: (See Page 83 for Ordering Examples)		
Lockset with SFIC Core Prep (less core)	\$0.00	\$0.00
Lockset with Medeco®/ASSA® IC Core Prep (less core)	\$0.00	\$0.00
Lockset with Schlage® IC Core Prep (less core)	\$0.00	\$0.00
Lockset with Schlage® Standard Cylinder Prep (less cylinder)	\$38.00	\$0.00
Lockset with Schlage® "C" Keyway Cylinder (specify cylinder model number 2802)	\$0.00	\$0.00
Lockset with Corbin Russwin "L4", Corbin "60", Russwin "D1", Sargent® "LA" or Schlage® "E" Keyway Cylinder. (specify cylinder model number 3804 x keyway)	\$0.00	\$24.00
SPECIAL STRIKES:		
ANSI Strike 497 with 1 -1/8", 1-1/2" or 1-3/4" lip	—	\$19.00
371 Strike with 1", 1-1/2", 1-3/4" or 2" Lip with Box	—	\$2.00
SPLIT FINISHES: Higher List Price Applies		
LEAD SHIELDED:	—	\$277.00
KNURLING:		
Outside (KNO) or Inside (KNI) Only	--	\$116.00
Both Sides (KNB)	--	\$232.00
ABRASIVE COATING:		
Outside (ABCO) or Inside (ABCI) Only	--	\$71.00
Both Sides (ABCB)	--	\$142.00
DOORS 1-3/4" THICK:	—	STD
DOORS 1-3/8" THICK:	—	\$46.00
DOORS 2-1/4" THICK:	—	\$4.00
FLUSH TURN BUTTON: Available for 5425LN Function only. Suffix "FTB"	\$0.00	\$0.00
LOCKSET TO MEET FEMA 320: Suffix "TD" Ordering Example: AU5407LN x TD x 626	\$0.00	\$0.00
 Tornado	\$0.00	\$0.00
MICROSHIELD®: Antimicrobial coating. Specify option "YMS".	—	\$101.00

Note: Security and ACCENTRA KeyMark® Cylinders: see page 84 for pricing. These cylinders are priced and discounted separately.

When Ordering: Specify finish.

5400LN SERIES HEAVY-DUTY CYLINDRICAL LOCKS

DESIGNS: Augusta - AU Monroe - MO Pacific Beach - PB

MODEL #	PRODUCT DESCRIPTION	626	605 606 612 613E 619 625 693 BSP WSP
SINGLE CYLINDER:			
5404LN	Entry	\$868.00	\$884.00
5405LN	Storeroom or Closet		
5406LN	Service Station		
5407LN	Entry		
5408LN	Classroom		
5422LN	Corridor		
5429LN	Communicating Classroom		
5439LN	Communicating Storeroom		
DOUBLE CYLINDER:			
5417LN	Apartment, Exit or Public Toilet	\$962.00	\$978.00
5418LN	Intruder Classroom Security		
5421LN	Communicating		
5430LN	Utility, Asylum or Institutional		
NON-KEYED LATCHSETS:			
5401LN	Passage or Closet	\$742.00	\$758.00
5402LN	Privacy, Bedroom or Bath	\$794.00	\$810.00
5403LN	Patio or Privacy		
5409LN	Exit Latch		
5425LN	Privacy	\$742.00	\$758.00
5428LN	Communicating Passage		
DUMMY TRIM:			
455LN	Single Dummy Trim	\$371.00	\$379.00
455LN-D	Double Dummy Trim	\$742.00	\$758.00

CASE LOT: 10

SHIPPING WEIGHT: 6 Lbs. per lock

NOTE: See following page for optional cylinder preps, optional IC Core preps, and optional cylinders furnished with locks.

When Ordering: Specify design, function and finish.

ELECTRIFIED 5400LN SERIES HEAVY-DUTY CYLINDRICAL LOCKS

DESIGNS: Augusta - AU Monroe - MO Pacific Beach - PB

MODEL #	PRODUCT DESCRIPTION	626	605 606 612 613E 619 625 693 BSP WSP
CYLINDER OVERRIDE:			
5490LN	Fail Safe	\$1,216.00	\$1,232.00
5491LN	Fail Secure		
NO CYLINDER OVERRIDE:			
5480LN	Fail Safe	\$1,122.00	\$1,138.00
5481LN	Fail Secure		
LOCKBODIES:			
5480LN	Fail Safe	\$903.00	\$919.00
5481LN	Fail Secure		
5490LN	Fail Safe		
5491LN	Fail Secure		

CASE LOT: 10
SHIPPING WEIGHT: 6 Lbs. per lock

Note: See page 208 for power supplies and electrified accessories.

OPTIONS		
MODEL #	PRODUCT DESCRIPTION	LIST PRICE
REX (Request to Exit)	SPDT switch that monitors activation of inside lever (ordered with lock) Example: 5490LN x REX	\$307.00
REX Retrofit Kit	SPDT switch that monitors activation of inside lever (used with existing 5400LN locks, lock function must be specified when ordering.) Example: REX Retrofit Kit for 5405LN Part Number: 81-9500-1651-000	\$222.00

SFIC Core Prep: prefix "B" to trim designation. Accepts all SFIC cores, 6- or 7-Pin.

Example: B-AU5407LN x Less Core.

Medeco®/ASSA® IC Core Prep: prefix "M" to trim designation. Not Available with MO or PB Levers. 6-Pin only.

Example: M-AU5407LN x Less Core.

Schlage® IC Core Prep: prefix "SI" to trim designation. 6-Pin only.

Example: SI-AU5407LN x Less Core.

Schlage® Standard Cylinder Prep: prefix "S" to trim designation. 6-Pin only.

Example: S-AU5407LN x Less Cylinder.

Lockset with Sargent® "LA" Keyway Cylinder. 6-Pin only.

Example: AU5407LN x 3804.

Lockset with Schlage® "C" Keyway Cylinder. 6-Pin only.

Example: AU5407LN x 2802.

When Ordering: Specify design, function and finish.

5400LN SERIES HEAVY-DUTY CYLINDRICAL LOCK PARTS

MODEL #	PRODUCT DESCRIPTION	ORDERED SEPARATELY	ORDERED WITH LOCKSET
PLAIN LATCHBOLTS:			
693	Beveled, 2-3/4" Backset, 1/2" Throw	\$109.00	STD
F693	Flat, 2-3/4" Backset, 1/2" Throw		N/C
3693	Beveled, 3-3/4" Backset, 1/2" Throw	\$117.00	\$7.00
DEADLOCKING LATCHBOLTS:			
694	Beveled, 2-3/4" Backset, 1/2" Throw	\$139.00	STD
F694	Flat, 2-3/4" Backset, 1/2" Throw		N/C
3694	Beveled, 3-3/4" Backset, 1/2" Throw	\$155.00	\$16.00
480B	Beveled, 2-3/4" Backset, 3/4" Throw	\$265.00	\$126.00
F480B	Flat, 2-3/4" Backset, 3/4" Throw		
3480B	Beveled, 3-3/4" Backset, 3/4" Throw	\$279.00	\$140.00
BACKSET LINKS:			
481	Extension Link	\$72.00	\$72.00
481DL	Extension Link (use with deadlocking latchbolts)		
482	Extension Link	\$98.00	\$98.00
484	Extension Link	\$214.00	\$214.00
STRIKES:			
371	Strike 1-1/4" Lip with Box	\$12.00	N/C
371	Strike 1", 1-1/2", 1-3/4" or 2" Lip with Box	\$23.00	\$2.00
497	ANSI Strike 1-1/4" Lip	\$57.00	STD
497	ANSI Strike 1-1/8", 1-1/2" or 1-3/4" Lip	\$64.00	\$19.00
497B	Blank ANSI Strike 1-1/8" Lip	\$57.00	—
202	Strike Box (not plated)	\$2.00	\$2.00

MODEL #	PRODUCT DESCRIPTION	ORDERED SEPARATELY	ORDERED WITH LOCKSET
CYLINDERS:			
1802	Standard Cylinder 6-Pin	\$94.00	N/C
1802S	Standard Inside Cylinder 6-Pin for 5417LN Function		
1802A	Standard Cylinder 7-Pin	\$96.00	\$2.00
5802	Security Cylinder 6-Pin	\$373.00	\$279.00
5802A	Security Cylinder 7-Pin	\$377.00	\$283.00
1210	Large Format Interchangeable Core Only 6-Pin	\$86.00	\$86.00
1220	Large Format Interchangeable Core Only 7-Pin	\$88.00	\$88.00
5210	Security Large Format Interchangeable Core Only 6-Pin	\$343.00	\$343.00
5220	Security Large Format Interchangeable Core Only 7-Pin	\$347.00	\$347.00
K402	ACCENTRA KeyMark® Cylinder	\$118.00	\$24.00
K800	ACCENTRA KeyMark® Large Format Interchangeable Core Only 6-or 7-Pin	\$126.00	\$126.00
K600	ACCENTRA KeyMark® Small Format Interchangeable Core Only 6-or 7-Pin	\$120.00	\$120.00
A600	Best® Keyway Small Format Interchangeable Core Only 6-or 7-Pin	\$76.00	\$76.00
2802	Schlage® "C" Keyway Cylinder 6-Pin - 0-bitted or Keyed Random	\$94.00	N/C
3804	Other Manuf. Keyway Cylinder 6-Pin - Keyed Random, Specify Keyway	\$118.00	\$24.00
107S	Schlage® Cylinder Adapter Kit	\$28.00	\$28.00

When Ordering: Specify finish.

5400LN SERIES HEAVY-DUTY CYLINDRICAL LOCK PARTS

DESCRIPTION	FUNCTIONS	AU	MO	PB
LEVERS ONLY:				
Plain Inside	01, 05, 08, 09, 28, 455LN	14-5401-6063	14-5401-6064	14-5401-6062
Plain Outside	01	14-5401-6063	14-5401-6064	14-5401-6062
Privacy Outside	02	14-5402-6025	14-5402-6024	14-5402-6023
Cylinder std 6 or 7 pin	04, 05, 06, 07, 08, 17, 18, 21, 22, 29, 30	14-5407-6038	14-5407-6042	14-5407-6062
Button	02, 03, 06, 07, 22, 25	14-5407-6038	14-5407-6042	14-5407-6062
I/S ACCENTRA LFIC 6-Pin	17, 18	14-5417-6021	14-5417-6030	14-5417-6040
I/S ACCENTRA LFIC 7-Pin	17, 18	14-5417-6022	14-5417-6031	14-5417-6041
I/S SFIC 6- or 7-Pin	17, 18	14-5417-6029	14-5417-6032	14-5417-6042
I/S Schlage® LFIC 6-Pin	17, 18	14-5417-6059	14-5417-6061	14-5417-6060
I/S Medeco®/ASSA® LFIC	17, 18	14-5417-6023	N/A	N/A

PRODUCT DESCRIPTION	ALL FINISHES
ALL LEVERS	\$166.00

DESCRIPTION	FUNCTIONS	AU	MO	PB
LEVER ASSEMBLIES:				
Plain O/S Security	03, 09	14-5403-0051	14-5403-0052	14-5403-0053
O/S ACCENTRA LFIC 6-Pin	04, 05, 06, 07, 08, 17, 18, 22	14-5407-0076	14-5407-0019	14-5407-0030
O/S ACCENTRA LFIC 7-Pin	04, 05, 06, 07, 08, 17, 18, 22	14-5407-0077	14-5407-0021	14-5407-0031
O/S SFIC 6- or 7-Pin	04, 05, 06, 07, 08, 17, 18, 22	14-5407-0040	14-5407-0041	14-5407-0042
O/S Schlage® LFIC 6-Pin	04, 05, 06, 07, 08, 17, 18, 22	14-5407-0904	14-5407-6209	14-5407-0905
O/S Medeco®/ASSA® LFIC 6-Pin	04, 05, 06, 07, 08, 17, 18, 22	14-5407-0078	N/A	N/A

PRODUCT DESCRIPTION	ALL FINISHES
ALL LEVER ASSEMBLIES	\$206.00

When Ordering: Specify finish.

5400LN SERIES HEAVY-DUTY CYLINDRICAL LOCK PARTS

MODEL #	PRODUCT DESCRIPTION	PART NUMBER	ALL FINISHES
LOCKBODIES: (specify finish)			
5401LN	Passage or Closet	14-5401-0914	\$149.00
5402LN	Privacy, Bedroom or Bath	14-5402-0902	\$171.00
5403LN	Patio or Privacy	14-5402-0902	
5404LN	Entry	14-5404-0528	\$214.00
5405LN	Storeroom or Closet	14-5405-0901	
5406LN	Service Station	14-5406-0402	
5407LN	Entry	14-5407-0902	
5408LN	Classroom	14-5408-0901	
5409LN	Exit Latch	14-5405-0901	\$247.00
5417LN	Apartment, Exit or Public Toilet	14-5417-0902	
5418LN	Intruder Classroom Security	14-5418-0902	
5421LN	Communicating	14-5421-0901	\$214.00
5422LN	Corridor	14-5422-0902	
5425LN	Privacy	14-5425-0114	\$214.00
5428LN	Communicating Passage	14-5428-0111	\$149.00
5429LN	Communicating Classroom	14-5429-0007	\$214.00
5430LN	Utility, Asylum or Institutional	14-5430-0901	\$247.00
5439LN	Communicating Storeroom	14-5439-0001	\$214.00

PRODUCT DESCRIPTION	PART NUMBER	NO FINISH
MISCELLANEOUS PARTS:		
Rose Scalp	14-5401-2711-(specify finish)	\$38.00
Spacers for 1-3/8" Door - Available only in sets	001661	\$48.00
Inside Rose and Shank Assembly	14-5401-0656-048	\$57.00
Outside Rose and Shank Assembly	14-5407-0108-048	\$65.00
Through Bolts (price each - 2 required)	81-0011-0588-036	\$4.00
Retainer Spring Pad	14-5407-9034-999	\$4.00
Blank Rose Assembly	14-5401-0909-000	\$75.00
Dummy Rose Assembly	14-5455-0081-048	\$53.00
Screw Pack for ANSI Strike and Latch	81-9400-0038-(specify finish)	\$4.00
Screw Pack for "T" Strike and Latch	81-9400-0009-(specify finish)	
Cylindrical Drill Jig	14-9000-9500	\$25.00

When Ordering: Specify finish where **noted**.

5400CK SERIES GRADE 1 KNOB LOCKS VARIATIONS

STANDARD FINISHES: Product will be furnished only in the finishes in which it is priced.

ANSI/BHMA CODE	FINISH DESCRIPTION
BRASS:	
605	Bright Brass, Clear Coated
BRONZE:	
613E	Dark Oxidized Satin Bronze - equivalent

ANSI/BHMA CODE	FINISH DESCRIPTION
STAINLESS STEEL:	
630	Satin Stainless Steel

PRODUCT OPTION	DEDUCT	ADD
LESS CYLINDER OR LESS CORE:		
Standard cylinder prep less cylinder, specify "x LC" Ordering Example: CA5407CK x LC	\$94.00	—
INTERCHANGEABLE CORES:		
A600 Best® Keyway SFIC 6-or 7-Pin (includes MK or GMK) Ordering Example: B-CA5407CK x A600	—	\$76.00
CYLINDER OPTION:		
Lockset with SFIC Core Prep (less core) Carolina (CA) Knob only.	—	\$0.00
SPECIAL STRIKES:		
ANSI Strike 497 with 1 1/8", 1 1/2" or 1 3/4" lip	—	\$19.00
371 Strike 1-1/4" Lip with Box	—	N/C
371 Strike 1", 1-1/2", 1-3/4" or 2" Lip with Box	—	\$2.00
SPLIT FINISHES: Not available		
KNURLING: Not available		
ABRASIVE COATING: Not available		
MICROSHIELD®: Not available		

When Ordering: Specify finish where noted.

5400CK SERIES HEAVY-DUTY CYLINDRICAL LOCKSETS

DESIGNS: Carolina - CA

MODEL #	PRODUCT DESCRIPTION	605 613E 630
SINGLE CYLINDER:		
5405CK	Storeroom or Closet	\$755.00
5407CK	Entry	
5408CK	Classroom	
DOUBLE CYLINDER:		
5430CK	Utility, Asylum or Institutional	\$849.00
NON-KEYED LATCHSETS:		
5401CK	Passage or Closet	\$649.00
5402CK	Privacy, Bedroom or Bath	\$652.00
DUMMY TRIM:		
5455CK	Single Dummy Trim	\$466.00

CASE LOT: 10

SHIPPING WEIGHT: Approx. 3 Lbs. per lock

SFIC Core Prep: prefix "B" to trim designation, 6- or 7-Pin.

Example: B-CA5407CK x Less Core.

When Ordering: Specify design, function and finish.

5400CK SERIES HEAVY-DUTY CYLINDRICAL LOCK PARTS

MODEL #	PRODUCT DESCRIPTION	ORDERED SEPARATELY	ORDERED WITH LOCKSET
PLAIN LATCHBOLTS:			
693A	Universal, 2-3/4" Backset, 1/2" Throw	\$109.00	STD
DEADLOCKING LATCHBOLTS:			
694A	Universal, 2-3/4" Backset, 1/2" Throw	\$91.00	STD
STRIKES:			
371	Strike 1-1/4" Lip with Box (Optional)	\$12.00	N/C
371	Strike 1", 1-1/2", 1-3/4" or 2" Lip with Box (Optional)	\$23.00	\$2.00
497	ANSI Strike 1-1/4" Lip	\$57.00	STD
497	ANSI Strike 1-1/2" or 1-3/4" Lip Length	\$64.00	\$19.00
497B	ANSI Blank Strike (Optional)	\$57.00	—
202	Strike Box (not plated)	\$2.00	\$2.00
MISCELLANEOUS:			
81-2012-0416	#8-8-32 x 3/4" Phillips flat head combination screw pack (specify finish)	\$2.00	\$2.00
81-2022-0416	#8-8-32 x 3/4" Phillips flat head combination screw pack (specify finish)		
81-2012-0620	#12-12-24 x 1" Phillips flat head combination screw pack (specify finish)		
14-5400-0608	Screw pack (includes latchbolt, strike and through bolt screws) Specify finish	\$8.00	\$8.00
14-5400-0610-999	SFIC Tailpiece Kit (includes tailpiece plus spacer for 6-pin)	\$29.00	\$29.00

MODEL #	PRODUCT DESCRIPTION	ORDERED SEPARATELY	ORDERED WITH LOCKSET
CYLINDER X TAILPIECE:			
1803-54K	Standard Cylinder 6-Pin	\$94.00	N/C
5803-54K	Security Cylinder 6-Pin	\$373.00	\$279.00
K403-54K	ACCENTRA KeyMark® Cylinder	\$118.00	\$118.00
K600	ACCENTRA KeyMark® Cylinder Small Format Interchangeable Core Only 6-or 7-Pin	\$120.00	\$120.00
A600	Best® Keyway Small Format Interchangeable Core Only 6-or 7-Pin	\$76.00	\$76.00

When Ordering: Specify finish.

5300LN SERIES GRADE 2 LEVER LOCKS VARIATIONS



STANDARD FINISHES: Product will be furnished only in the finishes in which it is priced.

ANSI/BHMA CODE	FINISH DESCRIPTION
BRASS:	
605	Bright Brass, Clear Coated
606	Satin Brass, Clear Coated
BRONZE:	
612	Satin Bronze, Clear Coated
613E	Dark Oxidized Satin Bronze - equivalent

ANSI/BHMA CODE	FINISH DESCRIPTION
CHROME:	
625	Bright Chrome Plated
626	Satin Chrome Plated
NICKEL:	
619	Satin Nickel Plated, Clear Coated
PAINTED:	
693	Black Painted
BSP	Black Suede Powder Coat
WSP	White Suede Powder Coat

PRODUCT OPTIONS	DEDUCT	ADD
LESS CYLINDER OR LESS CORE:		
Standard cylinder prep less cylinder, specify "x LC" Ordering Example: AU5307LN x LC	\$94.00	—
Large format interchangeable core prep less core, for 6-pin, specify "x ICLC" Ordering Example: AU5307LN x ICLC	\$0.00	\$0.00
CYLINDERS AND LFIC CORES: 6-Pin only		
INTERCHANGEABLE CORES:		
1210 – LFIC 6-Pin (includes MK or GMK) Ordering Example: AU5307LN x 1210 x 626	—	\$86.00
A600 Best® Keyway SFIC 6-or 7-Pin (includes MK or GMK) Ordering Example: B-AU5307LN x A600	—	\$76.00
NOTE: 5318LN, 5321LN, 5329LN, 5330LN, 5339LN not available with IC Cores.		
CYLINDER OPTIONS: (See page 93 for ordering example)		
Lockset with SFIC Core Prep (less core)	\$0.00	\$0.00
Lockset with Medeco®/ASSA® IC Core Prep (less core)	\$0.00	\$0.00
Lockset with Schlage® IC Core Prep (less core)	\$0.00	\$0.00
Lockset with Schlage® Standard Cylinder Prep (less cylinder)	\$38.00	\$0.00
Lockset with Schlage® "C" Keyway Cylinder (specify cylinder model number 2803-47L)	\$0.00	\$0.00
Lockset with Corbin Russwin "L4", Corbin "60", Russwin "D1", Sargent® "LA" or Schlage® "E" Keyway Cylinder. (specify cylinder model number 3803-47L x keyway)	\$0.00	\$24.00
SPECIAL STRIKES:		
ANSI Strike 497 with 1-1/8", 1-1/2" or 1-3/4" lip	—	\$19.00
SPLIT FINISHES: Higher List Price Applies		
KNURLING: Available for all levers in 613E, 626 and BSP finishes only		
Outside (KNO) or Inside (KNI) Only	--	\$116.00
Both Sides (KNB)	--	\$232.00
ABRASIVE COATING:		
Outside (ABCO) or Inside (ABCI) Only	--	\$71.00
Both Sides (ABCB)	--	\$142.00
DOORS 1-3/4" THICK: Adjustable to 2" Thick	—	STD
DOORS 1-3/8" OR 2-1/4" THICK:	—	\$4.00
FLUSH TURN BUTTON: Available for 5325LN Function only. Suffix "FTB"	\$0.00	\$0.00
MICROSHIELD®: Antimicrobial coating. Specify "YMS".	—	\$101.00

Note: Security and ACCENTRA KeyMark® Cylinders: see page 94 for pricing. These cylinders are priced and discounted separately.

When Ordering: Specify design and finish.

5300LN SERIES CYLINDRICAL LEVER LOCKS

DESIGNS: Augusta - AU Pacific Beach - PB Monroe - MO

MODEL #	PRODUCT DESCRIPTION	626	605 606 612 613E 619 625 693 BSP WSP
SINGLE CYLINDER:			
5304LN	Entry	\$418.00	\$434.00
5305LN	Storeroom or Closet		
5306LN	Service Station		
5307LN	Entry		
5308LN	Classroom		
5322LN	Corridor		
5329LN	Communicating Classroom		
5339LN	Communicating Storeroom		
DOUBLE CYLINDER:			
5318LN	Intruder Classroom Security	\$512.00	\$528.00
5321LN	Communicating		
5330LN	Utility, Asylum or Institutional		
NON-KEY LATCHSETS:			
5301LN	Passage or Closet	\$343.00	\$359.00
5302LN	Privacy, Bedroom or Bath	\$367.00	\$383.00
5303LN	Patio or Privacy		
5309LN	Exit Latch		
5325LN	Privacy	\$343.00	\$359.00
5328LN	Communicating Passage		
DUMMY TRIM:			
355LN	Single Dummy Trim	\$146.00	\$154.00
355LN-D	Double Dummy Trim	\$292.00	\$308.00

CASE LOT: 10
SHIPPING WEIGHT: 4.8 Lbs. per lock

When Ordering: Specify design, function, hand and finish.

ELECTRIFIED 5300LN SERIES CYLINDRICAL LEVER LOCKS

DESIGNS: Augusta - AU Monroe - MO Pacific Beach - PB

MODEL #	PRODUCT DESCRIPTION	626	605 606 612 613E 619 625 693 BSP WSP
CYLINDER OVERRIDE:			
5390LN	Fail Safe	\$758.00	\$774.00
5391LN	Fail Secure		
NO CYLINDER OVERRIDE:			
5380LN	Fail Safe	\$664.00	\$680.00
5381LN	Fail Secure		
LOCKBODIES:			
5380LN	Fail Safe	\$527.00	\$543.00
5381LN	Fail Secure		
5390LN	Fail Safe		
5391LN	Fail Secure		

CASE LOT: 10
SHIPPING WEIGHT: 4.8 Lbs. per lock

Note: See page 208 for power supplies and electrified accessories.

SFIC Core Prep: prefix "B" to trim designation. Accepts all SFIC cores, 6- or 7-Pin.
Example: B-AU5307LN x Less Core.

Medeco®/ASSA® IC Core Prep: prefix "M" to trim designation. Not Available with MO or PB Levers. 6-Pin only.
Example: M-AU5307LN x Less Core.

Schlage® IC Core Prep: prefix "SI" to trim designation. 6-Pin only.
Example: SI-AU5307LN x Less Core.

Schlage® Cylinder Prep: prefix "S" to trim designation. 6-Pin only.
Example: S-AU5307LN x Less Cylinder.

Lockset with Sargent® "LA" Keyway Cylinder. 6-Pin only.
Example: AU5307LN x 3803-47L x LA.

Lockset with Schlage® "C" Keyway Cylinder. 6-Pin only.
Example: AU5307LN x 2803-47L.

When Ordering: Specify design, function and finish.

5300LN SERIES CYLINDRICAL LEVER LOCK PARTS

MODEL #	PRODUCT DESCRIPTION	ORDERED SEPARATELY	ORDERED WITH LOCKSET
STRIKES:			
70S	Full Lip Strike (Optional)	\$7.00	N/C
71S	1/4" Radius Full Lip Strike (Optional)		N/C
202	Strike Box (Not Plated)	\$2.00	\$2.00
371	Strike 1-1/4" Lip with Box	\$12.00	N/C
371	Strike 1", 1-1/2", 1-3/4" or 2" Lip with Box	\$23.00	\$2.00
497	ANSI Strike Lip 1-1/4"	\$57.00	STD
497	ANSI Strike with 1-1/8", 1-1/2" or 1-3/4" Lip	\$64.00	\$19.00
497B	Blank ANSI Strike (Optional)	\$57.00	--
*PLAIN LATCHBOLTS:			
380BN	2-3/4" Backset, 2-1/4" x 1-1/8" Front	\$45.00	STD
380DN	2-3/4" Backset, 2-1/4" x 1" Front	\$45.00	N/C
378N	2-3/8" Backset, 2-1/4" x 1" Front	\$45.00	N/C
3380BN	3-3/4" Backset, 2-1/4" x 1-1/8" Front	\$59.00	\$14.00
3380DN	3-3/4" Backset, 2-1/4" x 1" Front	\$59.00	\$14.00
*DEADLOCKING LATCHBOLTS:			
380AN	2-3/4" Backset, 2-1/4" x 1-1/8" Front	\$53.00	STD
380CN	2-3/4" Backset, 2-1/4" x 1" Front		N/C
380N	2-3/8" Backset, 2-1/4" x 1" Front		N/C
3380AN	3-3/4" Backset, 2-1/4" x 1-1/8" Front	\$75.00	\$22.00
3380CN	3-3/4" Backset, 2-1/4" x 1" Front		

* All latches have universal fronts for both flat and beveled door edges.

MODEL #	PRODUCT DESCRIPTION	ORDERED SEPARATELY	ORDERED WITH LOCKSET
BACKSET EXTENSION LINKS:			
381N	Link 5" Total Backset for 378N/380N Latchbolts	\$37.00	\$37.00
381AN	Link 5" Total Backset for 380AN/380BN Latchbolts		

MODEL #	PRODUCT DESCRIPTION	ORDERED SEPARATELY	ORDERED WITH LOCKSET
CYLINDERS:			
1803-47L	Standard Cylinder 6-Pin	\$94.00	N/C
5803-47L	Security Cylinder 6-Pin	\$373.00	\$279.00
1210	Large Format Interchangeable Core Only 6-Pin	\$86.00	\$86.00
5210	Security Large Format Interchangeable Core Only 6-Pin	\$343.00	\$343.00
K402	ACCENTRA KeyMark® Cylinder	\$118.00	\$24.00
K800	ACCENTRA KeyMark® Large Format Interchangeable Core Only 6-Pin	\$126.00	\$126.00
K600	ACCENTRA KeyMark® Small Format Interchangeable Core Only 6-or 7-Pin	\$120.00	\$120.00
A600	Best® Keyway Small Format Interchangeable Core Only 6-or 7-Pin	\$76.00	\$76.00
2803-47L	Schlage® "C" Keyway Cylinder 6-Pin - 0-bitted or Keyed Random	\$94.00	N/C
3803-47L	Other Manuf. Keyway Cylinder 6-Pin - Keyed Random, Specify Keyway	\$118.00	\$24.00
108S, *108L	Schlage® Cylinder Adapter Kit	\$28.00	\$28.00
9053	Cylinder Sleeve for K402 Cylinder	\$11.70	\$11.70
14-1803-9001-999	Cylinder Sleeve for 1803-47L/5803-47L Cylinders	\$11.70	N/C

*2-1/4" Door

When Ordering: Specify finish.

5300LN SERIES CYLINDRICAL LEVER LOCK PARTS

MODEL #	PRODUCT DESCRIPTION	1-3/8", 1-3/4", 2" DOOR	2-1/4" DOOR	ALL FINISHES
LOCKBODIES: (specify finish)				
5301LN	Passage or Closet	14-5401-0914	14-5401-0924	\$149.00
5302LN	Privacy Bedroom or Bath	14-5402-0902	14-5402-0903	\$171.00
5303LN	Patio or Privacy	14-5402-0902	14-5402-0903	
5304LN	Entry	14-5407-0902	14-5407-0903	\$214.00
5305LN	Storeroom or Closet	14-5405-0901	14-5405-0902	
5306LN	Service Station	14-5406-0402	14-5406-0403	
5307LN	Entry	14-5407-0902	14-5407-0903	
5308LN	Classroom	14-5408-0901	14-5408-0902	
5309LN	Exit Latch	14-5405-0902	14-5405-0902	\$214.00
5318LN	Intruder Classroom Security	14-5418-0902	14-5418-0903	\$247.00
5321LN	Communicating	14-5421-0901	14-5421-0902	
5322LN	Corridor	14-5422-0903	14-5422-0906	\$214.00
5325LN	Privacy	14-5406-0402	14-5406-0403	\$171.00
5328LN	Communicating Passage	14-5428-0111	14-5428-0112	\$149.00
5329LN	Communicating Classroom	14-5429-0007	14-5429-0008	\$214.00
5330LN	Utility, Asylum or Institutional	14-5430-0901	14-5430-0902	\$247.00
5339LN	Communicating Storerrrom	14-5439-0001	14-5439-0002	\$214.00
Lockbodies for 1-3/8" or 2-1/4" doors			ADD	\$4.20

NOTE: Lockbodies for use with locksets ordered prior to March 2012 will require a new rose plate assembly. Therefore, part number 14-5300-0030-010 must also be ordered.

*1-3/8" doors must be specified in the order

MODEL #	PRODUCT DESCRIPTION	AU	MO	PB	ALL FINISHES
LEVERS ONLY:					
350L	Plain Inside	14-5301-6040	14-5301-6902	14-5301-6054	\$89.00
350L	Passage Outside	14-5301-6040	14-5301-6902	14-5301-6054	
350PO	Patio Outside	14-5303-6060	14-5303-6067	14-5303-6066	
350EK	Outside Emergency Key	14-5302-6058	14-5302-6585	14-5302-6062	
350LK	Cylinder	14-5300-6039	14-5305-6056	14-5305-6054	
350LP	Button	14-5300-6039	14-5305-6056	14-5305-6054	
350LR	ACCENTRA LFIC 1-3/4" Door	14-5305-0006	14-5305-0014	14-5305-0010	\$110.00
350LR	ACCENTRA LFIC 2-1/4" Door	14-5305-0018	14-5305-0026	14-5305-0022	
350LB	SFIC 1-3/4" Door	14-5305-0008	14-5305-0016	14-5305-0012	
350LB	SFIC 2-1/4" Door	14-5300-6030	14-5305-0028	14-5305-0024	
350LS	Schlage® LFIC 1-3/4" Door	14-5305-0009	N/A	14-5305-0013	
350LS	Schlage® LFIC 2-1/4" Door	14-5305-0021		14-5305-0025	
	ASSA/Medeco LFIC 1-3/4" Door	14-5305-6028		N/A	

When Ordering: Specify design, function and finish.

5300LN SERIES CYLINDRICAL LEVER LOCK PARTS

PRODUCT DESCRIPTION	PART NUMBER	ALL FINISHES
OTHER COMPONENTS:		
Lever Support Spring	14-5300-1021-999	\$6.90
Inside Rose Support Assembly	14-5301-0705-048	\$40.60
Inside Rose Support Assembly (5321LN,5329LN)	14-5321-0003-048	
Outside Rose Support Assembly	14-5303-0001-048	
Outside Rose Support Assembly (5301LN,5302LN)	14-5301-0704-048	
Rose Scalp (specify finish)	14-5300-X024-(specify finish)	\$29.50
Blank Rose	14-5401-6003-(specify finish)	\$59.00
Dummy Rose Assembly	14-0355-0002-048	\$22.30
Screw Pack for ANSI Strike & Latch	81-9400-0038-(specify finish)	\$4.00
Screw Pack for "T" Strike and Latch	81-9400-0009-(specify finish)	
Through Bolt Screws 1-3/8" & 1-3/4" Doors (2 required)	81-0011-0580-036 (each)	
Through Bolt Screws 2" & 2-1/4" Doors (2 required)	81-0011-0582-036 (each)	

When Ordering: Specify design, function and finish.

4700LN GRADE 1 CYLINDRICAL LOCKS VARIATIONS



Hurricane

STANDARD FINISHES: Products will be furnished only in the following finishes.

ANSI/BHMA CODE	FINISH DESCRIPTION
BRASS:	
605	Bright Brass, Clear Coated
606	Satin Brass, Clear Coated
BRONZE:	
612	Satin Bronze, Clear Coated
613E	Dark Oxidized Satin Bronze - equivalent

ANSI/BHMA CODE	FINISH DESCRIPTION
CHROME:	
625	Bright Chrome Plated
626	Satin Chrome Plated
NICKEL:	
619	Satin Nickel Plated, Clear Coated
PAINTED:	
BSP	Black Suede Powder Coat
WSP	White Suede Powder Coat

PRODUCT OPTIONS	DEDUCT	ADD
LESS CYLINDER OR LESS CORE:		
Standard cylinder prep less cylinder, specify "x LC" Ordering Example: AU4707LN x LC	\$94.00	—
Large format interchangeable core prep less core, for 6-pin, specify "x ICLC" Ordering Example: AU4707LN x ICLC	\$0.00	\$0.00
CYLINDERS AND LFIC CORE: 6-Pin only		
INTERCHANGEABLE CORES:		
1210 – LFIC 6-Pin (includes MK or GMK) Ordering Example: AU4707LN x 1210 x 626	—	\$86.00
A600 Best® Keyway SFIC 6-or 7-Pin (includes MK or GMK) Ordering Example: B-AU4707LN x A600	—	\$76.00
NOTE: 4718LN, 4721LN, 4729LN, 4730LN, 4739LN not available with IC Cores.		
CYLINDER OPTIONS: (See page 99 for ordering example)		
Lockset with SFIC Core Prep (less core)	\$0.00	\$0.00
Lockset with Medeco®/ASSA® IC Core Prep (less core)	\$0.00	\$0.00
Lockset with Schlage® IC Core Prep (less core)	\$0.00	\$0.00
Lockset with Schlage® Standard Cylinder Prep (less cylinder)	\$38.00	\$0.00
Lockset with Schlage® "C" Keyway Cylinder (specify cylinder model number 2803-47L)	\$0.00	\$0.00
Lockset with Corbin Russwin "L4", Corbin "60", Russwin "D1", Sargent® "LA" or Schlage® "E" Keyway Cylinder. (specify cylinder model number 3803-47L x keyway)	—	\$24.00
SPECIAL STRIKES:		
371 Strike with 1", 1-1/2", 1-3/4" or 2" lip with box	—	\$2.00
ANSI Strike 497 with 1 -1/8", 1-1/2" or 1-3/4" lip	—	\$19.00
KNURLING: Available for all levers in 613E, 626 and BSP finishes only		
Outside (KNO) or Inside (KNI) Only	--	\$116.00
Both Sides (KNB)	--	\$232.00
ABRASIVE COATING:		
Outside (ABCO) or Inside (ABCI) Only	--	\$71.00
Both Sides (ABCB)	--	\$142.00
DOORS 1-3/4" THICK: Adjustable to 2" thick	—	STD
DOORS 1-3/8" OR 2-1/4" THICK:	—	\$4.00
MICROSHIELD®: Antimicrobial coating. Specify "YMS".	—	\$101.00

Note: Security and ACCENTRA KeyMark® Cylinders: see page 100 for pricing. These cylinders are priced and discounted separately.

4700LN SERIES GRADE 1 CYLINDRICAL LOCKS

LEVER DESIGN: Augusta-AU Pacific Beach - PB Monroe - MO Reflections® - TB, UB

MODEL #	PRODUCT DESCRIPTION	626	605 606 612 613E 619 625 BSP WSP
SINGLE CYLINDER:			
4704LN	Entry	\$604.00	\$620.00
4705LN	Storeroom or Closet		
4706LN	Service Station		
4707LN	Entry		
4708LN	Classroom		
4722LN	Corridor		
4729LN	Communicating Classroom		
4739LN	Communicating Storeroom		
DOUBLE CYLINDER:			
4718LN	Intruder Classroom Security	\$698.00	\$714.00
4721LN	Communicating		
4730LN	Utility, Asylum or Institutional		
NON-KEY LATCHSETS:			
4701LN	Passage or Closet	\$491.00	\$507.00
4709LN	Exit Latch	\$557.00	\$573.00
4702LN	Privacy, Bedroom or Bath		
4703LN	Patio or Privacy		
4725LN	Privacy		
4728LN	Communicating Passage	\$491.00	\$507.00
DUMMY TRIM			
4755LN	Single Dummy Trim	\$252.00	\$260.00
4755LN-D	Double Dummy Trim	\$504.00	\$520.00

CASE LOT: 10

SHIPPING WEIGHT: 4 Lbs. per lock

PRODUCT DESCRIPTION	AU	MO	PB	TB	UB	ALL FINISHES
LEVERS ONLY:						
Plain Inside	14-YM00-6040	14-5301-6902	14-5301-6054	14-5301-6201	14-5301-6301	\$88.00
Passage Outside	14-YM00-6040	14-5301-6902	14-5301-6054	14-5303-6201	14-5303-6301	
Patio Outside	14-YM00-6060	14-5303-6067	14-5303-6066	14-5303-6203	14-5303-6303	
Outside Emergency Key	14-YM00-6058	14-5302-6585	14-5302-6062	14-5302-6202	14-5302-6302	
Cylinder	14-YM00-6039	14-5305-6056	14-5305-6054	14-5300-6200	14-5300-6300	
Button	14-YM00-6039	14-5305-6056	14-5305-6054	14-5300-6200	14-5300-6300	
ACCENTRA LFIC 1-3/4" Door	14-YM00-6028	14-5305-0014	14-5305-0010	14-5305-6205	14-5305-6305	\$109.00
ACCENTRA LFIC 2-1/4" Door	14-YM00-6028	14-5305-6059	14-5305-6051	14-5305-6205	14-5305-6305	
SFIC 1-3/4" Door	14-YM00-6030	14-5305-0016	14-5305-0012	14-5305-6206	14-5305-6306	
SFIC 2-1/4" Door	14-YM00-6030	14-5305-6057	14-5305-6053	14-5305-6206	14-5305-6306	
Schlage® LFIC 1-3/4" Door	14-5305-6069	N/A	14-5305-0013	N/A	N/A	
Schlage® LFIC 2-1/4" Door	14-5305-6069		14-5305-6070	N/A	N/A	
ASSA/Medeco LFIC 1-3/4" Door	14-YM00-6031		N/A	N/A	N/A	

ELECTRIFIED 4700LN SERIES CYLINDRICAL LEVER LOCKS

DESIGNS: Augusta - AU Monroe - MO Pacific Beach - PB Reflections® - TB, UB

MODEL #	PRODUCT DESCRIPTION	626	605 606 612 613E 619 625 BSP WSP
CYLINDER OVERRIDE:			
4790LN	Fail Safe	\$944.00	\$960.00
4791LN	Fail Secure		
NO CYLINDER OVERRIDE:			
4780LN	Fail Safe	\$850.00	\$866.00
4781LN	Fail Secure		
LOCKBODIES:			
4780LN	Fail Safe	\$641.00	\$657.00
4781LN	Fail Secure		
4790LN	Fail Safe		
4791LN	Fail Secure		

CASE LOT: 10

SHIPPING WEIGHT: 4.8 Lbs. per lock

Note: See page 208 for power supplies and electrified accessories.

SFIC Core Prep: prefix "B" to trim designation. Accepts all SFIC cores, 6- or 7-Pin.

Example: B-AU4707LN x Less Core.

Medeco®/ASSA® IC Core Prep: prefix "M" to trim designation. Not Available with MO or PB Levers. 6-Pin only.

Example: M-AU4707LN x Less Core.

Schlage® IC Core Prep: prefix "SI" to trim designation. 6-Pin only.

Example: SI-AU4707LN x Less Core.

Schlage® Cylinder Prep: prefix "S" to trim designation. 6-Pin only.

Example: S-AU4707LN x Less Cylinder.

Lockset with Sargent® "LA" Keyway Cylinder. 6-Pin only.

Example: AU4707LN x 3803-47L x LA.

Lockset with Schlage® "C" Keyway Cylinder. 6-Pin only.

Example: AU4707LN x 2803-47L.

4700LN SERIES GRADE 1 CYLINDRICAL LOCKS

MODEL #	PRODUCT DESCRIPTION	ORDERED SEPARATELY	ORDERED WITH LOCKSET
PLAIN LATCHBOLTS:			
693	Beveled, 2-3/4" Backset, 1/2" Throw	\$109.00	STD
F693	Flat, 2-3/4" Backset, 1/2" Throw		N/C
3693	Beveled, 3-3/4" Backset, 1/2" Throw	\$117.00	\$7.00
DEADLOCKING LATCHBOLTS:			
694	Beveled, 2-3/4" Backset, 1/2" Throw	\$139.00	STD
F694	Flat, 2-3/4" Backset, 1/2" Throw		N/C
3694	Beveled, 3-3/4" Backset, 1/2" Throw	\$155.00	\$16.00
480B	Beveled, 2-3/4" Backset, 3/4" Throw	\$265.00	\$126.00
F480B	Flat, 2-3/4" Backset, 3/4" Throw		
3480B	Beveled, 3-3/4" Backset, 3/4" Throw	\$279.00	\$140.00
BACKSET LINKS:			
481	Extension Link	\$72.00	\$72.00
481DL	Extension Link (use with deadlocking latchbolts)		
482	Extension Link	\$98.00	\$98.00
484	Extension Link	\$214.00	\$214.00
STRIKES:			
202	Strike Box (Not Plated)	\$2.00	\$2.00
371	Strike 1-1/4" Lip with Box	\$12.00	N/C
371	Strike 1", 1-1/2", 1-3/4" or 2" Lip with Box	\$23.00	\$2.00
497	ANSI Strike Lip 1-1/4"	\$57.00	STD
497	ANSI Strike 1-1/8", 1-1/2" or 1-3/4" Lip	\$64.00	\$19.00

MODEL #	PRODUCT DESCRIPTION	ORDERED SEPARATELY	ORDERED WITH LOCKSET
CYLINDERS:			
1803-47L	Standard Cylinder 6-Pin	\$94.00	N/C
5803-47L	Security Cylinder 6-Pin	\$373.00	\$279.00
1210	Large Format Interchangeable Core Only 6-Pin	\$86.00	\$86.00
5210	Security Large Format Interchangeable Core Only 6-Pin	\$343.00	\$343.00
K402	ACCENTRA KeyMark® Cylinder 6-Pin	\$118.00	\$24.00
K800	ACCENTRA KeyMark® Large Format Interchangeable Core Only 6-Pin	\$126.00	\$126.00
K600	ACCENTRA KeyMark® Small Format Interchangeable Core Only 6- or 7-Pin	\$120.00	\$120.00
2803-47L	Schlage® "C" Keyway Cylinder 6-Pin 0-bitted or Keyed Random	\$94.00	N/C
3803-47L	Other Manuf. Keyway Cylinder 6-Pin - Keyed Random, Specify Keyway	\$118.00	\$24.00
A600	Best® Keyway Small Format Interchangeable Core Only 6- or 7-Pin, Specify Keyway	\$76.00	\$76.00
108S	Schlage® Cylinder Adapter Kit	\$28.00	\$28.00
9053	Cylinder Sleeve for K402 Cylinder	\$11.70	\$11.70
14-1803-9001	Cylinder Sleeve for 1803-47L/5803-47L Cylinders	\$11.70	N/C

4600LN & 4600YC GRADE 2 CYLINDRICAL LOCKS VARIATIONS

STANDARD FINISHES: Products will be furnished only in the following finishes.

LEVER	
ANSI/BHMA CODE	FINISH DESCRIPTION
BRASS:	
605	Bright Brass, Clear Coated
606	Satin Brass, Clear Coated
BRONZE:	
613E	Dark Oxidized Satin Bronze - equivalent
CHROME:	
625	Bright Chrome Plated
626	Satin Chrome Plated
PAINTED:	
BSP	Black Suede Powder Coat

KNOB	
ANSI/BHMA CODE	FINISH DESCRIPTION
BRASS:	
605	Bright Brass, Clear Coated
606	Satin Brass, Clear Coated
BRONZE:	
613E	Dark Oxidized Satin Bronze - equivalent
STAINLESS STEEL:	
629	Bright Stainless Steel
630	Satin Stainless Steel

PRODUCT OPTIONS	DEDUCT	ADD
CYLINDERS: 6-pin Only		
LESS CYLINDER OR LESS CORE:		
Standard cylinder prep only. Specify "x LC"	\$0.00	—
Small format interchangeable core prep less core, prefix "B" to trim and specify "Less Core"	—	\$0.00
Ordering Example: B-AU-4607LN x Less Core	—	—
CYLINDER OPTIONS:		
Lockset with Corbin Russwin "L4", Corbin "60", Russwin "D1", Sargent® "LA" or Schlage® "E" Keyway Cylinder. (specify cylinder model number 3806 x keyway)	—	\$24.00
Lockset with Schlage® "C" Keyway Cylinder	\$0.00	\$0.00
Lockset with A600 Best® Keyway Small Format Interchangeable Core	—	\$76.00
SPECIAL STRIKES:		
371 Strike with 1", 1-1/2", 1-3/4" or 2" lip with box	—	\$2.00
ANSI Strike 497 with 1-1/8", 1-1/2" or 1-3/4" lip	—	\$19.00
DOORS 1-3/4" THICK: Adjustable to 1-3/8" thick	—	STD
KNURLING: Not Available		
ABRASIVE COATING: (4600LN levers only)		
Outside (ABCO) or Inside (ABCI) Only	--	\$71.00
Both Sides (ABCB)	--	\$142.00

4600LN & 4600YC SERIES GRADE 2 CYLINDRICAL LOCKS



LEVER DESIGN: Augusta-AU Pacific Beach - PB Monroe - MO Reflections® - TB, UB

MODEL #	PRODUCT DESCRIPTION	626	605 606 613E 625 BSP
SINGLE CYLINDER:			
4604LN	Entry	\$167.00	\$183.00
4605LN	Storeroom or Closet		
4607LN	Entry		
4608LN	Classroom		
NON-KEY LATCHSETS:			
4601LN	Passage or Closet	\$146.00	\$162.00
4602LN	Privacy, Bedroom or Bath	\$148.00	\$164.00
4628LN	Communicating Passage		
DUMMY TRIM:			
4655LN	Single Dummy Trim	\$56.00	\$64.00

CASE LOT: 10
SHIPPING WEIGHT: 4 Lbs. per lock

KNOB DESIGN: Carolina-CA

MODEL #	PRODUCT DESCRIPTION	630	605 606 613E 629
SINGLE CYLINDER:			
4605YC	Storeroom or Closet	\$115.00	\$131.00
4607YC	Entry		
4608YC	Classroom		
NON-KEY LATCHSETS:			
4601YC	Passage or Closet	\$77.00	\$93.00
4602YC	Privacy, Bedroom or Bath	\$80.00	\$96.00
DUMMY TRIM:			
4655YC	Single Dummy Trim	\$48.00	\$56.00

CASE LOT: 10
SHIPPING WEIGHT: 2 Lbs. per lock

MODEL #	PRODUCT DESCRIPTION	ORDERED SEPARATELY	ORDERED WITH LOCKSET
STRIKES:			
70S	Full Lip Strike (Optional)	\$7.00	N/C
71S	1/4" Radius Full Lip Strike (Optional)		
202	Strike Box (Not Plated)	\$2.00	\$2.00
371	Strike 1-1/4" Lip with Box	\$12.00	N/C
371	Strike 1", 1-1/2", 1-3/4" or 2" Lip with Box	\$23.00	\$2.00
497	ANSI Strike Lip 1-1/4"	\$57.00	N/C
497	ANSI Strike 1-1/8", 1-1/2" or 1-3/4" Lip	\$64.00	\$19.00
*PLAIN LATCHBOLTS:			
MCP234	2-3/4" Backset, 2-1/4" x 1-1/8" Square Front	\$46.00	STD
MCP238	2-3/8" Backset, 2-1/4" x 1" Square Front		N/C
MCP238R	2-3/8" Backset, 2-1/4" x 1" Round Front		
*DEADLOCKING LATCHBOLTS:			
MCD234	2-3/4" Backset, 2-1/4" x 1-1/8" Square Front	\$55.00	STD
MCD238	2-3/8" Backset, 2-1/4" x 1" Square Front		N/C
MCD238R	2-3/8" Backset, 2-1/4" x 1" Round Front		

*All latches have universal fronts for both flat and beveled door edges.

MODEL #	PRODUCT DESCRIPTION	ORDERED SEPARATELY	ORDERED WITH LOCKSET
CYLINDERS:			
1805	Standard Cylinder 6-Pin for Knob Designs	\$80.00	N/C
1806	Standard Cylinder 6-Pin for Lever Designs		
2805	Schlage® "C" Keyway Cylinder 6-Pin 0-bitted or Keyed Random for Knob Designs		
2806	Schlage® "C" Keyway Cylinder 6-Pin 0-bitted or Keyed Random for Lever Designs		
3806	Other Manuf. Keyway Cylinder 6-Pin - Keyed Random, Specify Keyway for Knob/Lever Designs	\$104.00	\$24.00
A600	Best® Keyway Small Format Interchangeable Core Only 6- or 7-Pin, Specify Keyway	\$76.00	\$76.00

When Ordering: Specify design, function, hand and finish.

RL SERIES TUBULAR LOCKS VARIATIONS

STANDARD FINISHES: Product will be furnished only in the finishes in which it is priced.

ANSI/BHMA CODE	FINISH DESCRIPTION
BRASS:	
605	Bright Brass, Clear Coated
606	Satin Brass, Clear Coated
BRONZE:	
611	Bright Bronze, Clear Coated
612	Satin Bronze, Clear Coated
613E	Dark Oxidized Satin Bronze - equivalent
CHROME:	
625	Bright Chrome Plated
626	Satin Chrome Plated

ANSI/BHMA CODE	FINISH DESCRIPTION
NICKEL:	
618	Bright Nickel Plated, Clear Coated
619	Satin Nickel Plated, Clear Coated
STAINLESS STEEL:	
629	Bright Stainless Steel
630	Satin Stainless Steel
PAINTED:	
BSP	Black Suede Powder Coat
WSP	White Suede Powder Coat

PRODUCT OPTIONS	DEDUCT	ADD
UL 3-Hour Fire Rating - Suffix 'F' to model number. Available for RL201, RL202, RL228	–	\$11.00
STRIKES:		
ANSI Strike 497	–	\$4.00
DOOR THICKNESS:		
Adjustable 1-3/8" to 1-3/4"	–	STD
1-7/8" to 2" (latchbolt centered in total door thickness)	–	\$0.00
KNURLING: Not available.	–	STD
MICROSHIELD®: Antimicrobial coating. Specify option "YMS".	–	\$101.00
REFLECTION LEVERS: The following levers are no longer available in 629 and 630 finishes, TT, TU, TW, TX, TY, UX, TG, TJ, TK, TE, TI and TD.	–	–

LEVER DESIGNS: All Reflections® Designs

ROSE DESIGNS: R3, R4, R5, R9

MODEL #	PRODUCT DESCRIPTION	613E 626 BSP WSP	605 606 611 612 618 619 625 629' 630'
RL201	Passage or Closet	\$322.00	\$332.00
RL228	Communicating Passage Exit Latch		
RL202	Privacy, Bedroom or Bath	\$334.00	\$344.00
RL255	Single Dummy Trim - Through-Bolted	\$180.50	\$185.50
RL255D	Double Dummy Trim	\$293.00	\$303.00
RL255S	Single Dummy Trim - Surface Mounted	\$146.50	\$151.50

PARTS:

MODEL #	PRODUCT DESCRIPTION	ORDERED SEPARATELY	ORDERED WITH LOCKSET
STRIKES:			
202	Strike Box (Not Plated)	\$2.00	\$2.00
70S	Full Lip Strike	\$7.00	N/C
71S	1/4 Radius Full Lip Strike		
371	Strike 1-1/4" Lip with Box	\$12.00	N/C
371	Strike 1", 1-1/2", 1-3/4" or 2" Lip with Box	\$23.00	\$2.00
497	ANSI Strike Lip 1-1/4"	\$57.00	\$4.00
497	ANSI Strike with 1-1/8", 1-1/2" or 1-3/4" Lip	\$64.00	\$19.00
LATCHBOLTS:			
RLP34	Square Corner Front 2-1/4" x 1-1/8" Faceplate, used with RL202	\$54.00	STD
RLP34A	Square Corner Front 2-1/4" x 1-1/8" Faceplate, used with RL201 & RL228		
RLP38	Square Corner Front 2-1/4" x 1" Faceplate, used with RL202		
RLP38A	Square Corner Front 2-1/4" x 1" Faceplate, used with RL201 & RL228		
RLPR34	Round Corner Front 2-1/4" x 1-1/8" Faceplate, used with RL202		
RLPR34A	Round Corner Front 2-1/4" x 1-1/8" Faceplate, used with RL201 & RL228		
RLPR38	Round Corner Front 2-1/4" x 1" Faceplate, used with RL202		
RLPR38A	Round Corner Front 2-1/4" x 1" Faceplate, used with RL201 & RL228		
1. See the Variations page for details.			

STANDARD FINISHES: Product will be furnished only in the finishes in which it is priced. Finishes do not apply to Padlocks or Auxiliary Locks.

ANSI/BHMA CODE	FINISH DESCRIPTION
BRASS:	
605	Bright Brass, Clear Coated
606	Satin Brass, Clear Coated
BRONZE:	
612	Satin Bronze, Clear Coated
613E	Dark Oxidized Satin Bronze - equivalent

ANSI/BHMA CODE	FINISH DESCRIPTION
CHROME:	
625	Bright Chrome Plated
626	Satin Chrome Plated
NICKEL:	
619	Satin Nickel Plated, Clear Coated
PAINTED:	
BSP	Black Suede Powder Coat

D100 AND D200 SERIES DEADBOLTS

PRODUCT OPTIONS	DEDUCT	ADD
CYLINDERS: 6-pin Only		
LESS CYLINDER OR LESS CORE:		
Standard cylinder prep less cylinder, specify "x LC"	\$0.00	\$0.00
Large format interchangeable core prep less core, for 6-pin, specify "x ICLC" Ordering Example: D112 x 1210 Prep x Less Core (available for D100 or D200 series)	\$0.00	\$0.00
Small format interchangeable core prep less core, for 6-or 7-pin, specify with "B" prefix "x Less Core" Ordering Example: B-D112 x Less Core (available for D100 or D200 series)	\$0.00	\$0.00
7-PIN (available for SFIC and LFIC - for LFIC, specify "x 1220"):		
Add to 6-Pin core	—	\$2.00
INTERCHANGEABLE CORES:		
1210 - LFIC 6-Pin (available for D100 series - includes MK or GMK) Ordering Example: D112 x 1210 x 626	—	\$86.00
1210 - LFIC 6-Pin (available for D200 series - includes MK or GMK) Ordering Example: D212 x 1210 x 626	—	\$86.00
A600 Best® Keyway SFIC 6-or 7-Pin (available for D100 or D200 series - includes MK or GMK) Ordering Example: B-D112 x A600 x 626	—	\$76.00
CYLINDER OPTIONS:		
Deadbolt with Schlage® "C" Keyway Cylinder	\$0.00	\$0.00
Deadbolt with Corbin Russwin "L4", Corbin® "60", Russwin® "D1", Sargent® "LA" or Schlage "E"	—	\$24.00
DOORS 1-3/4" THICK: Adjustable to 1-3/8" thick	—	STD
INDICATOR OPTIONS:		
V01 - Indicator inside only "Unlocked/Locked" in green/red	—	\$36.00
V04 - Indicator inside only "Unlocked/Locked" in white/red	—	
V01F - Indicator inside only, French "Ouvert/Fermé" in green/red	—	
V21 - Indicator both sides "Unlocked/Locked" x "Vacant/Occupied" in green/red (Std for D291/D292)	—	\$0.00
V54 - Indicator both sides "Unlocked/Locked" x "Vacant/Occupied" in white/red	—	
V21F - Indicator both sides, French "Ouvert/Fermé" x "Libre/Occupée" in green/red	—	

When Ordering: Specify finish.

D100 AND D200 SERIES DEADBOLTS

D100 GRADE 1 DEADBOLTS

MODEL #	BACKSET	FRONT	613E 626 BSP	605 606 612 619 625	APPROX. SHIPPING WT. LBS.
CYLINDER x THUMBTURN:					
D111	2-3/8"	2-1/4" X 1"	\$236.00	\$240.00	24
D112	2-3/4"	2-1/4" X 1"			
B-D171	2-3/8"	2-1/4" X 1"			
B-D172	2-3/4"	2-1/4" X 1"			
CYLINDER x CYLINDER:					
D121	2-3/8"	2-1/4" X 1"	\$291.00	\$295.00	24
D122	2-3/4"	2-1/4" X 1"			
CYLINDER x BLANK ROSE:					
D131	2-3/8"	2-1/4" X 1"	\$236.00	\$240.00	24
D132	2-3/4"	2-1/4" X 1"			
BLANK PLATE x THUMBTURN:					
D141	2-3/8"	2-1/4" X 1"	\$189.00	\$193.00	24
D142	2-3/4"	2-1/4" X 1"			
BLANK PLATE x CYLINDER					
D151	2-3/8"	2-1/4" X 1"	\$236.00	\$240.00	24
D152	2-3/4"	2-1/4" X 1"			
CYLINDER x CLASSROOM THUMBTURN					
D161	2-3/8"	2-1/4" X 1"	\$248.00	\$252.00	24
D162	2-3/4"	2-1/4" X 1"			
B-D181	2-3/8"	2-1/4" X 1"			
B-D182	2-3/4"	2-1/4" X 1"			

D200 GRADE 2 DEADBOLTS

MODEL #	BACKSET	FRONT	613E 626 BSP	605 606 612 619 625	APPROX. SHIPPING WT. LBS.
CYLINDER x THUMBTURN:					
D211	2-3/8"	2-1/4" X 1"	\$128.00	\$132.00	24
D212	2-3/4"	2-1/4" X 1"			
CYLINDER x CYLINDER:					
D221	2-3/8"	2-1/4" X 1"	\$172.00	\$176.00	24
D222	2-3/4"	2-1/4" X 1"			
CYLINDER x BLANK ROSE:					
D231	2-3/8"	2-1/4" X 1"	\$128.00	\$132.00	24
D232	2-3/4"	2-1/4" X 1"			
BLANK PLATE x THUMBTURN:					
D241	2-3/8"	2-1/4" X 1"	\$72.00	\$76.00	24
D242	2-3/4"	2-1/4" X 1"			
BLANK PLATE x CYLINDER					
D251	2-3/8"	2-1/4" X 1"	\$128.00	\$132.00	24
D252	2-3/4"	2-1/4" X 1"			
CYLINDER x CLASSROOM THUMBTURN					
D261	2-3/8"	2-1/4" X 1"	\$139.00	\$143.00	24
D262	2-3/4"	2-1/4" X 1"			
THUMBTURN X INDICATOR*					
D291	2-3/8"	2-1/4" X 1"	\$112.00	\$116.00	24
D292	2-3/4"	2-1/4" X 1"			

NOTE: 1-1/8" front filler supplied standard with each deadbolt.

*Indicator option code MUST be specified when ordering D291 or D292. If none specified, V21 will be provided as default.

Case Lot: 12

When Ordering: Specify function and finish.

D100 AND D200 SERIES PARTS AND ACCESSORIES

MODEL #	PRODUCT DESCRIPTION	ORDERED SEPARATELY	ORDERED WITH LOCKSET
CYLINDERS:			
1807	Standard Cylinder 6-pin for use with DX11, DX12, DX31, DX32, DX51, DX52, DX61, DX62	\$80.00	N/C
1808	Standard Cylinder 6-pin for use with DX21, DX22		
2807	Schlage® "C" Keyway Cylinder 6-Pin - 0-bitted or Keyed Random for use with DX11, DX12, DX31, DX32, DX51, DX52, DX61, DX62		
2808	Schlage® "C" Keyway Cylinder 6-Pin - 0-bitted or Keyed Random for use with DX21, DX22		
3806	Other Manuf. Keyway Cylinder 6-Pin - Keyed Random, Specify Keyway for D Series	\$104.00	\$24.00
1210	Large Format Interchangeable Core Only 6-Pin	\$86.00	\$86.00
1220	Large Format Interchangeable Core Only 7-Pin	\$88.00	\$88.00
5210	Security Large Format Interchangeable Core Only 6-Pin	\$343.00	\$343.00
5220	Security Large Format Interchangeable Core Only 7-Pin	\$347.00	\$347.00
K800	ACCENTRA KeyMark® Large Format Interchangeable Core Only 6-or 7-Pin	\$126.00	\$126.00
K600	ACCENTRA KeyMark® Small Format Interchangeable Core Only 6-or 7-Pin	\$120.00	\$120.00
A600	Best® Keyway Small Format Interchangeable Core Only 6- or 7-Pin, Specify Keyway	\$76.00	\$76.00

NOTE: X in model number = '1' for Grade 1 and '2' for Grade 2

MODEL #	PRODUCT DESCRIPTION	ORDERED SEPARATELY	ORDERED WITH LOCKSET
DEADBOLT ASSEMBLIES:			
D38	2-3/8" Backset, 2-1/4" x 1" Square Front, includes 1-1/8" Front Filler	\$17.00	N/C
D34	2-3/4" Backset, 2-1/4" x 1" Square Front, includes 1-1/8" Front Filler		
D38R	2-3/8" Backset, 2-1/4" x 1" Radius Front		
D34R	2-3/4" Backset, 2-1/4" x 1" Radius Front		
STRIKES:			
D243	Strike pack which includes 2-3/4" x 1-1/8" both wood and metal frame strikes and corresponding screws	\$4.00	STD
D244	Strike Reinforcement	\$3.00	

When Ordering: Specify function and finish.

STANDARD FINISHES: Product will be furnished only in the finishes in which it is priced. Finishes do not apply to Padlocks or Auxiliary Locks.

ANSI/BHMA CODE	FINISH DESCRIPTION
BRASS:	
605	Bright Brass, Clear Coated
606	Satin Brass, Clear Coated
BRONZE:	
611	Bright Bronze, Clear Coated
612	Satin Bronze, Clear Coated
613E	Dark Oxidized Satin Bronze - equivalent
CHROME:	
625	Bright Chrome Plated
626	Satin Chrome Plated

ANSI/BHMA CODE	FINISH DESCRIPTION
NICKEL:	
618	Bright Nickel Plated, Clear Coated
619	Satin Nickel Plated, Clear Coated
STAINLESS STEEL:	
629	Bright Stainless Steel
630	Satin Stainless Steel
PAINTED:	
693	Black Painted
BSP	Black Suede Powder Coat

350 SERIES DEADLOCKS & PADLOCKS

PRODUCT OPTIONS	DEDUCT	ADD
CYLINDERS OMITTED 350 SERIES ONLY:	\$108.00	
IC Housing ordered with 350 Series	\$0.00	\$0.00
DUST GUARD: For cylinders prefix "D" to model number (refer to catalog)	—	\$72.00
7-PIN CYLINDERS AND LFIC CORES:	—	\$2.00
INTERCHANGEABLE CORE CYLINDERS:		
2196 - LFIC 6-Pin (includes MK or GMK) Ordering Example: 353 x 2196 x 626	—	\$86.00
A620 - SFIC 6-or 7-Pin (Includes MK or GMK) Ordering Example: 353 x A620 x 626	—	\$76.00
SECURITY SCREWS 300 SERIES: Standard sizes only (each screw)	—	\$1.00
SPLIT FINISHES: Higher List Price Applies		
LEAD LINED 350 SERIES:	—	\$277.00
MICROSHIELD®: Antimicrobial coating. Specify "YMS".	—	—
Mortise Deadlocks	—	\$101.00
SPECIAL STRIKES: (For Use with YSSL10)		
371 Strike with 1", 1-1/2", 1-3/4" or 2" lip with box	—	\$2.00

When Ordering: Specify finish.

350 SERIES MORTISE DEADLOCKS

MODEL #	PRODUCT DESCRIPTION	613E 626 BSP	605 606 611 612 618 619 625 629 630 693
350 SERIES DEADLOCKS:			
351	Double Cylinder	\$546.00	\$551.00
352	Single Cylinder Outside x Thumbturn Inside	\$488.00	\$493.00
353	Single Cylinder Outside	\$438.00	\$443.00
354	Exit (Thumbturn Inside Only)	\$380.00	\$385.00
356	Double Cylinder with Thumbturn Inside	\$596.00	\$601.00
357	Single Cylinder Outside x Thumbturn Inside	\$488.00	\$493.00

MODEL #	PRODUCT DESCRIPTION	ORDERED WITH LOCKSET	ORDERED SEPARTELY
THUMBTURNS AND STRIKES:			
1827	Thumbturn for 352, 354, 356 & 357	N/C	\$85.00
30S	Strike 3-1/2" x 1-1/8" (standard)	STD	\$50.00
545N	Strike 4-7/8" x 1-1/4" (optional)	N/C	\$35.00
31S	Strike Box - not plated (optional)	\$2.00	\$2.00

AUXILIARY LATCH

MODEL #	PRODUCT DESCRIPTION	605 606 612 625 626
AUXILIARY LATCH:		
YSSL10	Security SideLite Auxiliary Latch	\$213.00

When Ordering: Specify finish.

AUXILIARY LOCKS

MODEL #	PRODUCT DESCRIPTION	PRICE EACH	CASE LOT	APPROX. SHIPPING WT.
AUXILIARY RIM LOCKS:				
88	Auxiliary Security Latchlock	\$104.00	30	35
80	Auxiliary Security Latchlock		30	49
*112	Auxiliary Heavy-Duty Deadbolt	\$172.00	6	12-1/2
*112 1/4	Auxiliary Heavy-Duty Deadbolt	\$202.00	6	14
*197	Auxiliary Jimmy-Proof Deadlock	\$172.00	6	12-1/2
*197 1/4	Auxiliary Jimmy-Proof Deadlock	\$202.00	6	14

*Add suffix "F" for doors opening outward.

SHELF BOX: 1

NOTE: Standard cylinders included with auxiliary locks are supplied PARA Keyed Different. No deduct for omitting cylinder.

MODEL #	PRODUCT DESCRIPTION	PRICE EACH
STRIKES:		
8RB	Reverse Bevel Strike (for use with 80, 88)	\$63.00
112FS	Strike (for use with 112)	\$27.00
197FS	Flat Strike (for use with 197, 197 1/4)	\$46.00

VISUAL PACK AUXILIARY LOCKS

MODEL #	PRODUCT DESCRIPTION	PRICE EACH	CASE LOT	APPROX. SHIPPING WT.
AUXILIARY RIM LOCKS:				
V80	Auxiliary Security Latchlock	\$104.00	5	17
V197	Auxiliary Jimmy-Proof Deadlock	\$172.00	5	12

NOTE: Standard cylinders included with auxiliary locks are supplied PARA Keyed Different. No deduct for omitting cylinder.

When Ordering: Specify function and finish.

PADLOCKS PD400 SERIES

MODEL #	DESCRIPTION	KEYED ALIKE / KEYED DIFFERENT
FIXED CORE:		
PD416	6-Pin, 5/16" Diameter Shackle	\$108.00
PD2416	6-Pin, 5/16" Diameter & 2" Extended Shackle	\$113.00
PD3416	6-Pin, 5/16" Diameter & 3" Extended Shackle	\$116.00

OPTIONS			
Chain attached to shackle			
Steel (Suffix "S42S" to model number)	ADD		\$6.80
Brass (Suffix "S42A" to model number)	ADD		\$8.00
Brass Shackles (Suffix "B" to model number)	ADD		\$6.80
Master Keyed	ADD		\$16.00

NOTE: Padlocks operated by two (2) or more different keys same price as master keying. Furnished standard keyed different with 1801 cylinder. See pages 32, 37 and 44 for optional 2801, 5801 or K400 cylinder pricing.

When Ordering: Specify design, hand and finish.

INTERCHANGEABLE CORE:

MODEL #	DESCRIPTION	LESS CORE	CASE LOT	SHIPPING WT. LBS.
LFIC PADLOCKS				
PD514	6-Pin, 5/16" Diameter Shackle	\$170.00	20	19
PD524	6-Pin, 3/8" Diameter Shackle			
PD534	7-Pin, 3/8" Diameter Shackle	\$172.00	18	17
PD2514	6-Pin, 5/16" Diameter & 2" Extended Shackle			
PD2524	6-Pin, 3/8" Diameter & 2" Extended Shackle	\$174.00	18	19
PD2534	7-Pin, 3/8" Diameter & 2" Extended Shackle			
PD3514	6-Pin, 5/16" Diameter & 3" Extended Shackle	\$176.00	18	19
PD3524	6-Pin, 3/8" Diameter & 3" Extended Shackle			
PD3534	7-Pin, 3/8" Diameter & 3" Extended Shackle			
SFIC PADLOCKS:				
PD515	6- or 7-Pin, 5/16" Diameter Shackle	\$80.00	20	19
PD525	6- or 7-Pin, 3/8" Diameter Shackle			
PD2515	6- or 7-Pin, 5/16" Diameter & 2" Extended Shackle	\$82.00	18	19
PD2525	6- or 7-Pin, 3/8" Diameter & 2" Extended Shackle			
PD3515	6- or 7-Pin, 5/16" Diameter & 3" Extended Shackle	\$84.00	18	19
PD3525	6- or 7-Pin, 3/8" Diameter & 3" Extended Shackle			

NOTE: LFIC and SFIC Padlocks furnished standard less core. Add master keyed core price when ordered with core. See pages 35 and 44 for available core pricing.

FIXED CORE:

MODEL #	DESCRIPTION	KEYED ALIKE / KEYED DIFFERENT	CASE LOT	SHIPPING WT. LBS.
FIXED CORE PADLOCKS				
PD516	6-Pin, 5/16" Diameter Shackle	\$173.00	20	19
PD526	6-Pin, 3/8" Diameter Shackle			
PD2516	6-Pin, 5/16" Diameter & 2" Extended Shackle	\$177.00	18	19
PD2526	6-Pin, 3/8" Diameter & 2" Extended Shackle			
PD3516	6-Pin, 5/16" Diameter & 3" Extended Shackle	\$181.00	18	19
PD3526	6-Pin, 3/8" Diameter & 3" Extended Shackle			

NOTE: Fixed core padlocks are 6-pin and furnished standard keyed different with 1801 cylinder. See pages 32, 37 and 44 for optional 2801, 5801 or K400 cylinder pricing.

OPTIONS			
Chain attached to shackle			
Steel (Suffix "S42S" to model number)		ADD	\$6.80
Brass (Suffix "S42A" to model number)		ADD	\$8.00
Chain attached to case			
Steel (Suffix "C42S" to model number)		ADD	\$6.80
Brass (Suffix "C42A" to model number)		ADD	\$8.00
Brass Shackles (Suffix "B" to model number)		ADD	\$6.80
PD516 or PD526 x Less Cylinder		DEDUCT	\$94.00
PD516 or PD526 x MK		ADD	\$16.00

NOTE: Padlocks operated by two (2) or more different keys same price as master keying.

PADLOCKS PD600 SERIES

MODEL #	DESCRIPTION	KEYED ALIKE / KEYED DIFFERENT
FIXED CORE:		
PD616	6-Pin, 5/16" Diameter Shackle	\$173.00
PD2616	6-Pin, 5/16" Diameter & 2" Extended Shackle	\$177.00

OPTIONS			
Chain attached to shackle			
Steel (Suffix "S42S" to model number)	ADD		\$6.80
Brass (Suffix "S42A" to model number)	ADD		\$8.00
Chain attached to case			
Steel (Suffix "C42S" to model number)	ADD		\$6.80
Brass (Suffix "C42A" to model number)	ADD		\$8.00
Master Keyed	ADD		\$16.00

NOTE: Padlocks operated by two (2) or more different keys same price as master keying. Furnished standard keyed different with 1801 cylinder. See pages 32, 37 and 44 for optional 2801, 5801 or K400 cylinder pricing.

MODEL #	LIST PRICE	CASE LOT	APPROX. SHIPPING WT.
CHAINS:			
42A	\$8.00	12	3/4
42S	\$6.80	12	3/4

When Ordering: Specify function and finish.

7000 SERIES EXIT DEVICES

VARIATIONS: Exit Devices and Trims are priced separately. In order to determine the full list price of a 7000 Series Exit Device with trim, it is necessary to add the list price of the device model number and the list price of the trim model number.

STANDARD FINISHES: Products will be furnished only in the following finishes.

ANSI/BHMA CODE	FINISH DESCRIPTION
BRASS:	
605	Bright Brass, Clear Coated
606	Satin Brass, Clear Coated
BRONZE:	
611	Bright Bronze, Clear Coated
612	Satin Bronze, Clear Coated
613E	Dark Oxidized Satin Bronze - equivalent

ANSI/BHMA CODE	FINISH DESCRIPTION
CHROME:	
625	Bright Chrome Plated (540F Series Trim Only)
626	Satin Chrome Plated (trim only)
NICKEL:	
619	Satin Nickel Plated, Clear Coated
STAINLESS STEEL:	
629	Bright Stainless Steel
630	Satin Stainless Steel
PAINTED:	
693	Black Painted
BSP	Black Suede Powder Coat
WSP	White Suede Powder Coat

CYLINDERS: Standard 6-Pin cylinders included with 540F Series Rose Trim only. All other keyed trim priced less cylinder, the list price of the cylinder must be added if cylinders are required. Specify cylinder and cylinder collar with collar size.

PRODUCT OPTIONS	ADD
DESIGNER LEVER: (HA)	\$360.00
DUST GUARD: Prefix "D" to model number (refer to Cylinders/Keys catalog for available cylinders)	\$72.00
DOOR WIDTH:	
24" Door Width (Suffix -24) See note 4 page 116.	\$0.00
30"-36" Door Width (Suffix -36)* Refer to the 7000 Series catalog for sizing capabilities.	STD
36"-48" Door Width (Suffix -48)* Refer to the 7000 Series catalog for sizing capabilities.	\$74.00
Door thickness: Doors over 2-1/4"	\$64.00
SLEEVE NUTS: Factory orders only for exact quantity	
SN-104 (For interlock bracket on fire-rated mullions)	\$4.00
SN-134 (4 Pack)	\$9.70
TORX® SECURITY HEAD SCREWS: Standard size only	
Rim Exit Device	\$57.00
UL Rim Exit Device	
Surface Vertical Rod Exit Device (SVR)	\$149.00
Concealed Vertical Rod Exit Device (CVR)	\$57.00
Mortise Exit Device	\$103.00
630F, 660F, 670F Series Trim	\$7.00
121NL, 350F, 540F, 620F, 650F, 680F, 690F Series Trim	N/A
ABRASIVE COATING: On Touchbar Pad (ABCI)	\$114.00
KNURLING:	
On Touch Pad, available in all finishes (KNI)	\$219.00
For outside trim (KNO)	\$116.00
MICROSHIELD®: Antimicrobial coating. Suffix YMS to model number for each exit device or trim that the coating will be applied.	\$119.00
REFLECTION LEVERS: The following levers are no longer available in 629 and 630 finishes, TT, TU, TW, TX, TY, UX, TG, TJ, TK, TE, TI and TD.	—

*Delayed Egress "D": Option -48 fits doors 41"-48". Devices cannot be cut less than 41".

7	X	X	X	Suffix	Size	Design	Trim	Finish	Other Info.
	Second Digit: "1" Standard device, 4-1/2" (114mm) or wider door stile. "2" Narrow stile door or narrow escutcheon trim (500F, 510F Series)	Third Digit: "0" Rim Device, Pullman Latch "1" SVR Device up to 8' "2" CVR Device, Metal Doors up to 8' "3" Mortise Device "5" SquareBolt®, Rim Security "6" CVR Device over 8', wood door or LBR "7" SVR Device over 8' or LBR	Fourth Digit: "0" Standard "5" Cylinder Dogging (Not with suffix "F")	Mechanical Feature "F" - Fire Exit Device "M" - Narrow escutcheon Trim in 4-1/2" (114mm) or wider door stile "LBR" - Less Bottom Rod (Note 2) "K5" - Mortise Device, EO or Entry by Key with/ without Rigid Knob. "K8" - Mortise Device, Entry by Knob "L5" - Mortise Device, Entry by Key with/ without Rigid Lever. (Note 1) "L8" - Mortise Device, Entry by Lever "T5" - Mortise Device with Thumbpiece Trim "T8" - Mortise Device, Active Thumbpiece Trim "2" - Double Cylinder Device (Note 3) "WS" - Windstorm Certified Products (Note 5, 6, 7) 5CH - 5lb pressure release (Note 8) ELECTRICAL FEATURE "-A" - Alarm Kit "-B" - Bar Monitor or Signaling "-D" - Delayed Egress "-O" - Outside Trim Monitor or Signaling "MELR" - Motor Latch Retraction "-S" - Bolt Status Monitor or Signaling "-Safe" - Mortise Device Trim Control (Lever Only) "-Secure" - Mortise Device Trim Control (Lever Only)	Size: DOW - (Door Opening Width) "24" 24" DOW "36" 30" to 36" DOW "48" 36" to 48" DOW Door Height: -8 = 8' (2.44m) -9 = 9' (2.74m) -10 = 10' (3.05m)	Trim Design (Lever or knob only)	Trim Model Number	See Page 115	Other Information: Door Hand RHR or LHR Door Thickness Over 1-3/4" (45mm) Fastener Options TORX® Security Screws SNB (wood, composite, or unreinforced metal doors) Specialty Cylinders & components

NOTES:





- Required for electrical feature, Suffix "-SAFE" or "-SECURE".
- LBR available on 7160(F90) and 7170(F90) devices only.
- For double cylinder devices, suffix "-2" after fourth digit.
- If "-24" device is to be used with a DOW greater than 24", the device will ship without UL label. The 12" touchpad will not cover 50% of the device touchbar length.
- "WS" applies only to 7150(F), 7250M(F) and 7170(F) devices.
- Maximum opening size 8'0" x 8'0".
- Contact Ceco, Curries® or Fleming for detailed frame/door requirements and limitations.
- 5CH applies to 7100 Rim devices only.

MAX. OPENING	DOOR TYPE	FIRE RATING	MODEL NO.	STYLE	STRIKE
SURFACE VERTICAL ROD (2 point latch):					
4' x 10'	Metal or Wood	None	7110	Wide	Surface
8' x 8'	Metal or Wood	3 Hour "A"	7110F	Wide	Surface
4' x 10'	Metal or Wood	None	7210M	Wide	Surface
8' x 8'	Metal or Wood	3 Hour "A"	7210MF	Wide	Surface
4' x 10'	Alum/Metal	None	7210	Narrow	Surface
4' x 10'	Metal or Wood	None	7170	Wide	Surface
8' x 10'	Metal or Wood	1-1/2 Hour "B"	7170F90	Wide	Surface
CONCEALED VERTICAL ROD (2 point latch):					
4' x 10'	Metal	None	7120	Wide	Surface
8' x 8'	Metal	3 Hour "A"	7120F	Wide	Surface
4' x 10'	Metal or Wood	None	7160	Wide	Mortise
8' x 10'	Metal or Wood	1-1/2 Hour "B"	7160F90	Wide	Mortise
4' x 10'	Metal or Wood	None	7220M	Wide	Surface
8' x 8'	Metal	3 Hour "A"	7220MF	Wide	Surface
4' x 10'	Alum/Metal	None	7220	Narrow	Surface



- NOTE:** Height must be specified when ordering Vertical Rod Exit Devices.
- "-7" Openings up to 7' - Standard on 7110(F), 7210, 7210M(F), 7170 SVR.
 - "-8" Openings 7' to 8' - Optional on SVR. Std on 7120(F), 7220, 7220M(F), 7160
 - "-9" Openings 8' to 9' - Optional on 7170(F90), 7160(F90) CVR only.
 - "-10" Openings 9' to 10' - Optional on 7170(F90), 7160(F90) CVR only.

When Ordering: Specify design, hand and finish.

MECHANICAL OPTIONS

OPTION	DESCRIPTION	LIST PRICE ADD
BPL	Bottom Pullman Latch. Suffix BPL to 7110, 7120, 7160, 7170, 7210, 7210M, 7220 & 7220M Panic Rated surface vertical rod exits.	\$47.00
LBR	Less Bottom Rod. Suffix LBR to 7160 & 7170 series only.	\$0.00
LUM	Lumi-Lite® Photoluminescence Powder Coat. Suffix LUM to 7000 Series touchpad cover only.	\$627.00
WS	Windstorm certified. Suffix WS to 7150, 7170, 7250M series exits.  Hurricane	\$167.00
YMS	MicroShield® antimicrobial coating. Suffix YMS to model number for each exit device or trim that the coating will be applied.	\$119.00
Cylinder Dogging	Inside cylinder dogging for Panic Rated Exits only. Change fourth digit of model number from "0" to "5". (Less cylinder)	\$138.00
Door Height over 8' to 10'	See catalog	\$156.00
5CH	5LB pressure release. Applies to 7100 Rim devices only.	\$40.00
988Y	12" Surface Bolt Kit - For Approved Windstorm Code Application - bring zinc plated finish  Hurricane	\$225.00
988Y-1	18" Surface Bolt Kit - For Approved Windstorm Code Application - bring zinc plated finish  Hurricane	
988Y-2	24" Surface Bolt Kit - For Approved Windstorm Code Application - bring zinc plated finish  Hurricane	

7100 SERIES EXIT DEVICES

MODEL #	PRODUCT DESCRIPTION	605 606 611 612 613E 619 629 630 693 BSP WSP
RIM:		
7100	Panic Rated	\$2,255.00
7100-2^	Panic Rated Double Cylinder	\$2,525.00
7100F	Fire Rated	\$2,507.00
7100F-2^	Fire Rated Double Cylinder	\$2,777.00
SQUAREBOLT®:		
7150	Panic Rated	\$2,343.00
7150-2^	Panic Rated Double Cylinder	\$2,613.00
7150WS	Panic Rated Windstorm Certified  Hurricane	\$2,510.00
7150F	Fire Rated	\$2,595.00
7150F-2^	Fire Rated Double Cylinder	\$2,865.00
7150FWS	Fire Rated Windstorm Certified  Hurricane	\$2,762.00
SURFACE VERTICAL ROD:		
7110	Panic Rated	\$3,021.00
7110F	Fire Rated	\$3,287.00
7170	Panic Rated	\$3,093.00
7170WS*	Panic Rated Windstorm Certified  Hurricane	\$3,260.00
7170F	Fire Rated	\$3,359.00
7170FWS*	Fire-Rated Windstorm Certified  Hurricane	\$3,526.00
CONCEALED VERTICAL ROD:		
7120	Panic Rated	\$3,122.00
7120F	Fire Rated	\$3,374.00
7160	Panic Rated	\$3,249.00
7160F	Fire Rated	\$3,501.00

*Not approved for LBR

^Handed unit, handing must be specified

When Ordering: Specify width, hand and finish.
Specify height for vertical rods.

TRIM
FOR 7100 SERIES RIM, SQUAREBOLT® , SVR, CVR EXITS
(ALL TRIMS PRICED LESS CYLINDER)

MODEL #	PRODUCT DESCRIPTION	All Finishes
*121NL	Nightlatch Trim	\$85.00

Not recommended for VR exit devices. See page 127 for cylinder options.

ROSE TRIMS
FOR 7100 SERIES RIM, SQUAREBOLT® , SVR, CVR EXITS
(STANDARD CYLINDERS INCLUDED)

MODEL #	PRODUCT DESCRIPTION	689 691 695	605 606 612 613E 619 625 626 693 BSP WSP
541F	AU-MO-PB Key-In-Lever – Nightlatch	\$658.00	\$684.00
546F	AU-MO-PB Key-In-Lever – Classroom		
548F	AU-MO-PB Active Lever – Dummy Free Wheeling	\$564.00	\$590.00
549F	AU-MO-PB Rigid Lever – Dummy Rigid		

Heavy-duty 600F Trim required for 7160 CVR Series escutcheon applications. 540F Rose Trim available.

OPTIONS			
B-	Prefix for SFIC core prep Key-In-Lever Trim Available with AU, MO, and PB levers.	ADD	\$0.00
M-	Prefix for Medeco®/ASSA® IC Core Prep Key-In-Lever Trim Available with AU levers.		\$0.00
S-	Prefix for Schlage® cylinder prep Key-In-Lever Trim Available with AU, MO, and PB levers.		\$0.00
SI-	Prefix for Schlage® IC Core Prep Key-In-Lever Trim. Available with AU, MO, and PB levers.		

NOTE: See Page 126 for other cylinder options.

When Ordering: Specify design and finish.

**HEAVY-DUTY ESCUTCHEON TRIMS
 FOR 7100 SERIES RIM, SQUAREBOLT® , SVR, CVR EXITS
 (ALL TRIMS PRICED LESS CYLINDER)**

MODEL #	PRODUCT DESCRIPTION	605 626'	606 629'	611 ² 630'	612 693	613E BSP	619 WSP
620F	Blank Escutcheon – Exit Only-Lever/Knob Prep						\$518.00
626F	Lever x Escutcheon x Cylinder – Classroom/Storeroom AR-AU-CR-JN-MO-PB-PN-VI-HA*						\$749.00
627F	Lever x Escutcheon x Cylinder – Nightlatch AR-AU-CR-JN-MO-PB-PN-VI-HA*						
628F	Lever x Escutcheon – Passage and Dummy Free Wheeling AR-AU-CR-JN-MO-PB-PN-VI-HA*						
629F	Lever x Escutcheon – Dummy Rigid AR-AU-CR-JN-MO-PB-PN-VI-HA*						
632F	Pull x Escutcheon x Cylinder – Nightlatch						\$518.00
633F	Pull x T.P. x Escutcheon x Cylinder – Classroom/Storeroom						\$653.00
634F	Pull x Escutcheon – Dummy						\$518.00
635F	Pull x T.P. x Escutcheon – Dummy/T-Piece						\$653.00

*See the Variations page for HA price add.

WITH REFLECTIONS® LEVER DESIGNS:

MODEL #	PRODUCT DESCRIPTION	605 626'	606 629'	611 630'	612 693	613E BSP	619 WSP
626F	Lever x Escutcheon x Cylinder – Classroom/Storeroom						\$749.00
627F	Lever x Escutcheon x Cylinder – Nightlatch						
628F	Lever x Escutcheon – Passage and Dummy Free Wheeling						
629F	Lever x Escutcheon – Dummy Rigid						

1. Escutcheon is plated to simulate Stainless Steel.
2. 611 finish is not available on 630, 660 and 670 Series Trims.

NOTE: Cylinder reference indicates function only, all trims are less cylinder.
 See Page 127 for cylinders if required.

When Ordering: Specify design, hand and finish.

**HEAVY-DUTY OFFSET PULL TRIMS
FOR 7100 SERIES RIM, SQUAREBOLT® , SVR, CVR EXITS
(ALL TRIMS PRICED LESS CYLINDER)**

MODEL #	PRODUCT DESCRIPTION	605 626'	606 629'	611 630'	612 693	613E BSP	619 WSP
680F	Offset Pull x Escutcheon (7-1/4") – Dummy	\$747.00					
681F	Offset Pull x Escutcheon x Cyl (7-1/4") – Nightlatch						

**HEAVY-DUTY ELECTRIFIED TRIM
FOR 7100 SERIES RIM, SQUAREBOLT® , SVR EXITS
(ALL TRIMS PRICED LESS CYLINDER)**

MODEL #	PRODUCT DESCRIPTION	605 626'	606 629'	611 630'	612 693	613E BSP	619 WSP
690F	Lever x Escutcheon x Cylinder x Fail Safe AR-AU-CR-JN-MO-PB-PN-VI-HA*	\$1,763.00					
691F	Lever x Escutcheon x Cylinder x Fail Secure AR-AU-CR-JN-MO-PB-PN-VI-HA*						
SM	SPDT Lock and Unlock Monitor Switch	\$455.00					
EX	Trim Gasket for Exterior Applications	\$45.00					

*See the Variations page for HA price add.

WITH REFLECTIONS® LEVER DESIGNS:

MODEL #	PRODUCT DESCRIPTION	605 626'	606 629'	611 630'	612 BSP	613E WSP	619
690F	Lever x Escutcheon x Cylinder x Fail Safe	\$1,763.00					
691F	Lever x Escutcheon x Cylinder x Fail Secure						

1. Escutcheon is plated to simulate Stainless Steel.

NOTE: Cylinder reference indicates function only, all trims are **less cylinder**.
See Page 127 for cylinders if required.

NOTE: Heavy-duty 600F Trim required for 7160 CVR Series escutcheon applications. 540F Rose Trim available.
690F and 691F trims are not for use on the 7160 CVR Device.

When Ordering: Specify design and finish.

7130 SERIES MORTISE EXIT DEVICES

MODEL #	PRODUCT DESCRIPTION	605 606 611 612 613E 619 629 630 693 BSP WSP
MORTISE:		
7130	Panic Rated	\$2,828.00
7130-2	Panic Rated Double Cylinder	\$3,098.00
7130F	Fire Rated	\$3,080.00
7130F-2	Fire Rated Double Cylinder	\$3,350.00

When Ordering: Specify weight, height, hand and finish.

**HEAVY-DUTY ESCUTCHEON TRIMS
FOR 7130 SERIES MORTISE EXIT DEVICES
(ALL TRIMS PRICED LESS CYLINDER)**

MODEL #	PRODUCT DESCRIPTION	605 606 611 ² 612 613E 619 626 ¹ 629 ¹ 630 ¹ 693 BSP WSP						
		620F	Blank Escutcheon – Exit Only-Lever/Knob Prep	\$518.00				
634F	Pull x Escutcheon – Dummy	\$518.00						
656F	Lever x Escutcheon x Cylinder – Nightlatch AR-AU-CR-JN-MO-PB-PN-VI-HA*	\$749.00						
658F	Lever x Escutcheon – Dummy Trim AR-AU-CR-JN-MO-PB-PN-VI-HA*							
661F	Escutcheon x Cylinder – Nightlatch	\$334.00						
662F	Pull x Escutcheon x Cylinder – Nightlatch	\$518.00						
673F	Pull x T.P. x Escutcheon x Cylinder – Classroom/Storeroom x TT	\$653.00						
675F	Pull x T.P. x Escutcheon – Passage x T-Piece							

*See the Variations page for HA price add.

WITH REFLECTIONS® LEVER DESIGNS:

MODEL #	PRODUCT DESCRIPTION	605 606 611 612 613E 619 626 ¹ 629 ¹ 630 ¹ BSP WSP						
		656F	Lever x Escutcheon x Cylinder – Nightlatch	\$749.00				
658F	Lever x Escutcheon – Dummy							

1. Escutcheon is plated to simulate Stainless Steel. See the Variations page for details.
2. 611 finish is not available on 630, 660 and 670 Series Trims.

**HEAVY-DUTY OFFSET PULL TRIM
FOR 7130 SERIES MORTISE EXIT DEVICES
(ALL TRIMS PRICED LESS CYLINDER)**

MODEL #	PRODUCT DESCRIPTION	605 606 611 612 613E 619 626 ¹ 629 ¹ 630 ¹ 693 BSP WSP						
		684F	Offset Pull x Escutcheon x Cylinder (7-1/4") – Nightlatch	\$793.00				

1. Escutcheon is plated to simulate Stainless Steel.

NOTE: Cylinder reference indicates function only, all trims are **less cylinder**.
Cylinder rings/collars not furnished with trim if ordered less cylinder.



See Page 127 for cylinders are required.

When Ordering: Specify design and finish.

7200 SERIES NARROW STILE EXIT DEVICES

MODEL #	PRODUCT DESCRIPTION	605 606 611 612 613E 619 629 630 693 BSP WSP
PANIC EXIT DEVICES:		
7200	Rim Panic Rated	\$2,928.00
7250	SquareBolt® Panic	\$3,016.00
7210	SVR Panic Rated	\$3,531.00
7220	CVR Panic Rated	\$3,619.00

7200M SERIES NARROW DESIGN EXIT DEVICES

MODEL #	PRODUCT DESCRIPTION	605 606 611 612 613E 619 629 630 693 BSP WSP
RIM:		
7200M	Panic Rated	\$2,928.00
7200MF	Fire Rated	\$3,180.00
SQUAREBOLT®:		
7250M	Panic Rated	\$3,016.00
7250MWS	Panic Rated Windstorm Certified  Hurricane	\$3,183.00
7250MF	Fire Rated	\$3,268.00
7250MFWWS	Fire Rated Windstorm Certified  Hurricane	\$3,435.00
SURFACE VERTICAL ROD:		
7210M	Panic Rated	\$3,531.00
7210MF	Fire Rated	\$3,783.00
CONCEALED VERTICAL ROD:		
7220M	Panic Rated	\$3,619.00
7220MF	Fire Rated	\$3,871.00

TRIM FOR 7200 SERIES RIM, SQUAREBOLT®, SVR, CVR EXITS (ALL TRIMS PRICED LESS CYLINDER)

MODEL #	PRODUCT DESCRIPTION	All Finishes
*121NL	Nightlatch Trim	\$85.00

Not recommended for VR exit devices. See page 127 for cylinder options.

When Ordering: Specify width, hand and finish.
Specify height for vertical rods.

**STANDARD DUTY OFFSET PULL TRIMS
FOR 7200 SERIES RIM, SQUAREBOLT®, SVR, CVR EXITS
(ALL TRIMS PRICED LESS CYLINDER)**

MODEL #	PRODUCT DESCRIPTION	605 606 611 612 613E 619 626 629 630 693 BSP WSP
480F	Offset Pull x Escutcheon (7-1/4") – Dummy	\$657.00
481F	Offset Pull x Escutcheon x Cyl (7-1/4") – Nightlatch	
482F	Offset Pull x Escutcheon (9", 15" & 18") – Dummy	
483F	Offset Pull x Esc x Cyl (9", 15" & 18") – Nightlatch	

**NARROW ESCUTCHEON TRIMS
FOR 7200 SERIES RIM, SQUAREBOLT®, SVR, CVR EXITS
(ALL TRIMS PRICED LESS CYLINDER)**

MODEL #	PRODUCT DESCRIPTION	605 606 611 612 613E 619 626 629 630 693 BSP WSP
500F	Blank Escutcheon – Exit Only	\$341.00
501F	Escutcheon x Cylinder – Nightlatch	
503F	Thumbturn x Escutcheon x Cylinder – Classroom/Storeroom x TT	\$669.00
506F	Lever x Escutcheon x Cylinder – Classroom/Storeroom AR-AU-CR-JN-MO-PB-PN-VI-HA*	\$883.00
507F	Thumbturn x Escutcheon – Passage x TT	\$669.00
508F	Lever x Escutcheon – Passage/Dummy AR-AU-CR-JN-MO-PB-PN-VI-HA*	\$883.00
509F	Lever x Escutcheon – Dummy AR-AU-CR-JN-MO-PB-PN-VI-HA*	
512F	Pull x Escutcheon x Cylinder – Nightlatch	\$392.00
513F	Pull x Escutcheon x Thumbturn x Cylinder – Classroom/Storeroom x TT	\$821.00
514F	Pull x Escutcheon – Nightlatch – Dummy Trim	\$392.00
517F	Pull x Escutcheon x Thumbturn – Classroom/Storeroom x TT – Passage	\$821.00
518F	Pull x Escutcheon x Thumbpiece x Cylinder – Classroom/Storeroom x T-Piece	\$774.00
519F	Pull x Escutcheon x Thumbpiece – Passage x T-Piece	

*See the Variations page for HA price add.

WITH REFLECTIONS® LEVER DESIGNS:

MODEL #	PRODUCT DESCRIPTION	605 606 611 612 613E 619 626 629' 630'
506F	Lever x Escutcheon x Cylinder – Classroom/Storeroom	\$883.00
508F	Lever x Escutcheon – Passage/Dummy	
509F	Lever x Escutcheon – Dummy	

NOTE: Cylinder reference indicates function only, all trims are **less cylinder**.
Cylinder rings/collars not furnished with trims ordered less cylinders.
See Page 127 for cylinders if required.

When Ordering: Specify design and finish.

7000 SERIES ELECTRIFIED EXIT DEVICES

ELECTRIFIED OPTIONS CHART:

MODEL #	EXIT DEVICE DESCRIPTION	A	B	D	G	O	MELR	S	SAFE	SECURE
7100(F)	Rim Exit Device (Wide)	x	x	x	x	x	x	x		
7110(F)	Surface Vertical Rod (Wide)	x	x	x	x	x	x	x		
7120(F)	Concealed Vertical Rod (Wide)	x	x	x	x	x	x	x		
7130(F)	Mortise Exit Device (Wide)	x	x	x	x	x	x	x	x	x
7150(F)	Rim SquareBolt® Device (Wide)	x	x	x	x	x	x	x		
7150(F)WS	Rim SquareBolt® Windstorm (Wide)	x	x				x	x		
7160(F90)	Concealed Vertical Rod (Wide)	x	x	x	x	x	x	x		
7170(F90)	Surface Vertical Rod (Wide)	x	x	x	x	x	x	x		
7170(F90)WS	Surface Vertical Rod Windstorm (Wide)	x	x				x	x		
7200(M)(F)	Rim Exit Device (Narrow)	x	x	x	x		x	x		
7210(M)(F)	Surface Vertical Rod (Narrow)	x	x	x	x		x	x		
7220(M)(F)	Concealed Vertical Rod (Narrow)	x	x	x	x		x	x		
7250(M)(F)	Rim SquareBolt® Device (Narrow)	x	x	x	x		x	x		

ELECTRIFIED OPTIONS:

OPTION	DESCRIPTION	LIST PRICE ADD
A	Alarm Kit (less cylinder)	\$1,137.00
B	Touchbar Monitoring or Signaling REX	\$358.00
D	Delayed Egress	\$2,534.00
G	Electric Dogging	\$732.00
O	Trim Monitoring or Signaling	\$358.00
MELR	Motor Latch Retraction	\$1,296.00
S	Latchbolt Status Monitoring or Signaling	\$381.00
SAFE	Mortise Device Lock with Outside Trim Control (Fail Unlock) – Lever Trims Only	\$1,167.00
SECURE	Mortise Device Lock with Outside Trim Control (Fail Lock) – Lever Trims Only	

NOTE: Latchbolt status monitor required for 7110, 7170 and 7210 series surface vertical rod exit devices with alarms.
Example: 7110AS x Door Width x Door Height x RHR x 630

MELR KITS:

MODEL #	PRODUCT DESCRIPTION	LIST PRICE
RMELR-36	Motor Latch Retraction Kit for the 7100-36 Exits	\$1,296.00
RMELR-36-0	Motor Latch Retraction Kit for the 7100-36 Exits w/the O Electrified Option	\$1,654.00
RMELR-36-WS	Motor Latch Retraction Kit for the 7100-36 Exits w/the WS Option	\$1,463.00
RMELR-36-0-WS	Motor Latch Retraction Kit for the 7100-36 Exits w/the WS Option and the O Electrified Option	\$1,821.00
RMELR-38	Motor Latch Retraction Kit for the 7200-36 Exits	\$1,296.00
RMELR-38-0	Motor Latch Retraction Kit for the 7200-36 Exits w/the O Electrified Option	\$1,654.00
RMELR-48	Motor Latch Retraction Kit for the 7100-48 Exits	\$1,296.00
RMELR-48-0	Motor Latch Retraction Kit for the 7100-48 Exits w/the O Electrified Option	\$1,654.00
RMELR-48-WS	Motor Latch Retraction Kit for the 7100-48 Exits w/the WS Option	\$1,463.00
RMELR-48-0-WS	Motor Latch Retraction Kit for the 7100-48 Exits w/the WS Option and the O Electrified Option	\$1,821.00

ACCESSORIES:

MODEL #	PRODUCT DESCRIPTION	LIST PRICE
60-7700-0159	Motor Control & Housing Assy	\$463.00
60-7700-0359	Harness Assy	\$34.00

ALARM KITS:

MODEL #	PRODUCT DESCRIPTION	LIST PRICE
7116-36	Alarm Kit (Less cylinder)	\$1,137.00
7116-48	Alarm Kit (Less cylinder)	
7216-36	Alarm Kit (Less cylinder)	

NOTE: The 7116 alarm kit cannot be retrofitted in the field to the 7110(F), 7170(F), 7210 or 7210M(F) surface vertical rod exit devices. This option is available as a factory order only.

When Ordering: Specify design and finish.

7000 SERIES DELAYED EGRESS EXIT DEVICES

SUFFIX	PRODUCT DESCRIPTION	LIST PRICE OPTION ADDS
NFPA 30	30-Second Delay Board "NFPA"	N/C
BOCA 15	15-Second Delay Board "BOCA"	
BOCA 30	30-Second Delay Board "BOCA"	
OPTIONS AVAILABLE WITH RIM, SQUAREBOLT® EXITS:		
D	Delayed Exit Only or with Outside Trim Entry	\$2,534.00
D x S	Delayed Exit Only or Outside Trim Entry with Bolt Monitor	\$2,915.00
D x O	Delayed Exit with Outside Trim Entry with DPS by Others	\$2,892.00
D x O x S	Delayed Exit with Outside Trim Entry with Bolt Monitor and DPS by Others	\$3,273.00
OPTIONS AVAILABLE WITH CONCEALED VERTICAL ROD EXITS:		
D	Delayed Exit Only or Outside Trim Entry	\$2,534.00
D x S	Delayed Exit Only or Outside Trim Entry with Vertical Rod Monitor	\$2,915.00
D x O	Delayed Exit with Outside Trim Entry with DPS by others	\$2,892.00
D x O x S	Delayed Exit with Outside Trim Entry with Vertical Rod Monitor and DPS by others	\$3,273.00
OPTIONS AVAILABLE WITH MORTISE EXITS:		
D	Delayed Exit Only or Outside Trim Entry	\$2,534.00
D x O	Delayed Exit with Outside Trim Entry with DPS by others	\$2,892.00
D x SAFE	Delayed Exit with Electric Trim Control Fail Safe	\$3,701.00
D x SECURE	Delayed Exit with Electric Trim Control Fail Secure	

NOTES: Suffix options required to product model number.
See page 208 for power supplies and electrified accessories.

When Ordering: Specify finish.
Specify cylinder ring/collar size where required.

MODEL #	PRODUCT DESCRIPTION	*ALL FINISHES
RIM CYLINDERS FOR 480F, 500F, 510F, 620F, 630F, 680F, 690F SERIES AND 121NL NIGHTLATCH TRIM:		
1109	Standard Cylinder 6-Pin	\$108.00
1109	Standard Cylinder 7-Pin	\$110.00
1709	CMK Cylinder 6-Pin	\$124.00
1709	CMK Cylinder 7-Pin	\$126.00
1193	Large Format Interchangeable Core Cylinder 6-Pin	\$194.00
1193	Large Format Interchangeable Core Cylinder 7-Pin	\$196.00
5109	Security Cylinder 6-Pin	\$425.00
5109	Security Cylinder 7-Pin	\$429.00
U5109	High Security Cylinder 6-Pin	\$569.00
U5109	High Security Cylinder 7-Pin	\$573.00
5193	Security Large Format Interchangeable Core Cylinder 6-Pin	\$526.00
5193	Security Large Format Interchangeable Core Cylinder 7-Pin	\$530.00
K300	ACCENTRA KeyMark® Cylinder 6- or 7-Pin	\$136.00
K840	ACCENTRA KeyMark Large Format Interchangeable Core Cylinder 6-Pin or 7-Pin	\$234.00
K640	ACCENTRA KeyMark Small Format Interchangeable Core Cylinder 6- or 7-Pin	\$228.00
A640	Best® Keyway Small Format Interchangeable Core Cylinder 6- or 7-Pin	\$184.00
2109	Schlage® "C" Keyway Cylinder 6-Pin - 0-bitted or Keyed Random	\$108.00
MORTISE CYLINDERS FOR 650F, 660F, 670F, 680F SERIES TRIM & CYLINDER DOGGING:		
2153	Standard Cylinder 6-Pin	\$108.00
2153	Standard Cylinder 7-Pin	\$110.00
2196	Large Format Interchangeable Core Cylinder 6-Pin	\$194.00
2197	Large Format Interchangeable Core Cylinder 7-Pin	\$196.00
5153	Security Cylinder 6-Pin	\$425.00
5153	Security Cylinder 7-Pin	\$429.00
U5153	High Security Cylinder 6-Pin	\$569.00
U5153	High Security Cylinder 7-Pin	\$573.00
5196	Security Large Format Interchangeable Core Cylinder 6-Pin	\$526.00
5197	Security Large Format Interchangeable Core Cylinder 7-Pin	\$530.00
K100	ACCENTRA KeyMark® Cylinder 6- or 7-Pin	\$126.00
K820	ACCENTRA KeyMark Large Format Interchangeable Core Cylinder 6-Pin or 7-Pin	\$234.00
K620	ACCENTRA KeyMark Small Format Interchangeable Core Cylinder 6-Pin or 7-Pin	\$228.00
A620	Best® Keyway Small Format Interchangeable Core Cylinder 6- or 7-Pin	\$184.00

NOTE: Cylinder rings/collars furnished at no charge when ordered with cylinder.
Specify ring/collar size when ordering.

*Rim cylinders not available in 629 or 630 finishes.

When Ordering: Specify finish.
Specify cylinder ring/collar size where required.

CYLINDERS

MODEL #	PRODUCT DESCRIPTION	ADD TO TRIM	ORDERED SEPARATELY
COMPONENT CYLINDERS FOR 540F SERIES TRIM:			
1802	Standard Cylinder 6-Pin	STD	\$94.00
1802A	Standard Cylinder 7-Pin	\$2.00	\$96.00
5802	Security Cylinder 6-Pin	\$279.00	\$373.00
5802A	Security Cylinder 7-Pin	\$283.00	\$377.00
1210	Large Format Interchangeable Core Only 6-Pin	\$86.00	\$86.00
1220	Large Format Interchangeable Core Only 7-Pin	\$88.00	\$88.00
5210	Security Large Format Interchangeable Core Only 6-Pin	\$343.00	\$343.00
5220	Security Large Format Interchangeable Core Only 7-Pin	\$347.00	\$347.00
K402	ACCENTRA KeyMark® Cylinder	\$24.00	\$118.00
K800	ACCENTRA KeyMark® Large Format Interchangeable Core Only 6-or 7-Pin	\$126.00	\$126.00
K600	ACCENTRA KeyMark® Small Format Interchangeable Core Only 6-or 7-Pin	\$120.00	\$120.00
A600	Best® Keyway Small Format Interchangeable Core Only 6-or 7-Pin	\$76.00	\$76.00
2802	Schlage® "C" Keyway Cylinder 6-Pin - 0-bitted or Keyed Random	\$0.00	\$94.00
3804	Other Manuf. Keyway Cylinder 6-Pin - Keyed Random, Specify Keyway	\$24.00	\$118.00

ACCENTRA KeyMark® and Security products are priced separately. The cylinders are not discounted the same as the trim.

MISCELLANEOUS

MODEL #	PRODUCT DESCRIPTION	LIST PRICE
LONG SPINDLE KIT:		
81-9500-1665-000	2" – 2-1/2" door thickness for 620F and 630F series trim	\$57.00
81-9500-1635-000	2-1/2" – 3-1/2" door thickness for 620F and 630F series trim	\$119.00
81-9500-1636-000	3-1/2" – 4-1/2" door thickness for 620F and 630F series trim	

When Ordering: Specify finish.
Specify cylinder ring/collar size where required.

MISCELLANEOUS

MODEL #	PRODUCT DESCRIPTION	ALL FINISHES
CYLINDER DOGGING KIT:		
715-48	Cylinder Dogging Kit (less cylinder)	\$255.00

MODEL #	PRODUCT DESCRIPTION	605 606 611 612 613E 619 629 630 693 BSP WSP
DUMMY PUSH BAR:		
720 DB	Dummy Push Bar	\$1,012.00

MODEL #	PRODUCT DESCRIPTION	ORDERED W/ DEVICE ADD	ORDERED SEPARATELY
TOUCH PAD COVERS: (INDICATE LENGTH, 36" OR 48")			
730 BN	Black Nylon Finish	\$108.00	\$209.00
730 SS	Stainless Steel	N/C	\$186.00
730 (FIN)	Specify Finish	N/C	\$212.00
730 LUM	Lumi-Lite® Photoluminescence Powder Coat (Indicate "LUM" option with device)	\$627.00	\$771.00



MODEL #	PRODUCT DESCRIPTION	ORDERED W/ DEVICE ADD	ORDERED SEPARATELY
STRIKES (BLACK):			
702	Floor Strike (optional)	N/C	\$53.00
712	Strike for Overlapping Astragal (optional for 7130)	N/C	
718	Open Back Strike (optional)	\$181.00	\$234.00
726	Strike and Angle Bracket	N/C	\$103.00
757F	Rim Strike 7100(F), 7200M(F)	N/C	\$97.00
757FWS	Rim Strike for Windstorm Devices 7150(F)WS, 7250M(F)WS 	N/C	\$137.00
759	Rim Strike, 7200	N/C	\$71.00
761	Top Strike Recessed 7160(F)	N/C	\$103.00
790	Floor Strike	N/C	\$53.00
791	Top Strike	N/C	\$103.00
793	Rim Strike (optional)	N/C	\$85.00
794	Bottom Flush Strike (optional)	N/C	\$53.00
797	Top Strike Bracket (SVR optional)	N/C	\$7.00
798	Mortise Strike	N/C	\$53.00
202	Strike Box (not finished, optional)	\$2.00	\$2.00

When Ordering: Specify finish.

MODEL #	PRODUCT DESCRIPTION	ALL FINISHES
END CAP KITS AND MISC:		
ECK1	Flush End Cap Kit (81-9500-0620-FIN) No charge when ordered with device.	\$121.00
ECK7	Standard End Cap Kit No charge when ordered with device.	\$108.00
60-7000-0815	Schlage® cam and housing assembly	\$32.00
1145VD	Tailpiece for 1109 cylinders to operate Von Duprin® (No charge when ordered with cylinder)	\$6.40

MODEL #	PRODUCT DESCRIPTION	ALL FINISHES
MORTISE LOCKS (LOCK BODY ONLY):		
35LF	Mortise Lock Storeroom - Lever Trim (60-7030-0391 x Hand)	\$902.00
35KF	Mortise Lock Storeroom - Knob Trim (60-7030-0387 x Hand)	
35TF	Mortise Lock Storeroom - Thumbpiece Trim	
38LF	Mortise Lock Classroom - Lever Trim (60-7030-0393 x Hand)	
38KF	Mortise Lock Classroom - Knob Trim (60-7030-0389 x Hand)	
38TF	Mortise Lock Classroom - Thumbpiece Trim 60-07030-0385 x Hand)	









PRODUCT #	PRODUCT DESCRIPTION	ALL FINISHES
EXTENSIONS FOR 7000 SERIES VERTICAL RODS:		
7010-2	2" Extension	\$110.00
7010-6	6" Extension	\$126.00
7010-12	12" Extension	\$141.00
7010-24	24" Extension	\$167.00
DOGGING KEY: (size 5/16" - no finish)		\$2.00
DRILL JIG: (throw away - no finish)		

PRODUCT #	PRODUCT DESCRIPTION	BLACK
SHIM KITS TO CLEAR GLASS MOLDING:		
723	7100 Series Rim, Mortise & CVR	\$158.00
723NS	7200 Series Rim & CVR	
724	7110, 7170 Series SVR	\$216.00
724NS	7210 Series SVR	
723WS	7150(F)WS Windstorm  Hurricane	\$235.00
723NSWS	7250M(F)WS Windstorm  Hurricane	
724WS	7170(F)WS Windstorm  Hurricane	
ANTI-PRY:		
725	7100 Rim and 7150 SquareBolt® Anti-pry Bracket	\$81.00

PART #	PRODUCT DESCRIPTION	LIST PRICE
60-7000-9100-999	Plastic Installation Template used for installation of all 7100 and 7200 Devices	\$5.10

When Ordering: Specify finish where required.

REMOVABLE MULLIONS

MODEL #	PRODUCT DESCRIPTION	600	628 695
REMOVABLE MULLIONS:			
M200	Steel Mullion - Panic Rated x 7'2"	\$956.00	-
M200F	Steel Mullion - 3 Hour Fire Rated x 7'2"	\$1,329.00	
M200F	Steel Mullion - 3 Hour Fire Rated x 10'	\$1,352.00	
M200FWS	Steel Mullion - 3 Hour Fire Rated, Windstorm Certified x 7'2"*  	\$1,825.00	
M200FWS	Steel Mullion - 3 Hour Fire Rated, Windstorm Certified x 8'*  	\$1,852.00	
M200SM	Split Mullion - Steel Panic Rated x 8'	\$1,155.00	
M300	Aluminum Mullion - Specify 8' or 10' (For 9' specify 10' and cut in field)	-	\$1,591.00
KEYED REMOVABLE MULLIONS:			
KRM200	Steel Mullion - Panic Rated x 7'2"	\$1,589.00	-
KRM200F	Steel Mullion - 1-1/2 Hour Fire Rated x 7'2"	\$1,919.00	
KRM200F	Steel Mullion - 1-1/2 Hour Fire Rated x 10'	\$1,944.00	
KRM200FWS	Steel Mullion - 3 Hour Fire Rated, Windstorm Certified x 7'2"  	\$2,382.00	
KRM200FWS	Steel Mullion - 3 Hour Fire Rated, Windstorm Certified x 8'  	\$2,403.00	
KRM200SM	Split Mullion - Steel Panic Rated x 8'	\$1,791.00	

*For use with UL Listed door assemblies that comply to FEMA 361 and ICC 500.

NOTES:

Mullion Cylinder Kit not included with KRM Mullions. Must order separately.

Mullions longer than 8' must be ordered as fire rated option x 10' length. Fire rating is valid only up to 96".

MODEL	PRODUCT DESCRIPTION	LIST PRICE
MULLION CYLINDER KITS		
AMCK1	KRM200 - Steel Mullion - Panic Rated x 7'2"	\$108.00
	KRM200F - Steel Mullion - 1-1/2 Hour Fire Rated x 7'2" or 10'	
	KRM200SM - Split Mullion - Steel Panic Rated x 8'	
AMCK2	KRM200FWS - Steel Mullion - 3 Hour Fire Rated, Windstorm Certified x 7'2" or 8'	

*Specify Finish and Cylinder Key Code when ordering

Ex: AMCK1 x FINISH x CYLINDER CODE (i.e. AMCK1 x 630 x CT6)

MODEL	PRODUCT DESCRIPTION	CYLINDER LENGTH	COLLAR SIZE		ALL FINISHES
			STD. MULLION / WS MULLION		
MORTISE CYLINDERS FOR KRM SERIES: (CYLINDERS ARE NOT INCLUDED WITH MULLIONS, MUST BE ORDERED SEPARATELY)					
2153	Standard Cylinder 6-Pin	1-1/8"	1765.312	1765.156	\$108.00
2153	Standard Cylinder 7-Pin	1-1/4"	1765.500	1765.250	\$110.00
2196	Large Format Interchangeable Core Cylinder 6-Pin	1-1/2"	1765.750	1765.500	\$194.00
2197	Large Format Interchangeable Core Cylinder 7-Pin	1-11/16"	1765.844	1765.719	\$196.00
5153	Security Cylinder 6-Pin	1-1/8"	1765.312	1765.156	\$425.00
5153	Security Cylinder 7-Pin	1-1/4"	1765.500	1765.250	\$429.00
5196	Security Large Format Interchangeable Core Cylinder 6-Pin	1-1/2"	1765.750	1765.500	\$526.00
5197	Security Large Format Interchangeable Core Cylinder 7-Pin	1-11/16"	1765.844	1765.719	\$530.00
K100	ACCENTRA KeyMark® Cylinder 6- or 7-Pin	1-1/8"	1765.312	1765.156	\$126.00
K100	ACCENTRA KeyMark® Cylinder 6- or 7-Pin	1-1/4"	1765.500	1765.250	
K100	ACCENTRA KeyMark® Cylinder 6- or 7-Pin	1-1/2"	1765.750	1765.500	
K820	ACCENTRA KeyMark® Large Format Interchangeable Core Cylinder 6-Pin	1-1/2"	1765.750	1765.500	\$234.00
K820	ACCENTRA KeyMark® Large Format Interchangeable Core Cylinder 7-Pin	1-11/16"	1765.844	1765.719	
K620	ACCENTRA KeyMark® Small Format Interchangeable Core Cylinder 6-Pin	1-1/4"	1765.500	1765.250	\$228.00
K620	ACCENTRA KeyMark® Small Format Interchangeable Core Cylinder 6- or 7-Pin	1-3-8"	1765.563	1765.500	
A620	Best® Keyway Small Format Interchangeable Core Cylinder 6-Pin	1-1/4"	1765.500	1765.250	\$184.00
A620	Best® Keyway Small Format Interchangeable Core Cylinder 6- or 7-Pin	1-3-8"	1765.563	1765.500	
2553*	Schlage® "C" Keyway Cylinder 6-Pin - 0-bitted or Keyed Random	1-1/8"	1765.312	1765.156	\$108.00

NOTE: Cylinder collars are furnished at no charge when ordered with cylinder. Specify collar size when ordering.

*2553 only available in 606, 612, 613 and 626 finishes.

MODEL/PART #	PRODUCT DESCRIPTION	LIST PRICE
M102S	Mullion Stabilizer Kit (for M300)	\$127.00
M203	Door Frame Spacer Block	\$71.00
M204	Door Frame Angle Bracket	
60-7000-0750	Locking Mechanism for KRM200(F)	\$685.00
60-7000-0752	Locking Mechanism for KRM200FWS	\$715.00
60-7000-0755	Top Retainer Pack for KRM200(F) and KRM200SM x 8'	\$298.00
60-7000-0757	Top Retainer Pack for KRM200FWS	\$318.00
60-7000-0758	Top Retainer Pack for M200FWS x 7' or 8'	
60-7000-0759	Top Retainer Pack for M200(F) x 7' or 8' and M200SM x 8'	\$298.00
60-7000-0760	Bottom Retainer Pack for KRM200(F) and KRM200SM x 8'	\$198.00
60-7000-0761	Bottom Retainer Pack for KRM200FWS	\$318.00
60-7000-0762	Bottom Retainer Pack for M200FWS x 7' or 8'	
60-7000-0763	Bottom Retainer Pack for M200(F) x 7' or 8' and M200SM x 8'	\$198.00
60-7000-0051	Split Mullion Socket Flat Head Screws for M200SM x 8' and KRM200SM x 8'	\$8.00
81-6419-2412-058	#8-32 X 1/2 Mullion Cyl. Set Screw	\$4.00

6000 SERIES EXIT DEVICES

VARIATIONS: Exit Devices and Trims are priced separately. In order to determine the full list price of a 6000 Series Exit Device with trim, it is necessary to add the list price of the device model number and the list price of the trim model number.

STANDARD FINISHES: Exit devices will have an anodized aluminum rail assembly in a complimentary finish. Touchpad scalp and exit device head cover are available in the following finishes.

ANSI/BHMA CODE	FINISH DESCRIPTION
BRASS:	
605	Bright Brass, Clear Coated (Trim Only)
606	Satin Brass, Clear Coated (Trim Only)
BRONZE:	
613E	Dark Oxidized Satin Bronze - equivalent

ANSI/BHMA CODE	FINISH DESCRIPTION
STAINLESS STEEL:	
629	Bright Stainless Steel
630	Satin Stainless Steel
PAINTED:	
BSP	Black Suede Powder Coat
WSP	White Suede Powder Coat

CYLINDERS: Standard 6-Pin cylinders included with 540F Series Rose Trim only. All other keyed trim priced less cylinder, the list price of the cylinder must be added if cylinders are required. Specify cylinder and cylinder collar with collar size.

PRODUCT OPTIONS	ADD
DESIGNER LEVER: (HA)	\$360.00
DUST GUARD: Prefix "D" to model number (refer to Cylinders/Keys catalog for available cylinders)	\$72.00
DOOR WIDTH:	
24" Door Width (Suffix -24) See note 6 page 134.	\$0.00
30"-36" Door Width (Suffix -36)	STD
36"-48" Door Width (Suffix -48)	\$74.00
Door thickness: Doors over 2-1/4"	\$64.00
SLEEVE NUTS: Factory orders only for exact quantity	
SN-104 (For interlock bracket on fire-rated mullions)	\$4.00
SN-134 (4 Pack)	\$9.70
TORX® SECURITY HEAD SCREWS: Standard size only	
Rim Exit Device	\$57.00
UL Rim Exit Device	
Surface Vertical Rod Exit Device (SVR)	\$149.00
Concealed Vertical Rod Exit Device (CVR)	\$57.00
Mortise Exit Device	\$103.00
630F, 660F, 670F Series Trim	\$7.00
121NL, 350F, 540F, 620F, 650F, 680F, 690F Series Trim	N/A
ABRASIVE COATING: On Touchbar Pad (ABCI)	\$114.00
KNURLING: .	
On Touch Pad, available in all finishes (KNI)	\$219.00
For outside trim (KNO)	\$116.00
MICROSHIELD®: Antimicrobial coating. Suffix YMS to model number for each exit device or trim that the coating will be applied. Coating applied to exit device touchpad & cover only.	\$119.00
REFLECTION LEVERS: The following levers are no longer available in 629 and 630 finishes, TT, TU, TW, TX, TY, UX, TG, TJ, TK, TE, TI and TD.	—

When Ordering: Specify design, hand and finish.

6	X	X	XED	Suffix	Size	Design	Trim	Finish	Other Info.
	Second Digit: "1" Standard device, 4-1/2" (114mm) or wider door stile. "2" Narrow stile door or narrow escutcheon trim (500F, 510F Series)	Third Digit: "0" Rim Device, Pullman Latch "1" SVR Device up to 8' (Narrow Stile Only) "2" CVR Device, Metal Doors up to 8' "3" Mortise Device "5" SquareBolt®, Rim Security "6" CVR Device over 8', wood door or LBR "7" SVR Device over 8' or LBR (Wide Stile Only)	Fourth Digit: "0" Standard "5" Cylinder Dogging (Not with suffix "F")	Mechanical Feature "F" - Fire Exit Device "LBR" - Less Bottom Rod (Note 2) "K5" - Mortise Device, E0 or Entry by Key with/ without Rigid Knob. "K8" - Mortise Device, Entry by Knob "L5" - Mortise Device, Entry by Key with/ without Rigid Lever. (Note 1) "L8" - Mortise Device, Entry by Lever "T5" - Mortise Device with Thumbpiece Trim "T8" - Mortise Device, Active Thumbpiece Trim "2" - Double Cylinder Device (Note 3) ELECTRICAL FEATURE "-A" - Alarm Kit "A-ALR" - Alarm Kit (less cylinder) with red screen printed touchpad "-B" - Bar Monitor or Signaling "MELR" - Motor Latch Retraction "-O" - Outside Trim Monitor or Signaling "-S" - Bolt Status Monitor or Signaling "-Safe" - Mortise Device Trim Control (Lever Only) "-Secure" - Mortise Device Trim Control (Lever Only) "-P" - Electric Latch Retraction	Size: DOW = Door Opening Width) "24" - 24" DOW "36" - 30" to 36" DOW "42" - 36"-42" DOW "48" - 42" to 48" DOW Door Height: -7 = 7' standard -8 = 8' (2.44m) -9 = 9' (2.74m) -10 = 10' (3.05m)	Trim Design (Lever or knob only)	Trim Model Number	See Page 133	Other Information: Door Hand RHR or LHR Door Thickness Over 1-3/4" (45mm) Fastener Options TORX® Security Screws SNB (wood, composite, or unreinforced metal doors) Specialty Cylinders & components

NOTES:

1. Required for electrical feature, Suffix "-SAFE" or "-SECURE".
2. LBR available on 6160ED(F90) and 6170ED(F90) devices only.
3. For double cylinder devices, suffix "-2" after fourth digit.
4. Maximum opening size 8'0" x 8'0".
5. Contact Ceco, Curries® or Fleming for detailed frame/door requirements and limitations.
6. If "-24" device is to be used with a DOW greater than 24", the device will ship without UL label. The 12" touchpad will not cover 50% of the device touchbar length.

MAX. OPENING	DOOR TYPE	FIRE RATING	MODEL NO.	STYLE	STRIKE
SURFACE VERTICAL ROD (2 point latch):					
4' x 10'	Alum/Metal	None	6210	Narrow	Surface
4' x 10'	Metal or Wood	None	6170	Wide	Surface
8' x 10'	Metal or Wood	1-1/2 Hour "B"	6170F	Wide	Surface
CONCEALED VERTICAL ROD (2 point latch):					
4' x 10'	Metal or Wood	None	6160	Wide	Mortise
8' x 10'	Metal or Wood	1-1/2 Hour "B"	6160F	Wide	Mortise
4' x 10'	Alum/Metal	None	6220	Narrow	Surface

- NOTE:** Height must be specified when ordering Vertical Rod Exit Devices.
- "-7" Openings up to 7' - Standard on 6170ED(F), 6210, 6170ED SVR.
 - "-8" Openings 7' to 8' - Optional on SVR. Std on 6160(F)ED, 6220, 6160ED.
 - "-9" Openings 8' to 9' - Optional on 6170ED (F90), 6160ED (F90) CVR only.
 - "-10" Openings 9' to 10' - Optional on 6170ED (F90), 6160ED (F90) CVR only.

MECHANICAL OPTIONS

OPTION	DESCRIPTION	LIST PRICE ADD
BPL	Bottom Pullman Latch. Suffix BPL to 6210 & 6220 Panic Rated surface vertical rod exits.	\$47.00
LBR	Less Bottom Rod. Suffix LBR to 6160 & 6170 series only.	\$0.00
YMS	MicroShield® antimicrobial coating. Suffix YMS to model number for each exit device or trim that the coating will be applied.	\$119.00
Cylinder Dogging	Inside cylinder dogging for Panic Rated Exits only. Change fourth digit of model number from "0" to "5" . (Less cylinder)	\$138.00
Door Height over 8' to 10'	See catalog	\$156.00

6100ED SERIES EXIT DEVICES

MODEL #	PRODUCT DESCRIPTION	613E 629 630 BSP WSP
RIM:		
6100ED	Panic Rated	\$1,310.00
6100-2ED^	Panic Rated Double Cylinder	\$1,524.00
6100FED	Fire Rated	\$1,562.00
6100F-2ED^	Fire Rated Double Cylinder	\$1,776.00
SQUAREBOLT®:		
6150ED	Panic Rated	\$1,398.00
6150-2ED^	Panic Rated Double Cylinder	\$1,612.00
6150FED	Fire Rated	\$1,650.00
6150F-2ED^	Fire Rated Double Cylinder	\$1,864.00
SURFACE VERTICAL ROD:		
6170ED	Panic Rated	\$1,703.00
6170FED	Fire Rated	\$1,955.00
CONCEALED VERTICAL ROD:		
6160ED	Panic Rated	\$1,798.00
6160FED	Fire Rated	\$2,050.00

*Not approved for LBR

^Handed unit, handing must be specified

When Ordering: Specify width, hand and finish.
Specify height for vertical rods.

TRIM
FOR 6100ED SERIES RIM, SQUAREBOLT® , SVR, CVR EXITS
(ALL TRIMS PRICED LESS CYLINDER)

MODEL #	PRODUCT DESCRIPTION	All Finishes
*121NL	Nightlatch Trim	\$85.00

Not recommended for VR exit devices. See page 145 for cylinder options.

ROSE TRIMS
FOR 6100ED SERIES RIM, SQUAREBOLT® , SVR, CVR EXITS
(STANDARD CYLINDERS INCLUDED)

MODEL #	PRODUCT DESCRIPTION	605 606 613E 626 BSP WSP
541F	AU-MO-PB Key-In-Lever – Nightlatch	\$684.00
546F	AU-MO-PB Key-In-Lever – Classroom	
548F	AU-MO-PB Active Lever – Dummy Free Wheeling	\$590.00
549F	AU-MO-PB Rigid Lever – Dummy Rigid	

Heavy-duty 600F Trim required for 6160 CVR Series escutcheon applications. 540F Rose Trim available.

TRIM OPTION PREFIXES			
B-	Prefix for SFIC core prep Key-In-Lever Trim Available with AU, MO, and PB levers.	ADD	\$0.00
M-	Prefix for Medeco®/ASSA® IC Core Prep Key-In-Lever Trim Available with AU levers.		\$0.00
S-	Prefix for Schlage® cylinder prep Key-In-Lever Trim Available with AU, MO, and PB levers.		\$0.00
SI-	Prefix for Schlage® IC Core Prep Key-In-Lever Trim. Available with AU, MO, and PB levers.		

NOTE: See Page 145 for other cylinder options.

When Ordering: Specify design and finish.

**HEAVY-DUTY ESCUTCHEON TRIMS
FOR 6100ED SERIES RIM, SQUAREBOLT® , SVR, CVR EXITS
(ALL TRIMS PRICED LESS CYLINDER)**

MODEL #	PRODUCT DESCRIPTION	630
420F	Blank Escutcheon Plate	\$307.00
421F	Escutcheon x Cylinder	
426F	Lever x Escutcheon x Cylinder AU-MO-PB	\$417.00
427F	Lever x Escutcheon x Cylinder AU-MO-PB	
428F	Lever x Escutcheon AU-MO-PB	
429F	Lever x Escutcheon AU-MO-PB	

NOTE: Cylinder reference indicates function only, all trims are **less cylinder**.
Cylinder rings/collars not furnished with trims ordered less cylinders.
All 420F series and 440F series trims are discounted the same as the 2100 exit.

MODEL #	PRODUCT DESCRIPTION	605 606 613E 629' 630' BSP WSP
626F	Lever x Escutcheon x Cylinder AR-AU-CR-JN-MO-PB-PN-VI-HA*	\$749.00
627F	Lever x Escutcheon x Cylinder AR-AU-CR-JN-MO-PB-PN-VI-HA*	
628F	Lever x Escutcheon AR-AU-CR-JN-MO-PB-PN-VI-HA*	
629F	Lever x Escutcheon AR-AU-CR-JN-MO-PB-PN-VI-HA*	
632F	Pull x Escutcheon x Cylinder	\$518.00
633F	Pull x T.P. x Escutcheon x Cylinder	\$653.00
634F	Pull x Escutcheon	\$518.00
635F	Pull x T.P. x Escutcheon	\$653.00

*See the Variations page for HA price add.

MODEL #	PRODUCT DESCRIPTION	626
ROSE TRIMS: (Standard Cylinders Included)		
441F	AU-MO-PB Key-In-Lever	\$252.00
446F	AU-MO-PB Key-In-Lever	
448F	AU-MO-PB Active Lever	\$208.00
449F	AU-MO-PB Rigid Lever	

NOTE: All 420F series and 440F series trims are discounted the same as the 2100 exit.

WITH REFLECTIONS® LEVER DESIGNS:

MODEL #	PRODUCT DESCRIPTION	605 606 613E 629' 630' BSP WSP
626F	Lever x Escutcheon x Cylinder	\$749.00
627F	Lever x Escutcheon x Cylinder	
628F	Lever x Escutcheon	
629F	Lever x Escutcheon	

1. Escutcheon is plated to simulate Stainless Steel.

NOTE: Cylinder reference indicates function only, all trims are less cylinder. See Page 145 for cylinders if required.
See page 161 for 420F and 440F trim pricing.

When Ordering: Specify design, hand and finish.

**HEAVY-DUTY ELECTRIFIED TRIM
FOR 6100ED SERIES RIM, SQUAREBOLT®, SVR EXITS
(ALL TRIMS PRICED LESS CYLINDER)**

MODEL #	PRODUCT DESCRIPTION	605 606 613E 629' 630' BSP WSP
690F	Lever x Escutcheon x Cylinder x Fail Safe AR-AU-CR-JN-MO-PB-PN-VI-HA*	\$1,763.00
691F	Lever x Escutcheon x Cylinder x Fail Secure AR-AU-CR-JN-MO-PB-PN-VI-HA*	
SM	SPDT Lock and Unlock Monitor Switch	\$455.00
EX	Trim Gasket for Exterior Applications	\$45.00

*See the Variations page for HA price add.

WITH REFLECTIONS® LEVER DESIGNS:

MODEL #	PRODUCT DESCRIPTION	605 606 613E 629' 630' BSP WSP
690F	Lever x Escutcheon x Cylinder x Fail Safe	\$1,763.00
691F	Lever x Escutcheon x Cylinder x Fail Secure	

1. Escutcheon is plated to simulate Stainless Steel. See the Variations page for details.

NOTE: Cylinder reference indicates function only, all trims are **less cylinder**.
See Page 145 for cylinders if required.

NOTE: Heavy-duty 600F Trim required for 6160ED CVR Series escutcheon applications. 540F Rose Trim available.
690F and 691F trims are not for use on the 7160 CVR Device.

When Ordering: Specify design and finish.

6130ED SERIES MORTISE EXIT DEVICES

MODEL #	PRODUCT DESCRIPTION	613E 629 630 BSP WSP
MORTISE:		
6130ED	Panic Rated	\$1,698.00
6130-2ED	Panic Rated Double Cylinder	\$1,912.00
6130FED	Fire Rated	\$1,950.00
6130F-2ED	Fire Rated Double Cylinder	\$2,164.00

When Ordering: Specify weight, height, hand and finish.

**HEAVY-DUTY ESCUTCHEON TRIMS
FOR 6130ED SERIES MORTISE EXIT DEVICES
(ALL TRIMS PRICED LESS CYLINDER)**

MODEL #	PRODUCT DESCRIPTION	605 606 613E 629 ¹ 630 ¹ BSP WSP
634F	Pull x Escutcheon – Dummy	\$518.00
651F	Escutcheon x Cylinder – Nightlatch	
656F	Lever x Escutcheon x Cylinder – Nightlatch AR-AU-CR-JN-MO-PB-PN-VI-HA*	\$749.00
658F	Lever x Escutcheon – Dummy AR-AU-CR-JN-MO-PB-PN-VI-HA*	
662F	Pull x Escutcheon x Cylinder – Nightlatch	\$518.00
673F	Pull x T.P. x Escutcheon x Cylinder – Classroom/Storeroom	\$653.00
675F	Pull x T.P. x Escutcheon – Dummy/T-Piece	

*See the Variations page for HA price add.

WITH REFLECTIONS® LEVER DESIGNS:

MODEL #	PRODUCT DESCRIPTION	605 606 613E 629 ¹ 630 ¹ BSP WSP
656F	Lever x Escutcheon x Cylinder – Nightlatch	\$749.00
658F	Lever x Escutcheon – Dummy Trim	

1. Escutcheon is plated to simulate Stainless Steel. See the Variations page for details.

NOTE: Cylinder reference indicates function only, all trims are **less cylinder**.
Cylinder rings/collars not furnished with trim if ordered less cylinder.

See Page 145 for cylinders are required.

When Ordering: Specify design and finish.

6200 SERIES NARROW STILE EXIT DEVICES

MODEL #	PRODUCT DESCRIPTION	613E 629 630 BSP WSP
PANIC EXIT DEVICES:		
6200	Rim Panic Rated	\$1,605.00
6250	SquareBolt® Panic	\$1,693.00
6210	SVR Panic Rated	\$1,930.00
6220	CVR Panic Rated	\$1,966.00

**TRIM
FOR 6200 SERIES RIM, SQUAREBOLT®, SVR, CVR EXITS
(ALL TRIMS PRICED LESS CYLINDER)**

MODEL #	PRODUCT DESCRIPTION	All Finishes
*121NL	Nightlatch Trim	\$85.00

Not recommended for VR exit devices. See page 145 for cylinder options.

When Ordering: Specify width, hand and finish.
Specify height for vertical rods.

**STANDARD DUTY OFFSET PULL TRIMS
FOR 6200 SERIES RIM, SQUAREBOLT® , SVR, CVR EXITS
(ALL TRIMS PRICED LESS CYLINDER)**

MODEL #	PRODUCT DESCRIPTION	605 606 613E 629 630 BSP WSP
480F	Offset Pull x Escutcheon (7-1/4")	\$657.00
481F	Offset Pull x Escutcheon x Cyl (7-1/4")	
482F	Offset Pull x Escutcheon (9")	
483F	Offset Pull x Esc x Cyl (9")	

**NARROW ESCUTCHEON TRIMS
FOR 6200 SERIES RIM, SQUAREBOLT® , SVR, CVR EXITS
(ALL TRIMS PRICED LESS CYLINDER)**

MODEL #	PRODUCT DESCRIPTION	605 606 611 612 613E 619 626 629 630 693 BSP WSP
500F	Blank Escutcheon	\$341.00
501F	Escutcheon x Cylinder	
503F	Thumbturn x Escutcheon x Cylinder	\$669.00
506F	Lever x Escutcheon x Cylinder AR-AU-CR-JN-MO-PB-PN-VI-HA*	\$883.00
507F	Thumbturn x Escutcheon	\$669.00
508F	Lever x Escutcheon AR-AU-CR-JN-MO-PB-PN-VI-HA*	\$883.00
509F	Lever x Escutcheon AR-AU-CR-JN-MO-PB-PN-VI-HA*	
512F	Pull x Escutcheon x Cylinder	\$392.00
513F	Pull x Escutcheon x Thumbturn x Cylinder	\$821.00
514F	Pull x Escutcheon	\$392.00
517F	Pull x Escutcheon x Thumbturn	\$821.00
518F	Pull x Escutcheon x Thumpiece x Cylinder	\$774.00
519F	Pull x Escutcheon x Thumpiece	

*See the Variations page for HA price add.

WITH REFLECTIONS® LEVER DESIGNS:

MODEL #	PRODUCT DESCRIPTION	605 606 613E 629 ¹ 630 ¹
506F	Lever x Escutcheon x Cylinder	\$883.00
508F	Lever x Escutcheon	
509F	Lever x Escutcheon	

NOTE: Cylinder reference indicates function only, all trims are **less cylinder**.
Cylinder rings/collars not furnished with trims ordered less cylinders.
See Page 145 for cylinders if required.

1. See the Variations page for details.

When Ordering: Specify design and finish.

6000 SERIES ELECTRIFIED EXIT DEVICES

ELECTRIFIED OPTIONS

MODEL #	EXIT DEVICE DESCRIPTION	A	A-ALR	B	O	P	S	SAFE	SECURE
6100(F)ED	Rim Exit Device (Wide)	x	x	x	x	x	x		
6130(F)ED	Mortise Exit Device (Wide)	x		x	x	x	x	x	x
6150(F)ED	Rim SquareBolt® Device (Wide)	x		x	x	x	x		
6160(F)ED	Concealed Vertical Rod (Wide)	x		x	x	x	x		
6170(F)ED	Surface Vertical Rod (Wide)	x		x	x	x	x		
6200	Rim Exit Device (Narrow)	x		x		x	x		
6210	Surface Vertical Rod (Narrow)	x		x		x	x		
6220	Concealed Vertical Rod (Narrow)	x		x		x	x		
6250	Rim SquareBolt® Device (Narrow)	x		x		x	x		

ELECTRIFIED OPTIONS:

OPTION	DESCRIPTION	LIST PRICE ADD
A	Alarm Kit (less cylinder)	\$1,137.00
A-ALR ¹	Alarm Kit (less cylinder) with red screen printed touchpad – only 36" length devices	\$1,137.00
B	Touchbar Monitoring or Signaling REX	\$358.00
MELR	Motor Latch Retraction	\$1,296.00
O	Trim Monitoring or Signaling	\$358.00
P	Latch Retraction	\$1,296.00
S	Latchbolt Status Monitoring or Signaling	\$381.00
SAFE	Mortise Device Lock with Outside Trim Control (Fail Unlock) – Lever Trims Only	\$1,167.00
SECURE	Mortise Device Lock with Outside Trim Control (Fail Lock) – Lever Trims Only	

¹ Only available with 6100ED and ED(F) in 36" and in BSP black finish.

Order options: 6100ED-A-ALR x 36" x BSP or 6100EDF-A-ALR x 36" x BSP

NOTE: Latchbolt status monitor required for 6170ED and 6210 series surface vertical rod exit devices with alarms.

Example: 6170EDAS x Door Width x Door Height x RHR x 630

ALARM KITS:

MODEL #	PRODUCT DESCRIPTION	LIST PRICE
6116-36	Alarm Kit (Less cylinder)	\$1,137.00
6116-48	Alarm Kit (Less cylinder)	
6216-36	Alarm Kit (Less cylinder)	

NOTE: The 6116 alarm kit cannot be retrofitted in the field to the 6170(F) or 6210 surface vertical rod exit devices. This option is available as a factory order only.

When Ordering: Specify design and finish.
Specify cylinder ring/collar size where required.

MODEL #	PRODUCT DESCRIPTION	*ALL FINISHES
RIM CYLINDERS FOR 480F, 500F, 620F, 630F, 680F, 690F SERIES AND 121NL NIGHTLATCH TRIM:		
1109	Standard Cylinder 6-Pin	\$108.00
1109	Standard Cylinder 7-Pin	\$110.00
1709	CMK Cylinder 6-Pin	\$124.00
1709	CMK Cylinder 7-Pin	\$126.00
1193	Large Format Interchangeable Core Cylinder 6-Pin	\$194.00
1193	Large Format Interchangeable Core Cylinder 7-Pin	\$196.00
5109	Security Cylinder 6-Pin	\$425.00
5109	Security Cylinder 7-Pin	\$429.00
U5109	High Security Cylinder 6-Pin	\$569.00
U5109	High Security Cylinder 7-Pin	\$573.00
5193	Security Large Format Interchangeable Core Cylinder 6-Pin	\$526.00
5193	Security Large Format Interchangeable Core Cylinder 7-Pin	\$530.00
K300	ACCENTRA KeyMark® Cylinder 6- or 7-Pin	\$136.00
K840	ACCENTRA KeyMark Large Format Interchangeable Core Cylinder 6-Pin or 7-Pin	\$234.00
K640	ACCENTRA KeyMark Small Format Interchangeable Core Cylinder 6- or 7-Pin	\$228.00
A640	Best® Keyway Small Format Interchangeable Core Cylinder 6- or 7-Pin	\$184.00
2109	Schlage® "C" Keyway Cylinder 6-Pin - 0-bitted or Keyed Random	\$108.00
MORTISE CYLINDERS FOR 650F, 660F, 670F, 680F SERIES TRIM & CYLINDER DOGGING:		
2153	Standard Cylinder 6-Pin	\$108.00
2153	Standard Cylinder 7-Pin	\$110.00
2196	Large Format Interchangeable Core Cylinder 6-Pin	\$194.00
2197	Large Format Interchangeable Core Cylinder 7-Pin	\$196.00
5153	Security Cylinder 6-Pin	\$425.00
5153	Security Cylinder 7-Pin	\$429.00
U5153	High Security Cylinder 6-Pin	\$569.00
U5153	High Security Cylinder 7-Pin	\$573.00
5196	Security Large Format Interchangeable Core Cylinder 6-Pin	\$526.00
5197	Security Large Format Interchangeable Core Cylinder 7-Pin	\$530.00
K100	ACCENTRA KeyMark® Cylinder 6- or 7-Pin	\$126.00
K820	ACCENTRA KeyMark Large Format Interchangeable Core Cylinder 6-Pin or 7-Pin	\$234.00
K620	ACCENTRA KeyMark Small Format Interchangeable Core Cylinder 6-Pin or 7-Pin	\$228.00
A620	Best® Keyway Small Format Interchangeable Core Cylinder 6- or 7-Pin	\$184.00

NOTE: Cylinder rings/collars furnished at no charge when ordered with cylinder.
Specify ring/collar size when ordering.

*Rim cylinders not available in 629 or 630 finishes.

When Ordering: Specify finish.
Specify cylinder ring/collar size where required.

CYLINDERS

MODEL #	PRODUCT DESCRIPTION	ADD TO TRIM	ORDERED SEPARATELY
COMPONENT CYLINDERS FOR 540F SERIES TRIM:			
1802	Standard Cylinder 6-Pin	STD	\$94.00
1802A	Standard Cylinder 7-Pin	\$2.00	\$96.00
5802	Security Cylinder 6-Pin	\$279.00	\$373.00
5802A	Security Cylinder 7-Pin	\$283.00	\$377.00
1210	Large Format Interchangeable Core Only 6-Pin	\$86.00	\$86.00
1220	Large Format Interchangeable Core Only 7-Pin	\$88.00	\$88.00
5210	Security Large Format Interchangeable Core Only 6-Pin	\$343.00	\$343.00
5220	Security Large Format Interchangeable Core Only 7-Pin	\$347.00	\$347.00
K402	ACCENTRA KeyMark® Cylinder	\$24.00	\$118.00
K800	ACCENTRA KeyMark® Large Format Interchangeable Core Only 6-or 7-Pin	\$126.00	\$126.00
K600	ACCENTRA KeyMark® Small Format Interchangeable Core Only 6-or 7-Pin	\$120.00	\$120.00
A600	Best® Keyway Small Format Interchangeable Core Only 6-or 7-Pin	\$76.00	\$76.00
2802	Schlage® "C" Keyway Cylinder 6-Pin - 0-bitted or Keyed Random	\$0.00	\$94.00
3804	Other Manuf. Keyway Cylinder 6-Pin - Keyed Random, Specify Keyway	\$24.00	\$118.00

ACCENTRA KeyMark® and Security products are priced separately. The cylinders are not discounted the same as the trim.

MISCELLANEOUS

MODEL #	PRODUCT DESCRIPTION	LIST PRICE
LONG SPINDLE KIT:		
81-9500-1665-000	2" – 2-1/2" door thickness for 620F and 630F series trim	\$57.00
81-9500-1635-000	2-1/2" – 3-1/2" door thickness for 620F and 630F series trim	\$119.00
81-9500-1636-000	3-1/2" – 4-1/2" door thickness for 620F and 630F series trim	

When Ordering: Specify finish.
Specify cylinder ring/collar size where required.

MODEL #	PRODUCT DESCRIPTION	ALL FINISHES
CYLINDER DOGGING KIT:		
615-L	Cylinder Dogging Kit (less cylinder) - 24", 36", 36" NS, 42", 42" NS, 48", 48" NS	\$255.00

MODEL #	PRODUCT DESCRIPTION	605 606 613E 629 630 BSP
DUMMY PUSH BAR:		
620 DB	Dummy Push Bar	\$1,012.00

MODEL #	PRODUCT DESCRIPTION	ORDERED W/ DEVICE ADD	ORDERED SEPARATELY
STRIKES (BLACK):			
702	Floor Strike (optional)	N/C	\$53.00
712	Strike for Overlapping Astragal (optional for 6130ED)	N/C	
718	Open Back Strike (optional)	\$181.00	\$234.00
726	Strike and Angle Bracket	N/C	\$103.00
757F	Rim Strike 6100(F)ED	N/C	\$97.00
759	Rim Strike, 6200	N/C	\$71.00
761	Top Strike Recessed 6160(F)ED	N/C	\$103.00
790	Floor Strike	N/C	\$53.00
791	Top Strike	N/C	\$103.00
793	Rim Strike (optional)	N/C	\$85.00
794	Bottom Flush Strike (optional)	N/C	\$53.00
797	Top Strike Bracket (SVR optional)	N/C	\$7.00
798	Mortise Strike	N/C	\$53.00
202	Strike Box (not finished, optional)	\$2.00	\$2.00

Note: "NS" = Narrow Stile

When Ordering: Specify finish.

MODEL #	PRODUCT DESCRIPTION	ALL FINISHES
MISC:		
60-7000-0815	Schlage® cam and housing assembly	\$32.00
1145VD	Tailpiece for 1109 cylinders to operate Von Duprin®	\$6.40

MODEL #	PRODUCT DESCRIPTION	606 626
MORTISE LOCKS:		
35LF	Mortise Lock Storeroom - Lever Trim	\$902.00
35KF	Mortise Lock Storeroom - Knob Trim	
35TF	Mortise Lock Storeroom - Thumbpiece Trim	
38LF	Mortise Lock Classroom - Lever Trim	
38KF	Mortise Lock Classroom - Knob Trim	
38TF	Mortise Lock Classroom - Thumbpiece Trim	

PRODUCT #	PRODUCT DESCRIPTION	ALL FINISHES
EXTENSIONS FOR 6000 SERIES VERTICAL RODS:		
7010-2	2" Extension	\$110.00
7010-6	6" Extension	\$126.00
7010-12	12" Extension	\$141.00
7010-24	24" Extension	\$167.00
DOGGING KEY: (size 5/16" - no finish)		\$2.00
DRILL JIG: (throw away - no finish)		

PRODUCT #	PRODUCT DESCRIPTION	BLACK
SHIM KITS TO CLEAR GLASS MOLDING:		
623SK	6100ED Series Rim, Mortise & CVR	\$158.00
623NS	6200 Series Rim & CVR	
624SK	6110ED, 6170ED Series SVR	\$216.00
624NS	6210 Series SVR	
ANTI-PRY:		
625AP	6100ED Rim and 6150ED SquareBolt® Anti-pry Bracket	\$81.00

PART #	PRODUCT DESCRIPTION	LIST PRICE
60-7000-9100-999	Plastic Installation Template used for installation of all 6100ED and 6200 Devices	\$5.10

When Ordering: Specify finish where required.

REMOVABLE MULLIONS

MODEL #	PRODUCT DESCRIPTION	600	628 695
REMOVABLE MULLIONS:			
M200	Steel Mullion - Panic Rated x 7'2"	\$956.00	-
M200F	Steel Mullion - 3 Hour Fire Rated x 7'2"	\$1,329.00	
M200F	Steel Mullion - 3 Hour Fire Rated x 10'	\$1,352.00	
M200SM	Split Mullion - Steel Panic Rated x 8'	\$1,213.00	
M300	Aluminum Mullion - Specify 8' or 10' (For 9' specify 10' and cut in field)	-	\$1,591.00
KEYED REMOVABLE MULLIONS:			
KRM200	Steel Mullion - Panic Rated x 7'2"	\$1,589.00	-
KRM200F	Steel Mullion - 1-1/2 Hour Fire Rated x 7'2"	\$1,919.00	
KRM200F	Steel Mullion - 1-1/2 Hour Fire Rated x 10'	\$1,944.00	
KRM200SM	Split Mullion - Steel Panic Rated x 8'	\$1,791.00	

NOTES:

Mullion Cylinder Kit not included with KRM Mullions. Must order separately.
Mullions longer than 8' must be ordered as fire rated option x 10' length. Fire rating is valid only up to 96".

MODEL	PRODUCT DESCRIPTION	LIST PRICE
MULLION CYLINDER KITS		
AMCK1	KRM200 - Steel Mullion - Panic Rated x 7'2"	\$108.00
	KRM200F - Steel Mullion - 1-1/2 Hour Fire Rated x 7'2" or 10'	
	KRM200SM - Split Mullion - Steel Panic Rated x 8'	

*Specify Finish and Cylinder Key Code when ordering
Ex: AMCK1 x FINISH x CYLINDER CODE (i.e. AMCK1 x 630 x CT6)

MODEL	PRODUCT DESCRIPTION	CYLINDER LENGTH	COLLAR SIZE		ALL FINISHES
			STD. MULLION / WS MULLION		
MORTISE CYLINDERS FOR KRM SERIES: (CYLINDERS ARE NOT INCLUDED WITH MULLIONS, MUST BE ORDERED SEPARATELY)					
2153	Standard Cylinder 6-Pin	1-1/8"	1765.312	1765.156	\$108.00
2153	Standard Cylinder 7-Pin	1-1/4"	1765.500	1765.250	\$110.00
2196	Large Format Interchangeable Core Cylinder 6-Pin	1-1/2"	1765.750	1765.500	\$194.00
2197	Large Format Interchangeable Core Cylinder 7-Pin	1-11/16"	1765.844	1765.719	\$196.00
5153	Security Cylinder 6-Pin	1-1/8"	1765.312	1765.156	\$425.00
5153	Security Cylinder 7-Pin	1-1/4"	1765.500	1765.250	\$429.00
5196	Security Large Format Interchangeable Core Cylinder 6-Pin	1-1/2"	1765.750	1765.500	\$526.00
5197	Security Large Format Interchangeable Core Cylinder 7-Pin	1-11/16"	1765.844	1765.719	\$530.00
K100	ACCENTRA KeyMark® Cylinder 6- or 7-Pin	1-1/8"	1765.312	1765.156	\$126.00
K100	ACCENTRA KeyMark® Cylinder 6- or 7-Pin	1-1/4"	1765.500	1765.250	
K100	ACCENTRA KeyMark® Cylinder 6- or 7-Pin	1-1/2"	1765.750	1765.500	
K820	ACCENTRA KeyMark® Large Format Interchangeable Core Cylinder 6-Pin	1-1/2"	1765.750	1765.500	\$234.00
K820	ACCENTRA KeyMark® Large Format Interchangeable Core Cylinder 7-Pin	1-11/16"	1765.844	1765.719	
K620	ACCENTRA KeyMark® Small Format Interchangeable Core Cylinder 6-Pin	1-1/4"	1765.500	1765.250	\$228.00
K620	ACCENTRA KeyMark® Small Format Interchangeable Core Cylinder 6- or 7-Pin	1-3-8"	1765.563	1765.500	
A620	Best® Keyway Small Format Interchangeable Core Cylinder 6-Pin	1-1/4"	1765.500	1765.250	\$184.00
A620	Best® Keyway Small Format Interchangeable Core Cylinder 6- or 7-Pin	1-3-8"	1765.563	1765.500	
2553*	Schlage® "C" Keyway Cylinder 6-Pin - 0-bitted or Keyed Random	1-1/8"	1765.312	1765.156	\$108.00

NOTE: Cylinder collars are furnished at no charge when ordered with cylinder. Specify collar size when ordering.
*2553 only available in 606, 612, 613 and 626 finishes.

PARTS AND ACCESSORIES

MODEL/PART #	PRODUCT DESCRIPTION	LIST PRICE
M102S	Mullion Stabilizer Kit (for M300)	\$127.00
M203	Door Frame Spacer Block	\$71.00
M204	Door Frame Angle Bracket	
60-7000-0750	Locking Mechanism for KRM200(F)	\$685.00
60-7000-0755	Top Retainer Pack for KRM200(F) and KRM200SM x 8'	\$298.00
60-7000-0759	Top Retainer Pack for M200(F) x 7' or 8' and M200SM x 8'	\$298.00
60-7000-0760	Bottom Retainer Pack for KRM200(F) and KRM200SM x 8'	\$198.00
60-7000-0763	Bottom Retainer Pack for M200(F) x 7' or 8' and M200SM x 8'	\$198.00
60-7000-0051	Split Mullion Socket Flat Head Screws for M200SM x 8' and KRM200SM x 8'	\$8.00
81-6419-2412-058	#8-32 X 1/2 Mullion Cyl. Set Screw	\$4.00

2100 SERIES EXIT DEVICES

DOOR WIDTHS: Prices are for standard sizes only. When ordering, suffix width as follows: 21X0-36, 21X0-42 or 21X0-48. No other sizes available.

VARIATIONS: Exit Devices and Trims are priced and ordered separately. In order to determine the full list price of a 2100 Series Exit Device with trim, it is necessary to add the list price of the device model number and the list price of the trim list number.

STANDARD FINISHES: Products will be furnished only in the following finishes.

ANSI/BHMA CODE	FINISH DESCRIPTION
EXIT DEVICES:	
613E	Dark Oxidized Satin Bronze - equivalent
630	Satin Stainless Steel
689	Aluminum Painted
691	Light Bronze Painted
693	Black Painted
695	Dark Bronze Painted
BSP	Black Suede Powder Coat

ANSI/BHMA CODE	FINISH DESCRIPTION
TRIMS:	
613E	Dark Oxidized Satin Bronze - equivalent
626	Satin Chrome Plated
630	Satin Stainless Steel
689	Aluminum Painted
691	Light Bronze Painted
693	Black Painted
695	Dark Bronze Painted
BSP	Black Suede Powder Coat
WSP	White Suede Powder Coat

CYLINDERS: Standard 6-Pin cylinders included with 440F, 580F Series Rose Trim only. All other keyed trim priced less cylinder, the list price of the cylinder must be added if cylinders are required. Specify cylinder and cylinder collar with collar size.

PRODUCT OPTIONS	ADD
DESIGNER LEVER: (HA)	\$360.00
DUST GUARD: Prefix "D" to model number (refer to catalog for available cylinders)	\$72.00
DOOR WIDTH:	
36" Door Width - Specify 21 X0-36	STD
42" Door Width - Specify 21 X0-42	\$0.00
48" Door Width - Specify 21 X0-48	\$74.00
"X" Specify "0" for Rim or "1" for Vertical Rod or "5" for SquareBolt®	
Door Thickness: Doors over 2-1/4"	\$64.00
SLEEVE NUTS: Factory orders only for exact quantity	
SN-104 (For interlock bracket on fire-rated mullions)	\$4.00
SN-134 (4 Pack)	\$9.70
TORX® SECURITY HEAD SCREWS: Standard size only	
Rim Exit Device	\$57.00
UL Rim Exit Device	
Surface Vertical Rod Exit Device (SVR)	\$149.00
Concealed Vertical Rod Exit Device (CVR)	\$57.00
630F Series Trim	\$0.00
121NL, 210F, 440F, 580F, 620F, 690F Series Trim	N/A
ABRASIVE COATING: On Touchbar Pad (ABCI)	\$114.00
MICROSHIELD®: Antimicrobial coating. Suffix YMS to model number for each exit device or trim that the coating will be applied.	\$119.00
REFLECTION LEVERS: The following levers are no longer available in 629 and 630 finishes, TT, TU, TW, TX, TY, UX, TG, TJ, TK, TE, TI and TD.	—

When Ordering: Specify finish where required.



2	1	X	0	Suffix	-XX	Finish	Other Info
		Third Digit: "0" - Rim Device, Pullman Latch "1" - SVR Device "5" - SquareBolt® Rim Security "7" - SVR Device	Fourth Digit: "0" - Standard	No Suffix - Panic label "F" - Fire exit device "WS" - Windstorm Certified Products ⁴	Size: (DOW=Door Opening Width) "36" - 30" - 36" (0.76m to 0.91m) DOW "42" - 36" to 42" (0.91m to 1.07m) DOW "48" - 42" to 48" (1.07m to 1.22m) DOW	613E 630 689 691 693 695 BSP	Door Hand - RHR or LHR (SVR or lever escutcheon trim only). Devices are field reversible. SN-134, 1/4-20 Sleeve Nuts (pack of 4). SN-104, 10-24 Sleeve Nuts (pack of 4). Door thickness: over 1-3/4" (45mm). Rod Extensions: (quantity) 2010-2 (quantity) 2010-6 (quantity) 2010-12 (quantity) 2010-24 Shim Kits: (quantity) 223 (quantity) 224 Optional Strike Bottom Pullman Latch (SVR devices) Removable Mullion: M200, Panic Exit M200F, Fire Exit Custom Cylinder & Cylinder Ring Factory Keying

- NOTE:**
1. Vertical rod exit devices are 7' standard.
 2. Panic Rated use rod extensions up to 10'.
 3. Fire Rated use rod extensions up to 8'.
 4. "WS" applies only to 2100(F) rim device. Contact Fleming-Baron Door Products for detailed frame/door requirements and limitations.

When Ordering: Specify design, hand and finish. Specify width for all exits and height for SVR.

2100 SERIES FLAT BAR EXIT DEVICE

OPTIONS			
BPL	Bottom Pullman Latch. Suffix BPL to 2110, 2120, 2160 & 2170 Panic Rated surface vertical rod exits.	ADD	\$47.00
LBR	Less Bottom Rod Suffix LBR to 2170 or 2160 only. 1-1/2 hr rating.		\$0.00
WIDE	Wide Style Latch Head Cover		\$0.00
WS	Windstorm certified. Suffix WS to 2100(F) rim device.  Hurricane		\$167.00
YMS	MicroShield® antimicrobial coating. Suffix YMS to model number for each exit device or trim that the coating will be applied.		\$119.00
Door Height over 8' to 10'	See catalog		\$156.00

MODEL #	PRODUCT DESCRIPTION	689 691 693 695	613E 630 BSP WSP	APPROX. SHIPPING WT. LBS.
RIM:				
2100	Panic Rated	\$618.00	\$939.00	11
2100WS	Panic Rated Windstorm Certified  Hurricane	\$785.00	\$1,106.00	11
2100F	Fire Rated	\$828.00	\$1,149.00	11
2100FWS	Fire Rated Windstorm Certified  Hurricane	\$995.00	\$1,316.00	11
SQUAREBOLT®:				
2150	Panic Rated	\$702.00	\$1,023.00	12
2150F	Fire Rated	\$912.00	\$1,233.00	12
SURFACE VERTICAL ROD:				
2110	Panic Rated	\$949.00	\$1,270.00	16
2110F	Fire Rated	\$1,159.00	\$1,480.00	16
2170	Panic Rated	\$1,020.00	\$1,341.00	16
2170F	Fire Rated	\$1,230.00	\$1,551.00	16
CONCEALED VERTICAL ROD:				
2120	Panic Rated	\$1,274.00	\$1,595.00	16
2120F	Fire Rated	\$1,484.00	\$1,805.00	16
2160	Panic Rated	\$1,401.00	\$1,722.00	16
2160F	Fire Rated	\$1,611.00	\$1,932.00	16

When Ordering: Specify design, hand and finish.
Specify width for all exits and height for SVR.

(ALL TRIMS PRICED LESS CYLINDER)

MODEL #	PRODUCT DESCRIPTION	689 691 695
213F	Escutcheon x Cylinder	\$102.00
214F	Pull Plate	
217F	Pull Plate x Cylinder	

MODEL #	PRODUCT DESCRIPTION	613E 626 ¹ 630 ¹ 693 BSP WSP
121NL ²	Nightlatch Trim	\$85.00
603F	Thumbturn x Escutcheon x Cylinder	\$613.00
620F	Blank Escutcheon Plate	\$518.00
621F	Escutcheon x Cylinder	
626F	Lever x Escutcheon x Cylinder AR-AU-CR-JN-MO-PB-PN-VI-HA*	\$749.00
627F	Lever x Escutcheon x Cylinder AR-AU-CR-JN-MO-PB-PN-VI-HA*	
628F	Lever x Escutcheon AR-AU-CR-JN-MO-PB-PN-VI-HA*	
629F	Lever x Escutcheon AR-AU-CR-JN-MO-PB-PN-VI-HA*	
630F	Blank Escutcheon Plate	\$334.00
631F	Escutcheon x Cylinder	
632F	Pull x Escutcheon x Cylinder	\$518.00
633F	Pull x T.P. x Escutcheon x Cylinder	\$653.00
634F	Pull x Escutcheon	\$518.00
635F	Pull x T.P. x Escutcheon	\$653.00

*See the Variations page for HA price add.

1. Escutcheon is plated to simulate Stainless Steel.
2. Not recommended for VR exit devices.

WITH REFLECTIONS® LEVER DESIGNS:

MODEL #	PRODUCT DESCRIPTION	613E 626 ¹ 630 ¹ BSP WSP
626F	Lever x Escutcheon x Cylinder	\$749.00
627F	Lever x Escutcheon x Cylinder	
628F	Lever x Escutcheon	
629F	Lever x Escutcheon	

1. Escutcheon is plated to simulate Stainless Steel.

NOTES: Cylinder reference indicates function only, all trims are **less cylinder**.
Cylinder rings/collars not furnished with trims ordered less cylinders.
See page 156 for cylinders if required.

MODEL #	PRODUCT DESCRIPTION	689 691 695	613E 626 693 BSP WSP
ROSE TRIMS: (Standard Cylinders Included)			
441F	AU-MO-PB Key-In-Lever – Nightlatch	\$226.00	\$252.00
446F	AU-MO-PB Key-In-Lever – Classroom		
448F	AU-MO-PB Active Lever – Dummy Free Wheeling	\$182.00	\$208.00
449F	AU-MO-PB Rigid Lever – Dummy Rigid		

440F trim available in 6 pin only. See 540F, page 118, if 7-pin required.

MODEL #	PRODUCT DESCRIPTION	689	613E 626 693 BSP WSP
ROSE x ESCUTCHEON TRIMS: (Standard Cylinders Included)			
581F	AU-MO-PB Key-In-Lever – Nightlatch	\$658.00	\$684.00
586F	AU-MO-PB Key-In-Lever – Classroom		
588F	AU-MO-PB Active Lever – Dummy Free Wheeling	\$564.00	\$590.00
589F	AU-MO-PB Rigid Lever – Dummy Rigid		

Note: Specified finish will apply to rose/lever finish only. Escutcheon provided in 689 (Aluminum Painted) finish for all.

MODEL #	PRODUCT DESCRIPTION	613E 626' 630' 693 BSP WSP
ELECTRIFIED TRIM: (Trims Priced Less Cylinder)		
690F	Lever x Escutcheon x Cylinder x Fail Safe AR-AU-CR-JN-MO-PB-PN-VI-HA*	\$1,763.00
691F	Lever x Escutcheon x Cylinder x Fail Secure AR-AU-CR-JN-MO-PB-PN-VI-HA*	
SM	SPDT Lock and Unlock Monitor Switch	\$455.00
EX	Trim Gasket for Exterior Applications	\$45.00

*See the Variations page for HA price add.
1. Escutcheon is plated to simulate Stainless Steel.

WITH REFLECTIONS® LEVER DESIGNS:

MODEL #	PRODUCT DESCRIPTION	613E 626' 630' BSP WSP
ELECTRIFIED TRIM: (Trims Priced Less Cylinder)		
690F	Lever x Escutcheon x Cylinder x Fail Safe	\$1,763.00
691F	Lever x Escutcheon x Cylinder x Fail Secure	

1. Escutcheon is plated to simulate Stainless Steel.

OPTIONS			
B-	Prefix for SFIC core prep Key-In-Lever Trim Available with AU, MO, and PB levers.	ADD	\$0.00
M-	Prefix for Medeco®/ASSA® IC Core Prep Key-In-Lever Trim Available with AU levers.		\$0.00
S-	Prefix for Schlage® cylinder prep Key-In-Lever Trim Available with AU, MO, and PB levers.		\$0.00
SI-	Prefix for Schlage® IC Core Prep Key-In-Lever Trim. Available with AU, MO, and PB levers.		

See page 156 for cylinders if required.

MODEL #	PRODUCT DESCRIPTION	*ALL FINISHES
RIM CYLINDERS FOR 210F, 620F, 630F, 690F SERIES AND 121NL NIGHTLATCH TRIM:		
1109	Standard Cylinder 6-Pin	\$108.00
1109	Standard Cylinder 7-Pin	\$110.00
1709	CMK Cylinder 6-Pin	\$124.00
1709	CMK Cylinder 7-Pin	\$126.00
1193	Large Format Interchangeable Core Cylinder 6-Pin	\$194.00
1193	Large Format Interchangeable Core Cylinder 7-Pin	\$196.00
5109	Security Cylinder 6-Pin	\$425.00
5109	Security Cylinder 7-Pin	\$429.00
U5109	High Security Cylinder 6-Pin	\$569.00
U5109	High Security Cylinder 7-Pin	\$573.00
5193	Security Large Format Interchangeable Core Cylinder 6-Pin	\$526.00
5193	Security Large Format Interchangeable Core Cylinder 7-Pin	\$530.00
K300	ACCENTRA KeyMark® Cylinder 6- or 7-Pin	\$136.00
K840	ACCENTRA KeyMark Large Format Interchangeable Core Cylinder 6-Pin or 7-Pin	\$234.00
K640	ACCENTRA KeyMark Small Format Interchangeable Core Cylinder 6- or 7-Pin	\$228.00
A640	Best® Keyway Small Format Interchangeable Core Cylinder 6- or 7-Pin	\$184.00
2109	Schlage® "C" Keyway Cylinder 6-Pin - 0-bitted or Keyed Random	\$108.00

NOTES: Cylinder Rings/Collars no charge if ordered with cylinder.
Specify ring/collar and size when ordering.
*Rim cylinders not available in 630 finish.

MODEL #	PRODUCT DESCRIPTION	ADD TO TRIM	ORDERED SEPARATELY
COMPONENT CYLINDERS FOR 440F, 580F SERIES TRIM:			
1802	Standard Cylinder 6-Pin for Lever Designs	N/C	\$94.00
1802A	Standard Cylinder 7-Pin for Lever Designs	\$2.00	\$96.00
5802	Security Cylinder 6-Pin for Lever Designs	\$279.00	\$373.00
5802A	Security Cylinder 7-Pin for Lever Designs	\$283.00	\$377.00
1210	Large Format Interchangeable Core Only 6-Pin	\$86.00	\$86.00
1220	Large Format Interchangeable Core Only 7-Pin	\$88.00	\$88.00
5210	Security Large Format Interchangeable Core Only 6-Pin	\$343.00	\$343.00
5220	Security Large Format Interchangeable Core Only 7-Pin	\$347.00	\$347.00
K402	ACCENTRA KeyMark® Cylinder for Lever Designs	\$23.00	\$24.00
K800	ACCENTRA KeyMark® Large Format Interchangeable Core Only 6-or 7-Pin	\$126.00	\$126.00
K600	ACCENTRA KeyMark® Small Format Interchangeable Core Only 6-or 7-Pin	\$120.00	\$120.00
A600	Best® Keyway Small Format Interchangeable Core Only 6-or 7-Pin	\$76.00	\$76.00
2802	Schlage® "C" Keyway Cylinder 6-Pin - 0-bitted or Keyed Random for Lever Designs	N/C	\$94.00
3804	Other Manuf. Keyway Cylinder 6-Pin - Keyed Random, Specify Keyway for Lever Designs	\$24.00	\$118.00

440F trim available in 6 pin only. See 540F in 7000 series section if 7-pin required.
ACCENTRA KeyMark® and Security products are priced separately. The cylinders are not discounted the same as the trim.

When Ordering: Specify design, hand and finish.

2100 SERIES MISCELLANEOUS

MODEL #	PRODUCT DESCRIPTION	BLACK
STRIKES:		
702	V.R. Bottom Strike for Pullman Latch (optional)	\$53.00
757F	Rim Strike (Panic and Fire Devices)	\$97.00
757FWS	Rim Strike for Windstorm Devices 2100(F)WS  Hurricane	\$137.00
790	V.R. Bottom Strike for Deadbolt	\$53.00
791	V.R. Top Roller Strike	\$103.00
793	Rim Strike for Doors Pairs (optional)	\$85.00
794	V.R. Bottom Strike for Deadbolt (optional)	\$53.00
797	V.R. Top Bracket (optional)	\$7.00
SHIM KITS TO CLEAR GLASS MOLDINGS:		
223	1/4" Shim Kit for Rim Device	\$88.00
224	1/4" Shim Kit for V.R. Device	\$133.00









MODEL #	PRODUCT DESCRIPTION	689 691 693 695	605 606 612 613E 630 BSP WSP
EXTENSION RODS:			
2010-2	2" Extension	\$64.00	\$93.00
2010-6	6" Extension	\$82.00	\$111.00
2010-12	12" Extension	\$100.00	\$129.00
2010-24	24" Extension (2170 only)	\$125.00	\$154.00

PART #	DESCRIPTION	LIST PRICE
60-7000-1131	Dogging Key	\$2.00
60-7000-9100	Plastic Installation Template used for installation of all 2100 Devices	\$5.10

NOTE: See page 208 for power supplies and electrified accessories.

When Ordering: Specify finish where required.

REMOVABLE MULLIONS

MODEL #	PRODUCT DESCRIPTION	600	628 695
REMOVABLE MULLIONS:			
M200	Steel Mullion - Panic Rated x 7'2"	\$956.00	-
M200F	Steel Mullion - 3 Hour Fire Rated x 7'2"	\$1,329.00	
M200F	Steel Mullion - 3 Hour Fire Rated x 10'	\$1,352.00	
M200FWS	Steel Mullion - 3 Hour Fire Rated, Windstorm Certified x 7'2"*  	\$1,825.00	
M200FWS	Steel Mullion - 3 Hour Fire Rated, Windstorm Certified x 8"*  	\$1,852.00	
M200SM	Split Mullion - Steel Panic Rated x 8'	\$1,155.00	
M300	Aluminum Mullion - Specify 8' or 10' (For 9' specify 10' and cut in field)	-	\$1,591.00
KEYED REMOVABLE MULLIONS:			
KRM200	Steel Mullion - Panic Rated x 7'2"	\$1,589.00	-
KRM200F	Steel Mullion - 1-1/2 Hour Fire Rated x 7'2"	\$1,919.00	
KRM200F	Steel Mullion - 1-1/2 Hour Fire Rated x 10'	\$1,944.00	
KRM200FWS	Steel Mullion - 3 Hour Fire Rated, Windstorm Certified x 7'2"*  	\$2,382.00	
KRM200FWS	Steel Mullion - 3 Hour Fire Rated, Windstorm Certified x 8'  	-	
KRM200SM	Split Mullion - Steel Panic Rated x 8'	\$1,791.00	

*For use with UL Listed door assemblies that comply to FEMA 361 and ICC 500

NOTES:

Mullion Cylinder Kit not included with KRM Mullions. Must order separately.

Mullions longer than 8' must be ordered as fire rated option x 10' length. Fire rating is valid only up to 96".

MODEL	PRODUCT DESCRIPTION	LIST PRICE
MULLION CYLINDER KITS		
AMCK1	KRM200 - Steel Mullion - Panic Rated x 7'2"	\$108.00
	KRM200F - Steel Mullion - 1-1/2 Hour Fire Rated x 7'2" or 10'	
	KRM200SM - Split Mullion - Steel Panic Rated x 8'	
AMCK2	KRM200FWS - Steel Mullion - 3 Hour Fire Rated, Windstorm Certified x 7'2" or 8'	

*Specify Finish and Cylinder Key Code when ordering

Ex: AMCK1 x FINISH x CYLINDER CODE (i.e. AMCK1 x 630 x CT6)

MODEL	PRODUCT DESCRIPTION	CYLINDER LENGTH	COLLAR SIZE	ALL FINISHES
			STD. MULLION	
MORTISE CYLINDERS FOR KRM SERIES: (CYLINDERS ARE NOT INCLUDED WITH MULLIONS, MUST BE ORDERED SEPARATELY)				
2153	Standard Cylinder 6-Pin	1-1/8"	1765.312	\$108.00
2153	Standard Cylinder 7-Pin	1-1/4"	1765.500	\$110.00
2196	Large Format Interchangeable Core Cylinder 6-Pin	1-1/2"	1765.750	\$194.00
2197	Large Format Interchangeable Core Cylinder 7-Pin	1-11/16"	1765.844	\$196.00
5153	Security Cylinder 6-Pin	1-1/8"	1765.312	\$425.00
5153	Security Cylinder 7-Pin	1-1/4"	1765.500	\$429.00
5196	Security Large Format Interchangeable Core Cylinder 6-Pin	1-1/2"	1765.750	\$526.00
5197	Security Large Format Interchangeable Core Cylinder 7-Pin	1-11/16"	1765.844	\$530.00
K100	ACCENTRA KeyMark® Cylinder 6- or 7-Pin	1-1/8"	1765.312	\$126.00
K100	ACCENTRA KeyMark® Cylinder 6- or 7-Pin	1-1/4"	1765.500	
K100	ACCENTRA KeyMark® Cylinder 6- or 7-Pin	1-1/2"	1765.750	
K820	ACCENTRA KeyMark® Large Format Interchangeable Core Cylinder 6-Pin	1-1/2"	1765.750	\$234.00
K820	ACCENTRA KeyMark® Large Format Interchangeable Core Cylinder 7-Pin	1-11/16"	1765.844	
K620	ACCENTRA KeyMark® Small Format Interchangeable Core Cylinder 6-Pin	1-1/4"	1765.500	\$228.00
K620	ACCENTRA KeyMark® Small Format Interchangeable Core Cylinder 6- or 7-Pin	1-3-8"	1765.563	
A620	Best® Keyway Small Format Interchangeable Core Cylinder 6-Pin	1-1/4"	1765.500	\$184.00
A620	Best® Keyway Small Format Interchangeable Core Cylinder 6- or 7-Pin	1-3-8"	1765.563	
2553*	Schlage® "C" Keyway Cylinder 6-Pin - 0-bitted or Keyed Random	1-1/8"	1765.312	\$108.00

NOTE: Cylinders ordered separately, not included with KRM mullions

*2553 only available in 606, 612, 613 and 626 finishes.

MODEL/PART #	PRODUCT DESCRIPTION	LIST PRICE
M203	Door Frame Spacer Block	\$71.00
M204	Door Frame Angle Bracket	
60-7000-0750	Locking Mechanism for KRM200(F)	\$685.00
60-7000-0755	Top Retainer Pack for KRM200(F) and KRM200SM x 8'	\$298.00
60-7000-0759	Top Retainer Pack for M200(F) x 7' or 8' and M200SM x 8'	\$298.00
60-7000-0760	Bottom Retainer Pack for KRM200(F) and KRM200SM x 8'	\$198.00
60-7000-0763	Bottom Retainer Pack for M200(F) x 7' or 8' and M200SM x 8'	\$198.00
60-7000-0051	Split Mullion Socket Flat Head Screws for M200SM x 8' and KRM200SM x 8'	\$8.00
81-6419-2412-058	#8-32 X 1/2" Mullion Cyl. Set Screw	\$4.00

When Ordering: Specify finish where required.

1800 SERIES GRADE 1 EXIT DEVICES

DOOR WIDTHS: Prices are for standard sizes only. When ordering, suffix width as follows: 18X0-36, 18X0-42 or 18X0-48. No other sizes available.

VARIATIONS: Exit Devices and Trims are priced and ordered separately. In order to determine the full list price of a 1800 Series Exit Device with trim, it is necessary to add the list price of the device model number and the list price of the trim model number.

STANDARD FINISHES: Products will be furnished only in the following finishes.

ANSI/BHMA CODE	FINISH DESCRIPTION
EXIT DEVICES:	
689	Aluminum Painted
691	Light Bronze Painted
693	Black Painted
695	Dark Bronze Painted

ANSI/BHMA CODE	FINISH DESCRIPTION
TRIMS:	
626	Satin Chrome Plated
630	Satin Stainless Steel
689	Aluminum Painted
691	Light Bronze Painted
693	Black Painted
695	Dark Bronze Painted

CYLINDERS: Standard 6-Pin cylinders included with 440F Series Rose Trim only. All other keyed trim priced less cylinder, the list price of the cylinder must be added if cylinders are required. Specify cylinder and cylinder collar with collar size.

PRODUCT DESCRIPTION	ADD
DOOR WIDTH:	
36" Door Width - Specify 18 X 0-36	STD
42" Door Width - Specify 18 X 0-42	\$0.00
48" Door Width - Specify 18 X 0-48	\$74.00
"X" Specify "0" for Rim or "1" for Vertical Rod	
Door Thickness: Doors over 2-1/4"	\$64.00
SLEEVE NUTS: Factory orders only for exact quantity	
SN-104 (For interlock bracket on fire-rated mullions)	\$4.00
SN-134 (4 Pack)	\$9.70
TORX® SECURITY HEAD SCREWS: Standard size only	
Rim Exit Device	\$57.00
UL Rim Exit Device	
Vertical Rod Exit Device	\$149.00
UL Vertical Rod Exit Device	
420F Series	\$7.00
210F, 440F Series Trim	N/A

1800 SERIES EXIT DEVICE HOW TO ORDER

1	8	X	0	Suffix	-XX	Finish	Other Info
		Third Digit: "0" - Rim Device "1" - SVR Device		No Suffix - Panic label "F" - Fire exit device	Size: (DOW=Door Opening Width) "36" - 30" - 36" (76cm to 91cm) DOW "42" - 36" to 42" (91cm to 107cm) DOW "48" - 42" to 48" (107cm to 122cm) DOW	689 691 693 695	Door Hand - RHR or LHR (SVR or lever escutcheon trim only). Devices are field reversible. SN-134, 1/4-20 Sleeve Nuts (pack of 4). SN-104, 10-24 Sleeve Nuts (pack of 4). Door thickness: over 1-3/4" (45mm). Rod Extensions: (quantity) 2010-2 (quantity) 2010-6 (quantity) 2010-12 Shim Kits: (quantity) 223 (quantity) 224 Optional Strike Bottom Pullman Latch (SVR device) Removable Mullion: M200 (Panic) M200F (Fire) KRM200 (Panic) KRM200F (Fire) M200SM (Panic) KRM200SM (Panic) Custom Cylinder & Cylinder Ring Factory Keying

NOTE: Vertical rod exit devices are 7' standard.
Panic and Fire Rated use rod extensions up to 8'.

When Ordering: Specify design, hand and finish.
Specify width for all exits and height for SVR.

1800 SERIES GRADE 1 FLAT BAR EXIT DEVICE

MODEL #	PRODUCT DESCRIPTION	689 691 693 695	APPROX. SHIPPING WT. LBS.
RIM:			
1800	Panic Rated	\$347.00	11
1800F	Fire Rated	\$447.00	11
SURFACE VERTICAL ROD:			
1810*	Panic Rated	\$484.00	16
1810F	Fire Rated	\$584.00	16
* Bottom Pullman Latch (Not for Fire Rated)		\$47.00	—

1800 SERIES EXIT DEVICE TRIMS

MODEL #	PRODUCT DESCRIPTION	689 691 693 695	630
213F	Escutcheon x Cylinder – Nightlatch	\$102.00	—
214F	Pull Plate – Dummy Trim		
217F	Pull Plate x Cylinder – Dummy Trim		
420F	Blank Escutcheon Plate – Exit Only	\$281.00	\$307.00
421F	Escutcheon x Cylinder – Nightlatch		
426F	Lever x Escutcheon x Cylinder AU-MO-PB – Classroom/Storeroom	\$391.00	\$417.00
427F	Lever x Escutcheon x Cylinder AU-MO-PB – Classroom/Storeroom		
428F	Lever x Escutcheon AU-MO-PB – Dummy Trim		
429F	Lever x Escutcheon AU-MO-PB – Dummy Trim		

NOTE: Cylinder reference indicates function only, all trims are **less cylinder**.
Cylinder rings/collars not furnished with trims ordered less cylinders.

MODEL #	PRODUCT DESCRIPTION	689 691 695	626 693
ROSE TRIMS: (Standard Cylinders Included)			
441F	AU-MO-PB Key-In-Lever	\$226.00	\$252.00
446F	AU-MO-PB Key-In-Lever		
448F	AU-MO-PB Active Lever	\$182.00	\$208.00
449F	AU-MO-PB Rigid Lever		

MODEL #	PRODUCT DESCRIPTION	ALL FINISHES
RIM CYLINDERS FOR 210F, 420F SERIES TRIM:		
1109	Standard Cylinder 6-Pin	\$108.00
1709	CMK Cylinder 6-Pin	\$124.00
A640	Best® Keyway Small Format Interchangeable Core Cylinder 6- or 7-Pin	\$184.00
2109	Schlage® "C" Keyway Cylinder 6-Pin - 0-bitted or Keyed Random	\$108.00

NOTE: Cylinder Rings/Collars no charge if ordered with cylinder.
Specify ring/collar and size when ordering.

MODEL #	PRODUCT DESCRIPTION	ADD TO TRIM	606 626
COMPONENT CYLINDERS FOR 440F SERIES TRIM:			
1802	Standard Cylinder 6-Pin	\$0.00	\$94.00
A600	Best® Keyway Small Format Interchangeable Core Only 6-or 7-Pin	\$76.00	\$76.00
2802	Schlage® "C" Keyway Cylinder 6-Pin - 0-bitted or Keyed Random	\$0.00	\$94.00

OPTION			
B-	Prefix for SFIC Core Prep for Key-in-Lever Trim, Less Core	ADD	\$0.00

MODEL #	PRODUCT DESCRIPTION	BLACK
RETROFIT KIT:		
ECK2	Replacement Metal End Cap	\$64.00
STRIKES:		
702	V.R. Bottom Strike for Pullman Latch (Optional)	\$53.00
757F	Rim Strike (Panic and Fire Devices)	\$97.00
790	V.R. Bottom Strike for Deadbolt	\$53.00
791	V.R. Top Roller Strike	\$103.00
793	Rim Strike for Doors Pairs (optional)	\$85.00
794	V.R. Bottom Strike for Deadbolt (optional)	\$53.00
797	V.R. Top Bracket (optional)	\$7.00
SHIM KITS TO CLEAR GLASS MOLDINGS:		
223	1/4" Shim Kit for Rim Device	\$88.00
224	1/4" Shim Kit for V.R. Device	\$133.00

MODEL #	PRODUCT DESCRIPTION	689 691 693 695
EXTENSION RODS:		
2010-2	2" Extension	\$64.00
2010-6	6" Extension	\$82.00
2010-12	12" Extension	\$100.00
DOGGING KEY 60-7000-1131: (no finish)		\$2.00

MULLIONS

MODEL #	PRODUCT DESCRIPTION	600
REMOVABLE MULLIONS:		
M200	Steel Mullion - Panic Rated x 7'2"	\$956.00
M200F	Steel Mullion - 3 Hour Fire Rated x 7'2"	\$1,329.00
M200F	Steel Mullion - 3 Hour Fire Rated x 10'	\$1,352.00
M200SM	Split Mullion - Steel Panic Rated x 8'	\$1,213.00
KEYED REMOVABLE MULLIONS:		
KRM200	Steel Mullion - Panic Rated x 7'2"	\$1,589.00
KRM200F	Steel Mullion - 1-1/2 Hour Fire Rated x 7'2"	\$1,919.00
KRM200SM	Split Mullion - Steel Panic Rated x 8'	\$1,791.00

NOTES:

Mullion Cylinder Kit not included with KRM Mullions. Must order separately.
Mullions longer than 8' must be ordered as fire rated option x 10' length. Fire rating is valid only up to 96".

MODEL	PRODUCT DESCRIPTION	LIST PRICE
MULLION CYLINDER KITS		
AMCK1	KRM200 - Steel Mullion - Panic Rated x 7'2"	\$108.00
	KRM200F - Steel Mullion - 1-1/2 Hour Fire Rated x 7'2" or 10'	
	KRM200SM - Split Mullion - Steel Panic Rated x 8'	

*Specify Finish and Cylinder Key Code when ordering

Ex: AMCK1 x FINISH x CYLINDER CODE (i.e. AMCK1 x 630 x CT6)

MODEL	PRODUCT DESCRIPTION	CYLINDER LENGTH	COLLAR SIZE	ALL FINISHES
MORTISE CYLINDERS FOR KRM SERIES: (Cylinders are not included with mullions, must be ordered separately)				
2153	Standard Cylinder 6-Pin	1-1/8"	1765.312	\$108.00
A620	Best® Keyway Small Format Interchangeable Core Cylinder 6-Pin	1-1/4"	1765.500	\$184.00
A620	Best® Keyway Small Format Interchangeable Core Cylinder 6- or 7-Pin	1-3/8"	1765.563	
2553*	Schlage® "C" Keyway Cylinder 6-Pin - 0-bitted or Keyed Random	1-1/8"	1765.312	\$108.00

NOTE: Cylinder collars are furnished at no charge when ordered with cylinder. Specify collar size when ordering.

*2553 only available in 606, 612, 613 and 626 finishes.

MODEL/PART #	PRODUCT DESCRIPTION	LIST PRICE
M203	Door Frame Spacer Block	\$71.00
M204	Door Frame Angle Bracket	
60-7000-0750	Locking Mechanism for KRM200(F)	\$685.00
60-7000-0755	Top Retainer Pack for KRM200(F) and KRM200SM x 8'	\$298.00
60-7000-0759	Top Retainer Pack for M200(F) x 7' or 8' and M200SM x 8'	\$298.00
60-7000-0760	Bottom Retainer Pack for KRM200(F) and KRM200SM x 8'	\$198.00
60-7000-0763	Bottom Retainer Pack for M200(F) x 7' or 8' and M200SM x 8'	\$198.00
81-6419-2412-058	#8-32 X 1/2 Mullion Cyl. Set Screw	\$4.00

1500 SERIES EXIT DEVICES

VARIATIONS: Exit devices and Trim are priced and ordered separately. In order to determine the full list price of a 1500 series device with trim, it is necessary to add the list price of the device model number and the list price of the trim model number.

STANDARD FINISHES: Products will be furnished only in the following finishes.

ANSI/BHMA CODE	FINISH DESCRIPTION
BRASS:	
605	Bright Brass, Clear Coated
606	Satin Brass, Clear Coated
BRONZE:	
611	Bright Bronze, Clear Coated
612	Satin Bronze, Clear Coated
613E	Dark Oxidized Satin Bronze - equivalent

ANSI/BHMA CODE	FINISH DESCRIPTION
CHROME:	
626	Satin Chrome Plated
NICKEL:	
619	Satin Nickel Plated, Clear Coated
STAINLESS STEEL:	
629	Bright Stainless Steel
630	Satin Stainless Steel
PAINTED:	
693	Black Painted
BSP	Black Suede Powder Coat
WSP	White Suede Powder Coat

CYLINDERS: Keyed trim priced less cylinder, the list price of the cylinder must be added if cylinders are required. Specify cylinder and cylinder collar with collar size.

PRODUCT DESCRIPTION	ADD
DUST GUARD: Prefix "D" to model number (refer to catalog for available cylinders)	\$72.00
SLEEVE NUTS: Factory orders only for exact quantity	
Rim, Mortise and CVR	\$23.00
UL Rim, Mortise and CVR	\$39.00
Surface Vertical Rod (SVR)	\$39.00
UL Surface Vertical Rod (SVR)	\$39.00
REINFORCED CROSSBAR:	\$77.00
48" CROSSBAR	\$87.00
ABRASIVE COATING: On Crossbar (ABC)	\$77.00
Door Thickness: Doors over 2-1/4"	\$64.00
REFLECTION LEVERS: The following levers are no longer available in 629 and 630 finishes, TT, TU, TW, TX, TY, UX, TG, TJ, TK, TE, TI and TD.	—

When Ordering: Specify design, hand and finish.

1500 SERIES EXIT DEVICES - HOW TO ORDER

15	X	0	Suffix	Size	Finish	Other Info
	Third Digit: "0" - Rim Device "1" - SVR Device "2" - CVR Device "3" - Mortise Device		Mechanical Feature: "F" Fire Exit Device "K5" Mortise Device, EO or Entry by Key with/without Rigid Knob. "K8" Mortise Device, Entry by Knob. "L5" Mortise Device, Entry by Key with/without Rigid Lever. "L8" Mortise Device, Entry by Lever. "T5" Mortise Device with Thumbpiece Trim "T8" Mortise Device, Active Thumbpiece Trim.	Size: (DOW=Door Opening Width) "36" 30" to 36" DOW "48" 36" to 48" DOW	See Page 165	Other Information: Door Hand All devices and lever handle trim. Door Thickness over 1-3/4" (45mm). Fastener Options Torx® security screws, SNB (wood, composite or unreinforced metal doors). Specialty Cylinders & Components

NOTE: Vertical rod exit devices are 7' standard.
 Panic Rated use rod extensions up to 10'.
 Fire Rated use rod extensions up to 8'.

When Ordering: Specify width, hand and finish.
 Specify height for vertical rods.

1500 SERIES EXIT DEVICES

MODEL #	PRODUCT DESCRIPTION	605 606 611 612 613E
		619 626 629 630 693 BSP WSP
RIM:		
1500	Panic Rated	\$2,669.00
1500F	Fire Rated	\$2,920.00
SURFACE VERTICAL ROD:		
1510	Panic Rated	\$3,152.00
1510F	Fire Rated	\$3,403.00
CONCEALED VERTICAL ROD:		
1520	Panic Rated	\$3,356.00
1520F	Fire Rated	\$3,607.00
MORTISE:		
1530	Panic Rated	\$3,019.00
1530F	Fire Rated	\$3,270.00
OPTION:		
Bottom Pullman Latch for 1510 SVR Exit Device		ADD \$47.00

When Ordering: Specify width, hand and finish.
Specify height for vertical rods.

**ESCUTCHEON TRIMS
FOR 1500 SERIES RIM, VERTICAL ROD AND CVR DEVICES
(ALL TRIMS PRICED LESS CYLINDER)**

MODEL #	PRODUCT DESCRIPTION	605 606 611 ² 612 613E 619 626 ¹ 629 ¹ 630 ¹ 693 BSP WSP					
		620F	Blank Escutcheon	\$518.00			
621F	Escutcheon x Cylinder						
626F	Lever x Escutcheon x Cylinder AR-AU-CR-JN-MO-PB-PN-VI-HA*	\$749.00					
627F	Lever x Escutcheon x Cylinder AR-AU-CR-JN-MO-PB-PN-VI-HA*						
628F	Lever x Escutcheon AR-AU-CR-JN-MO-PB-PN-VI-HA*						
629F	Lever x Escutcheon AR-AU-CR-JN-MO-PB-PN-VI-HA*						
630F	Blank Escutcheon	\$334.00					
631F	Escutcheon x Cylinder						
632F	Pull x Escutcheon x Cylinder	\$518.00					
633F	Pull x T.P. x Escut. x Cyl.	\$653.00					
634F	Pull x Escutcheon	\$518.00					
635F	Pull x T.P. x Escutcheon	\$653.00					

*See the Variations page for HA price add.

1. Escutcheon is plated to simulate Stainless Steel.
2. 611 finish is not available on 630, 660 and 670 Series Trims.

WITH REFLECTIONS® LEVER DESIGNS:

MODEL #	PRODUCT DESCRIPTION	605 606 611 612 613E 619 626 ¹ 629 ¹ 630 ¹ BSP WSP					
		626F	Lever x Escutcheon x Cylinder	\$749.00			
627F	Lever x Escutcheon x Cylinder						
628F	Lever x Escutcheon						
629F	Lever x Escutcheon						

1. Escutcheon is plated to simulate Stainless Steel. See the Variations page for details.

NOTE: Cylinder reference indicates function only, all trims are **less cylinder**.
See Page 170 if cylinders are required.

When Ordering: Specify design and finish.

**ESCUTCHEON TRIMS
FOR 1530 SERIES MORTISE DEVICES
(ALL TRIMS PRICED LESS CYLINDER)**

MODEL #	PRODUCT DESCRIPTION	605 606 611 ² 612 613E 619 626 ¹ 629 ¹ 630 ¹ 693 BSP WSP
620F	Blank Escutcheon – Exit Only - Lever/Knob Prep	\$518.00
630F	Blank Escutcheon – Exit Only - Pull Handle Prep	\$334.00
634F	Pull x Escutcheon – Dummy Trim Pull Plate	\$518.00
651F	Escutcheon x Cylinder – Nightlatch	
356F	Lever x Escutcheon x Cylinder – Classroom AR-AU-CR-JN-MO-PB-PN-VI-HA ³	\$749.00
358F	Lever x Escutcheon – Passage and Dummy Rigid Lever AR-AU-CR-JN-MO-PB-PN-VI-HA ³	
661F	Escutcheon x Cylinder – Nightlatch	\$334.00
662F	Pull x Escutcheon x Cylinder – Nightlatch x Pull	\$518.00
673F	Pull x T.P. x Escutcheon x Cylinder – Classroom/T-Piece	\$653.00
675F	Pull x T.P. x Escutcheon – Passage/T-Piece	

WITH REFLECTIONS® LEVER DESIGNS:

MODEL #	PRODUCT DESCRIPTION	605 606 611 612 613E 619 626 ¹ 629 ¹ 630 ¹ BSP WSP
356F	Lever x Escutcheon x Cylinder – Classroom	\$749.00
358F	Lever x Escutcheon – Passage and Dummy Rigid Lever	

1. Escutcheon is plated to simulate Stainless Steel. See the Variations page for details.
2. 611 finish is not available on 630, 660 and 670 Series Trims.
3. See page 161 for HA lever add

NOTE: Cylinder reference indicates function only, all trims are **less cylinder**.
See Page 170 for cylinders if cylinders are required.

When Ordering: Specify design, hand and finish.

MODEL #	PRODUCT DESCRIPTION	*ALL FINISHES
RIM CYLINDERS FOR 620F, 630F SERIES TRIM:		
1109	Standard Cylinder 6-Pin	\$108.00
1109	Standard Cylinder 7-Pin	\$110.00
1709	CMK Cylinder 6-Pin	\$124.00
1709	CMK Cylinder 7-Pin	\$126.00
1193	Large Format Interchangeable Core Cylinder 6-Pin	\$194.00
1193	Large Format Interchangeable Core Cylinder 7-Pin	\$196.00
5109	Security Cylinder 6-Pin	\$425.00
5109	Security Cylinder 7-Pin	\$429.00
U5109	High Security Cylinder 6-Pin	\$569.00
U5109	High Security Cylinder 7-Pin	\$573.00
5193	Security Large Format Interchangeable Core Cylinder 6-Pin	\$526.00
5193	Security Large Format Interchangeable Core Cylinder 7-Pin	\$530.00
K300	ACCENTRA KeyMark® Cylinder 6- or 7-Pin	\$136.00
K840	ACCENTRA KeyMark Large Format Interchangeable Core Cylinder 6-Pin or 7-Pin	\$234.00
K640	ACCENTRA KeyMark Small Format Interchangeable Core Cylinder 6- or 7-Pin	\$228.00
A640	Best® Keyway Small Format Interchangeable Core Cylinder 6- or 7-Pin	\$184.00
2109	Schlage® "C" Keyway Cylinder 6-Pin - 0-bitted or Keyed Random	\$108.00
MORTISE CYLINDERS 350F, 650F, 660F, 670F SERIES TRIM:		
2153	Standard Cylinder 6-Pin	\$108.00
2153	Standard Cylinder 7-Pin	\$110.00
2196	Large Format Interchangeable Core Cylinder 6-Pin	\$194.00
2197	Large Format Interchangeable Core Cylinder 7-Pin	\$196.00
5153	Security Cylinder 6-Pin	\$425.00
5153	Security Cylinder 7-Pin	\$429.00
U5153	High Security Cylinder 6-Pin	\$569.00
U5153	High Security Cylinder 7-Pin	\$573.00
5196	Security Large Format Interchangeable Core Cylinder 6-Pin	\$526.00
5197	Security Large Format Interchangeable Core Cylinder 7-Pin	\$530.00
K100	ACCENTRA KeyMark® Cylinder 6- or 7-Pin	\$126.00
K820	ACCENTRA KeyMark Large Format Interchangeable Core Cylinder 6-Pin or 7-Pin	\$234.00
K620	ACCENTRA KeyMark Small Format Interchangeable Core Cylinder 6-Pin or 7-Pin	\$228.00
A620	Best® Keyway Small Format Interchangeable Core Cylinder 6- or 7-Pin	\$184.00

*Rim cylinders not available in 629 or 630 finishes.

NOTES: Cylinder rings/collars furnished at no charge when ordered with cylinder.
Specify ring/collar size when ordering.
ACCENTRA KeyMark® and Security products are priced separately. The cylinders are not discounted the same as the trim.

When Ordering: Specify finish where required.

1500 SERIES MISCELLANEOUS

MODEL #	PRODUCT DESCRIPTION	ALL FINISHES
STRIKES:		
702	Floor Strike (for bottom Pullman Latch, optional)	\$53.00
712	Strike for overlapping astragal (optional for 1530)	
718	Open Back Strike (optional)	\$234.00
790	Bottom Deadbolt Strike	\$53.00
791	Upper Latch Strike	\$103.00
793	Rim Strike (optional)	\$85.00
794	Bottom Deadbolt Strike (optional)	\$53.00
797	Bracket for Flush Doors (optional)	\$7.00
798	ANSI Universal Strike (for 1530)	\$53.00
799	Rim Strike	\$108.00
202	Strike Box (optional)	\$2.00
MORTISE LOCKS:		
15KF	Mortise Lock Knob or Pull Trim, F01-F02-F03	\$1,096.00
15LF	Mortise Lock Lever Trim, F01-F02-F03	
18KF	Mortise Lock Knob Trim, F08	
18LF	Mortise Lock Lever Trim, F08	
18TF	Mortise Lock Thumbturn Trim, F05	
EXTENSION RODS:		
7010-2	2" Extension	\$110.00
7010-6	6" Extension	\$126.00
7010-12	12" Extension	\$141.00
7010-24	24" Extension	\$167.00

When Ordering: Specify finish where required.

REMOVABLE MULLIONS

MODEL #	PRODUCT DESCRIPTION	600
REMOVABLE MULLIONS:		
M200	Steel Mullion – Panic Rated x 7'2"	\$956.00
M200F	Steel Mullion – 3 Hour Fire Rated x 7'2"	\$1,329.00
M200F	Steel Mullion – 3 Hour Fire Rated x 10'	\$1,352.00
M200SM	Split Mullion - Steel Panic Rated x 8'	\$1,213.00
KEYED REMOVABLE MULLIONS:		
KRM200	Steel Mullion – Panic Rated x 7'2"	\$1,589.00
KRM200F	Steel Mullion – 1-1/2 Hour Fire Rated x 7'2"	\$1,919.00
KRM200F	Steel Mullion – 1-1/2 Hour Fire Rated x 10'	\$1,944.00
KRM200SM	Split Mullion - Steel Panic Rated x 8'	\$1,791.00

NOTES:

Mullion Cylinder Kit not included with KRM Mullions. Must order separately.
Mullions longer than 8' must be ordered as fire rated option x 10' length. Fire rating is valid only up to 96".

MODEL	PRODUCT DESCRIPTION	LIST PRICE
MULLION CYLINDER KITS		
AMCK1	KRM200 - Steel Mullion - Panic Rated x 7'2"	\$108.00
	KRM200F - Steel Mullion - 1-1/2 Hour Fire Rated x 7'2" or 10'	
	KRM200SM - Split Mullion - Steel Panic Rated x 8'	

*Specify Finish and Cylinder Key Code when ordering

Ex: AMCK1 x FINISH x CYLINDER CODE (i.e. AMCK1 x 630 x CT6)

MODEL	PRODUCT DESCRIPTION	CYLINDER LENGTH	COLLAR SIZE	ALL FINISHES
			STD. MULLION	
MORTISE CYLINDERS FOR KRM SERIES: (CYLINDERS ARE NOT INCLUDED WITH MULLIONS, MUST BE ORDERED SEPARATELY)				
2153	Standard Cylinder 6-Pin	1-1/8"	1765.312	\$108.00
2153	Standard Cylinder 7-Pin	1-1/4"	1765.500	\$110.00
2196	Large Format Interchangeable Core Cylinder 6-Pin	1-1/2"	1765.750	\$194.00
2197	Large Format Interchangeable Core Cylinder 7-Pin	1-11/16"	1765.844	\$196.00
5153	Security Cylinder 6-Pin	1-1/8"	1765.312	\$425.00
5153	Security Cylinder 7-Pin	1-1/4"	1765.500	\$429.00
5196	Security Large Format Interchangeable Core Cylinder 6-Pin	1-1/2"	1765.750	\$526.00
5197	Security Large Format Interchangeable Core Cylinder 7-Pin	1-11/16"	1765.844	\$530.00
K100	ACCENTRA KeyMark® Cylinder 6- or 7-Pin	1-1/8"	1765.312	\$126.00
K100	ACCENTRA KeyMark® Cylinder 6- or 7-Pin	1-1/4"	1765.500	
K100	ACCENTRA KeyMark® Cylinder 6- or 7-Pin	1-1/2"	1765.750	\$267.00
K820	ACCENTRA KeyMark® Large Format Interchangeable Core Cylinder 6-Pin	1-1/2"	1765.750	\$234.00
K820	ACCENTRA KeyMark® Large Format Interchangeable Core Cylinder 7-Pin	1-11/16"	1765.844	
K620	ACCENTRA KeyMark® Small Format Interchangeable Core Cylinder 6-Pin	1-1/4"	1765.500	\$228.00
K620	ACCENTRA KeyMark® Small Format Interchangeable Core Cylinder 6- or 7-Pin	1-3-8"	1765.563	
A620	Best® Keyway Small Format Interchangeable Core Cylinder 6-Pin	1-1/4"	1765.500	\$184.00
A620	Best® Keyway Small Format Interchangeable Core Cylinder 6- or 7-Pin	1-3-8"	1765.563	
2553*	Schlage® "C" Keyway Cylinder 6-Pin - 0-bitted or Keyed Random	1-1/8"	1765.312	\$108.00

NOTE: Cylinders ordered separately, not included with KRM mullions

*2553 only available in 606, 612, 613 and 626 finishes.

MODEL/PART #	PRODUCT DESCRIPTION	LIST PRICE
M203	Door Frame Spacer Block	\$71.00
M204	Door Frame Angle Bracket	
60-7000-0750	Locking Mechanism for KRM200(F)	\$685.00
60-7000-0755	Top Retainer Pack for KRM200(F) and KRM200SM x 8'	\$298.00
60-7000-0759	Top Retainer Pack for M200(F) x 7' or 8' and M200SM x 8'	
60-7000-0760	Bottom Retainer Pack for KRM200(F) and KRM200SM x 8'	\$198.00
60-7000-0763	Bottom Retainer Pack for M200(F) x 7' or 8' and M200SM x 8'	
60-7000-0051	Split Mullion Socket Flat Head Screws for M200SM x 8' and KRM200SM x 8'	\$8.00
81-6419-2412-058	#8-32 X 1/2 Mullion Cyl. Set Screw	\$4.00

5800 SERIES CAST IRON DOOR CLOSERS

STANDARD FINISHES: Products will be furnished only in the following finishes.

ANSI/BHMA CODE	FINISH DESCRIPTION
689	Aluminum Painted
690	Dark Bronze Painted
BSP	Black Suede Powder Coat

Adjustable Sizes 1 thru 6

MODEL #	PRODUCT DESCRIPTION	CASE QUANTITY	APPROX. SHIPPING WT. LBS. EACH	LIST PRICE
NON-HOLD OPEN:				
5801	Regular, Parallel, Top Jamb to 3" Reveal	3	12	\$588.00
5801DL	Regular, Parallel, Top Jamb to 3" Reveal with Delayed Action	3	12	\$651.00
5821	Stop Only	3	14	\$671.00
5831	Stop Only with Spring	3	14	\$862.00
HOLD OPEN:				
5811	Regular, Parallel, Top Jamb to 2-3/4" Reveal	3	12	\$637.00
5821T	Holder/Stop Thumbturn	3	14	\$720.00
5831T	Holder/Stop Thumbturn with Spring	3	14	\$911.00

Note: Sleeve Nuts furnished standard with all models. For heavy-duty parallel rigid arm applications, specify 5821 or 5821T, stop is removable.

ACCESSORIES AND PARTS

MODEL #	PRODUCT DESCRIPTION	LIST PRICE
DROP PLATES:		
5800RDP	Narrow Frame Drop Plate (Regular Arm)	\$124.00
5800PDP	Narrow Top Rail Drop Plate (Parallel Arm)	
COVER:		
5800COV	Cover Only	\$41.00
SCREW PACKS:		
5800SP	Screw Pack	\$14.00
SN-134	Sleeve Nuts Only 1-3/4" Door	\$9.70
TBGN134-47	Through-Bolts and Grommet Nuts 1-3/4" Door	\$20.90

*No charge when ordered with closer.

MODEL #	PRODUCT DESCRIPTION	LIST PRICE
2730KIT	Door Saver Spring Stop	\$169.00
293BSS	Blade Stop Spacer	\$31.00

Specify finish.

4400 SERIES INSTITUTIONAL DOOR CLOSERS

FINISHES AND FASTENERS

ANSI/BHMA CODE	FINISH DESCRIPTION
600	Primed for Painting
613E	Dark Oxidized Satin Bronze - equivalent
689	Aluminum Painted
690	Dark Bronze Painted
691	Light Bronze Painted
693	Black Painted
694	Medium Bronze Painted
696	Satin Brass Painted
BSP	Black Suede Powder Coat
WSP	White Suede Powder Coat

ANSI/BHMA CODE	FINISH DESCRIPTION
605^	Bright Brass, Clear Coated
606^	Satin Brass, Clear Coated
611^	Bright Bronze, Clear Coated
612^	Satin Bronze, Clear Coated
625^	Bright Chrome Plated
626^	Satin Chrome Plated

Closer bodies and plastic covers are available in waterborne acrylic finishes; arms and metal covers are available in powder coat or plated finishes.

^ Plated finish; metal cover required

ADDITIONAL FINISHING CHARGES	605, 606, 611, 612, 625, 626
Arm	\$466.00
*Cover - Metal	\$320.00
Drop Plates	\$280.00
Sleeve Nuts	\$44.00
Soffit Plates	\$142.00

*Metal Cover suffix "M" to closer model number. Cost of metal cover included in plating charge.

DOOR CLOSER PAINT (PRICE PER CAN)			
MODEL #	PRODUCT DESCRIPTION	APPROX. SHIPPING WT. LBS.	LIST PRICE
1A	Aluminum Spray Paint (689)	8	\$54.00
2B	Light Bronze Spray Paint (691)	8	
5S	Dark Bronze Spray (STAT) Paint (690)	8	
6SB	Gold Spray Paint (696)	8	

PRODUCT OPTIONS	ADD
SPECIAL FINISHES: • Contact factory for availability • 50 piece minimum order for non-standard sprayed or powder coat finishes Additional charge per item (surface closer, stop/holder, pivot, etc) will be added to net/net charge	Net add \$55.00 per item
6FIN - Sprayed Finish Samples	\$54.00
600 special rust inhibiting prime coat.	\$54.00
LEAD-LINED METAL COVER: (4400M only)	\$271.00
*GROMMET NUTS: Suffix "TBGN" to model number (1-3/8", 1-3/4" doors) Ordered with closer - PKG of 4 each	N/C
*SLEEVE NUTS: Bolts excluded Ordered with closer - Steel base material - PKG of 4 each	\$2.00
Ordered with closer or separately - Stainless Steel - PKG of 4 each (1-3/4" door only)	\$141.00
*SECURITY TORX® HEAD SCREWS: Standard sizes only - each screw (machine screws only - no self-drilling/self-tapping or wood screws available)	\$1.00
TORX® TOOL KIT #20-0040-0868-005 Includes one handle/driver and six bits; T10, T15, T20, T25, T27 and T30 NOTE: Furnished no charge with first 30 closers. Another kit furnished with each additional 50 closers.	\$274.00

*See Page 178 for packages.

Refer to Page 178 for Torx® screw packages.

SERIES 4400, 4400S CLOSERS

4400 SERIES CLOSER - Adjustable Sizes 1 thru 6

(6 per case)

MODEL #	PRODUCT DESCRIPTION	APPROX. SHIPPING WT. LBS.	LIST PRICE
NON-HOLD OPEN:			
4400	Tri-packed (regular, parallel or top jamb to 3" reveal)	13	\$767.00
TJS4400	Top Jamb Only Reveals 0-3" (Handed)	13	
TJ4400	Top Jamb Only Reveals 2-3/4" to 7" (to 150°)	13	
TJL4400	Top Jamb Only Reveals 2-3/4" to 7" (to 180°)	13	
PR4400	Parallel Rigid Arm	13	\$800.00
4480	Regular Low Profile Arm	13	\$767.00
PA4480	Parallel Low Profile Arm	13	
4400ST	Pull Side Slide Track	13	\$860.00
P4400ST	Push Side Slide Track	13	
4440ST	Pull Side Low Profile Slide Track	13	
P4440ST	Push Side Low Profile Slide Track	13	
4420	Stop Only	14	\$858.00
4430	Stop Only with Spring	15	\$1,083.00
^UNI4400	UNI Stop™ Door Control	15	\$1,144.00
*UNIJ4400	Top Jamb UNI Stop™ Door Control	15	\$1,210.00
HOLD OPEN:			
4410	Tri-packed (regular, parallel or top jamb to 3" reveal)	13	\$835.00
TJ4410	Top Jamb Only Reveals 2-3/4" to 6-3/4" (to 150°)	13	
TJL4410	Top Jamb Only Reveals 2-3/4" to 6-3/4" (to 180°)	13	
PR4410	Parallel Rigid Arm (Handed)	13	\$883.00
4410ST	Pull Side Slide Track	13	\$922.00
P4410ST	Push Side Slide Track	13	
4450ST	Pull Side Low Profile Slide Track	13	
P4450ST	Push Side Low Profile Slide Track	13	
4420T	Holder/Stop Thumbturn	14	\$946.00
4430T	Holder/Stop Thumbturn with Spring	15	\$1,170.00
^UNI4410	UNI Stop™ Door Control	15	\$1,280.00
*UNIJ4410	Top Jamb UNI Stop™ Door Control	15	\$1,365.00

*When Ordering Specify Reveal. ^When Ordering Specify Door Width.

NOTE: Sleeve Nuts furnished standard with PR, Holder/Stop, Holder/Stop Spring and UNI Stop™ arms.

OPTIONS		
Delayed Action suffix "DL" to model number	ADD	\$63.00
Double Egress suffix "DE" to Slide Track model number (handed) hinge side only (N/A in Stainless Steel)	ADD	\$118.00
Enhanced Backcheck suffix "EBC" to model number	ADD	\$49.00
Metal Cover suffix "M" to model number (N/A in Stainless Steel)	ADD	\$25.00
ABS Cover suffix "G" to model number	ADD	\$5.00
Offset Soffit Plate prefix "PRO" to model number	ADD	\$39.00
Regular rigid heavy-duty arm prefix "R" to model number TORX® screws not included (N/A in stainless steel). See Page 178 for TORX® screw package.	ADD	\$68.00

4400S SERIES CORROSION RESISTANT CLOSER:

(4 per case)

MODEL #	PRODUCT DESCRIPTION	APPROX. SHIPPING WT. LBS.	LIST PRICE
NON-HOLD OPEN: Not Tri-Packed			
4400S	Regular Arm or Top Jamb to 3" Reveal	14	\$1,602.00
PA4400S	Parallel Arm	14	
TJ4400S	Top Jamb 2-3/4" to 7" Reveal	14	

Stainless Steel Closers not discounted beyond 50%. Excluded from Buying Program.

RETROFIT PLATES FOR 4400 SERIES:

MODEL #	PRODUCT DESCRIPTION	LIST PRICE
RP44-4040	Retrofit Plate for LCN 4040	\$125.00
RP44-4010	Retrofit Plate for LCN 4010	

When Ordering: Specify finish. Specify hand, reveal and door width where noted.

BACK PLATES & DROP PLATES FOR 4400 SERIES CLOSERS

MODEL #	PRODUCT DESCRIPTION	LIST PRICE
486	Narrow Frame Drop Plate	\$130.00
4860H	Overhead Door Holder Drop Plate	
486JP	Slide Track Back Plate	
487	Low Ceiling Clearance Drop Plate	
488	Narrow Top Rail Drop Plate	

MISCELLANEOUS CLOSER ACCESSORIES

MODEL #	PRODUCT DESCRIPTION	LIST PRICE
**6190	UNI Stop™ Soffit Plate Support Bracket	\$76.30
6191	UNI Stop™ Wide Frame Reinforcing Kit	\$95.90
890	Narrow Frame Support Bracket	\$87.70
891	Clearance/Support Blade Stop	

ACCESSORIES FOR 4400 SERIES CLOSERS:

MODEL #	PRODUCT DESCRIPTION	LIST PRICE
*289	Standard Soffit Plate, Non-Hold Open	\$41.00
289A-SS	Stainless Steel Soffit Plate, Non-Hold Open	\$104.00
*588	Standard Soffit Plate, Hold Open	\$41.00
*413A	Soffit Bracket (Mounting Between Doors)	\$70.10
*297	Narrow Frame/Removable Stop Soffit Plate	
*299	Blade/Applied Stop Soffit Plate	
*290	Extra-Clearance Offset Soffit Plate	
*293L	Flush Rabbeted Transom Angle Bracket	\$52.00
*293S	Spacer Block	\$16.10
*589L	Flush Transom Angle Bracket	\$70.10
*291, 291A	Molded/Bull Nose Trim Bracket	
292	Molded/Bull Nose Trim Bracket	
498	Standard Drop Corner Bracket	\$344.00
2498	Extra Drop Mounting Bracket	\$344.00
COVERS:		
400P	4400 Series Plastic Covers - Sprayed	\$58.00
400PG	4400 ABS Plastic Covers - Sprayed	\$67.00
400M	4400 Series Metal Covers - Sprayed	\$86.00
TJ400M	TJ4400 Metal Covers - Sprayed (Handed)	
400MP	4400 Series Metal Covers - Plated	\$406.00
TJ400MP	TJ4400 Metal Covers - Plated (Handed)	

* No charge when ordered with closer.

** Furnished regularly with all Parallel Arm UNI Stop™, no extra. When ordering 6191 in place of 6190, no extra.

When Ordering: Specify finish. Specify hand where noted.

CLOSER BODIES:

MODEL #	PRODUCT DESCRIPTION	LIST PRICE
4400LAP	4400 Door Closer Body	\$600.00
4400SLAP	4400S Corrosion Resistant Door Closer Body	\$1,248.00

OPTIONS		
Delayed Action suffix "DL" to model number	ADD	\$63.00

SCREW PACKS:

MODEL #	PRODUCT DESCRIPTION	LIST PRICE
SN-134	Sleeve Nuts Only 1-3/4" Door	\$9.70*
SN-214	Sleeve Nuts Only 2-1/4" Door	\$109.00
SNB134-47	Sleeve Nuts and Bolts 1-3/4" Door	\$30.00
SNB200-47	Sleeve Nuts and Bolts 2" Door	
SNB214-47	Sleeve Nuts and Bolts 2-1/4" Door	\$151.00
SN-134SS	Stainless Steel Sleeve Nuts Only for 1-3/4" Door	\$144.00
SNB134SS-47	Stainless Steel Sleeve Nuts and Bolts for 1-3/4" Door	\$151.00
TBGN138-47	Through-Bolts & Grommet Nuts 1-3/8" Door	\$22.00
TBGN134-47	Through-Bolts & Grommet Nuts 1-3/4" Door	

NOTE: Sleeve Nuts furnished standard with PR, Holder/Stop, Holder/Stop Spring and UNI Stop™ arms.
*For PLATED steel sleeve nuts or sleeve nuts and bolts add \$44.00 to list price.

TORX® SCREW PACKS:

MODEL #	PRODUCT DESCRIPTION	LIST PRICE
TX47	TORX® Screw Pack, Standard	\$81.00
PRTX47	TORX® Screw Pack, Parallel Rigid, Holder/Stop or Holder/Stop Spring	\$81.00
RTX47	TORX® Screw Pack, Regular Rigid Heavy-Duty Arm	\$81.00
UNITX47	TORX® Screw Pack, UNI Stop™ Arm	\$81.00

When Ordering: Specify finish. Specify door closer size where noted.

ARMS AND ARM ASSEMBLIES (PARTS)

REGULAR, TOP JAMB AND PARALLEL ARMS

MODEL #	PRODUCT DESCRIPTION	LIST PRICE
Y400-1	Regular Arm Assembly Non-Hold Open	\$153.00
400-1M	Main Arm	\$83.00
Y400-111	Secondary Arm Assembly	\$88.00
Y400-1W	Arm Assembly Less Rod & Shoe	\$135.00
Y400-11	Rod & Shoe Assembly	\$59.00
Y400-1A	J Top Jamb Arm Assembly Non-Hold Open	\$153.00
400-1M	Main Arm	\$83.00
Y400-121	Secondary Arm Assembly	\$88.00
Y400-1W	Arm Assembly Less Rod & Shoe	\$135.00
Y400-11A	Rod & Shoe Assembly	\$59.00
Y400-1B	JL Top Jamb Arm Assembly Non-Hold Open	\$153.00
400-2M	Main Arm	\$83.00
Y400-131	Secondary Arm Assembly	\$88.00
Y400-2W	Arm Assembly Less Rod and Soffit Plate	\$135.00
Y400-11B	Rod & Shoe Assembly	\$59.00
Y400-5	Parallel Arm w/ 289 Soffit Plate, Non-Hold Open	\$153.00
400-1M	Main Arm	\$83.00
Y400-115	Secondary Arm Assembly	\$88.00
Y400-1W	Arm Assembly Less Rod & Soffit Plate	\$135.00
Y400-15	Rod & 289 Soffit Plate Assembly	\$59.00
*Y400-5A	Parallel Arm w/ 289 Soffit Plate, Non-Hold Open	\$153.00
400-1M	Main Arm	\$83.00
*Y400-115A	Secondary Arm Assembly	\$88.00
Y400-1W	Arm Assembly Less Rod & Soffit Plate	\$135.00
*Y400-15A	Rod & 289 Soffit Plate Assembly	\$59.00
400-3	Regular Hold Open Arm Assembly	\$221.00
400-1M	Main Arm	\$83.00
400-113	Secondary Arm Assembly	\$138.00
400-3W	Main Arm & Rod Assembly	\$135.00
400-31	Adjusting Rod	\$28.60
400-13	Holder Shoe & Loop Assembly	\$135.00
400-3A	J Top Jamb Hold Open Arm Assembly	\$221.00
400-1M	Main Arm	\$83.00
400-123	Secondary Arm Assembly	\$138.00
400-3WA	Main Arm & Rod Assembly	\$135.00
400-31A	Adjusting Rod	\$28.60
400-13	Holder Shoe & Loop Assembly	\$135.00
400-3B	JL Top Jamb Hold Open Arm Assembly	\$221.00
400-2M	Main Arm	\$83.00
400-133	Secondary Arm Assembly	\$138.00
400-3WB	Main Arm & Rod Assembly	\$135.00
400-31B	Adjusting Rod	\$28.60
400-13	Holder Shoe & Loop Assembly	\$135.00
400-8	Parallel Hold Open Arm Assembly	\$221.00
400-1M	Main Arm	\$83.00
400-118	Secondary Arm Assembly w/ 588 Soffit	\$138.00
400-3W	Main Arm & Rod Assembly	\$135.00
400-13	Holder Shoe & Loop Assembly	\$135.00
400-31B	Adjusting Rod	\$28.60
Y400-25	Regular & Parallel Arm w/ 289A Soffit - Tri-Pkg, Non-Hold Open	\$153.00

*180° door swing using special template for doors hung on 6" to 8" wide throw hinges

When Ordering: Specify finish.

ARMS AND ARM ASSEMBLIES (PARTS)

RIGID ARMS

MODEL #	PRODUCT DESCRIPTION	LIST PRICE
R400-1	Regular Rigid Heavy-Duty Arm Non-Hold Open	\$234.00
PR400-5	Parallel Rigid Arm Non-Hold Open	\$198.00
PR400-8R	Parallel Rigid Arm Hold Open, Right Hand	\$271.00
PR400-8L	Parallel Rigid Arm Hold Open, Left Hand	
PRO400-5	Parallel Rigid Offset Arm, Non-Hold Open	\$238.00
PRO400-8R	Parallel Rigid Offset Arm Hold Open, Right Hand	\$277.00
PRO400-8L	Parallel Rigid Offset Arm Hold Open, Left Hand	

HOLDER/STOP ARMS (4420, 4420T)

MODEL #	PRODUCT DESCRIPTION	LIST PRICE
4020-5	Stop Arm Assembly, Non-Hold Open	\$266.00
4020T-8	Holder/Stop Arm Assembly	\$365.00
4020P	Hole Plug	\$18.00
4020S	Removable Stop	

HOLDER/STOP SPRING ARMS (4430, 4430T)

MODEL #	PRODUCT DESCRIPTION	LIST PRICE
4030-5	Stop with Spring Arm Assembly, Non-Hold Open	\$518.00
4030T-8	Holder/Stop Spring Arm Assembly Hold Open	\$620.00
4020P	Hole Plug	\$18.00
4030KIT	Holder/Stop Spring Kit	\$216.00

When Ordering: Specify finish.

ARMS AND ARM ASSEMBLIES (PARTS)

UNI STOP™ ARMS

MODEL #	PRODUCT DESCRIPTION	LIST PRICE
6100-11	Arm Assembly Non-Hold Open Door Width 28" to 32"	\$591.00
6100-13	Arm Assembly Non-Hold Open Door Width 33" to 41"	
6100-14	Arm Assembly Non-Hold Open Door Width 42" to 48"	
6100-1	Arm Assembly Hold Open Door Width 28" to 32"	\$747.00
6100-3	Arm Assembly Hold Open Door Width 33" to 41"	
6100-4	Arm Assembly Hold Open Door Width 42" to 48"	

TOP JAMB UNI STOP™ ARMS

MODEL #	PRODUCT DESCRIPTION	LIST PRICE
J6100-4	Arm Assembly Non-Hold Open Frame Reveals 2-1/8" to 3-1/4"	\$657.00
J6200-4	Arm Assembly Non-Hold Open Frame Reveals 1/2" to 2"	
J6400-4	Arm Assembly Non-Hold Open Frame Reveals 3-3/8" to 4-1/4"	
J6500-41	Arm Assembly Non-Hold Open Frame Reveals 4-3/8" to 5-3/8"	
J6500-42	Arm Assembly Non-Hold Open Frame Reveals 5-1/2" to 6-3/8"	
J6500-43	Arm Assembly Non-Hold Open Frame Reveals 6-1/2" to 7-3/8"	
J6600-4	Arm Assembly Non-Hold Open Frame Reveals 0" to 3/8"	
J6100-7	Arm Assembly Hold Open Frame Reveals 2-1/8" to 3-1/4"	\$838.00
J6200-7	Arm Assembly Hold Open Frame Reveals 1/2" to 2"	
J6400-7	Arm Assembly Hold Open Frame Reveals 3-3/8" to 4-1/4"	
J6500-71	Arm Assembly Hold Open Frame Reveals 4-3/8" to 5-3/8"	
J6500-72	Arm Assembly Hold Open Frame Reveals 5-1/2" to 6-3/8"	
J6500-73	Arm Assembly Hold Open Frame Reveals 6-1/2" to 7-3/8"	
J6600-7	Arm Assembly Hold Open Frame Reveals 0" to 3/8"	

When Ordering: Specify finish and hand.

STAINLESS STEEL ARMS

MODEL #	PRODUCT DESCRIPTION	LIST PRICE
400S-1	Regular Arm Assembly Non-Hold Open (SS)	\$586.00
400S-1M	Main Arm (SS) Assembly	\$301.00
400S-11	Adjusting Rod and Shoe	\$143.00
400S-111	Secondary Arm Assembly (SS)	\$301.00
400S-1A	J Top Jamb Arm Assembly Non-Hold Open	\$586.00
400S-1M	Main Arm (SS) Assembly	\$301.00
400S-121	Secondary Arm Assembly (SS)	
400S-6	Parallel Arm Assembly Non-Hold Open (SS)	\$586.00
400S-1M	Main Arm (SS) Assembly	\$301.00
400S-16	Adjusting Rod and Soffit Plate	\$143.00
400S-116	Secondary Arm Assembly (SS)	\$301.00
400S-AS	Arm Shoe Assembly	\$80.00
400S-ES	Elbow Screw and Washer Assembly	\$15.20

LOW PROFILE ARMS

MODEL #	PRODUCT DESCRIPTION	LIST PRICE
2400-1	Regular Arm, Low Profile, Non-Hold Open	\$153.00
2400-1MR	Main Arm & Adjusting Rod Assembly	\$135.00
2400-1TS	Tube & Shoe/Soffit Assembly	\$59.00
2400-5	Parallel Arm, Low Profile, Non-Hold Open	\$153.00
2400-1MR	Main Arm & Adjusting Rod Assembly	\$135.00
2400-5TS	Tube & Soffit 289 Assembly	\$59.00
2400-25	Low Profile, Tri-Pkg, Non-Hold Open	\$153.00

LOW PROFILE SLIDE TRACK ASSEMBLIES

MODEL #	PRODUCT DESCRIPTION	LIST PRICE
440ST-1T	Pull Side Slide Track Assy Non-Hold Open	\$294.00
440ST-5T	Push Side Slide Track Assy Non-Hold Open	
440ST-3T	Pull Side Slide Track Assy Hold Open	\$440.00
440ST-8T	Push Side Slide Track Assy Hold Open	
440ST-1A	Arm Assembly	\$161.00
440ST-1AR	Adjusting Rod Assembly	\$85.00
400ST-1AT	Arm Tube Assembly	
440SLD	Slider Assembly Non-Hold Open	\$154.00
440HSLD	Slider Assembly Hold Open	\$213.00

When Ordering: Specify finish.

STANDARD SLIDE TRACK ASSEMBLIES

MODEL #	PRODUCT DESCRIPTION	LIST PRICE
400ST-1T	Pull Side Slide Track Assy Non-Hold Open	\$294.00
400ST-5T	Push Side Slide Track Assy Non-Hold Open	
400ST-1T180	Pull Side Slide Track Assy Non-Hold Open 180°	
400ST-3T	Pull Side Slide Track Assy Hold Open	\$440.00
400ST-8T	Push Side Slide Track Assy Hold Open	
400ST-1A	Arm Assembly (all except STP)	\$161.00
400STP-1A	Arm Assembly (STP only)	
400PT-DE-1R	Double Egress Arm Assembly Right Hand	\$294.00
400PT-DE-1L	Double Egress Arm Assembly Left Hand	
400ST-1ATR	Double Egress Arm Tube Assy Right Hand	\$213.00
400ST-1ATL	Double Egress Arm Tube Assy Left Hand	
400ST-1AT	Arm Tube Assembly (except STP)	\$85.00
400ST-1AR	Adjusting Rod Assembly (all units)	
400STP-1AT	Arm Tube Assembly (STP only)	
400STEC	End Cap Non-Hold Open and Hold Open (2 required)	\$11.30
400SLD	Slider Assembly	\$154.00
400ASR	Retaining Ring	\$5.30
400AS	Arm Stud	\$10.70
400ASC	Arm Stud Clip	\$13.90

MISCELLANEOUS PARTS

MODEL #	PRODUCT DESCRIPTION	LIST PRICE
1543R	Jackscrew (holder loop to bracket) Right Hand	\$20.60
1543L	Jackscrew (holder loop to bracket) Left Hand	
455	Locknut (holder loop to bracket)	\$19.00
1554	Friction Disc (holder loop)	\$11.60
400-AS	Arm Shoe Assembly	\$33.00
400-HS	Hex Screw	\$1.80
400-ES	Elbow Screw & Washer Assembly	\$13.30
400-MAS	Main Arm Screw	\$13.00
400-ALAS	Arm Length Adjusting Screw	\$10.30
400-HSS	Holder Set Screw	\$13.00

When Ordering: Specify finish. Specify ring/collar size when ordering with cylinder.

3000 SERIES ARCHITECTURAL DOOR CLOSERS

FINISHES AND FASTENERS

ANSI/BHMA CODE	FINISH DESCRIPTION
600	Primed for Painting
613E	Dark Oxidized Satin Bronze - equivalent
689	Aluminum Painted
690	Dark Bronze Painted
691	Light Bronze Painted
693	Black Painted
694	Medium Bronze Painted
696	Satin Brass Painted
BSP	Black Suede Powder Coat
WSP	White Suede Powder Coat

ANSI/BHMA CODE	FINISH DESCRIPTION
605^	Bright Brass, Clear Coated
606^	Satin Brass, Clear Coated
611^	Bright Bronze, Clear Coated
612^	Satin Bronze, Clear Coated
625^	Bright Chrome Plated
626^	Satin Chrome Plated

Closer bodies and plastic covers are available in waterborne acrylic finishes; arms and metal covers are available in powder coat or plated finishes.

^ Plated finish; metal cover required. Metal cover is only available with 3501 closer.

ADDITIONAL FINISHING CHARGES	605, 606, 611, 612, 625, 626
Arm	\$466.00
*Cover - Metal	\$320.00
Drop Plates	\$280.00
Sleeve Nuts	\$44.00
Soffit Plates	\$142.00

*Metal Cover suffix "M" to closer model number. ("M" available on 3501 only). Cost of metal cover included in plating charge.

DOOR CLOSER PAINT (PRICE PER CAN)			
MODEL #	PRODUCT DESCRIPTION	APPROX. SHIPPING WT. LBS.	LIST PRICE
1A	Aluminum Spray Paint (689)	8	\$54.00
2B	Light Bronze Spray Paint (691)	8	
5S	Dark Bronze Spray (STAT) Paint (690)	8	
6SB	Gold Spray Paint (696)	8	

PRODUCT OPTIONS	ADD
SPECIAL FINISHES: • Contact factory for availability • 50 piece minimum order for non-standard sprayed or powder coat finishes Additional charge per item (surface closer, stop/holder, pivot, etc) will be added to net/net charge	Net add \$55.00 per item
6FIN - Sprayed Finish Samples	\$54.00
600 special rust inhibiting prime coat.	\$54.00
LEAD-LINED METAL COVER: (3500M series only)	\$271.00
*GROMMET NUTS: Suffix "TBGN" to model number (1-3/8", 1-3/4", 2-1/4" doors) Ordered with closer - PKG of 4 each	N/C
*SLEEVE NUTS: Bolts excluded Ordered with closer - Steel base material - PKG of 4 each	\$2.00
Ordered with closer or separately - Stainless Steel - PKG of 4 each (1-3/4" doors only)	\$141.00
*SECURITY TORX® HEAD SCREWS: Standard sizes only - each screw (machine screws only - no self-drilling/self-tapping or wood screws available)	\$1.00
TORX® TOOL KIT #20-0040-0868-005 Includes one handle/driver and six bits; T10, T15, T20, T25, T27 and T30 NOTE: Furnished no charge with first 30 closers. Another kit furnished with each additional 50 closers.	\$274.00

*See Page 189 for packages.

Refer to Page 189 for Torx® screw packages.

When Ordering: Specify finish.
Specify ring/collar size when ordering with cylinder.

SERIES 3101, 3301 CLOSERS

3101 SERIES WITHOUT COVER - Adjustable Sizes 1 thru 6 (4 per case)

MODEL #	PRODUCT DESCRIPTION	APPROX. SHIPPING WT. LBS.	LIST PRICE
NON-HOLD OPEN:			
3101	Tri-packed (regular, parallel or top jamb to 3" reveal)	8	\$512.00
TJ3101	Top Jamb 2-3/4" to 7" Reveal (to 150°)	8	
PR3101	Parallel Rigid Arm	8	\$545.00
3181	Regular Low Profile Arm	8	\$512.00
PA3181	Parallel Low Profile Arm	8	
HOLD OPEN:			
3111	Tri-packed (regular, parallel or top jamb to 3" reveal)	8	\$580.00
TJ3111	Top Jamb 2-3/4" to 6-3/4" Reveal	8	
PR3111	Parallel Rigid Arm (Handed)	8	\$628.00

3301 SERIES WITH SLIM LINE COVER - Adjustable Sizes 1 thru 6 (4 per case)

MODEL #	PRODUCT DESCRIPTION	APPROX. SHIPPING WT. LBS.	LIST PRICE
NON-HOLD OPEN:			
3301	Tri-packed (regular, parallel or top jamb to 3" reveal)	8	\$555.00
TJ3301	Top Jamb 2-3/4" to 7" Reveal	8	
PR3301	Parallel Rigid Arm	8	\$588.00
3381	Regular Low Profile Arm	8	\$555.00
PA3381	Parallel Low Profile Arm	8	
3321	Stop Only	9	\$646.00
3331	Stop Only with Spring	10	\$871.00
^UNI3301	UNI Stop™ Door Control	10	\$932.00
*UNIJ3301	Top Jamb UNI Stop™ Door Control	10	\$998.00
HOLD OPEN:			
3311	Tri-packed (regular, parallel or top jamb to 3" reveal)	8	\$623.00
TJ3311	Top Jamb 2-3/4" to 6-3/4" Reveal	8	
PR3311	Parallel Rigid Arm (Handed)	8	\$671.00
3321T	Holder/Stop Thumbturn	9	\$734.00
3331T	Holder/Stop Thumbturn with Spring	10	\$958.00
^UNI3311	UNI Stop™ Door Control	10	\$1,068.00
*UNIJ3311	Top Jamb UNI Stop™ Door Control	10	\$1,153.00

*When Ordering Specify Reveal.

^When Ordering Specify Door Width.

NOTE: Sleeve Nuts furnished standard with PR, Holder/Stop, and Holder/Stop Spring UNI Stop™ arms.

OPTIONS		
Delayed Action suffix "DL" to model number	ADD	\$63.00
Offset Soffit Plate prefix "PRO" to model number	ADD	\$39.00

When Ordering: Specify finish and size.
Specify hand, reveal and door width where noted.

SERIES 3501 CLOSERS

3501 SERIES WITH FULL COVER - Adjustable Sizes 1 thru 6

(4 per case)

MODEL #	PRODUCT DESCRIPTION	APPROX. SHIPPING WT. LBS.	LIST PRICE
NON-HOLD OPEN:			
3501	Tri-packed (regular, parallel or top jamb to 3" reveal)	8	\$561.00
TJ3501	Top Jamb 2-3/4" to 7" Reveal	8	
PR3501	Parallel Rigid Arm	8	\$594.00
3581	Regular Low Profile Arm	8	\$561.00
PA3581	Parallel Low Profile Arm	8	
3521	Stop Only	14	\$652.00
3531	Stop Only with Spring	9	\$877.00
^UNI3501	UNI Stop™ Door Control	9	\$938.00
*UNIJ3501	Top Jamb UNI Stop™ Door Control	9	\$1,004.00
HOLD OPEN:			
3511	Tri-packed (regular, parallel or top jamb to 3" reveal)	8	\$629.00
TJ3511	Top Jamb 2-3/4" to 6-3/4" Reveal	8	
PR3511	Parallel Rigid Arm (Handed)	8	\$677.00
3521T	Holder/Stop Thumbturn	14	\$740.00
3531T	Holder/Stop Thumbturn with Spring	9	\$964.00
^UNI3511	UNI Stop™ Door Control	9	\$1,074.00
*UNIJ3511	Top Jamb UNI Stop™ Door Control	9	\$1,159.00

*When Ordering Specify Reveal.

^When Ordering Specify Door Width.

NOTE: Sleeve Nuts furnished standard with PR, Holder/Stop, Holder/Stop Spring and UNI Stop™ arms.

OPTIONS		
Delayed Action suffix "DL" to model number	ADD	\$63.00
Plastic Architectural Cover suffix "A" to model number (sprayed only)	ADD	\$5.00
Metal Cover suffix "M" to model number	ADD	\$10.00
ABS Plastic Cover suffix "G" to model number	ADD	\$5.00
Metal Architectural Cover suffix "MA" to model number (sprayed or plated finishes)	ADD	\$10.00
Offset Soffit Plate prefix "PRO" to model number	ADD	\$39.00
Regular rigid heavy-duty arm prefix "R" to model number TORX® screws not included (N/A in stainless steel). See Page 189 for TORX® screw package.	ADD	\$68.00

When Ordering: Specify finish and size.
Specify hand, reveal and door width where noted.

BACK PLATES & DROP PLATES

MODEL #	PRODUCT DESCRIPTION	LIST PRICE
3146	Narrow Top Rail/Concealed Door Holder Drop Plate	\$76.00
3148	Low Ceiling Clearance Drop Plate	
3158	Exposed-Back/Narrow Top Rail Drop Plate	
3445	Molded Full Cover Decorative Back Plate	
3446	Exposed-Back Drop Plate Kit	\$152.00
3545	Exposed-Back Back Plate	\$76.00
3545A		\$90.00
3546	Concealed Door Holder Drop Plate	\$76.00
3546A		\$143.00
3547	Low Ceiling Clearance/Overhead Door Holder Drop Plate	\$90.00
3547A		
3548		
3548A	Exposed-Back/Narrow Top Rail Drop Plate	\$152.00
3549		
3549A	Exposed-Back/Narrow Top Rail Drop Plate Kit	\$166.00

MISCELLANEOUS CLOSER ACCESSORIES

MODEL #	PRODUCT DESCRIPTION	LIST PRICE
**6190	UNI Stop™ Soffit Plate Support Bracket	\$76.30
6191	UNI Stop™ Wide Frame Reinforcing Kit	\$95.90
890	Narrow Frame Support Bracket	\$87.70
891	Clearance/Support Blade Stop Spacer Block	

ACCESSORIES

MODEL #	PRODUCT DESCRIPTION	LIST PRICE
BRACKETS:		
*289A	Standard Soffit Plate Non-Hold Open	\$41.00
*588	Standard Soffit Plate Hold Open	
*413A	Soffit Bracket (Mounting Between Doors)	\$70.10
*297	Narrow Frame/Removable Stop Soffit Plate	
*299	Blade/Applied Stop Soffit Plate	
*290	Extra-Clearance Offset Soffit Plate	
*293L	Flush Rabbeted Transom Angle Bracket	\$52.00
*293S	Spacer Block	\$16.10
*589L	Flush Transom Angle Bracket	\$70.10
*291	Molded/Bull Nose Trim Bracket	
*291A		
292		
COVERS:		
3200P	Plastic Slim Line Cover	\$43.00
3400P	Plastic Full Cover	\$49.00
3400A	Optional Plastic Architectural Cover	
3400PG	ABS Plastic Full Cover	\$57.00
3400M	Metal Cover	\$60.00
3400M	When Ordered with Closer in Place of 3400P	\$11.00
3400MA	Optional Metal Architectural Cover	\$60.00
3400MA	When Ordered with Closer in Place of 3400P	\$11.00

*No charge when ordered with closer.

** Furnished regularly with all Parallel Arm UNI Stop™ no extra. When ordering 6191 in place of 6190, no extra.

When Ordering: Specify finish.

CLOSER BODIES AND SCREW PACKAGES

CLOSER BODIES:

MODEL #	PRODUCT DESCRIPTION	LIST PRICE
3101LAP	3301 Door Closer Body	\$422.00
3101LAP	3501 Door Closer Body	

OPTIONS		
Delayed Action suffix "DL" to model number	ADD	\$63.00

SCREW PACKS:

MODEL #	PRODUCT DESCRIPTION	LIST PRICE
SN-134	Sleeve Nuts Only 1-3/4" Door	\$9.70*
SN-214	Sleeve Nuts Only 2-1/4" Door	\$109.00
SNB134-38	Sleeve Nuts and Bolts 1-3/4" Door	\$30.00
SNB200-38	Sleeve Nuts and Bolts 2" Door	
SNB214-38	Sleeve Nuts and Bolts 2-1/4" Door	\$151.00
SN-134SS	Stainless Steel Sleeve Nuts Only for 1-3/4" Door	\$144.00
SNB134SS-38	Stainless Steel Sleeve Nuts and Bolts for 1-3/4" Door	\$151.00
TBGN138-38	Through-Bolts & Grommet Nuts 1-3/8" Door	\$22.00
TBGN134-38	Through-Bolts & Grommet Nuts 1-3/4" Door	
TBGN214-38	Through-Bolts & Grommet Nuts 2-1/4" Door	

NOTE: Sleeve Nuts furnished standard with PR, Holder/Stop, Holder/Stop Spring and UNI Stop™ arms.
*For PLATED steel sleeve nuts or sleeve nuts and bolts add \$44.00 to list price.

TORX® SCREW PACKS:

MODEL #	PRODUCT DESCRIPTION	LIST PRICE
TX38	TORX® Screw Pack - Standard	\$81.00
PRTX38	TORX® Screw Pack - Parallel Rigid, Holder/Stop or Holder/Stop Spring	\$81.00
UNITX38	TORX® Screw Pack - UNI Stop™ Arm	\$81.00

When Ordering: Specify finish.
Specify door closer size where noted.

REGULAR, TOP JAMB AND PARALLEL ARMS

MODEL #	PRODUCT DESCRIPTION	LIST PRICE
Y400-1	Regular Arm Assembly Non-Hold Open	\$153.00
400-1M	Main Arm	\$83.00
Y400-111	Secondary Arm Assembly	\$88.00
Y400-1W	Arm Assembly Less Rod & Shoe	\$135.00
Y400-11	Rod & Shoe Assembly	\$59.00
Y400-1A	J Top Jamb Arm Assembly Non-Hold Open	\$153.00
400-1M	Main Arm	\$83.00
Y400-121	Secondary Arm Assembly	\$88.00
Y400-1W	Arm Assembly Less Rod & Shoe	\$135.00
Y400-11A	Rod & Shoe Assembly	\$59.00
Y400-6	Parallel Arm w/ 289A Soffit Plate, Non-Hold Open	\$153.00
400-1M	Main Arm	\$83.00
Y400-116	Secondary Arm Assembly	\$88.00
Y400-1W	Arm Assembly Less Rod & Soffit Plate	\$135.00
Y400-16	Rod & Shoe Assembly	\$59.00
400-3	Regular Hold Open Arm Assembly	\$221.00
400-1M	Main Arm	\$83.00
400-113	Secondary Arm Assembly	\$138.00
400-3W	Main Arm & Rod Assembly	\$135.00
400-31	Adjusting Rod	\$28.60
400-13	Holder Shoe & Loop Assembly	\$135.00
400-3A	J Top Jamb Hold Open Arm Assembly	\$221.00
400-1M	Main Arm	\$83.00
400-123	Secondary Arm Assembly	\$138.00
400-3WA	Main Arm & Rod Assembly	\$135.00
400-31A	Adjusting Rod	\$28.60
400-13	Holder Shoe and Loop Assembly	\$135.00
Y400-6A	Parallel Arm w/ 289A Soffit Plate, Non-Hold Open	\$153.00
400-1M	Main Arm	\$83.00
*Y400-116A	Secondary Arm Assembly	\$88.00
Y400-1W	Arm Assembly Less Rod & Soffit Plate	\$135.00
*Y400-16A	Rod & Shoe Assembly	\$59.00
400-8	Parallel Hold Open Arm Assembly	\$221.00
400-1M	Main Arm	\$83.00
400-118	Secondary Arm Assembly w/588 Soffit	\$138.00
400-3W	Main Arm & Rod Less Holder Shoe Assembly	\$135.00
400-18	Holder Shoe & Loop Assembly	\$135.00
400-31	Adjusting Rod	\$28.60
Y400-26	Regular & Parallel Arm w/ 289A Soffit, Tri-Pkg, Non-Hold Open	\$153.00

*180° door swing using special template for doors hung on 6" to 8" wide throw hinges

When Ordering: Specify finish.

ARMS AND ARM ASSEMBLIES (PARTS)

RIGID ARMS

MODEL #	PRODUCT DESCRIPTION	LIST PRICE
PR400-5	Parallel Rigid Arm Non-Hold Open	\$198.00
PR400-8R	Parallel Rigid Arm Hold Open, Right Hand	\$271.00
PR400-8L	Parallel Rigid Arm Hold Open, Left Hand	

HOLDER/STOP ARMS (3321, 3321T, 3521, 3521T)

MODEL #	PRODUCT DESCRIPTION	LIST PRICE
4020-5	Stop Arm Assembly, Non-Hold Open	\$266.00
4020T-8	Holder/Stop Arm Assembly, Hold Open	\$365.00
4020P	Hole Plug	\$18.00
4020S	Removable Stop	

HOLDER/STOP SPRING ARMS (3331, 3331T, 3531, 3531T)

MODEL #	PRODUCT DESCRIPTION	LIST PRICE
4030-5	Stop w/ Spring Arm Assembly, Non-Hold Open	\$518.00
4030T-8	Holder/Stop w/ Spring Assembly, Hold Open	\$620.00
4020P	Hole Plug	\$18.00
4030KIT	Holder/Stop Spring Kit	\$216.00

UNI STOP™ ARMS

MODEL #	PRODUCT DESCRIPTION	LIST PRICE
6100-11	Arm Assembly Non-Hold Open Door Width 28" to 32"	\$591.00
6100-13	Arm Assembly Non-Hold Open Door Width 33" to 41"	
6100-14	Arm Assembly Non-Hold Open Door Width 42" to 48"	
6100-1	Arm Assembly Hold Open Door Width 28" to 32"	\$747.00
6100-3	Arm Assembly Hold Open Door Width 33" to 41"	
6100-4	Arm Assembly Hold Open Door Width 42" to 48"	

When Ordering: Specify finish.

ARMS AND ARM ASSEMBLIES (PARTS)

TOP JAMB UNI STOP™ ARMS

MODEL #	PRODUCT DESCRIPTION	LIST PRICE
J6100-4	Arm Assembly Non-Hold Open Frame Reveals 2-1/8" to 3-1/4"	\$657.00
J6200-4	Arm Assembly Non-Hold Open Frame Reveals 1/2" to 2"	
J6400-4	Arm Assembly Non-Hold Open Frame Reveals 3-3/8" to 4-1/4"	
J6500-41	Arm Assembly Non-Hold Open Frame Reveals 4-3/8" to 5-3/8"	
J6500-42	Arm Assembly Non-Hold Open Frame Reveals 5-1/2" to 6-3/8"	
J6500-43	Arm Assembly Non-Hold Open Frame Reveals 6-1/2" to 7-3/8"	
J6600-4	Arm Assembly Non-Hold Open Frame Reveals 0" to 3/8"	
J6100-7	Arm Assembly Hold Open Frame Reveals 2-1/8" to 3-1/4"	\$838.00
J6200-7	Arm Assembly Hold Open Frame Reveals 1/2" to 2"	
J6400-7	Arm Assembly Hold Open Frame Reveals 3-3/8" to 4-1/4"	
J6500-71	Arm Assembly Hold Open Frame Reveals 4-3/8" to 5-3/8"	
J6500-72	Arm Assembly Hold Open Frame Reveals 5-1/2" to 6-3/8"	
J6500-73	Arm Assembly Hold Open Frame Reveals 6-1/2" to 7-3/8"	
J6600-7	Arm Assembly Hold Open Frame Reveals 0" to 3/8"	

LOW PROFILE ARMS (3381, 3581)

MODEL #	PRODUCT DESCRIPTION	LIST PRICE
2400-1	Regular Arm, Low Profile, Non-Hold Open	\$153.00
2400-1MR	Main Arm & Adjusting Rod Assembly	\$135.00
2400-1TS	Tube & Shoe/Soffit Assembly	\$59.00
2400-6	Parallel Arm, Low Profile, Non-Hold Open	\$153.00
2400-1MR	Main Arm & Adjusting Rod Assembly	\$135.00
2400-6TS	Tube and Soffit 289A Assembly	\$59.00
2400-26	Low Profile, Tri-Pkg, Non-Hold Open	\$153.00

MISCELLANEOUS

MODEL #	PRODUCT DESCRIPTION	LIST PRICE
1543R	Jackscrew (holder loop to bracket) Right Hand	\$20.60
1543L	Jackscrew (holder loop to bracket) Left Hand	
455	Locknut (holder loop to bracket)	\$19.00
1554	Friction Disc (holder loop)	\$11.60
400-AS	Arm Shoe Assembly	\$33.00
400-ES	Elbow Screw and Washer Assembly	\$13.30
400-HS	Hex Screw	\$1.80
400-HSS	Holder Set Screw	\$13.00
1639	Pinion Cap	\$8.00

When Ordering: Specify finish and hand.

2700 SERIES ARCHITECTURAL DOOR CLOSERS

STANDARD FINISHES: Products will be furnished only in the following finishes.

ANSI/BHMA CODE	FINISH DESCRIPTION
689	Aluminum Painted
690	Dark Bronze Painted
BSP	Black Suede Powder Coat

Adjustable Sizes 1 thru 6

MODEL #	PRODUCT DESCRIPTION	CASE QUANTITY	APPROX. SHIPPING WT. LBS. EACH	LIST PRICE
NON-HOLD OPEN:				
2701	Regular, Parallel, Top Jamb to 3" Reveal	6	6.5	\$335.00
2701DL	Regular, Parallel, Top Jamb to 3" Reveal with Delayed Action	6	6.5	\$397.00
2721	Stop Only	4	7.75	\$477.00
2731	Stop Only with Spring	4	7.75	\$520.00
HOLD OPEN:				
2711	Regular, Parallel, Top Jamb to 2-3/4" Reveal	4	6.5	\$402.00
2721T	Holder/Stop Thumbturn	4	7.75	\$520.00
2731T	Holder/Stop Thumbturn with Spring	4	7.75	\$621.00

Note: Sleeve Nuts furnished standard with all models. For heavy-duty parallel rigid arm applications, specify 2721 or 2721T, stop is removable.

ACCESSORIES AND PARTS

MODEL #	PRODUCT DESCRIPTION	LIST PRICE
DROP PLATES:		
3148	Low Ceiling Clearance Drop Plate	\$76.00
3158	Exposed-Back/Narrow Top Rail Drop Plate	
BRACKETS:		
*293L	Flush Rabbeted Transom Angle Bracket	\$52.00
COVER:		
2700COV	Cover Only	\$42.00
SCREW PACKS:		
2700SP	Screw Pack	\$17.00
SN-134	Sleeve Nuts Only 1-3/4" Door	\$9.70
TBGN134-38	Through-Bolts and Grommet Nuts 1-3/4" Door	\$22.00

*No charge when ordered with closer.

MODEL #	PRODUCT DESCRIPTION	LIST PRICE
2730KIT	Door Saver Spring Stop	\$169.00

Specify finish.

51 SERIES INDUSTRIAL DOOR CLOSERS

FINISHES AND FASTENERS

ANSI/BHMA CODE	FINISH DESCRIPTION
600	Primed for Painting
613E ¹	Dark Oxidized Satin Bronze - equivalent
689	Aluminum Painted
690	Dark Bronze Painted
691	Light Bronze Painted
693	Black Painted
694	Medium Bronze Painted
696	Satin Brass Painted
BSP	Black Suede Powder
WSP	White Suede Powder

ANSI/BHMA CODE	FINISH DESCRIPTION
605 ¹	Bright Brass, Clear Coated
606 ¹	Satin Brass, Clear Coated
611 ¹	Bright Bronze, Clear Coated
612 ¹	Satin Bronze, Clear Coated
625 ¹	Bright Chrome Plated
626 ¹	Satin Chrome Plated

1. Available on arms only

ADDITIONAL FINISHING CHARGES	605, 606, 611, 612, 625, 626
Arm	\$466.00

DOOR CLOSER PAINT (PRICE PER CAN)			
MODEL #	PRODUCT DESCRIPTION	APPROX. SHIPPING WT. LBS.	LIST PRICE
1A	Aluminum Spray Paint (689)	8	\$54.00
2B	Light Bronze Spray Paint (691)	8	
5S	Dark Bronze Spray (STAT) Paint (690)	8	
6SB	Gold Spray Paint (696)	8	

PRODUCT OPTIONS	ADD
SPECIAL FINISHES: <ul style="list-style-type: none"> Contact factory for availability 50 piece minimum order for non-standard sprayed or powder coat finishes Additional charge per item (surface closer, stop/holder, pivot, etc) will be added to net/net charge	Net add \$55.00 per item
6FIN - Sprayed Finish Samples	\$54.00
600 special rust inhibiting prime coat.	\$54.00
*GROMMET NUTS: Suffix "TBGN" to model number (1-3/8", 1-3/4", 2-1/4" doors)	
Ordered with closer - PKG of 4 each	N/C
*SLEEVE NUTS: Bolts excluded	
Ordered with closer - Steel base material - PKG of 4 each	\$2.00
*SECURITY TORX® HEAD SCREWS: Standard sizes only - each screw (machine screws only - no self-drilling/self-tapping or wood screws available)	\$1.00
TORX® TOOL KIT #20-0040-0868-005 Includes one handle/driver and six bits; T10, T15, T20, T25, T27 and T30 NOTE: Furnished no charge with first 30 closers. Another kit furnished with each additional 50 closers.	\$274.00

*See Page 198 for packages.

Refer to Page 198 for Torx® screw package.

SERIES 51 CLOSERS

51 SERIES CLOSER - Adjustable Sizes 1 thru 6

(6 per case)

MODEL #	PRODUCT DESCRIPTION	APPROX. SHIPPING WT. LBS.	LIST PRICE
NON-HOLD OPEN:			
51	Regular, Parallel, Top Jamb to 3" Reveal	8	\$354.00
TJ51	Top Jamb Only Reveals 2-3/4" to 7"	8	
HOLD OPEN:			
151	Regular, Parallel, Top Jamb to 3" Reveal	9	\$422.00
TJ151	Top Jamb Only Reveals 2-3/4" to 6-3/4"	9	

OPTIONS		
Cover suffix "P" to model number	ADD	\$43.00

When Ordering: Specify finish.
Specify size, hand, reveal and door width where noted.

ACCESSORIES FOR SERIES 51 CLOSERS

BACK PLATES & DROP PLATES

MODEL #	PRODUCT DESCRIPTION	LIST PRICE
214	Overhead Door Holder Drop Plate	\$62.00
214C	Narrow Top Rail Drop Plate	
599	Retrofit Adaptor Plate	\$78.00
587	Low Ceiling Clearance/Overhead Holder Drop Plate	\$62.00

ACCESSORIES

MODEL #	PRODUCT DESCRIPTION	LIST PRICE
*289A	Standard Soffit Plate Non-Hold Open	\$41.00
*588	Standard Soffit Plate, Hold Open	
2350	Universal Corner Bracket	\$203.00
294	Retrofit Adaptor Plate	\$70.10
*413A	Soffit Bracket (Mounting Between Doors)	
*297, 299	Narrow Frame/Removable Stop Soffit Plate	
*290	Extra-Clearance Offset Soffit Plate	
*589L	Flush Transom Angle Bracket	
*291, 291A	Molded/Bull Nose Trim Bracket	\$70.10
292		
50P	Plastic Cover	\$61.00
1639	Pinion Cap	\$8.00

*No charge when ordered with closer.

When Ordering: Specify finish. Specify size of closers.

CLOSER BODIES AND SCREW PACKAGES

CLOSER BODIES

MODEL #	PRODUCT DESCRIPTION	LIST PRICE
51LAP	51 Door Closer Body	\$272.00

SCREW PACKS

MODEL #	PRODUCT DESCRIPTION	LIST PRICE
SN-134	Sleeve Nuts Only 1-3/4" Door	\$9.70*
SN-214	Sleeve Nuts Only 2-1/4" Door	\$109.00
SNB134-38	Sleeve Nuts and Bolts 1-3/4" Door	\$30.00
SNB200-38	Sleeve Nuts and Bolts 2" Door	
SNB214-38	Sleeve Nuts and Bolts 2-1/4" Door	\$151.00
SN-134SS	Stainless Steel Sleeve Nuts Only for 1-3/4" Door	\$144.00
TBGN138-38	Through-Bolts & Grommet Nuts 1-3/8" Door	\$22.00
TBGN134-38	Through-Bolts & Grommet Nuts 1-3/4" Door	
TBGN214-38	Through-Bolts & Grommet Nuts 2-1/4" Door	

*For PLATED steel sleeve nuts add \$44.00 to list price.

TORX® SCREW PACKS

MODEL #	PRODUCT DESCRIPTION	LIST PRICE
TX38	TORX® Screw Pack - Standard	\$81.00

When Ordering: Specify finish.
Specify door closer size where noted.

ARMS AND ARM ASSEMBLIES (PARTS)

REGULAR, TOP JAMB AND PARALLEL ARMS

MODEL #	PRODUCT DESCRIPTION	LIST PRICE
Y400-1	Regular Arm Assembly Non-Hold Open	\$153.00
400-1M	Main Arm	\$83.00
Y400-111	Secondary Arm Assembly	\$88.00
Y400-1W	Arm Assembly Less Rod & Shoe	\$135.00
Y400-11	Rod & Shoe Assembly	\$59.00
Y400-1A	J Top Jamb Arm Assembly Non-Hold Open	\$153.00
400-1M	Main Arm	\$83.00
Y400-121	Secondary Arm Assembly	\$88.00
Y400-1W	Arm Assembly Less Rod & Shoe	\$135.00
Y400-11A	Rod & Shoe Assembly	\$59.00
Y400-1B	JL Top Jamb Arm Assembly Non-Hold Open	\$153.00
400-2M	Main Arm	\$83.00
Y400-131	Secondary Arm Assembly	\$88.00
Y400-2W	Arm Assembly Less Rod and Soffit Plate	\$135.00
Y400-11B	Rod & Shoe Assembly	\$59.00
Y400-6	Parallel Arm w/ 289A Soffit Plate, Non-Hold Open	\$153.00
400-1M	Main Arm	\$83.00
Y400-116	Secondary Arm Assembly	\$88.00
Y400-1W	Arm Assembly Less Rod & Soffit Plate	\$135.00
Y400-16	Rod & 289A Soffit Plate Assembly	\$59.00
400-3	Regular Hold Open Arm Assembly	\$221.00
400-1M	Main Arm	\$83.00
400-113	Secondary Arm Assembly	\$138.00
400-3W	Main Arm & Rod Assembly	\$135.00
400-31	Adjusting Rod	\$28.60
400-13	Holder Shoe & Loop Assembly	\$135.00
400-3A	J Top Jamb Hold Open Arm Assembly	\$221.00
400-1M	Main Arm	\$83.00
400-123	Secondary Arm Assembly	\$138.00
400-3WA	Main Arm & Rod Assembly	\$135.00
400-31A	Adjusting Rod	\$28.60
400-13	Holder Shoe & Loop Assembly	\$135.00
400-3B	JL Top Jamb Hold Open Arm Assembly	\$221.00
400-2M	Main Arm	\$83.00
400-133	Secondary Arm Assembly	\$138.00
400-3WB	Main Arm & Rod Assembly	\$135.00
400-31B	Adjusting Rod	\$28.60
400-13	Holder Shoe & Loop Assembly	\$135.00
Y400-6A	Parallel Arm w/ 289A Soffit Plate, Non-Hold Open	\$153.00
400-1M	Main Arm	\$83.00
*Y400-116A	Secondary Arm Assembly	\$88.00
Y400-1W	Arm Assembly Less Rod & Soffit Plate	\$135.00
*Y400-16A	Rod & 289A Soffit Plate Assembly	\$59.00
400-8	Parallel Hold Open Arm Assembly	\$221.00
400-1M	Main Arm	\$83.00
400-118	Secondary Arm Assembly w/588 Soffit	\$138.00
400-3W	Main Arm & Rod Assembly	\$135.00
400-18	Holder Shoe & Loop Assembly w/ 588 Soffit	\$135.00
400-31	Adjusting Rod	\$28.60
Y400-26	Regular & Parallel Arm w/ 289A Soffit - Tri-Pkg, Non-Hold Open	\$153.00

*180° door swing using special template for doors hung on 6" to 8" wide throw hinges

MISCELLANEOUS

MODEL #	PRODUCT DESCRIPTION	LIST PRICE
400-AS	Arm Shoe Assembly	\$33.00
400-ES	Elbow Screw and Washer Assembly	\$13.30
400-HS	Hex Screw	\$1.80

When Ordering: Specify finish.

1100 SERIES INDUSTRIAL DOOR CLOSERS

Products will be furnished only in the following finishes.

ANSI/BHMA CODE	FINISH DESCRIPTION
689	Aluminum Painted
690	Dark Bronze Painted
BSP	Black Suede Powder Coat

MODEL #	PRODUCT DESCRIPTION	CASE QUANTITY	APPROX. SHIPPING WT. LBS.	689 690 BSP
1101BF	Multi-sized Closer - Non-Hold Open	6	6	\$277.00
1101BFCOV	Multi-sized Closer - Non-Hold Open with Cover	6	6	\$305.00
1104BC	Size 4 Closer with Backcheck - Non-Hold Open	6	6	\$259.00
1111BF	Multi-sized Closer - Hold Open	4	8	\$344.00

Note: Sleeve Nuts furnished standard with all models.

MISCELLANEOUS

MODEL #	PRODUCT DESCRIPTION	689 690
1100COV	Cover Only	\$28.00

1900 SERIES TRADITIONAL DOOR CLOSERS

FINISHES AND FASTENERS

ANSI/BHMA CODE	FINISH DESCRIPTION
STANDARD FINISHES:	
600	Primed for Painting
689	Aluminum Painted
690	Dark Bronze Painted
691	Light Bronze Painted
693	Black Painted
694	Medium Bronze Painted
696	Satin Brass Painted

DOOR CLOSER PAINT (PRICE PER CAN)			
MODEL #	PRODUCT DESCRIPTION	APPROX. SHIPPING WT. LBS.	LIST PRICE
1A	Aluminum Spray Paint (689)	8	\$54.00
2B	Light Bronze Spray Paint (691)	8	
5S	Dark Bronze Spray (STAT) Paint (690)	8	
6SB	Gold Spray Paint (696)	8	

PRODUCT OPTIONS	ADD
SPECIAL FINISHES: <ul style="list-style-type: none"> Contact factory for availability 50 piece minimum order for non-standard sprayed or powder coat finishes Additional charge per item (surface closer, stop/holder, pivot, etc) will be added to net/net charge	Net add \$55.00 per item
6FIN - Sprayed Finish Samples	\$54.00
600 special rust inhibiting prime coat.	\$54.00
*GROMMET NUTS: Suffix "TBGN" to model number (1-3/8", 1-3/4", 2-1/4" doors)	
Ordered with closer - PKG of 4 each	N/C
*SLEEVE NUTS: Bolts excluded	
Ordered with closer - Steel base material - PKG of 4 each	\$2.00

*See page 204 for packages.

SERIES 1900 TRADITIONAL SURFACE CLOSERS

1900 SERIES TRADITIONAL CLOSERS

(4 per case)

MODEL #	PRODUCT DESCRIPTION	APPROX. SHIPPING WT. LBS.	LIST PRICE
NON-HOLD OPEN:			
1902/4	Regular Arm	10	\$2,005.00
1905/6	Regular Arm	10	
PA1902/4	Parallel Arm	10	
PA1905/6	Parallel Arm	10	
1902/4DL*	Delayed Action Regular Arm Only	10	\$2,068.00
1905/6DL*	Delayed Action Regular Arm Only	10	
PR1902/4	Parallel Rigid Arm (SN included)	10	\$2,038.00
PR1905/6	Parallel Rigid Arm (SN included)	10	
^UNI1902/4	UNI Stop™ Door Control	13	\$2,382.00
^UNI1905/6	UNI Stop™ Door Control	13	
HOLD OPEN:			
PR1912/4	Parallel Rigid Arm (SN included)	11	\$2,121.00
PR1915/6	Parallel Rigid Arm (SN included)	11	
^UNI1912/4	UNI Stop™ Door Control	13	\$2,518.00
^UNI1915/6	UNI Stop™ Door Control	13	

*When Ordering Specify Door Width.

*Specify hand when ordering.

BACK PLATES & DROP PLATES FOR 1900 SERIES CLOSERS

MODEL #	PRODUCT DESCRIPTION	LIST PRICE
1988	Narrow Top Rail Drop Plate	\$186.00

MISCELLANEOUS CLOSER ACCESSORIES

MODEL #	PRODUCT DESCRIPTION	LIST PRICE
**6190	UNI Stop™ Soffit Plate Support Bracket	\$76.30
6191	UNI Stop™ Wide Frame Reinforcing Kit	\$95.90
890	Narrow Frame Support Bracket	\$87.70
891	Clearance/Support Blade Stop	

ACCESSORIES

MODEL #	PRODUCT DESCRIPTION	LIST PRICE
1950	Corner Bracket	\$294.00
2950	Corner Bracket, Extra Drop	
964	Adjustable Bracket (Arched or Circular Top Door)	
974	Offset Adjustable Bracket (Arched or Circular Top Door)	\$427.00
*289	Soffit Plate Non-Hold Open	\$41.00
*413A	Soffit Bracket (Mounting Between Doors)	\$70.10
*297	Narrow Frame/Removable Stop Soffit Plate	
*299	Blade/Applied Stop Soffit Plate	
*290	Extra-Clearance Offset Soffit Plate	
292	Molded/Bull Nose Trim Bracket	
*293L	Flush Transom Angle Bracket	\$52.00
293S	Spacer Block	\$16.10
*589L	Flush Transom Angle Bracket	\$70.10
*291, 291A	Molded/Bull Nose Trim Bracket	
1983	Retrofit Adaptor Plate	\$161.00
1986	Retrofit Adaptor Plate	

*No charge when ordered with closer.

**Furnished standard with all Parallel Arm UNI Stop™ no extra.

When ordering 6191 in place of 6190, no extra.

When Ordering: Specify finish and hand.

ARMS AND ARM ASSEMBLIES (PARTS)

REGULAR AND PARALLEL ARMS

MODEL #	PRODUCT DESCRIPTION	LIST PRICE
Y1900-1	Regular Arm Assembly Non-Hold Open	\$153.00
1900-1M	Main Arm	\$83.00
Y1900-1W	Main Arm and Adjusting Tube	\$135.00
1900-11	Rod and Shoe	\$59.00
Y1900-5	Parallel Arm Assembly Non-Hold Open	\$153.00
1900-1M	Main Arm	\$83.00
Y1900-1W	Main Arm Less Rod and Soffit Plate	\$135.00
1900-15	Rod and Soffit Plate	\$59.00

RIGID ARMS

MODEL #	PRODUCT DESCRIPTION	LIST PRICE
PR1900-5	Parallel Rigid Arm Non-Hold Open	\$268.00
PR1900-8R	Parallel Rigid Arm Hold Open, Right Hand	\$269.00
PR1900-8L	Parallel Rigid Arm Hold Open, Left Hand	

UNI STOP™ ARMS

MODEL #	PRODUCT DESCRIPTION	LIST PRICE
6130-17	Arm Assembly Non-Hold Open Door Width 28" to 32"	\$591.00
6130-18	Arm Assembly Non-Hold Open Door Width 33" to 41"	
6130-19	Arm Assembly Non-Hold Open Door Width 42" to 48"	
6130-7	Arm Assembly Hold Open Door Width 28" to 32"	\$747.00
6130-8	Arm Assembly Hold Open Door Width 33" to 41"	
6130-9	Arm Assembly Hold Open Door Width 42" to 48"	

MISCELLANEOUS PARTS

MODEL #	PRODUCT DESCRIPTION	LIST PRICE
24BD	B/D Spring	\$237.00
56EF	E/F Spring	\$265.00
1543R	Jackscrew (holder loop to bracket) Right Hand	\$20.60
1543L	Jackscrew (holder loop to bracket) Left Hand	
455	Locknut (holder loop to bracket)	\$19.00
1554	Friction Disc (holder loop)	\$11.60

When Ordering: Specify finish where required.

SCREW PACKS

MODEL #	PRODUCT DESCRIPTION	LIST PRICE
SN-134	Sleeve Nuts Only 1-3/4" Door	\$9.70
SN-214	Sleeve Nuts Only 2-1/4" Door	\$109.00
TBGN 138-38	Through-bolts and Grommet Nuts 1-3/8" door	\$22.00
TBGN 134-38	Through-bolts and Grommet Nuts 1-3/4" door	
TBGN 214-38	Through-bolts and Grommet Nuts 2-1/4" door	

CLOSER BODIES

1902/4LAP	1902/4 Closer Body	\$1,557.00
1905/6LAP	1905/6 Closer Body	

YDC200 SERIES DOOR CLOSER

STANDARD FINISHES: Products will be furnished only in the following finishes.

ANSI/BHMA CODE	FINISH DESCRIPTION
689	Aluminum Painted
690	Dark Bronze Painted

MODEL #	PRODUCT DESCRIPTION	CASE QUANTITY	APPROX. SHIPPING WT. LBS.	689 690
YDC201	Multi-Sized (1-4) Closer - Non-Hold Open	6	6	\$219.00
YDC204	Size 4 Closer with Backcheck - Non-Hold Open	6	6	\$200.00

Note: Sleeve Nuts furnished standard with all models.

MISCELLANEOUS PARTS:

MODEL #	PRODUCT DESCRIPTION	689 690
200COV	Cover Only	\$28.00
SN134	Sleeve Nuts Only – 1-3/4" Thick Door	\$9.70

DOOR ALARM

MODEL #	PRODUCT DESCRIPTION	LIST PRICE
SDA16-1	Battery Operated Door Alarm with YA1 Cam Lock	\$581.00
SDA16XL-1	Battery Operated Door Alarm with Remote Mounting and YA1 Cam Lock	\$671.00
OPTIONS:		
INSIDE CYLINDER: Ordered Separately - See Below		
OUTSIDE CYLINDER: Ordered as 121NL - Specify Cylinder - See Below (Available for SDA16 only)		

NOTE: See page 208 for power supplies and electrified accessories.

CYLINDERS

MODEL	PRODUCT DESCRIPTION	CYLINDER LENGTH	COLLAR SIZE	ALL FINISHES
MORTISE CYLINDERS FOR INSIDE OPTION				
2153	Standard Mortise Cylinder 6-Pin	1-1/8"	N/A	\$108.00
2153	Standard Mortise Cylinder 7-Pin	1-1/4"	N/A	\$110.00
2196	Large Format Interchangeable Core Mortise Cylinder 6-Pin	1-1/2"	KP4	\$194.00
2197	Large Format Interchangeable Core Mortise Cylinder 7-Pin	1-11/16"	1765.250	\$196.00
5153	Security Mortise Cylinder 6-Pin	1-1/8"	N/A	\$425.00
5153	Security Mortise Cylinder 7-Pin	1-1/4"	N/A	\$429.00
5196	Security Large Format Interchangeable Core Mortise Cylinder 6-Pin	1-1/2"	KP4	\$526.00
5197	Security Large Format Interchangeable Core Mortise Cylinder 7-Pin	1-11/16"	1765.250	\$530.00
K100	ACCENTRA KeyMark® Mortise Cylinder 6- or 7-Pin	1-1/8"	N/A	\$126.00
K100	ACCENTRA KeyMark® Mortise Cylinder 6- or 7-Pin	1-1/4"	N/A	
K100	ACCENTRA KeyMark® Mortise Cylinder 6- or 7-Pin	1-1/2"	KP4	\$267.00
K820	ACCENTRA KeyMark® Large Format Interchangeable Core Mortise Cylinder 6-Pin	1-1/2"	KP4	\$234.00
K820	ACCENTRA KeyMark® Large Format Interchangeable Core Mortise Cylinder 6-Pin	1-11/16"	1765.250	
K620	ACCENTRA KeyMark® Small Format Interchangeable Core Mortise Cylinder 6-Pin	1-1/4"	N/A	\$228.00
K620	ACCENTRA KeyMark® Small Format Interchangeable Core Mortise Cylinder 6- or 7-Pin	1-3/8"	N/A	
A620	Best® Keyway Small Format Interchangeable Core Mortise Cylinder 6-Pin	1-1/4"	N/A	\$184.00
A620	Best® Keyway Small Format Interchangeable Core Mortise Cylinder 6- or 7-Pin	1-3/8"	N/A	

MODEL #	PRODUCT DESCRIPTION	RING/ COLLAR	ALL FINISHES
RIM CYLINDERS FOR OUTSIDE OPTION			
1109	Standard Cylinder 6-Pin	1765-.250	\$108.00
1109	Standard Cylinder 7-Pin		\$110.00
1709	CMK Cylinder 6-Pin		\$124.00
1709	CMK Cylinder 7-Pin		\$126.00
1193	Large Format Interchangeable Core Cylinder 6-Pin		\$194.00
1193	Large Format Interchangeable Core Cylinder 7-Pin		\$196.00
5109	Security Cylinder 6-Pin		\$425.00
5109	Security Cylinder 7-Pin		\$429.00
U5109	High Security Cylinder 6-Pin		\$569.00
U5109	High Security Cylinder 7-Pin		\$573.00
5193	Security Large Format Interchangeable Core Cylinder 6-Pin		\$526.00
5193	Security Large Format Interchangeable Core Cylinder 7-Pin		\$530.00
K300	ACCENTRA KeyMark® Cylinder 6- or 7-Pin		\$136.00
K840	ACCENTRA KeyMark® Large Format Interchangeable Core Cylinder 6-Pin or 7-Pin		\$234.00
K640	ACCENTRA KeyMark® Small Format Interchangeable Core Cylinder 6- or 7-Pin		\$228.00
A640	Best® Keyway Small Format Interchangeable Core Cylinder 6- or 7-Pin		\$184.00
2109	Schlage® "C" Keyway Cylinder 6-Pin - 0-bitted or Keyed Random		\$108.00

When Ordering: Specify design, hand and finish.

ELECTRIFIED ACCESSORIES AND WIRING DIAGRAM SERVICES

POWER SUPPLIES:

MODEL #	PRODUCT DESCRIPTION	LIST PRICE
782	Controller - controls two "P" latch retraction exit devices	\$1,277.00
784	9VDC with plug-in wall transformer used with 7116 alarm kits, SDA16 door alarm, nexTouch® touchscreen locks	\$785.00
BPS-24-1	1 AMP @ 24VDC	\$552.00
BPS-24-2	2 AMP @ 24VDC	\$1,123.00
BPS-24-4	4 AMP @ 24VDC	\$1,824.00
BPS-12-1	1 AMP @ 12VDC	\$552.00
BPS-12-3	3 AMP @ 12 VDC	\$1,123.00

WIRE HARNESS:

MODEL #	PRODUCT DESCRIPTION	LIST PRICE
WH-11	Hardwired harness for 36" exit devices used with 7116 alarm kits. Also used with SDA-16.	\$225.00
WH-12	Hardwired harness for 48" exit devices used with 7116 alarm kits.	\$218.00
WH-13	Hardwired harness for 36" surface vertical rod exit devices used with 7116 alarm kits.	\$271.00
WH-14	Hardwired harness for 48" surface vertical rod exit devices used with 7116 alarm kits.	
WH-28	inTouch/nexTouch® remote power and request to enter harness	\$102.00

MISCELLANEOUS ACCESSORIES:

MODEL/PART #	PRODUCT DESCRIPTION	LIST PRICE
EPT	Electrical power transfer = up to 120 degree swing	\$159.00
EPTL	Electrical power transfer – long = over 120 degree swing	\$211.00

ACCENTRA recommends McKinney®, Pemko and Securiton® for power transfer devices and other electronic accessories.

CUSTOM WIRING DIAGRAM SERVICES:

MODEL #	PRODUCT DESCRIPTION	LIST PRICE
WD-BASIC	Basic Riser/Elevation Diagram	Contact 800-810-WIRE for pricing
WD-SPEC	Specification package	
WD-P2P	Point to Point package	
WD-SYSPK	System Package	
WD-SWP	Special Wiring Package	

Note: Consult Electromechanical Technical Services at 800-810-WIRE (9473) to establish the price, type and number of wiring diagrams required for project.

For 8800 Series Electrified Mortise Locksets, see pages 63-66 and 75-77
 For 5400LN Series Electrified Cylindrical Locksets, see page 83
 For 5300LN Series Electrified Cylindrical Locksets, see page 93
 For 4700LN Series Electrified Cylindrical Locksets, see page 99
 For 7000 Series Electrified Exit Devices, see pages 125-126
 For 6000 Series Electrified Exit Devices, see page 143

NEXTOUCH® CYLINDRICAL LOCK

ANSI/BHMA CODE	FINISH DESCRIPTION	PART DESIGNATION
BRASS:		
605	Bright Brass, Clear Coated	003
BRONZE:		
613E	Dark Oxidized Satin Bronze - equivalent	13E

ANSI/BHMA CODE	FINISH DESCRIPTION	PART DESIGNATION
CHROME:		
626	Satin Chrome Plated	025
PAINTED:		
BSP	Black Suede Powder Coat	BSP



PRODUCT OPTIONS	DEDUCT	ADD
CYLINDERS: 6-Pin Only		
LESS CYLINDER OR LESS CORE:		
Standard cylinder prep less cylinder, specify "x LC" Ordering Example: AU-NTB613-NR	\$94.00	—
Large format interchangeable core prep less core, for 6-pin, specify "x 1210 Prep x Less Core" Ordering Example: AU-NTB613-NR x 1210 Prep x Less Core	—	\$0.00
INTERCHANGEABLE CORE CYLINDERS:		
1210 - LFIC 6-Pin (includes MK or GMK) Ordering Example: AU-NTB613-NR x 1210 x 626	—	\$86.00
A600 Best® Keyway SFIC 6-or 7-Pin (includes MK or GMK) Ordering Example: Ordering Example: B-AU-NTB613-NR x A600	—	\$76.00
CYLINDER OPTIONS:		
Lockset with SFIC Core Prep (less core) Prefix B to trim designation. Specify 6 or 7-pin. Ordering Example: B-AU-NTB613-NR x Less Core	\$0.00	\$0.00
Lockset with Medeco®/ASSA® IC Core Prep (less core) Prefix M to trim designation. Not available with MO or PB levers. 6-pin only Ordering Example: M-AU-NTB613-NR x Less Core	\$0.00	\$0.00
Lockset with Schlage® IC Core Prep (less core) Prefix SI to trim designation. 6-pin only. Ordering Example: SI-AU-NTB613-NR x Less Core	\$0.00	\$0.00
Lockset with Corbin Russwin IC Core Prep (less core) Prefix R to trim designation. Not available with MO or PB levers. 6-pin only. Ordering Example: R-AU-NTB613-NR x Less Core	\$0.00	\$0.00
Lockset with Sargent IC Core Prep (less core) Prefix SG to trim designation. Not available with MO levers. 6-pin only. Ordering Example: SG-AU-NTB613-NR x Less Core	\$0.00	\$50.00
Lockset with Schlage® Standard Cylinder Prep (less cylinder) Prefix S to trim designation. 6-pin only. Ordering Example: S-AU-NTB613-NR x Less Cylinder	\$38.00	\$0.00
Lockset with Schlage® "C" Keyway Cylinder (specify cylinder model number 2803-53L) Ordering Example: AU-NTB613-NR x 2803-53L x 626	\$0.00	\$0.00
Lockset with Arrow "AR" Keyway Cylinder (specify cylinder model 100CV1) Ordering Example: AU-NTB-613 x 100CV1 x 626	\$0.00	\$0.00
Lockset with Corbin Russwin "L4", Corbin "60", Russwin "D1", Sargent® "LA" or Schlage® "E" Keyway Cylinder. (specify cylinder model number 3803-53L x keyway) Ordering Example: AU-NTB613-NR x 3803-53L x L4 x 626	\$0.00	\$24.00
ADVANCED FUNCTIONS:		
Lock ordered with auxiliary Door Position Switch to enable Escape, Return and Privacy function. Ordering Example: AU-NTB613-NR x DPS	\$0.00	\$47.00
KNURLING: Available for all levers in 613E, 626 and BSP finishes only		
Outside (KNO) or Inside (KNI) Only	—	\$116.00
Both Sides (KNB)	—	\$232.00
ABRASIVE COATING:		
Outside (ABCO) or Inside (ABCI) Only	—	\$71.00
Both Sides (ABCB)	—	\$142.00
DOOR THICKNESS: 1-3/4" (For 1-3/8" thick doors, thin door kit must be used)	—	STD

NOTES:
SECURITY & ACCENTRA KEYMARK® CYLINDERS: See next page for pricing. These cylinders are priced and discounted separately. Split finishes are not available for the nexTouch® locks.

DESIGNS: Augusta-AU Monroe - MO Pacific Beach - PB Reflections® - TB, UB

MODEL #	PRODUCT DESCRIPTION	ALL FINISHES
NO RADIO OPTIONS		
NTB613-NR	Bored Lock w/Pushbutton Keypad - Cylinder Override	\$856.00
NTB633-NR	Bored Lock w/Pushbutton Keypad - Without Cylinder Override	\$762.00
NTB623-NR	Bored Lock w/Capacitive Touchscreen - Cylinder Override	\$887.00
NTB643-NR	Bored Lock w/Capacitive Touchscreen - Without Cylinder Override	\$793.00

CASE LOT: 3
SHIPPING WEIGHT: 7.2 lbs. per lock

MODEL #	PRODUCT DESCRIPTION	ORDERED SEPARATELY	ORDERED WITH LOCKSET
STRIKES:			
202	Strike Box (Not Plated)	\$2.00	\$2.00
371	Strike 1 1/4" Lip with Box	\$12.00	N/C
371	Strike 1", 1-1/2", 1-3/4" or 2" Lip with Box	\$23.00	\$2.00
497	ANSI Strike Lip 1-1/4"	\$57.00	STD
497	ANSI Strike with 1-1/8", 1-1/2" or 1-3/4" Lip	\$64.00	\$19.00
DEADLOCKING LATCHBOLTS:			
E694	Beveled, 2-3/4" Backset, 1/2" Throw, 2-1/4" x 1-1/8" Front	\$139.00	STD
F694	Flat, 2-3/4" Backset, 1/2" Throw, 2-1/4" x 1-1/8" Front		N/C
480B	Beveled, 2-3/4" Backset, 3/4" Throw, 2-1/4" x 1-1/8" Front	\$265.00	\$126.00
F480B	Flat, 2-3/4" Backset, 3/4" Throw, 2-1/4" x 1-1/8" Front		
380N	2-3/8" Backset, 2-1/4" x 1" Front	\$53.00	N/C

MODEL #	PRODUCT DESCRIPTION	ORDERED SEPARATELY	ORDERED WITH LOCKSET
CYLINDERS:			
1803-53L	Standard Cylinder 6-Pin	\$94.00	N/C
5803-53L	Security Cylinder 6-Pin	\$373.00	\$279.00
K800	ACCENTRA KeyMark® Large Format Interchangeable Core Only 6-Pin	\$126.00	\$126.00
K403-53L	ACCENTRA KeyMark® Cylinder	\$118.00	\$24.00
1210	Large Format Interchangeable Core Only 6-Pin	\$86.00	\$86.00
5210	Security Large Format Interchangeable Core Only 6-Pin	\$343.00	\$343.00
K600	ACCENTRA KeyMark® Small Format Interchangeable Core	\$120.00	\$120.00
2803-53L	Schlage® "C" Keyway Cylinder 6-Pin - 0-bitted or Keyed Random	\$94.00	N/C
3803-53L	Other Manuf. Keyway Cylinder 6-Pin - Keyed Random, Specify Keyway	\$118.00	\$24.00
100CV1	Arrow "AR" Keyway Cylinder	\$94.00	N/C
A600	Best® Keyway Small Format Interchangeable Core 6-or 7-Pin, Specify Keyway	\$76.00	\$76.00
108S	Schlage® Cylinder Adapter Kit	\$28.00	\$28.00

ACCENTRA nexTouch® No Radio lock part numbers NTB613, NTB623, NTB633, & NTB643 can be upgraded for use with the ACCENTRA Cloud platform by installing the Accentra radio module available to all ACCENTRA Multi Family Housing Certified Integrators. **These part numbers can NOT be upgraded to and are not warranted for use with a Z-Wave, Zigbee, or other WiFi compatible system.**

PARTS						
LEVERS ONLY:	PART NUMBER AU	PART NUMBER MO	PART NUMBER PB	PART NUMBER TB	PART NUMBER UB	605 613E 626 BSP
Plain Inside (for use with NTB600)	14-YM00-6040	14-5301-6902	14-5301-6054	14-5301-6201	14-5301-6301	\$88.00
Plain Outside (for use with NTB633/643)	14-YM00-6060	14-5303-6066	14-5303-6062	14-5303-6203	14-5303-6303	
Standard Cylinder Outside (for use with NTB613/623)	14-YM00-6039	14-5305-6056	14-5305-6054	14-5300-6200	14-5300-6300	
SFIC Outside (for use with NTB613/623)	14-YM00-6030	14-5305-0016	14-5305-0012	14-5305-6206	14-5305-6306	\$109.00
LFIC Outside (for use with NTB613/623)	14-YM00-6028	14-5305-6059	14-5305-6051	14-5305-6205	14-5305-6305	
OTHER COMPONENTS:				PART NUMBER		NO FINISH
Motorized Lock Chassis (1-3/8" & 1-3/4" door)				14-5361-0902-048		\$177.00
Battery Cover				14-B600-0200-999		\$56.00

MODEL/PART #	PRODUCT DESCRIPTION	LIST PRICE
ACCESSORIES:		
784	Optional remote 9VDC power supply with plug-in wall transformer	\$785.00
WH-28	Remote power and request to enter wire harness	\$102.00
14-4761-0106	1-3/8" Thin door kit. Includes inside and outside escutcheon spacers as well as a 2-3/8" latchbolt	\$114.00
14-B600-0111-999	3-Wire Door Position Switch	\$47.00

NEXTOUCH® SECTIONAL MORTISE LOCK

ANSI/BHMA CODE	FINISH DESCRIPTION	PART DESIGNATION
BRASS:		
605	Bright Brass, Clear Coated	003
BRONZE:		
613E	Dark Oxidized Satin Bronze - equivalent	13E
CHROME:		
626	Satin Chrome Plated	025
PAINTED:		
BSP	Black Suede Powder Coat	BSP

PRODUCT OPTIONS	DEDUCT	ADD
LESS CYLINDER: Specify "x LC" Cylinder rings/collars not furnished with locksets ordered less cylinders.	\$108.00	—
Hotel Function Locksets - Less Cylinder	\$234.00	—
IC Housing ordered with locksets (ICLC)	—	\$0.00
7-PIN CYLINDERS: Add to 6-Pin cylinder	—	\$2.00
DUST GUARD: Prefix "D" to model number (refer to catalog for available cylinders)	—	\$72.00
INTERCHANGEABLE CORE CYLINDERS:		
2196 - LFIC 6-Pin (Includes MK or GMK) Ordering Example: NTM613 -NR x 2196 x LH x 626	—	\$86.00
A620 - SFIC 6-or 7-Pin (Includes MK or GMK) Ordering Example: NTM613 -NR x A620 x RH x 626	—	\$76.00
TORX® SECURITY HEAD SCREWS: Standard size only (add for each screw)	—	\$1.00
Quantity Required: Sectional Trim = 4	—	\$4.00
SPECIAL STRIKES:		
Strikes with lip lengths other than 1-1/8" or 1-1/4"	—	\$19.00
KNURLING: Available for all knob and levers in any finish except HA, PN and all Reflections® levers		
Outside (KNO) or Inside (KNI) Only	—	\$116.00
Both Sides (KNB)	—	\$232.00
ABRASIVE COATING: Lever		
Outside (ABCO) or Inside (ABCI) Only	—	\$71.00
Both Sides (ABCB)	—	\$142.00
DOORS 1-3/4" THICK TO 2-1/4" THICK:		
Non-keyed	—	\$158.00
Single cylinder keyed	—	\$250.00
Double cylinder keyed	—	\$280.00

NOTE: Split finishes are not available for the nexTouch® locks.

NEXTOUCH® SECTIONAL MORTISE LOCK

DESIGNS: Arcadia - AR* Augusta-AU Carmel - CR Jefferson - JN* Monroe - MO
Pacific Beach - PB Pinehurst - PN* Virginia - VI*

REFLECTIONS DESIGNS: All*

ROSE DESIGNS: R3, R4, R5, R6, R7, R8, R9
Copenhagen - R

*These designs will incur the \$164.00 price adder as established in the standard mortise locks. This includes all Reflections® trim.

MODEL #	PRODUCT DESCRIPTION	ALL FINISHES
NO RADIO OPTIONS		
NTM613-NR	Mortise Lock w/Pushbutton Keypad - Cylinder Override	\$1,194.00
NTM618-NR	Mortise Lock w/Pushbutton Keypad - Cylinder Override w/Thumbturn	\$1,220.00
NTM633-NR	Mortise Lock w/Pushbutton Keypad - Without Cylinder Override	\$1,086.00
NTM638-NR	Mortise Lock w/Pushbutton Keypad - Without Cylinder Override w/Thumbturn	\$1,112.00
NTM623-NR	Mortise Lock w/Capacitive Touchscreen - Cylinder Override	\$1,225.00
NTM628-NR	Mortise Lock w/Capacitive Touchscreen - Cylinder Override w Thumbturn	\$1,251.00
NTM643-NR	Mortise Lock w/Capacitive Touchscreen - Without Cylinder Override	\$1,117.00
NTM648-NR	Mortise Lock w/Capacitive Touchscreen - Without Cylinder Override w/Thumbturn	\$1,143.00

MODEL #	PRODUCT DESCRIPTION	ALL FINISHES
STRIKES:		
2815	Latchbolt and Deadbolt , Curved Lip (8800)	\$57.00
2816	Latchbolt and Deadbolt , Flat Lip (8800)	\$57.00

ACCENTRA nexTouch® No Radio lock part numbers NTM613, NTM618, NTM623, NTM628, NTM633, NTM638, NTM643, & NTM648 can be upgraded for use with the ACCENTRA Cloud platform by installing the Accentra radio module available to all ACCENTRA Multi Family Housing Certified Integrators. **These part numbers can NOT be upgraded to and are not warranted for use with a Z-Wave, Zigbee, or other WiFi compatible system.**

MORTISE MOTORIZED LOCK BODY

PART NUMBER	DESCRIPTION	LIST PRICE
50-M600-0100-014	Lockbody No Deadbolt	\$466.00
50-M605-0100-014	Lockbody w/Deadbolt	\$618.00

FIXED CORE MORTISE CYLINDERS

MODEL #	PRODUCT DESCRIPTION	CAMS	ORDERED SEPARATELY		
2153	Standard Cylinder	1" - 1-3/4"	2160	\$108.00	
2123	Extra Length Cylinder	1-7/8" - 3-1/2"	2160	\$150.00	
2553*	Schlage® "C" Keyway Cylinder 6-Pin - 0-bitted or Keyed Random	1-1/8"	2160	\$108.00	
	7-Pin Cylinders	ADD	--	—	\$2.00

*2553 only available in 606, 612, 613 and 626 finishes.

INTERCHANGEABLE CORE MORTISE CYLINDERS: LFIC

MODEL #	PRODUCT DESCRIPTION	LENGTH	CAM	ALL FINISHES
MORTISE				
2196	LFIC Cylinder 6-Pin	1-1/2", 1-3/4", 2"	2160	\$194.00
2197	LFIC Cylinder 7-Pin	1-11/16", 2"	2160	\$196.00

SECURITY CYLINDERS

MODEL #	PRODUCT DESCRIPTION	CAM	ORDERED SEPARATELY	ORDERED WITH LOCKSET ADD
MORTISE				
5153	Security Cylinder 6-Pin	2160	\$425.00	\$317.00
5153	Security Cylinder 7-Pin	2160	\$429.00	\$321.00

MODEL #	PRODUCT DESCRIPTION	CAM	ORDERED SEPARATELY	ORDERED WITH LOCKSET ADD
MORTISE				
U5153	High Security Cylinder 6-Pin	2160	\$569.00	\$461.00
U5153	High Security Cylinder 7-Pin	2160	\$573.00	\$465.00

SECURITY INTERCHANGEABLE CORE MORTISE CYLINDERS

MODEL #	PRODUCT DESCRIPTION	CAM	ORDERED SEPARATELY	ORDERED WITH LOCKSET ADD
MORTISE				
5196	LFIC Security Cylinder 6-Pin	2160	\$526.00	\$418.00
5197	LFIC Security Cylinder 7-Pin	2160	\$530.00	\$422.00

COMPLETE CYLINDERS: SFIC

Note: A620 include Best® keyway core (A600), specify keyway.

MODEL #	PRODUCT DESCRIPTION	CAM	ALL FINISHES
MORTISE			
A620	SFIC Cylinder 6- or 7-Pin	KC1	\$184.00

ACCENTRA KEYMARK® CYLINDERS, CORES AND HOUSINGS

MORTISE CYLINDERS:

MODEL #	PRODUCT DESCRIPTION	LENGTHS	606/626/BSP FINISHES
K100	Fixed Core Mortise Cylinder	1-1/8", 1-1/4"	\$126.00
K100	Fixed Core Mortise Cylinder	1-1/2", 1-3/4", 2"	\$267.00
K620	SFIC Mortise Cylinder	1-1/4", 1-3/8", 1-3/4"	\$228.00
K630	SFIC Tapered Mortise Cylinder	1-1/4", 1-3/8"	\$231.00
K820	LFIC Mortise Cylinder	1-1/2", 1-11/16", 1-3/4", 2"	\$234.00

MORTISE CORES:

MODEL #	PRODUCT DESCRIPTION	ALL FINISHES
K600*	SFIC Core	\$120.00
K800	LFIC Core	\$126.00
K890	LFIC Core for Schlage	\$126.00

*K600 available in 606 and 626 only.

MORTISE HOUSINGS:

MODEL#	PRODUCT DESCRIPTION	LENGTHS	ALL FINISHES
K660	SFIC Mortise Housing	1-1/4", 1-3/8", 1-3/4"	\$108.00
K670	SFIC Tapered Mortise Housing	1-1/4", 1-3/8"	\$111.00
K860	LFIC Mortise Housing	1-1/2", 1-11/16", 1-3/4", 2"	\$108.00

When Ordering: Specify finish.
Specify ring/collar size when ordering with cylinder.

CYLINDER COMPONENTS & OPTIONS

***CYLINDER COLLARS:**

MODEL #	PRODUCT DESCRIPTION	ALL FINISHES
KP3	Wave Washer	\$6.00
1765	.062" - .219"	\$51.00
	.250" - .656"	
1766	Tubular Spacer Collar for Mortise and Rim High Security	\$73.00
1767	Square Collar for Mortise and Rim	\$83.00

*Specify dimension. Cylinder collars not furnished with locksets or other products when ordered less cylinders. When cylinders ordered separately, collar length must be specified.

MODEL/PART #	PRODUCT DESCRIPTION	LIST PRICE
SECTIONAL MORTISE SCAR PLATE KITS (includes 1 o/s plate & 1 i/s plate):		
50-M600-0150-033	O/S with cylinder - I/S no thumbturn	\$135.00
50-M600-0151-033	O/S no cylinder - I/S no thumbturn	
50-M600-0152-033	O/S with cylinder - I/S with thumbturn	
50-M600-0153-033	O/S no cylinder - I/S with thumbturn	

Can be used to cover door preps for SARGENT Profile Series v.G1.5 and Corbin Russwin Access 800 series locksets to enable replacement with nexTouch®.

MODEL/PART #	PRODUCT DESCRIPTION	LIST PRICE
ACCESSORIES:		
784	Optional remote 9VDC power supply with plug-in wall transformer	\$785.00
WH-28	Remote power and request to enter wire harness	\$102.00

ANSI/BHMA CODE	FINISH DESCRIPTION	PART DESIGNATION
BRASS:		
605	Bright Brass, Clear Coated	003
BRONZE:		
613E	Dark Oxidized Satin Bronze - equivalent	13E
CHROME:		
626	Satin Chrome Plated	025
PAINTED:		
BSP	Black Suede Powder Coat	BSP

PRODUCT OPTIONS	DEDUCT	ADD
LESS CYLINDER: Specify "x LC" Cylinder rings/collars not furnished with locksets ordered less cylinders.	\$108.00	—
IC Housing ordered with locksets (ICLC)	—	\$0.00
7-PIN CYLINDERS: Add to 6-Pin cylinder	—	\$2.00
DUST GUARD: Prefix "D" to model number (refer to catalog for available cylinders)	—	\$72.00
INTERCHANGEABLE CORE CYLINDERS:		
2196 - LFIC 6-Pin (Includes MK or GMK) Ordering Example: NTT613-NR x 2196 x LHR x 626	—	\$86.00
A620 - SFIC 6-or 7-Pin (Includes MK or GMK) Ordering Example: NTT613-NR x A620 x RHR x 626	—	\$76.00
ADVANCED FUNCTIONS:		
Lock ordered with auxiliary Door Position Switch to enable Escape, Return and Privacy function. Ordering Example: AU-NTT613-NR x DPS	\$0.00	\$47.00
TORX® SECURITY HEAD SCREWS: Standard size only (add for each screw)	—	\$1.00
Quantity Required: Sectional Trim = 4	—	\$4.00

NOTE: Split finishes are not available for the nexTouch® locks.

DESIGNS: Augusta-AU Monroe - MO Pacific Beach - PB

MODEL #	PRODUCT DESCRIPTION	ALL FINISHES
NO RADIO OPTIONS		
NTT613-NR	Exit Rim Trim w/Pushbutton Keypad - Cylinder Override	\$1,137.00
NTT623-NR	Exit Rim Trim w/Capacitive Touchscreen - Cylinder Override	\$1,168.00

ACCENTRA nexTouch® No Radio lock part numbers NTT613 & NTT623 can be upgraded for use with the ACCENTRA Cloud platform by installing the ACCENTRA radio module available to all ACCENTRA Multi Family Housing Certified Integrators. **These part numbers can NOT be upgraded to and are not warranted for use with a Z-Wave, Zigbee, or other WiFi compatible system.**

FIXED CORE MORTISE CYLINDERS

MODEL #	PRODUCT DESCRIPTION	ALL FINISHES
2153	Standard Cylinder	\$108.00
2553*	Schlage® "C" Keyway Cylinder 6-Pin - 0-bitted or Keyed Random	\$108.00
7PIN	7 Pin Adder	\$2.00

*2553 only available in 606, 612, 613 and 626 finishes.

INTERCHANGEABLE CORE MORTISE CYLINDERS: LFIC

MODEL #	PRODUCT DESCRIPTION	LENGTH	CAM	ALL FINISHES
MORTISE				
2196	LFIC Cylinder 6-Pin	1-1/2", 1-3/4", 2"	2160	\$194.00
2197	LFIC Cylinder 7-Pin	1-11/16", 2"	2160	\$196.00

SECURITY INTERCHANGEABLE CORE MORTISE CYLINDERS

MODEL #	PRODUCT DESCRIPTION	CAM	ORDERED SEPARATELY	ORDERED WITH LOCKSET ADD
SECURITY CYLINDERS				
5153	Security Cylinder 6-Pin	2160	\$425.00	\$317.00
MORTISE				
5196	LFIC Security Cylinder 6-Pin	2160	\$526.00	\$418.00
5197	LFIC Security Cylinder 7-Pin	2160	\$530.00	\$422.00

COMPLETE CYLINDERS: SFIC

Note: A620 include Best® keyway core (A600), specify keyway.

MODEL #	PRODUCT DESCRIPTION	CAM	ALL FINISHES
MORTISE			
A620	SFIC Cylinder 6- or 7-Pin	KC1	\$184.00

ACCENTRA KEYMARK® CYLINDERS, CORES AND HOUSINGS

MORTISE CYLINDERS:

MODEL #	PRODUCT DESCRIPTION	LENGTHS	ALL FINISHES
K100	Fixed Core Mortise Cylinder	1-1/8", 1-1/4"	\$126.00
K620	SFIC Mortise Cylinder	1-1/4", 1-3/8", 1-3/4"	\$228.00
K820	LFIC Mortise Cylinder	1-1/2", 1-11/16", 1-3/4", 2"	\$234.00

MORTISE HOUSINGS:

MODEL#	PRODUCT DESCRIPTION	LENGTHS	ALL FINISHES
K660	SFIC Mortise Housing	1-1/4", 1-3/8", 1-3/4"	\$108.00
K670	SFIC Tapered Mortise Housing	1-1/4", 1-3/8"	\$111.00

When Ordering: Specify finish.

Specify ring/collar size when ordering with cylinder.

***CYLINDER COLLARS:**

MODEL #	PRODUCT DESCRIPTION	ALL FINISHES
1765	.062" - .219"	\$51.00
	.250" - .656"	

*Specify dimension. Cylinder collars not furnished with locksets or other products when ordered less cylinders. When cylinders ordered separately, collar length must be specified.

MODEL/PART #	PRODUCT DESCRIPTION	LIST PRICE
ACCESSORIES:		
784	Optional remote 9VDC power supply with plug-in wall transformer	\$785.00
WH-28	Remote power and request to enter wire harness	\$102.00
14-B600-0111-999	3-Wire Door Position Sensor	\$47.00

ACCENTRA

ASSA ABLOY

The ASSA ABLOY Group is the global leader in access solutions. Every day, we help billions of people experience a more open world.

ASSA ABLOY Opening Solutions leads the development within door openings and products for access solutions in homes, businesses and institutions. Our offering includes doors, frames, door and window hardware, mechanical and smart locks, access control and service.

MicroShield®

ASSA ABLOY Group companies offer MicroShield®, an anti-microbial coating for door hardware. MicroShield uses proven silver ion-based technology from Agion®, a leading provider of antimicrobial solutions, to stem the spread of bacteria and other microbes.

MicroShield® is a registered trademark of ASSA ABLOY Access and Egress Hardware Group, Inc.



The Agion antimicrobial is not intended as a substitute for good hygiene. Coated products must still be cleaned to ensure the surfaces will be free of destructive microbes. ASSA ABLOY makes no representations or warranties, express or implied, as to the efficacy of the Agion antimicrobial. A copy of the Agion warranty is available upon request. Agion is a registered trademark of Agion Technologies, Inc., Wakefield, MA, USA.

PHONE

1-855-557-5078

CUSTOMER SERVICE EMAIL

customerservice.accentra@assaabloy.com

TECHNICAL PRODUCT SUPPORT EMAIL

techsupport.accentra@assaabloy.com

ORDER ENTRY EMAIL

orders.accentra@assaabloy.com

FAX

1-800-338-0965

WEBSITE

www.accentra-assabloy.com

U.S.A.:

ASSA ABLOY ACCENTRA™
225 Episcopal Road
Berlin, CT 06037-4004
Tel: 1-800-438-1951
Fax: 1-800-338-0965
www.accentra-assaabloy.com

Canada:

ASSA ABLOY Door Security Solutions Canada
160 Four Valley Drive
Vaughan, Ontario L4K 4T9
Tel: 1-800-461-3007
Fax: 1-800-461-8989
assaabloydss.ca

International:

ASSA ABLOY Americas International
Tel: 1-905-821-7775
Fax: 1-905-821-1429
assaabloyai.com