

10X Line

Cylindrical Lever Lock



Table of Contents

10X Line Cylindrical Lever Locks

Overview.....	3
Certifications.....	4
Technical Details - Lever Trim.....	5
Lever & Rose Designs.....	6
Behavioral Health - BHW Trim.....	7
Visual Status Indicators.....	8-9
Red Button Option & Key Turn Indicator.....	10
Functions.....	11-13
Technical Details - Electrified Lock.....	14
Electrical Accessories.....	15
Cylinders.....	16-17
Latches.....	18
Strikes and Miscellaneous Parts.....	19
Cylinder Options.....	20-21
Mechanical Options.....	22
Finishes, Packaging.....	23
How to Order.....	24
Architectural Specifications.....	25-28

MicroShield®

ASSA ABLOY Group companies offer MicroShield®, an antimicrobial coating for door hardware. MicroShield uses proven silver ion-based technology from Agion®, a leading provider of antimicrobial solutions, to stem the spread of bacteria and other microbes.

MicroShield® is a trademark of ASSA ABLOY Access and Egress Hardware Group, Inc.

MicroShield® Coating

- Revolutionary finish coating available on all SARGENT product lines, utilizes a silver-based antimicrobial compound from Agion Technologies
- As an integral part of the finish coating, MicroShield lasts for the life of the hardware
- MicroShield coating permanently suppresses the growth of bacteria, algae, fungus, mold and mildew. It is effective against a broad spectrum of bacteria.
- Non-toxic and completely safe. The Agion antimicrobial compound is EPA and NSF approved and FDA listed for use in medical and food preparation equipment.
- Applications: Anywhere there is need for a clean environment (hospitals, laboratories, schools, medical centers, daycare, food processing etc.)



The Agion antimicrobial is not intended as a substitute for good hygiene. Coated products must still be cleaned to ensure the surfaces will be free of destructive microbes. ASSA ABLOY makes no representations or warranties, express or implied, as to the efficacy of the Agion antimicrobial. A copy of the Agion warranty is available upon request. Agion is a registered trademark of Agion Technologies, Inc., Wakefield, MA, USA.

WARNING

This product can expose you to lead which is known to the state of California to cause cancer and birth defects or other reproductive harm. For more information go to www.P65warnings.ca.gov.

On The Cover

- 10XG05 x LMB Entrance Function

Overview

10X Line Cylindrical Lever Locks

SARGENT
ASSA ABLOY

The SARGENT 10X Line is engineered to secure and protect high-traffic, high-abuse spaces. It doesn't simply meet ANSI/BHMA Grade 1 performance standards for durability, strength and performance, it exceeds them - by as much as 20 times. That means occupants enjoy consistent performance for the life of the product.

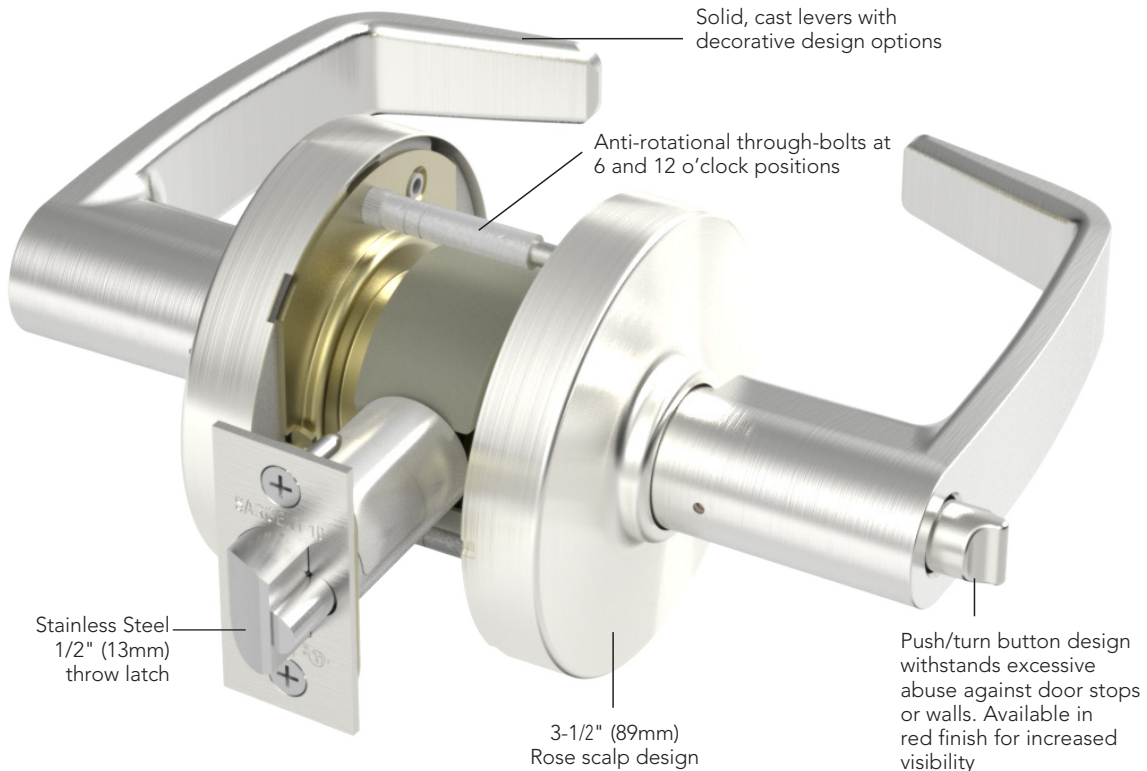

Applications

- Heavy duty commercial and institutional interior and exterior doors
- Offices
- Schools/Universities
- Hospitals
- Manufacturing facilities
- Government

Certifications

10X Line Cylindrical Lever Locks

Certification/Compliance

ANSI/BHMA	Certified ANSI/BHMA A156.2 (2022) Series 4000 — Grade 1 Certified ANSI/BHMA A156.41
UL/cUL	UL/cUL listed to US and Canadian safety standards for 3 hour doors up to 4' x 10' (double doors require 41- option)
UL294	Listed as an Access Control Accessory (10XG70 & 10XG71)
NFPA 80	Conforms for life safety and property protection, Standard for Fire Doors and Other Opening Protectives
Positive Pressure	Meets ANSI/UL 10C, Positive Pressure Fire Test of Door Assemblies
ADA	The force required to activate all levers shall be 5 pounds (22.2N) maximum. All levers conform to ADA clear opening width requirements of ANSI A117.1.
California State Reference Code (Formerly Title 19, California State Fire Marshal Standard)	All levers with returns comply; levers return to within 1/2" (13mm) of door face
Windstorm/Hurricane	All individual components of a total door opening are required to comply with each code.

Any retrofit or other field modification to a fire rated opening can potentially impact the fire rating of the opening, and Sargent Manufacturing Company makes no representations or warranties concerning what such impact may be in any specific situation. When retrofitting any portion of an existing fire rated opening, or specifying and installing a new fire-rated opening, please consult with a code specialist or local code official (Authority Having Jurisdiction) to ensure compliance with all applicable codes and ratings.

Windstorm Certifications: Florida Building Codes & UL Listings

SARGENT Manufacturing's products meet building codes that require hurricane and windstorm certifications, including some of the most stringent building codes as specified in the Florida Building Code, Miami Dade Code and the International Building Code. Listed below are certifications and standards met by the 10X Line locks.

Florida Building Code: FL2998

UL Certification Directory: ZHEM.R21744 – Latching Hardware

ANSI/SDI A250.13 (2014)	"Testing and Rating of Severe Windstorm Resistant Components for Swinging Door Assemblies"
ASTM E330 (2002)	"Standard Test Method for Structural Performance of Exterior Windows, Doors, Skylights and Curtain Walls by Uniform Static Air Pressure Difference"*
ASTM E1886 (2005)	"Standard Test Method for Performance of Exterior Windows, Curtain Walls, Doors, and Impact Protective Systems Impacted by Missile(s) and Exposed to Cyclic Pressure Differentials"*
ASTM E1996 (2009)	"Standard Specification for Performance of Exterior Windows, Curtain Walls, Doors and Impact Protective Systems Impacted by Windborne Debris in Hurricanes"*
(TAS) 201 (1994)	"Impact Test Procedures"*
(TAS) 202 (1994)	"Standard Test Method for Structural Performance of Exterior Windows, Doors, Skylights and Curtain Walls by Uniform Static Air Pressure Difference"*
(TAS) 203 (1994)	"Criteria for Testing Products Subject to Cyclic Wind Pressure Loading"*

* Published in the 7th Edition (2020), "Florida Building Code" (FBC), State Product Approval Number FL2998

UL Certification Directory: ZHLL.R21744 – Products for Use in Windstorm-rated Assemblies

Certifications to meet assembly requirements are done in conjunction with doors from ASSA ABLOY Group companies CECO DOOR and CURRIES.

ASTM E330 (2002)	"Standard Test Method for Structural Performance of Exterior Windows, Doors, Skylights and Curtain Walls by Uniform Static Air Pressure Difference"
ASTM E1886 (2005)	"Standard Test Method for Performance of Exterior Windows, Curtain Walls, Doors, and Impact Protective Systems Impacted by Missile(s) and Exposed to Cyclic Pressure Differentials"
ASTM E1996 (2009)	"Standard Specification for Performance of Exterior Windows, Curtain Walls, Doors and Impact Protective Systems Impacted by Windborne Debris in Hurricanes"

Copyright © 2021-2025, Sargent Manufacturing Company, an ASSA ABLOY Group company. All rights reserved. Reproduction in whole or in part without the express written permission of Sargent Manufacturing Company is prohibited.

Technical Details

10X Line Cylindrical Lever Locks with Lever Trim

Door Prep	ANSI/SDI A250.14
Door Thickness	1-3/4" (44mm) thick door adjusts to 2" (51mm) standard 1-3/8" (35mm) thick door, specify 1- Option for Adapter plates Over 2" (51mm) up to 2-1/4" (57mm), specify 31- Option Over 2-1/4" (57mm) up to 6" (152mm) available by special application, contact Technical Product Support
Minimum Stile	4-1/2" (114mm)
Handing	Non-handed
Backset	2-3/4" (70mm) backset w/ 1-1/8" (29mm) front (standard) 2-3/8" (60mm) backset w/ 1" (25mm) wide front (specify 20- Option) 3-3/4" (95mm) backset w/ 1-1/8" (29mm) front (specify 23- Option) 5" (127mm) backset w/ 1-1/8" (29mm) front (specify 25- Option)
Latchbolt	Stainless steel, 1/2" (13mm) throw Optional: Brass 3/4" (19mm) throw deadlocking fire latch for pair of doors (specify 41- Option)
Front	Wrought brass and stainless steel 2-1/4" x 1-1-8" (57mm x 29mm) Fixed Bevel 2-1/4" x 1" (57mm x 25mm) (included with 20- Option)
Strike	Wrought brass, bronze and stainless steel 808 curved lip ANSI 4-7/8" strike - standard 800 curved lip strike (specify 29- Option) Wrought box strike available (specify WBS- Option)
Cylinder	Brass, 6-pin LA keyway, 1-bitted standard, specify KD for keyed different/random (see Options pages 20-21)
Keys	Two nickel silver change keys per lock standard
Masterkeying	Can be master keyed or grand master keyed Construction key systems available
Lead Lining	Lead provided between lockbody and spring cartridge (specify 74- Option)
Tactile Levers	Knurling (etching) or abrasive coating (applied finish) applied to backside of levers (see Options page 22)
Finishes	See page 23
Behavioral Health	Compatible with BHW trim (see page 7)
Visual Status Indicators	Compatible with VSL trim (see page 8)
Warranty	Ten-year limited

Strength & Durability

- UL Cycle above and beyond test completed at 20 Million Cycles.
Verification ID: V584148
- Exceeds 3,100 in-lb abusive locked lever torque with no entry while maintaining egress (2.6 times ANSI/BHMA A156.2 requirements)
- Exceeds 1,600 lbs offset lever pull with no entry for protection against attacks (8 times ANSI/BHMA A156.2 requirements)
- Latch retraction with 100lb preload (2 times ANSI/BHMA A156.2) while maintaining ANSI/BHMA requirements for operation in warped doors
- No access with minimum 100 vertical impacts for protection against vandalism attempts (20 times ANSI/BHMA A156.2 requirements)
- Independent return springs allow lock to exceed ANSI/BHMA A156.2 Grade 1 cycle requirements without lever sag
- Innovative push/turn button design to withstand excessive abuse against door stops or walls.

Flexibility

- Lock chassis design supports all cylinder formats allowing flexibility for from fixed core to interchangeable core cylinders.
- High Security and security key systems available (Degree®, Signature, Keso, XC)
- Patented adjustable push/turn button for easy door thickness adjustment.
- Rigid lever standard; freewheeling levers available for vandal resistance.

Broad Offering

- Available with 27 mechanical and 2 electrified functions
- 14 finishes plus MicroShield® options
- Multiple lever options including decorative, behavioral health and visual status indicators

Lever & Rose Designs

10X Line Cylindrical Lever Locks

Levers - Solid Cast Zinc

B

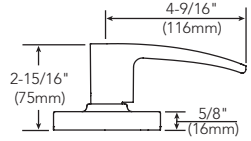

L*

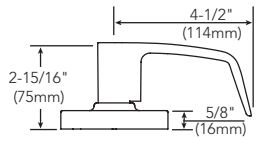

P*

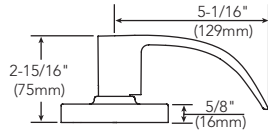

Decorative Levers

MD

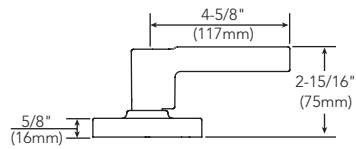

ND*

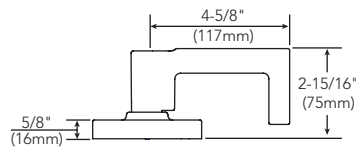

Roses - Wrought Brass or Bronze

G

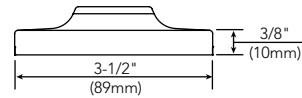

L

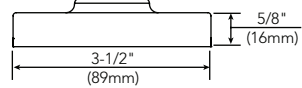

Any rose or lever on this page can be combined to suit individual taste.

All lever height measurements represent total distance from door face. Dimensions shown using L rose.

*Lever with return to within 1/2" of door face.

Copyright © 2021-2025, Sargent Manufacturing Company, an ASSA ABLOY Group company. All rights reserved. Reproduction in whole or in part without the express written permission of Sargent Manufacturing Company is prohibited.

Behavioral Health

10X Line Cylindrical Lever Locks with BHW Trim*

Part of the Behavioral Health Series® of products, the 10X Line cylindrical lock with BHW trim has tapered surfaces and an integrated lever and escutcheon, bringing an elegant style to behavioral health environments. The BHW trim is listed for low, medium and high risk areas in the widely recognized New York State Office of Mental Health (NYS-OMH) Patient Safety Standard.* The heavy-duty design and ANSI/BHMA Grade 1 strength of the 10X Line withstands abuse in any environment.

BHW

Lever & Escutcheon - Cast Stainless Steel

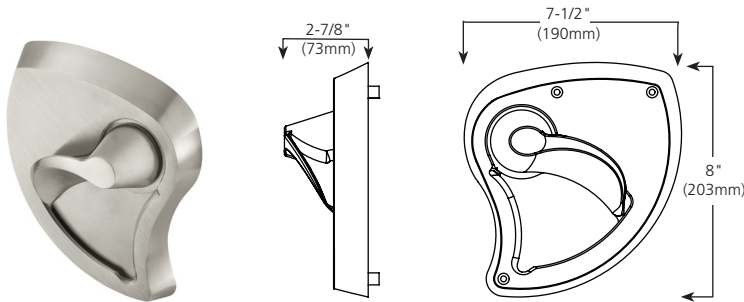

Door Prep	ANSI/SDI A250.14 modified. Refer to template 4753
Door Thickness	1-3/4" (44mm) thick door adjusts to 2" (51mm)
Minimum Stile	8-1/2" (216mm)
Handing	Handed - must be specified on order
Backset	2-3/4" (70mm) backset w/ 1-1/8" (29mm) front (standard) 3-3/4" (95mm) backset w/ 1-1/8" (29mm) front (specify 23- Option) 5" (127mm) backset w/ 1-1/8" (29mm) front (specify 25- Option)
Latchbolt	Stainless steel, 1/2" (13mm) throw
Front	Wrought brass and stainless steel 2-1/4" x 1-1-8" (57mm x 29mm) Fixed Bevel
Strike	Wrought brass, bronze and stainless steel 808 curved lip ANSI 4-7/8" strike - standard 800 curved lip strike (specify 29- Option) Wrought box strike available (specify WBS- Option)
Cylinder	Brass, 6-pin LA keyway, 1-bitted standard, specify KD for keyed different/random. (see Options pages 20-21)
Keys	Two nickel silver change keys per lock standard
Masterkeying	Can be master keyed or grand master keyed Construction key systems available
Lead Lining	Lead provided between lockbody and spring cartridge (specify 74- Option)
Fasteners	6-Lobe security head Torx® standard for exposed fasteners
Finish	32D
Functions	Available with functions as shown on pages 11-14 with the BHW icon 
Outside Locked Lever	Free-wheeling (FW-) or rigid* (RGD) option for outside locked lever MUST be specified for the following functions: 10XG04, 10XG05, 10XG17, 10XG24, 10XG26, 10XG37, 10XG54, 10XU65, 10XG70 and 10XG71
Warranty	Ten-year limited for mechanical and two-year limited electronics

*Although this product is better designed for behavioral health applications than traditional trim, it does not eliminate the risk that an object can be affixed to, or around it. A lockset function that requires a rigid lever when locked or a push/turnbutton may introduce a ligature opportunity. Refer to [Patient Safety Standards Guidelines](https://omh.ny.gov/omhweb/patient_safety_standards/) for the latest approved products (https://omh.ny.gov/omhweb/patient_safety_standards/).

Indicators

10X Line Cylindrical Lever Locks with VSL Trim

The 10X Line cylindrical lock with status indicators, is the ultimate intersection of security and privacy. Engineered for easy installation in any space, it ensures instant visibility of the door's lock status. Featuring six customizable status indicator windows for optimal visibility, it offers indicators for both sides of the door, one-motion egress, non-handed installation, and keyed functions. Built on the robust 10X Line lock body, it exceeds Grade 1 standards, making it ideal for high-traffic restrooms, classrooms, or rooms requiring additional privacy.

Features

- Patented design
- Inside, outside or **both** sides of the door
 - Indicator option code must be specified, see page 9.
- Highly visible from all angles
- Non-handed
- Multiple door thickness options
- Available with a variety of functions

VSL

Lever - Solid Cast Zinc
Rose - Wrought Brass

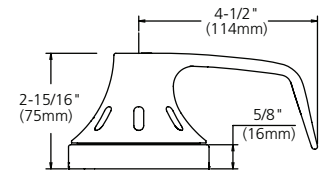

Door Prep	ANSI/SDI A250.14
Door Thickness	1-3/4" (44mm) standard - accomodates 1-11/16" - 1-15/16" (43mm - 49mm) doors 1-3/8" (35mm) specify 1- Option for adapter plates 2" (51mm) specify 31- Option & 2" - accomodates 1-15/16" - 2-1/8" (49mm - 54mm) doors 2-1/4" (57mm) specify 31- Option & 2-1/4" - accomodates 2-1/8" - 2-5/16" (54mm - 59mm) doors
Minimum Stile	4-1/2" (114mm)
Handing	Non-handed
Backset	2-3/4" (70mm) backset w/ 1-1/8" (29mm) front (standard) 3-3/4" (95mm) backset w/ 1-1/8" (29mm) front (specify 23- Option) 5" (127mm) backset w/ 1-1/8" (29mm) front (specify 25- Option)
Latchbolt	Stainless steel, 1/2" (13mm) throw
Front	Wrought brass and stainless steel 2-1/4" x 1-1-8" (57mm x 29mm) Fixed Bevel
Strike	Wrought brass, bronze and stainless steel 808 curved lip ANSI 4-7/8" strike - standard 800 curved lip strike (specify 29- Option) Wrought box strike available (specify WBS- Option)
Cylinder	Brass, 6-pin LA keyway, 1-bitted standard, specify KD for keyed different/random. (see Options pages 20-21)
Keys	Two nickel silver change keys per lock standard
Masterkeying	Can be master keyed or grand master keyed Construction key systems available
Lead Lining	Lead provided between lockbody and spring cartridge (specify 74- Option)
Finishes	See page 23
Functions	Available with functions as shown on pages 11-13 with the VSL icon 
Outside Locked Lever	Rigid outside locked levers provided standard. For free-wheeling levers specify FW- Option.
Warranty	Ten-year limited

Copyright © 2021-2025, Sargent Manufacturing Company, an ASSA ABLOY Group company. All rights reserved. Reproduction in whole or in part without the express written permission of Sargent Manufacturing Company is prohibited.

Indicators

10X Line Cylindrical Lever Locks with VSL Trim

Functions

Indicators are available with the following 10X Line functions.

Function	Description
10XG04	Storeroom or Closet (F86)
10XG05	Entrance or Office (F109)
10XG14	Patio or Privacy (F77A)
10XG24	Entrance or Office (F82A)
10XG37	Classroom (F84)
10XG38	Classroom Security Intruder (F110) Inside only*
10XG44	Service Station (F92)
10XG53	Corridor, Dormitory
10XG54	Corridor, Dormitory (F90) Outside only
10XU65	Privacy/Bathroom (F76A)
10XU66	Privacy/Bathroom (F76A)
10XU68	Hospital Privacy

*Provided standard with Key Turn Indicator as shown on page 10.

How To Order

When ordering 10X Line indicator trim, the VSLL trim designation must be specified in addition to the indicator option code.

If indicators are specified on one side of the door only, the non-indicator side will be supplied with LL trim unless otherwise ordered.

How To Order Examples

Indicator Outside Only

Options	Function	Outside Design & Trim	Inside Design & Trim	Hand	Finish
V30	10XU65	VSLL	LL	RH	26D

Privacy function with indicator on **outside only in green/red**. Inside would be provided with LL trim.

Options	Function	Outside Design & Trim	Inside Design & Trim	Hand	Finish
V30	10XG24	VSLL	LMD	RH	26D

Entry function with indicator on **outside only in green/red**. Inside would be provided with LMD trim.

Indicator Inside Only

Options	Function	Outside Design & Trim	Inside Design & Trim	Hand	Finish
V06	10XU65	LL	VSLL	RH	26D

Privacy function with indicator on **inside only in white/red**. Outside would be provided with LL trim.

Options	Function	Outside Design & Trim	Inside Design & Trim	Hand	Finish
V06	10XU65	LMD	VSLL	RH	26D

Privacy function with indicator on **inside only in white/red**. Outside would be provided with LMD trim.

Indicator Both Sides

Options	Function	Trim	Design	Hand	Finish
V33	10XU65	VSL	L	RH	26D

Privacy function with indicator on **both sides in green/red**.

Indicator Option Codes

10X Line indicator option codes are designed to convey color and side of door desired in one simple code. To order, specify option code.

Single Indicator			
Option Code	Outside	Inside	Color
V30	Indicator Trim	Standard Trim	Green/Red
V60	Indicator Trim	Standard Trim	White/Red
V03	Standard Trim	Indicator Trim	Green/Red
V06	Standard Trim	Indicator Trim	White/Red

Double Indicator			
Option Code	Outside	Inside	Color
V33	Indicator Trim	Indicator Trim	Green/Red
V66	Indicator Trim	Indicator Trim	White/Red



Indicators

10X Line Cylindrical Lever Locks

Red Button Option

The 10X Line locksets are available with a red push or turn button for increased visibility to status.

Providing the red push button allows users to easily see if the button is pushed in to indicate the outside lever is locked.



Features

- Available for all push/turn button functions
- Bright red powder coat finish to easily see from a distance
- Economical solution for status indication

How to Order

Specify option code "RPB".

Available with the following functions:

Function	Description
10XG05	Entry (F109)
10XG14	Patio (F77A)
10XG24	Entry (F82A)
10XG44	Service Station (F92)
10XG50	Hotel (F93)
10XG53	Dormitory
10XG54	Dormitory (F90)
10XU65	Privacy (F76A) Coin turn
10XU66	Privacy (F76A) EM Key
10XU68	Hospital Privacy (Inside only)

Order Example

Option	Function	Trim	Finish	Hand
RPB-	10XU65	LL	26D	RH

Key Turn Indicator

The 10XG16 & 10XG38 Classroom functions allow locking of the outside lever from the inside with the key. The Key Turn Indicator is provided standard on the inside rose* for these functions and in a panic situation, it serves as a quick reference for locking the door. Egress is always possible with the "anti-panic" feature, which keeps the outside lever locked if the inside lever is activated.

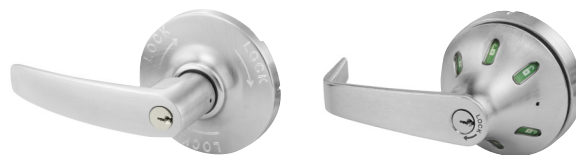

Standard Trim

Indicator Trim



*Provided on lever for VSL indicator trim.

Functions

10X Line Cylindrical Lever Locks

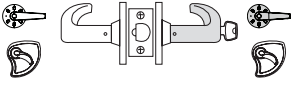
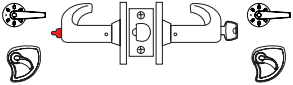
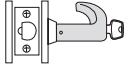
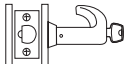
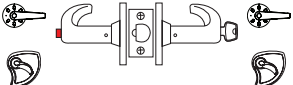
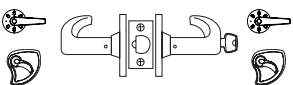
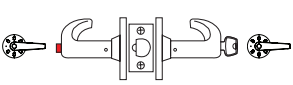
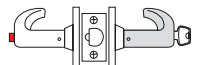
Single Cylinder Functions

Inside/Outside	Series/ Function	Type	ANSI No.	Function Description
	10XG04	Storeroom or Closet	F86	<ul style="list-style-type: none"> Deadlocking latch Latch by lever inside or key outside Outside lever locked at all times
	10XG05	Entrance or Office	F109	<ul style="list-style-type: none"> Deadlocking latch Latch by either lever unless outside lever is locked by push/turn button in inside lever Push button released by key outside or lever inside Turn button must be released manually Key retracts latch when outside lever is locked
	10XG07	Communicating Storeroom	F112	<ul style="list-style-type: none"> Deadlocking latch Latch by key Lever locked at all times Lever on one side; blank plate on other side
	10XG08	Communicating Classroom	F113	<ul style="list-style-type: none"> Deadlocking latch Latch by lever unless lever is locked by key Key in lever locks or unlocks lever and retracts latch Lever on one side; blank plate on other side
	10XG24	Entrance or Office	F82A	<ul style="list-style-type: none"> Deadlocking latch Latch by either lever unless outside lever is locked by push button in inside lever Push button released by key or turning inside lever Closing door does not unlock outside lever or release button Key in outside lever retracts latch when outside lever is locked and releases inside push button
	10XG37	Classroom	F84	<ul style="list-style-type: none"> Deadlocking latch Latch by either lever unless outside lever is locked by key Key in outside lever locks or unlocks outside lever and retracts latch Inside lever always operative
	10XG44	Service Station	F92	<ul style="list-style-type: none"> Deadlocking latch Latch by either lever unless outside lever is locked by push button in inside lever Key retracts latch when outside lever is locked Push button released by turning inside lever, closing door, or by key in outside lever unless push button is fixed in locked position by turning coin slot in inside lever Slotted inside button must be manually released
	10XG50	Hotel, Dormitory or Apartment	F93	<ul style="list-style-type: none"> Deadlocking latch Latch by key outside and lever inside Outside lever always locked Depressing push button when door is closed shuts out all keys except emergency key and projects visual occupancy indicator in cylinder face Push button released by turning inside lever or by closing door, unless push button has been fixed in locked position by spanner key (provided). When push button is fixed in locked position by spanner key, lock is operable only by emergency key. See option page for restrictions to 50 function Emergency key ordered separately. Part # 6267EMK plus key system registry number

 Shaded lever indicates it is rigid/locked at all times.
 Freewheeling locking levers available on all locking functions, specify FW- Option.

 Indicates function available with BHW trim.

 Indicates function available with RPB option.

 Indicates function available with VSL trim.



Functions

10X Line Cylindrical Lever Locks

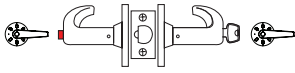
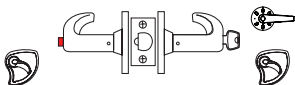
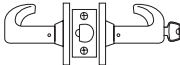

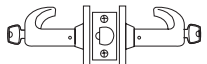

Single Cylinder Functions

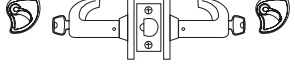
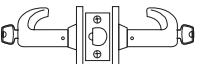
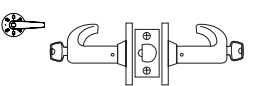
Inside/Outside	Series/ Function	Type	ANSI No.	Function Description
	10XG53	Corridor, Dormitory	Modified F90	<ul style="list-style-type: none"> Deadlocking latch Latch by either lever unless outside lever is locked by push button inside or key outside Key outside locks or unlocks outside lever and also retracts latchbolt when locked When outside lever is locked by push button or key, it can be unlocked by key, rotating inside lever or closing door
	10XG54	Corridor, Dormitory	F90	<ul style="list-style-type: none"> Deadlocking latch Latch by either lever unless outside lever is locked by push button inside or key outside Rotating inside lever or closing door releases inside button only, but does not unlock the outside lever if locked by key Key outside locks or unlocks outside lever and also retracts latchbolt when locked
	10XG60	Barrier Free Storeroom/ Public Restroom	—	<ul style="list-style-type: none"> Deadlocking latch Latch by lever inside Key in outside lever unlocks outside lever to retract latch Key is retained in unlock mode When key is removed outside lever is locked

Double Cylinder Functions

Inside/Outside	Series/ Function	Type	ANSI No.	Function Description
	10XG16	Classroom Security, Apartment, Exit, Privacy	F88	<ul style="list-style-type: none"> Deadlocking latch Latch by either lever unless outside lever is locked by key in inside lever Key in outside lever retracts latch when outside lever is locked Inside lever always operative Key turn indicator standard with this function, see page 10
	10XG17	Utility, Asylum or Institutional	F87	<ul style="list-style-type: none"> Deadlocking latch Both levers locked at all times Latch by key either side Use only on rooms with more than one exit
	10XG26	Store or Storeroom	F91	<ul style="list-style-type: none"> Deadlocking latch Latch by either lever Key in either lever locks or unlocks both levers
	10XG30	Communicating	F80	<ul style="list-style-type: none"> Deadlocking latch Latch by either lever Key in either lever locks or unlocks its own lever only Use only on rooms with more than one exit
	10XG38	Classroom Security Intruder	F110	<ul style="list-style-type: none"> Deadlocking latch Latch by either lever unless outside lever is locked by key Key in either lever locks or unlocks outside lever Inside lever always operable Key turn indicator standard with this function, see page 10

Copyright © 2021-2025, Sargent Manufacturing Company, an ASSA ABLOY Group company. All rights reserved. Reproduction in whole or in part without the express written permission of Sargent Manufacturing Company is prohibited.

-  Shaded lever indicates it is rigid/locked at all times.
-  Freewheeling locking levers available on all locking functions, specify FW- Option.
-  Indicates function available with BHW trim.
-  Indicates function available with VSL trim.
-  Indicates function available with RPB option.

Functions

10X Line Cylindrical Lever Locks

Non-Cylinder Functions

Inside/Outside	Series/ Function	Type	ANSI No.	Function Description
	10XG13	Exit	F89	<ul style="list-style-type: none"> Deadlocking latch Latch by inside lever Outside lever locked at all times
	10XG14	Patio or Privacy	F77A	<ul style="list-style-type: none"> Deadlocking latch Latch by either lever unless outside lever is locked by push button in inside lever Turning inside lever or closing door releases button Should not be used in rooms that have no other entrance
	10XU15	Passage	F75	<ul style="list-style-type: none"> Latch by either lever
	10XG15-3	Exit or Communicating	—	<ul style="list-style-type: none"> Deadlocking latch Blank rose outside Latch by lever inside Minimum clearance of 1-1/8" on single doors and 2-1/4" between double doors
	10XG64	Time Out Lock	—	<ul style="list-style-type: none"> Deadlocking latch Latch by either lever either side (passage) unless push button depressed and held by caretaker (detention side becomes rigid). Lock returns to passage mode upon release of push button. Push button automatically releases when caretaker releases push button. Both levers always free
	10XU65	Privacy/ Bathroom	F76A	<ul style="list-style-type: none"> Latch by either lever unless outside lever is locked by push button in inside lever Turning inside lever or closing door releases button Emergency cointurn in outside lever releases inside button
	10XU66	Privacy/ Bathroom	F76A	<ul style="list-style-type: none"> Latch by either lever unless outside lever is locked by push button in inside lever Turning inside lever or closing door releases button Emergency release tool (provided) in outside lever releases inside button
	10XU68	Hospital Privacy	—	<ul style="list-style-type: none"> Latch by either lever unless outside lever is locked by push button in inside lever Turning inside lever or closing door releases button Rotating thumbturn in outside lever unlocks the outside lever and releases the inside button
	10XU93	Single Lever Pull	—	<ul style="list-style-type: none"> Lever acts as a pull only, no operation Lever is rigid Requires special door preparation, see template A8294
	10XU94	Double Lever Pull	—	<ul style="list-style-type: none"> Lever and rose both sides joined by two through-bolts Levers act as a pulls only, no operation Levers are rigid Requires special door preparation, see template A8294
	10XU94-2	Double Lever Pull	—	<ul style="list-style-type: none"> For wood or custom hollow metal doors Lever and rose both sides joined by two through-bolts Dummy latch plate Uses standard door prep template

- Shaded lever indicates it is rigid/locked at all times.
- Freewheeling locking levers available on all locking functions, specify FW- Option.
- Indicates function available with BHW trim.
- Indicates function available with VSL trim.
- Indicates function available with RPB option.

Technical Details

10X Line Electrified Lock

SARGENT
ASSA ABLOY

The 10X Line electrified lock provides remote locking and unlocking, utilizing the 10X Line cylindrical lock. It is ideal for door control where increased security is necessary at all times, while meeting life safety codes.



Featuring EcoFlex®



- Reduces energy consumption up to 92%, as certified by GreenCircle
 - Lower operating costs
 - Assists with load reduction in optimizing energy performance credit in LEED
 - Reduces number of power supplies required
- Field configurable to fail-safe or fail-secure
- Operates from 12-24VDC, offering greater flexibility in system design
- Innovative actuator design provides superior reliability
 - Higher performance and reduced maintenance
 - Ability to have longer cable runs without negatively impacting lock function
 - Reduces risk of voltage drops and eliminates inductive kickback
 - Lower total cost of ownership

Door Prep	ANSI/SDI A250.14
Door Thickness	1-3/4" (44mm) thick door adjusts to 2" (51mm) standard 1-3/8" (35mm) thick door, specify 1- Option for Adapter plates Over 2" (51mm) up to 2-1/4" (57mm), specify 31- Option
Minimum Stile	4-1/2" (114mm)
Handing	Non-handed
Backset	2-3/4" (70mm) backset w/ 1-1/8" (29mm) front (standard) 2-3/8" (60mm) backset w/ 1" (25mm) wide front (specify 20- Option) 3-3/4" (95mm) backset w/ 1-1/8" (29mm) front (specify 23- Option) 5" (127mm) backset w/ 1-1/8" (29mm) front (specify 25- Option)
Latchbolt	Stainless steel, 1/2" (13mm) throw Optional: Brass 3/4" (19mm) throw deadlocking fire latch for pair of doors (specify 41- Option)
Front	Wrought brass and stainless steel 2-1/4" x 1-1-8" (57mm x 29mm) 2-1/4" x 1" (57mm x 25mm)
Strike	Wrought brass, bronze and stainless steel 808 curved lip ANSI 4-7/8" strike - standard 800 curved lip strike (specify 29- Option) Wrought box strike available (specify WBS- Option)
Cylinder	Brass, 6-pin LA keyway, 1-bitted standard, specify KD for keyed different/random
Keys	Two nickel silver change keys per lock standard
Masterkeying	Can be master keyed or grand master keyed Construction key systems available
Voltage	Accommodates 12VDC or 24VDC (Operating range 10.2VDC to 26.4VDC). Lock is polarity sensitive.
Electrical Specifications	Fail Safe / Fail Secure Current draw: 10mA @ 12VDC or 24VDC Continuous Peak current draw: 500mA @ 12VDC or 24VDC (Maximum of 2 locks per 1A Power Supply) Monitor switch rating: 500mA Max to 24VDC
Electrical Options	Request to Exit switch for monitoring activation of the inside lever (specify RX- Option)
Operating Temperature	-13°F (-25°C) to 151°F (66°C)
Operating Humidity	5% to 95% relative humidity non condensing
ElectroLynx®	Provided with 8-pin molex connector
Finishes	See page 23
Warranty	Two-year limited

Functions

Inside	Outside	Series/Function	Function Description
		10XG70	Fail Safe <ul style="list-style-type: none"> • Deadlocking latch by lever either side except when power on locks outside lever • Power off/unlocks outside lever • Inside lever always free • Latchbolt retracted by key when locked electrically
		10XG71	Fail Secure <ul style="list-style-type: none"> • Deadlocking latch by lever either side except when power off locks outside lever • Power on/unlocks outside lever • Inside lever always free • Latchbolt retracted by key when power is off

Indicates function available with BHW trim.

Electrical Accessories

10X Line Cylindrical Lever Locks

Requirements for Electrical and Data Transfer

To answer the demand for “smart” electronic access control and locking solutions that require fast, easy, and cost-effective installation, ASSA ABLOY Group brands use the ElectroLynx® standardized plug-in connectors and color-coded wiring system.

With ElectroLynx, doorway components come pre-wired for easy hookup to the power source. Key to the system is the transfer device hinge that carries power from the frame to the locking hardware.

Features of ElectroLynx®:

- Makes it easy to bring power to the locking hardware
- Wires have connectors that snap together, like plugging a telephone into a jack

To connect 10X Line Electrified Lock to the electronic access control system, the following items are required:

- 10X Line Electrified Lock
- ASSA ABLOY Door Group pre-wired door, or ElectroLynx® retrofit cable (order from McKinney)
- Electronic transfer device (ElectroLynx® electronic transfer hinge or Electrical Power Transfer with standard hinge, from McKinney)
- ElectroLynx® cable from the hinge to above the ceiling (order from McKinney)

Information regarding cable selection, hinge requirements and order strings can be found in the McKinney Transfer Device Solutions catalog. Consult 800-810-WIRE (9473) with questions on application specifications and requirements.

McKinney QC8 ElectroLynx® hinges are recommended for Electrified 10X Line Applications.

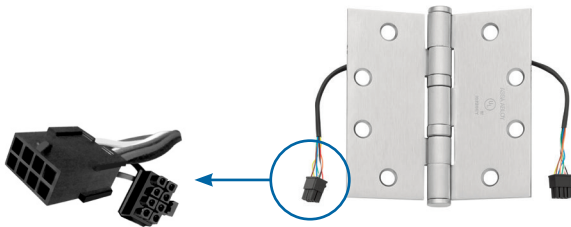

LSP-12-24 Power Supply

Operation

LifeSafety Power supplies are designed to provide reliable filtered and regulated power for long life to a variety of electrified hardware components.

Features

- Selectable voltage output between 12V and 24V with a single switch
- Internal Back-Up battery charging circuit *
- Regulated and filtered, fuse protected outputs
- Each output can be individually turned on and off via a jumper
- Power status of each output is shown by an LED
- Rugged steel enclosure
- Fire alarm interface included – Dry contacts NO/NC, 9-33VDC, 3-15mA

Electrical Specifications

- Inputs: 120VAC
- Outputs: 12VDC @ 6 Amp or 24VDC @3 Amp
– 8 Total Outputs

Listings

- UL294, UL603, UL1076
- ULC S318, ULC S319

Applications

- Fail safe cylindrical locks
- Fail secure cylindrical locks

* Note: Batteries are not included with the power supply

Model No.	Description
LSP-12-24	12V – 6AMP / 24V – 3AMP Power Supply



Cylinders

10X Line Cylindrical Lever Locks

Cylinders are supplied 1-bitted unless specified keyed random or master keyed. For master keyed orders provide keying details as requested on SARGENT Keyed Order Lead Sheets, located in the price book or contact customer service.

Fixed Core

Description	Pins	Door Thickness	Used with Mechanical Functions	Used with Electrified Functions
Conventional	6	1-3/8" - 2"	C10X-1	C10X-1E
		2-1/4"	31-C10X-1	31-C10X-1E
Hotel	6	1-3/8" - 2-1/4"	C10X-2	N/A
Signature	6	1-3/8" - 2"	10-C10X-1	10-C10X-1E
		2-1/4"	10-31-C10X-1	10-31-C10X-1E
XC	6	1-3/8" - 2"	11-C10X-1	11-C10X-1E
		2-1/4"	11-31-C10X-1	11-31-C10X-1E
Keso	6	1-3/8" - 2"	F1-82-C10X-1	F1-82-C10X-1E
		2-1/4"	F1-82-31-C10X-1	F1-82-31-C10X-1E
Degree® - Patented (DG1)	6	1-3/8" - 2"	DG1-C10X-1	DG1-C10X-1E
		2-1/4"	DG1-31-C10X-1	DG1-31-C10X-1E
Degree® - Patented Hotel (DG1)	6	1-3/8" - 2-1/4"	DG1-C10X-2	N/A
Degree® - Security (DG2)	6	1-3/8" - 2"	DG2-C10X-1	DG2-C10X-1E
		2-1/4"	DG2-31-C10X-1	DG2-31-C10X-1E
Degree® - Security Hotel (DG2)	6	1-3/8" - 2-1/4"	N/A	N/A
Degree® - High Security (DG3)	6	1-3/8" - 2"	DG3-C10X-1	DG3-C10X-1E
		2-1/4"	DG3-31-C10X-1	DG3-31-C10X-1E
Degree® - High Security Hotel (DG3)	6	1-3/8" - 2-1/4"	N/A	N/A

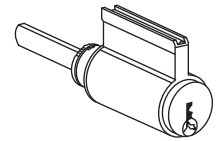

C10X-1

- Cylinders are brass and come with 2 nickel silver keys.
- Finishes: 04, 15 or BSP.
- To order cylinders separately, specify Model No. x Keyway x Finish (e.g., C10X-1 x LA x 15).
- Refer to 10X Line Parts Manual for tailpiece information.

Large Format Interchangeable Core[^]

Description	Pins	Used with All Functions
Conventional	6	6300
Hotel	6	N/A
Signature	6	10-6300
XC	6	11-6300
Keso	6	N/A
Degree® - Patented (DG1)	6	DG1-6300
Degree® - Security (DG2)	6	DG2-6300
Degree® - High Security (DG3)	6	DG3-6300
Degree® - Hotel Patented (DG1)	6	N/A
Degree® - Hotel Security (DG2)	6	N/A
Degree® - Hotel High Security (DG3)	6	N/A

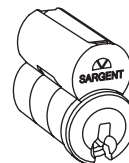

DG-6300

- Cores are brass and come with 2 nickel silver keys.
- Finishes: 04, 15 or BSP.
- To order cores separately, specify Model No. x Keyway x Finish (e.g., 6300 x LA x 15).
- Refer to 10X Line Parts Manual for tailpiece information.

[^] Locks will be provided with the applicable tailpiece per the type interchangeable and/or removable core being used. For example standard cores and XC cores require different tailpieces. When ordering complete locks, the appropriate option code must be specified in accordance to the permanent core being used. See pages 20-21 for cylinder options.

Cylinders

10X Line Cylindrical Lever Locks

Small Format Interchangeable Core[^]

Description	Pins	Used with All Functions
Conventional	6	7300B
	7	7P-7300B
XC	6	11-7P-7300B

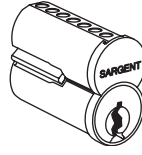

7P-7300B

- Cores are brass and come with 2 nickel silver keys.
- Finishes: 04 or 15.
- Refer to 10X Line Parts Manual for tailpiece information.

[^] Locks will be provided with the applicable tailpiece per the type interchangeable and/or removable core being used. For example standard cores and XC cores require different tailpieces. When ordering complete locks, the appropriate option code must be specified in accordance to the permanent core being used. See pages 20-21 for cylinder options.

Cylinders with Competitive Keyways

Description	Pins	Door Thickness	Used with Mechanical Functions	Used with Electrified Functions
Schlage® C (0-bitted)	6	1-3/8" - 2"	SC-C10X-1	SC-C10X-1E
		2-1/4"	SC-31-C10X-1	SC-31-C10X-1E
Schlage® E (0-bitted)	6	1-3/8" - 2"	SE-C10X-1	SE-C10X-1E
		2-1/4"	SE-31-C10X-1	SE-31-C10X-1E

- Cylinders are brass and come with 2 nickel silver key blanks.
- Finishes: 04 or 15.

Levers That Accept Competitive Interchangeable Core Cylinders*

Cylinder Type	Option Code
SFIC 6 or 7-pin (all designs)	70- Tailpiece included
Schlage® 6-pin LFIC (L, B, P, BHW or VSLL only)	SF- Tailpiece included
ASSA ABLOY ACCENTRA™ 6-pin LFIC 1210, 5210, K800-6 (L, P or VSLL only)	YRC Tailpiece included

Levers That Accept Competitive Fixed Core Cylinders*

Competitive Cylinder	Option Code
Schlage® 6-pin fixed core 20-548, 20-550, 20-748, 20-750, 21-002, 23-001, 23-013	30- Tailpiece and special lever included
Corbin Russwin 6-pin fixed core CR2000, CR2010, CR2020, CR2027, CR2500, CR2600, CR2700	YC- Tailpiece and special lever included
Corbin Russwin 7-pin fixed core CR2000-7	YC-7P- Tailpiece and special lever included
ASSA ABLOY ACCENTRA™ 6-pin fixed core 1803, 5803, K403	YC- Tailpiece and special lever included
ASSA ABLOY ACCENTRA™ 7-pin fixed core 1803A, 5803A, K403A	YC-7P- Tailpiece and special lever included

*Cylinder not included.

Refer to 10X Line Series Parts Manual for tailpiece information.

Latches

10X Line Cylindrical Lever Locks

Latches

- Finishes: 03, 04, 09, 10, 10B, 10BE, 10BL, 20D, 32D, BSP, WSP

Plain/Unguarded Latch - 10XU15, 10XU65, 10XU68:

Part No.	Front	Front Width	Backset	Throw
10-3187	Square Corner	1" (25mm)	2-3/8" (60mm)	1/2" (13mm)
10-2022	Square Corner	1-1/8" (29mm)	2-3/4" (70mm)	1/2" (13mm)
10-2054	Square Corner	1-1/8" (29mm)	3-3/4" (95mm)	1/2" (13mm)
10-2057	Square Corner	1-1/8" (29mm)	5" (127mm)	1/2" (13mm)

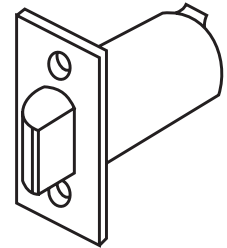

Plain/Unguarded

Deadlocking/Guarded Latch - All Other Mechanical Functions:

Part No.	Front	Front Width	Backset	Throw
10-3186	Square Corner	1" (25mm)	2-3/8" (60mm)	1/2" (13mm)
10-3192	Square Corner	1-1/8" (29mm)	2-3/4" (70mm)	1/2" (13mm)
10-2053	Square Corner	1-1/8" (29mm)	3-3/4" (95mm)	1/2" (13mm)
10-2058	Square Corner	1-1/8" (29mm)	5" (127mm)	1/2" (13mm)
10-2634*	Square Corner	1-1/8" (29mm)	2-3/4" (70mm)	3/4" (19mm)

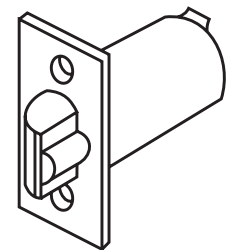

Deadlocking/Guarded

* 04/26D finish only

Deadlocking/Guarded Latch - Electrified Functions:

Part No.	Front	Front Width	Backset	Throw
10-3433	Square Corner	1" (25mm)	2-3/8" (60mm)	1/2" (13mm)
10-3430	Square Corner	1-1/8" (29mm)	2-3/4" (70mm)	1/2" (13mm)
10-3431	Square Corner	1-1/8" (29mm)	3-3/4" (95mm)	1/2" (13mm)
10-3432	Square Corner	1-1/8" (29mm)	5" (127mm)	1/2" (13mm)

Miscellaneous:

Part No.	Description
10-2059	3-3/4" (95mm) Latch extension with sleeve
10-2060	5" (127mm) Latch extension with sleeve

When ordering latches separately, specify Part No. x Finish (e.g., 10-3186 x 32D)

Strikes and Miscellaneous Parts

10X Line Cylindrical Lever Locks

Strikes

- Finishes: 03, 04, 09, 10, 10B, 10BE, 10BL, 20D, 32, 32D, BSP, WSP

4-7/8" Curved Lip Strike (Standard)

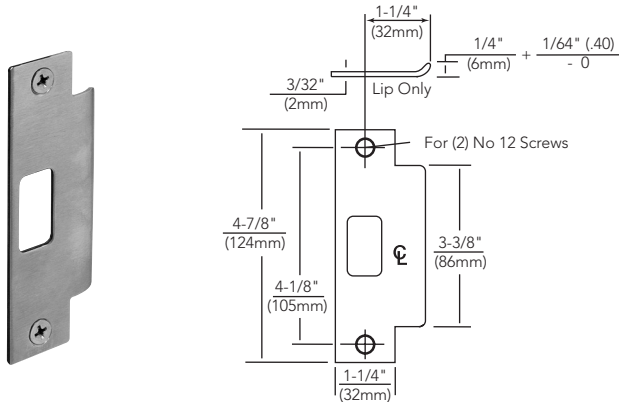

- Brass, bronze or stainless steel
- Conforms to ANSI standard
- Furnished standard with curved lip 1-1/4" (32mm) from center of strike screw holes to end of lip
- Lip lengths: 7/8" (22mm), 1-1/8" (29mm), 1-1/4" (32mm), 1-3/8" (35mm), 1-5/8" (42mm), 1-7/8" (48mm), 2-1/8" (54mm), 2-3/8" (60mm), 2-5/8" (66mm), 2-7/8" (73mm) and 3" (76mm)
- 77-1141 Wrought strike box available separately
- To order strike separately, specify 808 strike x finish x lip length

ANSI Wrought Strike Box

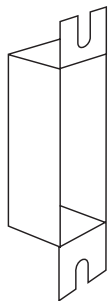

- Used with ANSI 4-7/8" (124mm) strike (#808)
- To order with lock, specify option WBS
- To order separately, specify 77-1141

2-3/4" Curved Lip Strike (29- Option)

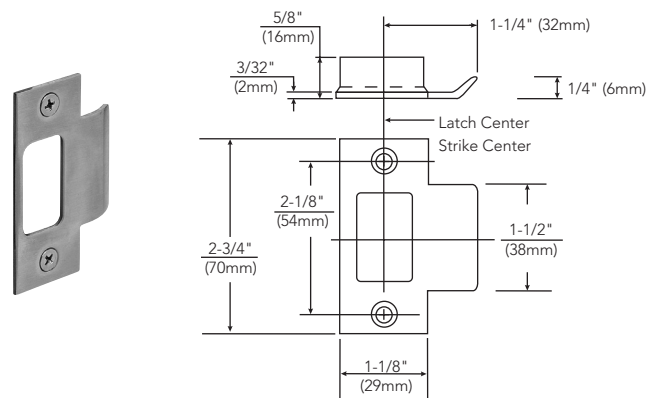

- Brass, bronze or stainless steel
- Furnished standard with 1-1/4" (32mm) curved lip from center of strike screw holes to end of lip
- Lip lengths 1" (25mm), 1-1/4" (32mm) standard, 1-1/2" (38mm), 1-3/4" (44mm), 2" (51mm) and 3" (76mm)
- Plastic strike box AM-0044 included when 29- ordered with lockset
- To order strike separately, specify 800 strike x finish x lip length

Miscellaneous Parts

Part No.	Description
10-3188	1-3/8" Adapter plate pack (set of 2)
C10X-3	Emergency release cylinder (65 function) 1-3/8"-2" door
31-C10X-3	Emergency release cylinder (65 function) 2-1/4" door
10-0043	Push pin tool
10-1224	Screw pack (standard)
10-1250	Screw pack (29- option)
10-1504	Plastic door prep tool (through-bolts at 12 & 6 o'clock with 2-3/4" center to center)
82-3855	6 Lobe Torx® Bit Pack (36-) (sizes- T8, T9, T10, T15, T20, T25, T27) 7/16" Driver
82-3856	Spanner Bit Pack (37-) (sizes- 4, 6, 8, 10, 12, 1/4") 1/4" Driver

Refer to 10X Line Parts Manual for additional parts information.

Cylinder Options

10X Line Cylindrical Lever Locks

Cylinder Options:

Conventional Cylinder	—	SARGENT® conventional cylinders supplied standard (nomenclature not required)
Degree Key System	DG1-	SARGENT Degree key system level 1 (bump resistant with patented keys)
	DG1-21-*	Degree level 1 construction master keying
	DG1-60-*	Degree level 1 removable disposable construction core
	DG1-63-*	Degree level 1 removable core
	DG1-64-*	Degree level 1 removable construction keyed LFIC
	DG1-65-*	Degree level 1 unassembled/uncombined fixed core component cylinder (packed loose for field keying)
	DG1-63-65-*	Degree level 1 unassembled/uncombined removable core LFIC (packed loose for field keying)
	DG2- *	SARGENT Degree key system level 2 (geographically exclusive; bump and pick resistant)
	DG2-21- *	Degree level 2 construction master keying
	DG2-60-*	Degree level 2 removable disposable construction core
	DG2-63-*	Degree level 2 removable core
	DG2-64-*	Degree level 2 removable construction keyed LFIC
	DG2-65-*	Degree level 2 unassembled/uncombined fixed core component cylinder (packed loose for field keying)
	DG2-63-65-*	Degree level 2 unassembled/uncombined removable core LFIC (packed loose for field keying)
	DG3-*	SARGENT Degree key system level 3 (geographically exclusive; UL437 certified; bump and pick resistant)
	DG3-21- *	Degree level 3 construction master keying
	DG3-60-*	Degree level 3 removable disposable construction core
	DG3-63-*	Degree level 3 removable core
DG3-64-*	Degree level 3 removable construction keyed LFIC	
Signature Key System	10-*	SARGENT Signature key system
	10-21-*	SARGENT Signature construction key system (lost ball)
Signature: Large Format Interchangeable Core (Removable Core)	10-63-*	SARGENT Signature LFIC (removable core) cylinder
XC- Key System	11-*	XC Key System
	11-21-*	XC- Construction Key System (Lost Ball)
XC- Large Format Interchangeable Core (Removable Core)	11-60-*	Lock to accept XC-LFIC (removable core) and provided with disposable plastic core; XC-LFIC permanent core ordered separately
	11-63-*	Lock provided with XC-LFIC (removable core); Includes master keying, grand master keying
	11-64-*	Lock to accept XC-LFIC (removable core) and provided with keyed construction core; XC-LFIC permanent core ordered separately.
XC- Small Format Interchangeable Cores	11-70-7P-*	Lock to accept XC-SFIC (7-pin, removable core) and provided with disposable plastic core; XC-SFIC permanent core ordered separately
	11-72-7P-*	Lock to accept XC-SFIC (7-pin, removable core) and provided with keyed construction core; XC-SFIC permanent core ordered separately
	11-73-7P-*	Lock provided with XC-SFIC (7-pin, removable core); Includes master keying, grand master keying
	11-65-73-7P-*	Lock provided with uncombined SFIC (7-pin, removable core); Packed loose
Construction Key System	21-*	SARGENT Lost Ball Construction Keying for Conventional, XC and Signature Series (N/A with 63- or 73-)

Note: Cylinder Options continued on the following page

* Options not available with 10XG50

Cylinder Options

10X Line Cylindrical Lever Locks

Cylinder Options:

Large Format Interchangeable Core (Removable Core)	60-*	Lock to accept LFIC (removable core) and provided with disposable plastic core; LFIC permanent core ordered separately
	63-*	Lock provided with LFIC (Removable Core) Cylinder — (Includes masterkeying, grand masterkeying)
	64-*	Lock to accept LFIC (removable core) and provided with keyed construction core; LFIC permanent core ordered separately
Small Format Interchangeable Cores	70-*	Lock to accept SFIC (6 or 7-pin, removable core) and provided with disposable plastic core; SFIC permanent core ordered separately
	72-*	Lock to accept SFIC (6 or 7-pin, removable core) and provided with keyed construction core; SFIC permanent core ordered separately
	73-*	Lock provided with SFIC (6-pin, removable core); Includes master keying, grand master keying
	73-7P-*	Lock provided with SFIC (7-pin, removable core); Includes master keying, grand master keying
	65-73-*	Lock provided with uncombined SFIC (6-pin, removable core); Packed loose
	65-73-7P-*	Lock provided with uncombined SFIC (7-pin, removable core); Packed loose
Keso & Keso F1	80-^	Lock to accept Keso and Keso F1 cylinders — no cylinders provided (L,B,P levers only)
	82-^	Lock provided with SARGENT Keso Security Cylinder (L,B,P levers only)
	F1-82-^	Lock provided with SARGENT Keso F1 Security Cylinder (Patented) (L,B,P levers only)
Bump Resistant	BR-	Bump Resistant Cylinder (available with Conventional & Conventional XC Cylinders only)
Keyed Different	KD-	Cylinders provided keyed differently/random
Less Cylinder	LC-	Lock supplied less cylinder, tailpiece provided
Schlage® Keyways	SC-*	Schlage® C keyway cylinder, 0 bitted
	SE-*	Schlage® E keyway cylinder, 0 bitted
Accepts Schlage® Cylinders	30-*	Lever to accept Schlage® fixed core cylinder - cylinder is not provided (all designs)
	SF-*	L, B, P, BHW or VSLL lever to accept Schlage® large format interchangeable core (supplied less core, tailpiece provided)
Accepts ASSA ABLOY ACCENTRA™ Cylinders/Cores	YC-	Lever to accept Corbin Russwin or ASSA ABLOY ACCENTRA™ 6-pin fixed core cylinder - less cylinder, tailpiece provided (all designs)
	YC-7P-	Lever to accept Corbin Russwin or ASSA ABLOY ACCENTRA™ 7-pin fixed core cylinder - less cylinder, tailpiece provided (all designs)
	YRC-^	L, P or VSLL Lever to accept ASSA ABLOY ACCENTRA™ 6-pin large format interchangeable core (supplied less core, tailpiece provided)

* Options not available with 10XG50

^Not available with BHW trim

Note:

- 10X Line locks will be provided with the applicable tailpiece per the type of interchangeable and/or removable core being used. For example standard cores and XC cores require different tailpieces. Appropriate option codes must be specified in accordance to the permanent core being used.

Mechanical Options

10X Line Cylindrical Lever Locks

Mechanical Options:

Thin Doors	1-^	Adapter plates for 1-3/8" thick doors (2-3/4" backset latch with 1-1/8" front provided unless 20- option for 2-3/8" backset also specified)
Backset Options	20-^	2-3/8" backset latch with 1" front
	23-	3-3/4" backset x 2-1/4" x 1-1/8" front
	25-	5" backset x 2-1/4" x 1-1/8" front
Strike	29-	Strike #800. Lip length 1-1/4". Lip lengths 1" to 2" in 1/4" increments only.
Thick Doors	31-^	For 2" to 2-1/4" thick doors, centered in door prep, no paneling. When specifying 31-, door thickness must be provided. Consult factory for other door thicknesses available by special application.
Security Fasteners	36-	6-Lobe security head Torx® screws (standard for BHW trim)
	37-^	Spanner head screws
3/4" Throw	41-^	3/4" throw latchbolt x 2-3/4" backset
Lead Lining	74-	Lead provided between lockbody and spring cartridge
Tactile Warning Options	75-	Tactile warning - handicap warning milled on backside of inside lever (L, B, P levers only)
	76-	Tactile warning - handicap warning milled on backside of outside lever (L, B, P levers only)
	77-	Tactile warning - handicap warning milled on backside of both levers (L, B, P levers only)
	85-^	Tactile warning - abrasive coating finish on inside lever (not available for VSLL)
	86-^	Tactile warning - abrasive coating finish on outside lever (not available for VSLL)
Outside Locked Levers	87-^	Tactile warning - abrasive coating finish on both levers (not available for VSLL)
	FW-	Freewheeling locking levers
Finish Protection	RGD-	Rigid locking levers
	SG-	MicroShield® antimicrobial clear powder coat (only available with 26D and 32D finishes)
Visual Status Indicators	CPC-	Clear Powder Coat over 26D – 10XG05 x LL x 26D x CPC
	RPB-	Push/turn button provided with red powder coat finish (available with functions: 05, 14, 24, 44, 50, 53, 54, 65, 66, 68)
	V30	Indicator Outside Only with Icons - Green/Red
	V60	Indicator Outside Only with Icons - White/Red
	V03	Indicator Inside Only with Icons - Green/Red
	V06	Indicator Inside Only with Icons - White/Red
	V33	Indicator Both Sides with Icons - Green/Red
V66	Indicator Both Sides with Icons - White/Red	
Request to Exit	RX-	Request to exit - monitors inside lever rotation (available with functions: 04, 05, 15, 37, 70 & 71)
Box Strike	WBS-	Wrought box strike

^Not available with BHW trim

Finishes, Packaging

10X Line Cylindrical Lever Locks

SARGENT #	Descriptions	ANSI/BHMA
03	Polished brass, clear coated	605
04	Satin brass, clear coated	606
09	Polished bronze, clear coated	611
10	Satin bronze, clear coated	612
10B	Oxidized bronze, oil rubbed	613
10BE	Dark oxidized satin bronze - equivalent	613E
10BL	Oxidized satin, bronze, clear coated	613L
14	Polished nickel, clear coated	618
15	Satin nickel, clear coated	619
20D	Statuary dark bronze, clear coated	624
26	Polished chrome	625
26D	Satin chrome	626
32D	Satin stainless steel (BHW only)	630
BSP	Black suede powder coat	BSP
WSP	White suede powder coat	WSP
SG- Option	MicroShield® antimicrobial clear powder coat (only available with 26D or 32D finishes)	
Zinc levers are plated to match ANSI/BHMA finish. Custom colors available, consult factory. Split finishes: - Specify outside finish first i.e. 10XG05 x LL x 26D x 03 x RH - Handing must be specified - Strike and latch front will match the following: RH & LH = inside finish RHR & LHR = outside finish		

Lock Finish	Cylinder/Core*
03, 04, 09, 10, 10B, 10BE, 10BL, 20D	04
14, 15, 26, 26D, 32D, WSP	15
BSP	BSP

*Finish when cylinder provided with lock. 15 finish provided for cylinders/cores where BSP not available, see cylinder pages 16-17 for finish availability.

Packaging

10XG05 x LL	10XG04 x BHW
4.8 lbs/box (2.2 kg/box)	14.6 lbs/box (6.6 kg/box)
8 boxes/case	1 boxes/case

How to Order

10X Line Cylindrical Lever Locks

How to Order

5	DG1-	10XG05	G	MD	RH	15	AA1
2	RX-DG1-	10XG71	G	MD	RH	15	AA2
3	FW-	10XU65	—	BHW	RH	15	—
Quantity	Options*	Lock & Function	Rose	Lever	Hand	Finish	Additional Information
	Available Options Pg 17-19	Available Functions Pg 8-11	Available Roses G & L	Available Levers Pg 6	RH, LH, RHR, LHR	Available Finishes Pg 20	Such as Item, Heading Number, Door Number, Cylinder Keying Details (i.e KD, Keyset)

* Multiple options may be selected
For Indicator Trim, see page 9

How to Specify Handing

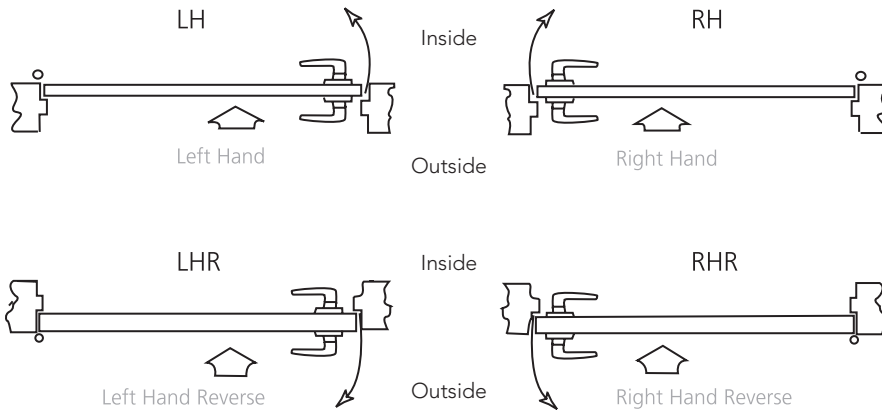

Copyright © 2021-2025, Sargent Manufacturing Company, an ASSA ABLOY Group company. All rights reserved. Reproduction in whole or in part without the express written permission of Sargent Manufacturing Company is prohibited.

Suggested Architectural Specifications

- A. Locks shall be 10X Line as manufactured by Sargent Manufacturing Company, New Haven, CT.
- B. Locks shall be ANSI/BHMA Certified Products Directory (CPD) listed.
 - 1. A156.2, Series 4000, Grade 1
 - 2. A156.41
- C. Locks shall exceed the requirements of ANSI/BHMA A156.2 Series 4000, Grade 1 with all standard trims, as follows:
 - 1. Cycle Test: Exceeds ANSI/BHMA A156.2 Grade 1 requirements with no lever sag. Verified by UL for Operational Cycling (V584148) at 20 Million Cycles.
 - 2. Abusive Locked Lever Torque: Exceeds 3,100 in-lb with no entry while maintaining egress (2.6 times ANSI/BHMA A156.2 requirements)
 - 3. Offset Lever Pull: Exceeds 1,600 lbs with no entry (8 times ANSI/BHMA A156.2 requirements)
 - 4. Latch Retraction with Preload: Exceeds 100lb preload while maintaining ANSI/BHMA requirements for operation in warped doors (2 times ANSI/BHMA A156.2 requirements)
 - 5. Vertical Impact: Exceeds 100 vertical impacts (20 times ANSI/BHMA A156.2 requirements)
- D. Locks shall comply with UL 10C positive pressure requirements.
- E. Locks required for fire doors shall be listed by Underwriters Laboratories for ratings of 3 hours (A label) and less, for doors up to 4'0" (1.2m) x 10'0" (3.0m) and pairs of doors 8'0" (2.4m) x 10'0" (3.0m)
- F. Locks shall have a push/turn button adjustable for door thickness without disassembly.
- G. Locks shall have a chassis design that supports all cylinder formats (except Keso) allowing flexibility for changing from fixed core to interchangeable core cylinders.
- H. Locks shall be non-handed with bi-directional lever operation.
- I. Lock levers shall be made of solid material.
- J. Lock shall be available in a minimum of seven different lever designs.
- K. Locks shall have a 2-3/4" (70mm) standard backset.
- L. Strikes shall be non-handed with a curved lip. Provide wrought boxes with strikes.
- M. Locks shall have brass 6-pin cylinder standard.
 - 1. Provide two nickel silver keys with each lock.
- N. Locks shall have approximately 45 degrees of lever rotation in order to fully retract latch.
- O. Locks shall have a ten-year limited warranty.

Suggested Architectural Specifications

- A. Locks shall be 10X Line as manufactured by Sargent Manufacturing Company, New Haven, CT.
- B. Locks shall be listed for low, medium and high risk areas in the New York State Office of Mental Health (NYS-OMH) Patient Safety Standard.
- C. Locks shall be ANSI/BHMA Certified Products Directory (CPD) listed.
 - 1. A156.2, Series 4000, Grade 1
 - 2. A156.41
- D. Locks shall exceed the requirements of ANSI/BHMA A156.2 Series 4000, Grade 1 with all standard trims.
- E. Locks shall comply with UL 10C positive pressure requirements.
- F. Locks required for fire doors shall be listed by Underwriters Laboratories for ratings of 3 hours (A label) and less, for doors up to 4'0" (1.2m) x 10'0" (3.0m) and pairs of doors 8'0" (2.4m) x 10'0" (3.0m)
- G. Locks shall have a chassis design that supports all cylinder formats (except Keso) allowing flexibility for changing from fixed core to interchangeable core cylinders.
- H. Lock lever and escutcheon shall be made of solid stainless steel material.
- I. Locks shall have a 2-3/4" (70mm) standard backset.
- J. Strikes shall be non-handed with a curved lip. Provide wrought boxes with strikes.
- K. Locks shall be available with lead-lining and antimicrobial coating.
- L. Exposed fasteners shall be provided as Torx® security pin standard.
- M. Locks shall have brass 6-pin cylinder standard.
 - 1. Provide two nickel silver keys with each lock.
- N. Electrified functions shall be provided with EcoFlex® Technology.
- O. Locks shall have a ten-year limited warranty on mechanical components and a two-year limited warranty on electric components.

Suggested Architectural Specifications

- A. Locks shall be 10X Line as manufactured by Sargent Manufacturing Company, New Haven, CT.
- B. Locks shall be ANSI/BHMA Certified Products Directory (CPD) listed.
 - 1. A156.2, Series 4000, Grade 1
 - 2. A156.41
- C. Locks shall exceed the requirements of ANSI/BHMA A156.2 Series 4000, Grade 1.
- D. Locks shall comply with UL 10C positive pressure requirements.
- E. Locks required for fire doors shall be listed by Underwriters Laboratories for ratings of 3 hours (A label) and less, for doors up to 4'0" (1.2m) x 10'0" (3.0m) and pairs of doors 8'0" (2.4m) x 10'0" (3.0m)
- F. Locks shall have a chassis design that supports all cylinder formats (except Keso) allowing flexibility for changing from fixed core to interchangeable core cylinders.
- G. Lock levers shall be made of solid material.
- H. Locks shall have indicator trim which visually displays the lock status of the door.
- I. Visual status indicators shall consist of six (6) individual windows for viewing at all angles.
- J. Visual status trim shall be non-handed and able to install easily on doors with any handing.
- K. Visual status indicators shall be available for the outside only, inside only or both sides of the door.
- L. Visual status indicators shall be available with a variety of non-keyed and keyed functions.
- M. Locks shall have a 2-3/4" (70mm) standard backset.
- N. Strikes shall be non-handed with a curved lip. Provide wrought boxes with strikes.
- O. Locks shall be available with lead-lining and antimicrobial coating.
- P. Locks shall have brass 6-pin cylinder standard.
 - 1. Provide two nickel silver keys with each lock.
- Q. Locks shall have a ten-year limited warranty on mechanical components.

Architectural Specifications

10X Line Cylindrical Lever Locks with EcoFlex® Technology

Suggested Architectural Specifications

- A. Locks shall be 10X Line as manufactured by Sargent Manufacturing Company, New Haven, CT.
- B. Locks shall be ANSI/BHMA Certified Products Directory (CPD) listed.
 - 1. A156.2, Series 4000, Grade 1
 - 2. A156.41
- C. Locks shall exceed the requirements of ANSI/BHMA A156.2 Series 4000, Grade 1 with all standard trim.
- D. Locks shall comply with UL 10C positive pressure requirements.
- E. Locks required for fire doors shall be listed by Underwriters Laboratories for ratings of 3 hours (A label) and less, for doors up to 4'0" (1.2m) x 10'0" (3.0m) and pairs of doors 8'0" (2.4m) x 10'0" (3.0m)
- F. Locks shall be field configurable Fail Safe / Fail Secure by means of a dip switch setting.
- G. Locks shall have an operating voltage range from 10.2VDC to 26.4VDC.
- H. Locks shall have a continuous current draw of 10mA at 12VDC or 24VDC
- I. Locks shall have a chassis design that supports all cylinder formats allowing flexibility for changing from fixed core to interchangeable core cylinders.
- J. Locks shall be non-handed with bi-directional lever operation.
- K. Lock levers shall be made of solid material.
- L. Lock shall be available in a minimum of seven different lever designs.
- M. Locks shall have a 2-3/4" (70mm) standard backset.
- N. Strikes shall be non-handed with a curved lip. Provide wrought boxes with strikes.
- O. Locks shall have brass 6-pin cylinder standard.
 - 1. Provide two nickel silver keys with each lock.
- P. Locks shall have approximately 45 degrees of lever rotation in order to fully retract latch.
- Q. Locks shall have a two-year limited warranty on electric components.

Notes

10X Line Cylindrical Lever Locks

The ASSA ABLOY Group is the global leader in access solutions. Every day, we help billions of people experience a more open world.

ASSA ABLOY Opening Solutions leads the development within door openings and products for access solutions in homes, businesses and institutions. Our offering includes doors, frames, door and window hardware, mechanical and smart locks, access control and service.

SARGENT[®]

ASSA ABLOY

SARGENT Manufacturing Company
100 Sargent Drive
New Haven, CT 06511 USA
800-727-5477
www.sargentlock.com

Founded in the early 1800s, SARGENT[®] is a market leader in locksets, cylinders, door closers, exit devices, electro-mechanical products and access control systems for new construction, renovation, and replacement applications. The company's customer base includes commercial construction, institutional, and industrial markets.

Copyright © 2021-2025, Sargent Manufacturing Company, an ASSA ABLOY Group company. All rights reserved. Reproduction in whole or in part without the express written permission of Sargent Manufacturing Company is prohibited. Patent pending and/or patent www.assaabloydss.com/patents.