



# CLX3300 Series Cylindrical Lever Locksets

## Product Catalog

Experience a safer  
and more open world

# Table of Contents

## CLX3300 Series



Overview .....	3
Certifications .....	4
Technical Details - Lever Trim .....	5
Lever Trim .....	6
Behavioral Health - BHSS Trim .....	7
Visual Status Indicators .....	8-10
Functions .....	11-13
Technical Details - CLX33900 Electrified Lock .....	14
Electrical Accessories .....	15
Cylinders .....	16-18
Latches .....	19
Strikes .....	20
Quick Codes .....	21-22
Finishes .....	23
How to Order .....	24
How to Specify .....	25-28

### MicroShield®

ASSA ABLOY Group companies offer MicroShield®, an anti-microbial coating for door hardware. MicroShield uses proven silver ion-based technology from Agion®, a leading provider of antimicrobial solutions, to stem the spread of bacteria and other microbes.

MicroShield® is a trademark of ASSA ABLOY Access and Egress Hardware Group, Inc.

### MicroShield® Coating

- Revolutionary finish coating available on all Corbin Russwin product lines, utilizes a silver-based antimicrobial compound from Agion Technologies
- As an integral part of the finish coating, MicroShield lasts for the life of the hardware
- MicroShield coating permanently suppresses the growth of bacteria, algae, fungus, mold and mildew. It is effective against a broad spectrum of bacteria.
- Non-toxic and completely safe. The Agion antimicrobial compound is EPA and NSF approved and FDA listed for use in medical and food preparation equipment.
- Applications: Anywhere there is need for a clean environment (hospitals, laboratories, schools, medical centers, daycare, food processing etc.)



The Agion antimicrobial is not intended as a substitute for good hygiene. Coated products must still be cleaned to ensure the surfaces will be free of destructive microbes. ASSA ABLOY makes no representations or warranties, express or implied, as to the efficacy of the Agion antimicrobial. A copy of the Agion warranty is available upon request. Agion is a registered trademark of Agion Technologies, Inc., Wakefield, MA, USA.



### WARNING

This product can expose you to lead which is known to the state of California to cause cancer and birth defects or other reproductive harm. For more information go to [www.P65warnings.ca.gov](http://www.P65warnings.ca.gov).

# Overview

## CLX3300 Series

The CLX3300 Series ANSI/BHMA Grade 1 cylindrical lock has the strength to secure high-traffic openings with design options to complement any decor. Manufactured of the highest-quality materials to provide durability, strength, and reliability, it is also available in a vast array of finishes and a variety of decorative levers, so you'll never have to sacrifice style for strength.

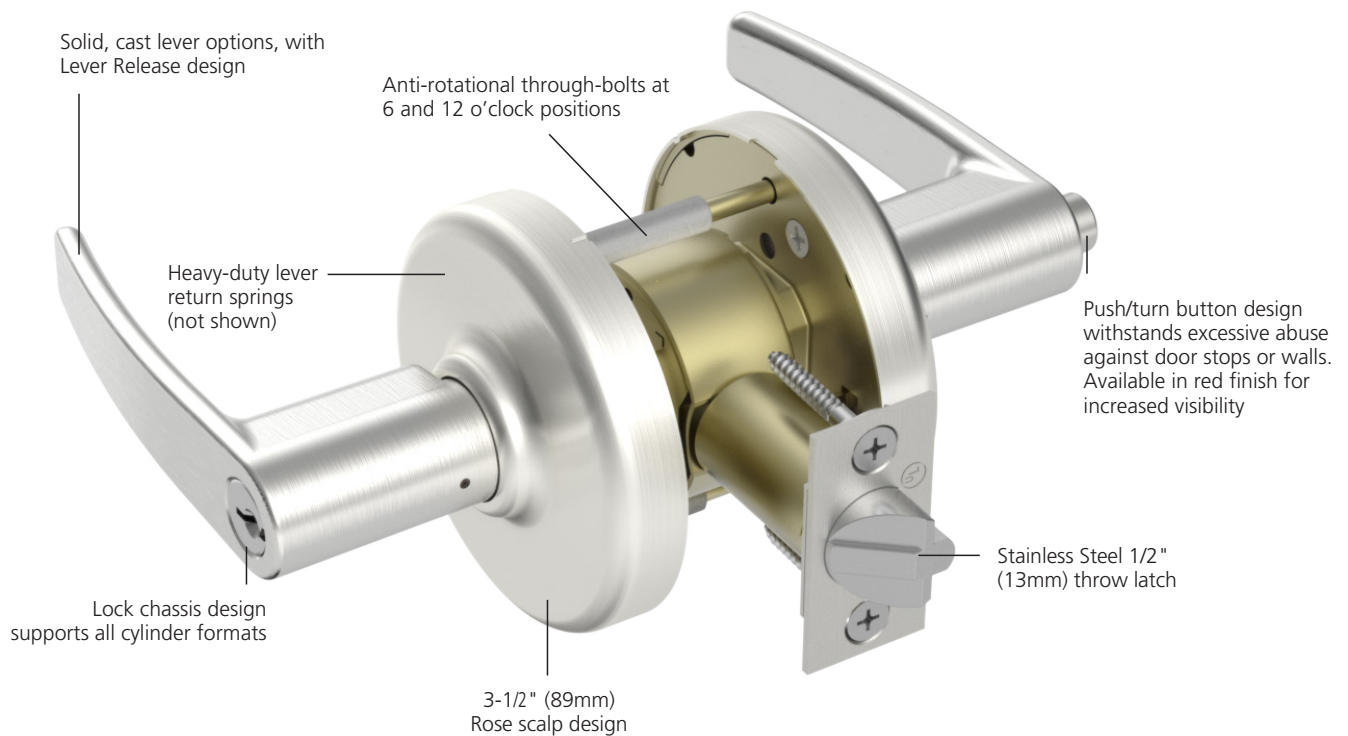

### Applications

- Heavy duty commercial and institutional interior and exterior doors
- Offices
- Schools/Universities
- Hospitals
- Manufacturing facilities



# Certifications

## CLX3300 Series

### Certification/Compliance

ANSI/BHMA	Certified ANSI/BHMA A156.2 (2022) Series 4000 — Grade 1 Certified ANSI/BHMA A156.41
UL/cUL	UL/cUL listed to US and Canadian safety standards for 3 hour doors up to 4' x 10' (double doors require M16 option)
UL294	Listed as an Access Control Accessory (CLX33903 & CLX33905)
NFPA 80	Conforms for life safety and property protection, Standard for Fire Doors and Other Opening Protectives
Positive Pressure	Meets ANSI/UL 10C, Positive Pressure Fire Test of Door Assemblies
ADA	The force required to activate all levers shall be 5 pounds (22.2N) maximum. All levers conform to ADA clear opening width requirements of ANSI A117.1.
California State Reference Code (Formerly Title 19, California State Fire Marshal Standard)	All levers with returns comply; levers return to within 1/2" (13mm) of door face
Windstorm/Hurricane	All individual components of a total door opening are required to comply with each code. Refer to the Corbin Russwin Website ( <a href="http://www.corbinrusswin.com">www.corbinrusswin.com</a> ) for specific code compliance listings for both the lock hardware and other door components.

Any retrofit or other field modification to a fire rated opening can potentially impact the fire rating of the opening, and Corbin Russwin makes no representations or warranties concerning what such impact may be in any specific situation. When retrofitting any portion of an existing fire rated opening, or specifying and installing a new fire-rated opening, please consult with a code specialist or local code official (Authority Having Jurisdiction) to ensure compliance with all applicable codes and ratings.

### Windstorm Certifications: Florida Building Codes & UL Listings

Corbin Russwin products meet building codes that require hurricane and windstorm certifications, including some of the most stringent building codes as specified in the Florida Building Code, Miami Dade Code and the International Building Code. Listed below are certifications and standards met by the CLX3300 Series locks.

#### Florida Building Code: FL3067

#### UL Certification Directory: ZHEM.R21836 – Latching Hardware

ANSI/SDI A250.13 (2014)	"Testing and Rating of Severe Windstorm Resistant Components for Swinging Door Assemblies"
ASTM E330 (2002)	"Standard Test Method for Structural Performance of Exterior Windows, Doors, Skylights and Curtain Walls by Uniform Static Air Pressure Difference" *
ASTM E1886 (2005)	"Standard Test Method for Performance of Exterior Windows, Curtain Walls, Doors, and Impact Protective Systems Impacted by Missile(s) and Exposed to Cyclic Pressure Differentials" *
ASTM E1996 (2009)	"Standard Specification for Performance of Exterior Windows, Curtain Walls, Doors and Impact Protective Systems Impacted by Windborne Debris in Hurricanes" *
(TAS) 201 (1994)	"Impact Test Procedures" *
(TAS) 202 (1994)	"Standard Test Method for Structural Performance of Exterior Windows, Doors, Skylights and Curtain Walls by Uniform Static Air Pressure Difference" *
(TAS) 203 (1994)	"Criteria for Testing Products Subject to Cyclic Wind Pressure Loading" *

\* Published in the 7th Edition (2020), "Florida Building Code" (FBC), State Product Approval Number FL3067

# Technical Details

## CLX3300 Series

<b>Door Prep</b>	ANSI/SDI A250.14
<b>Door Thickness</b>	1-3/4" - 2" (44mm - 51mm) standard 1-3/8" (35mm) thick door, specify Quick Code D138 for Adapter plates Over 2" (51mm) up to 2-1/4" (57mm), specify Quick Code D214 Over 2-1/4" (57mm) up to 6" (152mm) available by special application, contact Technical Product Support
<b>Minimum Stile</b>	4-1/2" (114mm)
<b>Handing</b>	Non-handed
<b>Backset</b>	2-3/4" (70mm) backset w/ 1-1/8" (29mm) (front (standard) 2-3/8" (60mm) backset w/ 1" (25mm) wide front (specify Quick Code B238) 3-3/4" (95mm) backset w/ 1-1/8" (29mm) front (specify Quick Code B334) 5" (127mm) backset w/ 1-1/8" (29mm) front (specify Quick Code B500)
<b>Latchbolt</b>	Stainless steel, 1/2" (13mm) throw Optional: Brass, 3/4" (19mm) throw deadlocking fire latch for pair of doors (specify Quick Code M16)
<b>Front</b>	Wrought brass, bronze, or stainless steel Optional: rounded corners (specify Quick Code M13) 2-1/4" x 1-1/8" (57mm x 29mm) standard for 2-3/4" (70mm), 3-3/4" (95mm) and 5" (127mm) backset 2-1/4" x 1" (57mm x 25mm) standard for 2-3/8" (60mm) backset Accommodates flat doors and doors beveled 1/8" in 2" (3mm in 51mm)
<b>Strike</b>	Wrought brass or stainless steel ANSI curved lip standard, 4-7/8" x 1-1/4" x 1-1/4" (124mm x 32mm x 32mm) lip to center Optional strikes, lip lengths and ANSI wrought strike box available; see page 20
<b>Cylinder</b>	Brass, 6-pin L4 keyway, 0-bitted standard, see Quick Codes page 21
<b>Keys</b>	Two nickel silver change keys per lock standard
<b>Masterkeying</b>	Can be master keyed or grand master keyed Construction key systems available
<b>Lead Lining</b>	Lead provided between lockbody and spring housing (specify Quick Code M28)
<b>Tactile Levers</b>	Knurling (etching) or abrasive coating (surface tape) applied to backside of levers (see Quick Codes page 22)
<b>Finishes</b>	See page 23
<b>Behavioral Health</b>	Compatible with BHSS trim (see page 7)
<b>Visual Status Indicators</b>	Compatible with VSL trim (see page 8)
<b>Warranty</b>	Ten-year limited

### Strength & Durability

- UL Cycle above and beyond test completed at 20 Million Cycles. Verification ID: V875753
- Exceeds 3,100 in-lb abusive locked lever torque with no entry while maintaining egress (2.6 times ANSI/BHMA A156.2 requirements)
- Exceeds 1,600 lbs offset lever pull with no entry for protection against attacks (8 times ANSI/BHMA A156.2 requirements)
- Latch retraction with 100lb preload (2 times ANSI/BHMA A156.2) while maintaining ANSI/BHMA requirements for operation in warped doors
- No access with minimum 100 vertical impacts for protection against vandalism attempts (20 times ANSI/BHMA A156.2 requirements)
- Independent return springs allow lock to exceed ANSI/BHMA A156.2 Grade 1 cycle requirements without lever sag
- Innovative push/turn button design to withstand excessive abuse against door stops or walls.

### Flexibility

- Lock chassis design supports all cylinder formats allowing flexibility for from fixed core to interchangeable core cylinders.
- High Security and security key systems available (Access 3, Pyramid, etc.)
- Patented adjustable push/turn button for easy door thickness adjustment.
- Lever Release freewheeling levers standard for vandal resistance; rigid lever optional.

### Broad Offering

- Available with 27 mechanical and 2 electrified functions
- 14 finishes plus MicroShield® options
- Multiple lever options including decorative designs, behavioral health and visual status indicators

# Lever Trim

## CLX3300 Series with Lever Trim

### Levers - Solid Cast Zinc

#### Armstrong AZ

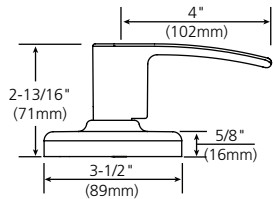

#### Newport\* NZ

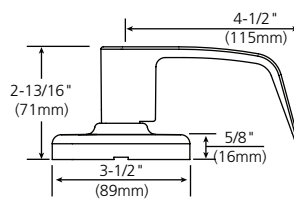

#### Princeton\* PZ

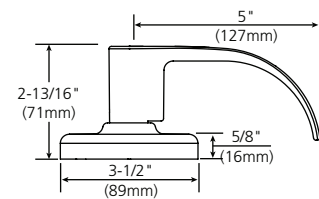

### Decorative Levers

#### 102

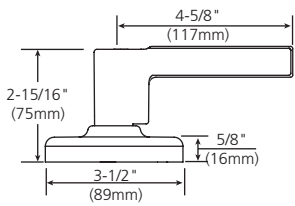

#### 106

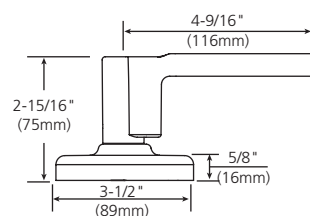

#### 123\*

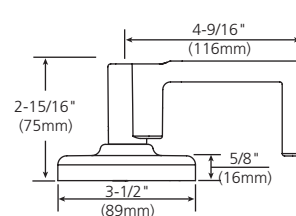

#### 124\*

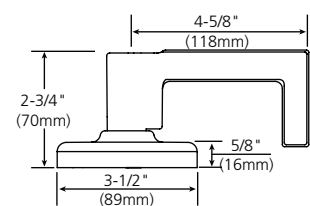

\*Lever with return to within 1/2" of door face.

### Rose Wrought Brass

#### D

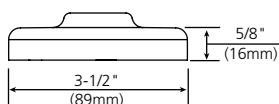

# Behavioral Health

## CLX3300 Series with BHSS Trim

Part of the Behavioral Health Series® of products, the CLX3300 Series cylindrical lock with BHSS trim has tapered surfaces and an integrated lever and escutcheon, bringing an elegant style to behavioral health environments. The BHSS trim is listed for low, medium and high risk areas in the widely recognized New York State Office of Mental Health (NYS-OMH) Patient Safety Standard.\* The heavy-duty design and ANSI/BHMA Grade 1 strength of the CLX3300 Series withstands abuse in any environment.

### BHSS

#### Lever & Escutcheon - Cast Stainless Steel

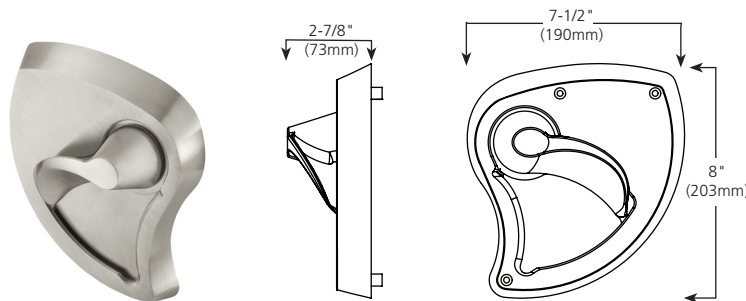

<b>Door Prep</b>	ANSI/SDI A250.14 modified. Refer to template T31261
<b>Door Thickness</b>	Adjustable 1-3/4" - 2" (44mm - 51mm)
<b>Minimum Stile</b>	8-1/2" (216mm)
<b>Handing</b>	Handed - must be specified on order
<b>Backset</b>	2-3/4" (70mm) backset w/ 1-1/8" (29mm) front (standard) 3-3/4" (95mm) backset w/ 1-1/8" (29mm) front (specify Quick Code B334) 5" (127mm) backset w/ 1-1/8" (29mm) front (specify Quick Code B500)
<b>Latchbolt</b>	Stainless steel, 1/2" (13mm) throw
<b>Front</b>	Wrought brass, bronze, or stainless steel 2-1/4" x 1-1/8" (57mm x 29mm) standard Accommodates flat doors and doors beveled 1/8" in 2" (3mm in 51mm)
<b>Strike</b>	Wrought brass or stainless steel ANSI curved lip standard, 4-7/8" x 1-1/4" x 1-1/4" (124mm x 32mm x 32mm) lip to center Optional strikes, lip lengths and ANSI wrought strike box available; see page 20
<b>Cylinder</b>	Brass, 6-pin L4 keyway, 0-bitted standard. See Quick Codes page 21.
<b>Keys</b>	Two nickel silver change keys per lock standard
<b>Masterkeying</b>	Can be master keyed or grand master keyed Construction key systems available
<b>Lead Lining</b>	Lead provided between lockbody and spring housing (specify Quick Code M28)
<b>Fasteners</b>	Security pin Torx® standard for exposed fasteners
<b>Finishes</b>	630, 630C
<b>Functions</b>	Available with functions as shown with the BHSS icon on pages 11-13 
<b>Outside Locked Lever</b>	Free-wheeling outside locked levers provided standard. For rigid levers specify Quick Code M200*
<b>Warranty</b>	Ten-year limited mechanical and two-year limited electronics

\*Although this product is better designed for behavioral health applications than traditional trim, it does not eliminate the risk that an object can be affixed to, or around it. A lockset function that requires a rigid lever when locked or a push/turnbutton may introduce a ligature opportunity. Refer to [Patient Safety Standards Guidelines](https://omh.ny.gov/omhweb/patient_safety_standards/) for the latest approved products ([https://omh.ny.gov/omhweb/patient\\_safety\\_standards/](https://omh.ny.gov/omhweb/patient_safety_standards/)).

# Indicators

## CLX3300 Series with VSL Trim

The CLX3300 Series cylindrical lock with status indicators, is the ultimate intersection of security and privacy. Engineered for easy installation in any space, it ensures instant visibility of the door's lock status. Featuring six customizable status indicator windows for optimal visibility, it offers indicators for both sides of the door, one-motion egress, non-handed installation, and keyed functions. Built on the robust CLX3300 Series lock body, it exceeds Grade 1 standards, making it ideal for high-traffic restrooms, classrooms, or rooms requiring increased privacy.

### Features

- Patented design
- Inside, outside or **both** sides of the door
  - Indicator option code must be specified, see page 9.
- Highly visible from all angles
- Non-handed
- Multiple door thickness options
- Available with a variety of functions

### NVSL

Lever - Solid Cast Zinc  
Rose - Wrought Brass



Door Prep	ANSI/SDI A250.14
Door Thickness	1-3/4" (44mm) standard - accommodates 1-11/16" - 1-15/16" (43mm - 49mm) doors 1-3/8" (35mm) specify Quick Code D138 for Adapter plates 2" (51mm) specify Quick Code D200 - accommodates 1-15/16" - 2-1/8" (49mm - 54mm) doors 2-1/4" (57mm) specify Quick Code D214 - accommodates 2-1/8" - 2-5/16" (54mm - 59mm) doors
Minimum Stile	4-1/2" (114mm)
Handing	Non-handed
Backset	2-3/4" (70mm) backset w/ 1-1/8" (29mm) front (standard) 2-3/8" (60mm) backset w/ 1" (25mm) wide front (specify Quick Code B238) 3-3/4" (95mm) backset w/ 1-1/8" (29mm) front (specify Quick Code B334) 5" (127mm) backset w/ 1-1/8" (29mm) front (specify Quick Code B500)
Latchbolt	Stainless steel, 1/2" (13mm) throw Optional: Brass, 3/4" (19mm) throw deadlocking fire latch for pair of doors (specify Quick Code M16)
Front	Wrought brass, bronze, or stainless steel Optional: rounded corners (specify Quick Code M13) 2-1/4" x 1-1/8" (57mm x 29mm) standard for 2-3/4" (70mm), 3-3/4" (95mm) and 5" (127mm) backset 2-1/4" x 1" (57mm x 25mm) standard for 2-3/8" (60mm) backset Accommodates flat doors and doors beveled 1/8" in 2" (3mm in 51mm)
Strike	Wrought brass or stainless steel ANSI curved lip standard, 4-7/8" x 1-1/4" x 1-1/4" (124mm x 32mm x 32mm) lip to center Optional strikes, lip lengths and ANSI wrought strike box available; see page 20
Cylinder	Brass, 6-pin L4 keyway, 0-bitted standard. See Quick Codes page 21.
Keys	Two nickel silver change keys per lock standard
Masterkeying	Can be master keyed or grand master keyed Construction key systems available
Lead Lining	Lead provided between lockbody and spring housing (specify Quick Code M28)
Finishes	See page 23
Functions	Available with functions as shown on pages 11-13 with the VSL icon 
Outside Locked Lever	Free-wheeling outside locked levers provided standard. For rigid levers specify Quick Code M200
Warranty	Ten-year limited

# Indicators

## CLX3300 Series with VSL Trim

### Functions

Indicators are available with the following CLX3300 Series functions.

Function	Description
CLX3320	Privacy, Bedroom or Bathroom (F76A)
CLX3330	Privacy, Bedroom or Bathroom (F76A)
CLX3320H	Hospital Privacy
CLX3340	Patio or Privacy (F77A)
CLX3351	Entrance or Office (F109)
CLX3352	Classroom Intruder (F110) Inside only*
CLX3355	Classroom (F84)
CLX3357	Storeroom or Closet (F86)
CLX3361	Entry or Office (F82A)
CLX3375	Dormitory (F90) Outside only
CLX3376	Dormitory
CLX3393	Service Station (F92)

\*Provided standard with Key Turn Indicator as shown on page 10.

### How To Order

When ordering CLX3300 Series indicator trim, the NVSL trim designation must be specified in addition to the indicator option code. If indicators are specified on one side of the door only, the non-indicator side will be supplied with NZD trim unless otherwise ordered.

### How To Order Examples

#### Indicator Outside Only

Function	Outside Design & Trim	Inside Design & Trim	Hand	Finish	Options
CLX3320	NVSL	NZD	RH	626	V30

Privacy function with indicator on **outside only in green/red**. Inside would be provided with NZD trim.

Function	Outside Design & Trim	Inside Design & Trim	Hand	Finish	Options
CLX3361	NVSL	102D	RH	626	V30

Entry function with indicator on **outside only in green/red**. Inside would be provided with 102D trim.

#### Indicator Inside Only

Function	Outside Design & Trim	Inside Design & Trim	Hand	Finish	Options
CLX3320	NZD	NVSL	RH	626	V06

Privacy function with indicator on **inside only in white/red**. Outside would be provided with NZD trim.

Function	Outside Design & Trim	Inside Design & Trim	Hand	Finish	Options
CLX3320	102D	NVSL	RH	626	V06

Privacy function with indicator on **inside only in white/red**. Outside would be provided with 102D trim.

#### Indicator Both Sides

Function	Design	Trim	Hand	Finish	Options
CLX3320	N	VSL	RH	626	V33

Privacy function with indicator on **both sides in green/red**.

### Indicator Option Codes

CLX3300 Series indicator option codes are designed to convey color and side of door desired in one simple code. To order, specify option code.

Single Indicator			
Option Code	Outside	Inside	Color
V30	Indicator Trim	Standard Trim	Green/Red
V60	Indicator Trim	Standard Trim	White/Red
V03	Standard Trim	Indicator Trim	Green/Red
V06	Standard Trim	Indicator Trim	White/Red

Double Indicator			
Option Code	Outside	Inside	Color
V33	Indicator Trim	Indicator Trim	Green/Red
V66	Indicator Trim	Indicator Trim	White/Red



# Indicators

## CLX3300 Series

### Red Button Option

The CLX3300 Series locksets are available with an optional red push or turn button for increased visibility to status.

Providing the red push button allows users to easily see if the button is pushed in to indicate the outside lever is locked.

### Features

- Available for all push/turn button functions
- Bright red powder coat finish to easily see from a distance
- Economical solution for status indication

### How to Order

Specify option code "RPB".

Available with the following functions:

Function	Description
CLX3320	Privacy (F76A) Em Key
CLX3330	Privacy (F76A) Coin turn
CLX3320H	Hospital Privacy (Inside only)
CLX3329	Hotel (F93)
CLX3340	Patio (F77A)
CLX3351	Entry (F109)
CLX3361	Entry (F82A)
CLX3375	Dormitory (F90)
CLX3376	Dormitory
CLX3393	Service Station (F92)



### Order Example

Function	Trim	Finish	Hand	Option
CLX3320	NZD	626	RH	RPB

### Key Turn Indicator

The CLX3352 Classroom Intruder function lockset allows locking of the outside lever from either side with the key. The Key Turn Indicator is provided standard for the inside lever on this function and in a panic situation, it serves as a quick reference for locking the door. Egress is always possible with the "anti-panic" feature, which keeps the outside lever locked if the inside lever is activated.



# Functions

## CLX3300 Series

Outside	Inside	Series/Function	Type	ANSI No.	Function Description
		CLX3310	Passage or Closet	F75	<ul style="list-style-type: none"> <li>Latchbolt by lever either side</li> <li>Both levers always free</li> </ul>
		CLX3320	Privacy, Bedroom or Bathroom	F76A	<ul style="list-style-type: none"> <li>Outside lever locked by push button (lever handle is freewheeling in locked position)</li> <li>Outside lever unlocked by emergency release tool outside, by rotating inside lever or by closing door</li> <li>Inside lever always free</li> </ul>
		CLX3330	Privacy, Bedroom or Bathroom	F76A	<ul style="list-style-type: none"> <li>Outside lever locked by push button (lever handle is freewheeling in locked position)</li> <li>Outside lever unlocked by emergency cointurn outside, by rotating inside lever or by closing door</li> <li>Inside lever always free</li> </ul>
		CLX3320H	Hospital Privacy	—	<ul style="list-style-type: none"> <li>Outside lever locked by inside push button (lever handle is freewheeling in locked position)</li> <li>Outside lever unlocked by simultaneously depressing outside pushbutton while rotating lever</li> <li>Rotating inside lever or closing door also unlocks outside lever</li> <li>Outside lever handle is freewheeling when locked</li> </ul>
		CLX3320TO	Time Out Lock	—	<ul style="list-style-type: none"> <li>Latchbolt by lever either side (passage) unless push button depressed and held by caretaker (detention side becomes freewheeling). Lock returns to passage mode upon release of push button.</li> <li>Push button automatically releases when caretaker releases push button</li> <li>Both levers always free</li> </ul>
		CLX3329	Hotel or Motel	F93	<ul style="list-style-type: none"> <li>Deadlocking latchbolt by lever inside or by key outside</li> <li>Push button shuts out all keys except emergency key, and projects occupancy indicator in face of cylinder (lever handle is freewheeling in locked position)</li> <li>Push button released by turning inside lever or by closing door, unless push button has been fixed in locked position by spanner key (provided).</li> <li>When push button is fixed in locked position by spanner key, lock is operable only by emergency key.</li> <li>Outside lever always locked</li> <li>Inside lever always free</li> <li>Not available with other manufacturers keyways</li> </ul>
		CLX3332	Institutional or Utility	F87	<ul style="list-style-type: none"> <li>Deadlocking latchbolt by key either side (lever handles are freewheeling in locked position)</li> <li>Should be used only in office or room with multiple entries</li> <li>Keyed alike unless otherwise specified</li> </ul>
		CLX3340	Patio or Privacy	F77A	<ul style="list-style-type: none"> <li>Deadlocking latchbolt by lever</li> <li>Outside lever locked by push button (lever handle is freewheeling in locked position)</li> <li>Outside lever unlocked by operating inside lever or closing door</li> <li>Inside lever always free</li> <li>Should not be used in rooms that have no other entrance</li> </ul>
		CLX3340NT	Exit Latch	F89	<ul style="list-style-type: none"> <li>Deadlocking latchbolt by lever inside</li> <li>Outside lever always locked (lever handle is freewheeling in locked position)</li> <li>Inside lever always free</li> </ul>

Indicates optional interchangeable core available; see Quick Codes, page 21.



Indicates freewheeling lever in locked position. Specify Quick Code M200 for rigid lever in locked position.



Indicates function available with BHSS trim.

Indicates function available with RPB option.



Indicates function available with VSL trim.

# Functions

## CLX3300 Series

Outside	Inside	Series/Function	Type	ANSI No.	Function Description
		CLX3351	Entrance or Office	F109	<ul style="list-style-type: none"> <li>Deadlocking latchbolt by lever either side, except when turn button locks outside lever. Pushing turn button in locks outside lever, requiring use of key outside to unlock. (Lever handle is freewheeling in locked position)</li> <li>Turning inside lever unlocks outside lever</li> <li>Pushing in and turning button locks outside lever, requiring key at all times. Turning inside lever does not unlock outside lever until button is manually turned to unlocked position.</li> <li>Inside lever always free</li> </ul>
		CLX3352	Classroom Intruder	F110	<ul style="list-style-type: none"> <li>Deadlocking latchbolt by inside lever or outside lever except when key inside or outside locks outside lever (lever handle is freewheeling in the locked position)</li> <li>Outside lever is locked and unlocked by turning the key in the inside or outside lever</li> <li>Inside lever always free</li> </ul> <p>Note: Inside lever engraved with "Lock" arrow showing direction to rotate key to lock.</p>
		CLX3355	Classroom	F84	<ul style="list-style-type: none"> <li>Deadlocking latchbolt by lever either side, except when key outside locks outside lever (lever handle is freewheeling in locked position)</li> <li>Outside lever unlocked by key outside</li> <li>Inside lever always free</li> </ul>
		CLX3357	Storeroom or Closet	F86	<ul style="list-style-type: none"> <li>Deadlocking latchbolt by key in outside lever or by rotating inside lever (lever handle is freewheeling in locked position)</li> <li>Inside lever always free</li> </ul>
		CLX3359	Barrier Free Storeroom or Public Restroom	—	<ul style="list-style-type: none"> <li>Deadlocking latchbolt by inside lever</li> <li>Key outside unlocks outside lever to retract latchbolt</li> <li>Key is retained in unlock mode</li> <li>When key is removed outside lever is locked (lever handle is freewheeling in locked position)</li> <li>Inside lever always free</li> </ul>
		CLX3361	Entry or Office	F82A	<ul style="list-style-type: none"> <li>Deadlocking latchbolt by lever either side, except when push button locks outside lever</li> <li>Push button released by turning inside lever or by key in outside lever (lever handle is freewheeling in locked position)</li> <li>Closing door does not release push button</li> <li>Inside lever always free</li> </ul>
		CLX3362	Communicating	F80	<ul style="list-style-type: none"> <li>Deadlocking latchbolt by lever either side, except when key in either lever locks and unlocks the lever independently of the other (lever handle is freewheeling in locked position)</li> <li>Keyed alike unless otherwise specified</li> <li>Should be used only in office or room with multiple entries</li> </ul>
		CLX3372	Apartment, Exit or Public Toilet	F88	<ul style="list-style-type: none"> <li>Deadlocking latchbolt by lever either side, except when key inside locks outside lever (lever handle is freewheeling in locked position)</li> <li>Key outside retracts latchbolt</li> <li>Key inside unlocks outside lever</li> <li>Inside lever always free</li> <li>Keyed alike unless otherwise specified</li> </ul>

 Indicates optional interchangeable core available; see Quick Codes, page 21.



Indicates freewheeling lever in locked position. Specify Quick Code M200 for rigid lever in locked position.



Indicates function available with BHSS trim.







 Indicates function available with RPB option.



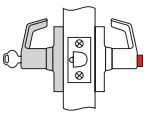

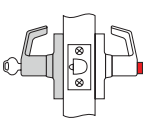
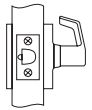
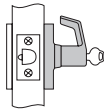
Indicates function available with VSL trim.

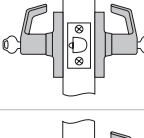
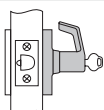
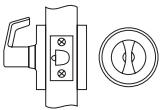
# Functions

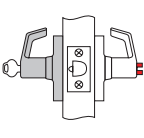
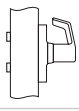
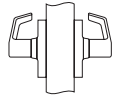
## CLX3300 Series

Outside	Inside	Series/Function	Type	ANSI No.	Function Description
		CLX3375	Corridor/ Dormitory Lock	F90	<ul style="list-style-type: none"> <li>Deadlocking latchbolt by lever either side except when pushbutton or key locks outside lever</li> <li>Pushbutton released by turning inside lever or by closing door</li> <li>Depressed pushbutton indicates door is locked</li> <li>When outside lever is locked by key, it can only be unlocked by key</li> <li>Inside lever always free</li> </ul>
		CLX3376	Corridor/ Dormitory Lock	F90 (Modified)	<ul style="list-style-type: none"> <li>Deadlocking latchbolt by lever either side except when pushbutton or key locks outside lever</li> <li>Pushbutton released by turning inside lever or by closing door</li> <li>Depressed pushbutton indicates door is locked</li> <li>When outside lever is locked by push button or key, it can be unlocked by key, turning inside lever or closing door</li> <li>Inside lever always free</li> </ul>
		CLX3380	Passage Lever x Blank Plate	F111	<ul style="list-style-type: none"> <li>Deadlocking latchbolt by lever</li> <li>Lever on one side; blank plate on other side</li> <li>Lever always free</li> <li>For single or double communicating doors</li> </ul>
		CLX3381	Classroom x Blank Plate	F113	<ul style="list-style-type: none"> <li>Deadlocking latchbolt by lever, except when lever is locked by key (lever handle is freewheeling in locked position)</li> <li>Lever on one side; blank plate on other side</li> <li>Key unlocks lever</li> </ul>
		CLX3382	Store Door Lock	F91	<ul style="list-style-type: none"> <li>Deadlocking latchbolt by lever either side, except when both levers are locked by key from either side (lever handle is freewheeling in locked position)</li> <li>Keyed alike unless otherwise specified</li> <li>Should be used only in office or room with multiple entries</li> </ul>
		CLX3383	Storeroom x Blank Plate	F112	<ul style="list-style-type: none"> <li>Deadlocking latchbolt by key in lever (lever handle is freewheeling in locked position)</li> <li>Lever always locked</li> <li>Lever on one side; blank plate on other side</li> </ul>
		CLX3390	Passage Lever x Turnpiece	—	<ul style="list-style-type: none"> <li>Deadlocking latchbolt by lever or by turnpiece</li> <li>Lever on one side; turnpiece on other side</li> <li>Lever and turnpiece always free</li> </ul>
		CLX3393	Service Station	F92	<ul style="list-style-type: none"> <li>Deadlocking latchbolt by lever</li> <li>Outside lever locked by slotted push button (lever handle is freewheeling in locked position)</li> <li>When slotted push button is pushed in and turned, outside lever becomes freewheeling and deadlocking latch is activated. Outside lever is unlocked by using key or by rotating inside lever, when slotted push button returned to original position.</li> <li>Inside lever always free</li> </ul>
		CLX3350	Half Dummy Trim	—	<ul style="list-style-type: none"> <li>Lever acts as pull only; no operation</li> <li>Lever is rigid</li> </ul>
		CLX3370	Full Dummy Trim	—	<ul style="list-style-type: none"> <li>Levers act as pulls only; no operation</li> <li>Levers are rigid</li> </ul>

 Indicates optional interchangeable core available; see Quick Codes, page 21.

 Indicates freewheeling lever in locked position. Specify Quick Code M200 for rigid lever in locked position.

 Indicates function available with BHSS trim.

 Indicates function available with RPB option.

 Indicates function available with VSL trim.

# Technical Details

## CLX33900 Electrified Lock

The CLX33900 electrified lock provides remote locking and unlocking, utilizing the CLX3300 Series cylindrical lock. It is ideal for door control where increased security is necessary at all times, while meeting life safety codes.



### Featuring EcoFlex®



- Reduces energy consumption up to 92%, as certified by GreenCircle
  - Lower operating costs
  - Assists with load reduction in optimizing energy performance credit in LEED
  - Reduces number of power supplies required
- Field configurable to fail-safe or fail-secure
- Operates from 12-24VDC, offering greater flexibility in system design
- Innovative actuator design provides superior reliability
  - Higher performance and reduced maintenance
  - Ability to have longer cable runs without negatively impacting lock function
  - Reduces risk of voltage drops and eliminates inductive kickback
  - Lower total cost of ownership

Door Prep	ANSI/SDI A250.14
Door Thickness	1-3/4" - 2" (44mm - 51mm) Over 2" (51mm) up to 2-1/4" (57mm), specify Quick Code D214
Minimum Stile	4-1/2" (114mm)
Handing	Non-handed
Backset	2-3/4" (70mm) backset w/ 1-1/8" (29mm) front (standard) 3-3/4" (95mm) backset w/ 1-1/8" (29mm) front (specify Quick Code B334) 5" (127mm) backset w/ 1-1/8" (29mm) front (specify Quick Code B500)
Latchbolt	Stainless steel, 1/2" (13mm) throw Optional: Brass, 3/4" (19mm) throw deadlocking fire latch for pair of doors (specify Quick Code M16)
Front	Wrought brass, bronze, or stainless steel Optional: rounded corners (specify Quick Code M13) 2-1/4" x 1-1/8" (57mm x 29mm) standard for 2-3/4" (70mm), 3-3/4" (95mm) and 5" (127mm) backset 2-1/4" x 1" (57mm x 25mm) standard for 2-3/8" (60mm) backset Accommodates flat doors and doors beveled 1/8" in 2" (3mm in 51mm)
Strike	Wrought brass or stainless steel ANSI curved lip standard, 4-7/8" x 1-1/4" x 1-1/4" (124mm x 32mm x 32mm) lip to center Optional strikes, lip lengths and ANSI wrought strike box available; see page 20
Cylinder	Brass, 6-pin L4 keyway, 0-bitted standard, see Quick Codes page 21
Keys	Two nickel silver standard
Masterkeying	Can be master keyed or grand master keyed Construction key systems available
Voltage	Accommodates 12VDC or 24VDC (Operating range 10.2VDC to 26.4VDC). Lock is polarity sensitive.
Electrical Specifications	Fail Safe / Fail Secure Current draw: 10mA @ 12VDC or 24VDC Continuous Peak current draw: 500mA @ 12VDC or 24VDC (Maximum of 2 locks per 1A Power Supply) Monitor switch rating: 500mA Max to 24VDC
Electrical Options	Request to Exit switch for monitoring activation of the inside lever (specify Quick Code M92)
Operating Temperature	-13°F (-25°C) to 151°F (66°C)
Operating Humidity	5% to 95% relative humidity non condensing
ElectroLynx®	Provided with 8-pin molex connector
Finishes	See page 23
Warranty	Two-year limited

### Functions

Outside	Inside	Series/Function	Function Description
		CLX33903	Fail Safe <ul style="list-style-type: none"> <li>• Deadlocking latchbolt by lever either side except when power on locks outside lever</li> <li>• Power off/unlocks outside lever</li> <li>• Inside lever always free</li> <li>• Latchbolt retracted by key when locked electrically</li> </ul>
		CLX33905	Fail Secure <ul style="list-style-type: none"> <li>• Deadlocking latchbolt by lever either side except when power off locks outside lever</li> <li>• Power on/unlocks outside lever</li> <li>• Inside lever always free</li> <li>• Latchbolt retracted by key when power is off</li> </ul>



Indicates function available with BHSS trim.

# Electrical Accessories

## CLX33900 Electrified Lock

### Requirements for Electrical and Data Transfer

To answer the demand for "smart" electronic access control and locking solutions that require fast, easy, and cost-effective installation, ASSA ABLOY Group brands use the ElectroLynx® standardized plug-in connectors and color-coded wiring system.

With *ElectroLynx*, doorway components come pre-wired for easy hookup to the power source. Key to the system is the transfer device hinge that carries power from the frame to the locking hardware.

### Features of ElectroLynx:

- Makes it easy to bring power to the locking hardware
- Wires have connectors that snap together, like plugging a telephone into a jack

To connect a CLX33900 electrified cylindrical lock to the electronic access control system, the following items are required:

- CLX33900 electrified cylindrical lock
- ASSA ABLOY Door Group pre-wired door, or *ElectroLynx* retrofit cable (order from McKinney)
- Electronic transfer device (*ElectroLynx* electronic transfer hinge or Electrical Power Transfer with standard hinge, from McKinney)
- *ElectroLynx* cable from the hinge to above the ceiling (order from McKinney)

Information regarding cable selection, hinge requirements and order strings can be found in the McKinney Transfer Device Solutions catalog. Consult 800-810-WIRE (9473) with questions on application specifications and requirements.

The McKinney QC8 *ElectroLynx* Hinge is recommended for the CLX33903 function, the CLX33905 function and the M92 (REX) option.

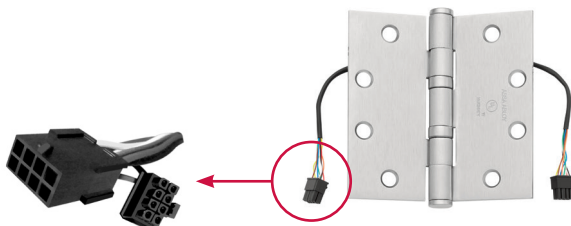

### LSP-12-24 Power Supply

#### Operation

LifeSafety Power supplies are designed to provide reliable filtered and regulated power for long life to a variety of electrified hardware components.

#### Features

- Selectable voltage output between 12V and 24V with a single switch
- Internal Back-Up battery charging circuit \*
- Regulated and filtered, fuse protected outputs
- Each output can be individually turned on and off via a jumper
- Power status of each output is shown by an LED
- Rugged steel enclosure
- Fire alarm interface included – Dry contacts NO/NC, 9-33VDC, 3-15mA

#### Electrical Specifications

- Inputs: 120VAC
- Outputs: 12VDC @ 6 Amp or 24VDC @3 Amp  
– 8 Total Outputs

#### Listings

- UL294, UL603, UL1076
- ULC S318, ULC S319

#### Applications

- Fail safe cylindrical locks
- Fail secure cylindrical locks

\* Note: Batteries are not included with the power supply

Model No.	Description
LSP-12-24	12V – 6AMP / 24V – 3AMP Power Supply



# Cylinders

## CLX3300 Series

### Corbin Russwin Cylinders

#### Fixed Core

Description	Pins	Door Thickness	Model Number Used with CLX3300 Mechanical Functions	Model Number Used with CLX33900 Electrified Functions
Conventional	6	1-3/8" - 2"	CR2000-034 (Std.)	CR2000-E34 (Std.)
		2-1/4"	CR2000-034L	CR2000-E34L
	7	1-3/8" - 2"	CR2000-034-7	CR2000-E34-7
		2-1/4"	CR2000-034L-7	CR2000-E34L-7
Hotel	6	1-3/8" - 2-1/4"	CR2001-034A	N/A
	7		CR2001-034A-7	
Security	6	1-3/8" - 2"	CR2010-034	CR2010-E34
		2-1/4"	CR2010-034L	CR2010-E34L
Pyramid - Security	7	1-3/8" - 2"	CR2027-034	CR2027-E34
		2-1/4"	CR2027-034L	CR2027-E34L
Pyramid - High Security	7	1-3/8" - 2"	CR2020-034	CR2020-E34
		2-1/4"	CR2020-034L	CR2020-E34L
Access 3 <sup>®</sup> - Patented (AP)	6	1-3/8" - 2"	CR2500-034	CR2500-E34
		2-1/4"	CR2500-034L	CR2500-E34L
Access 3 <sup>®</sup> - Patented Hotel (AP)	6	1-3/8" - 2-1/4"	CR2501-034A	N/A
Access 3 <sup>®</sup> - Security (AS)	6	1-3/8" - 2"	CR2600-034	CR2600-E34
		2-1/4"	CR2600-034L	CR2600-E34L
Access 3 <sup>®</sup> - Security Hotel (AS)	6	1-3/8" - 2-1/4"	CR2601-034A	N/A
Access 3 <sup>®</sup> - High Security (AHS)	6	1-3/8" - 2"	CR2700-034	CR2700-E34
		2-1/4"	CR2700-034L	CR2700-E34L
Access 3 <sup>®</sup> - High Security Hotel (AHS)	6	1-3/8" - 2-1/4"	CR2701-034A	N/A

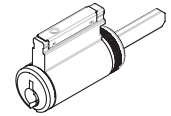

- Plug diameter for conventional cylinders is .509, .510 for Access 3<sup>®</sup>, .552 for security cylinders and .496 for Pyramid cylinders.
- Cylinders are brass and come with 2 nickel silver keys.
- Finishes: 606, 626 or BSP.
- To order cylinders separately, specify Model No. x Keyway x Finish (e.g., CR2000-034 x L4 x 626). Refer to CLX3300 Series Parts Manual for tailpiece information.

#### Large Format Interchangeable Core

Description	Pins	Model Number Used with All Functions
Conventional	6	CR8000
	7	CR8000-7
Hotel	6	CR8001-034A
	7	CR8001-034A-7
Security	6	CR8010
Pyramid - Security	7	CR8020
Pyramid - High Security	7	CR8027
Access 3 <sup>®</sup> - Patented (AP)	6	CR8500
Access 3 <sup>®</sup> - Security (AS)	6	CR8600
Access 3 <sup>®</sup> - High Security (AHS)	6	CR8700
Access 3 <sup>®</sup> - Hotel Patented (AP)	6	N/A
Access 3 <sup>®</sup> - Hotel Security (AS)	6	N/A
Access 3 <sup>®</sup> - Hotel High Security (AHS)	6	N/A

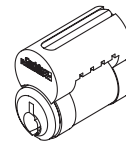

- Plug diameter for conventional cores is .509, .510 for Access 3<sup>®</sup>, .552 for security cylinders and .496 for Pyramid cylinders.
- Cores are brass and come with 2 nickel silver keys.
- Finishes: 606, 626 or BSP.
- To order cores separately, specify Model No. x Keyway x Finish (e.g., CR8000 x L4 x 626). Refer to CLX3300 Series Parts Manual for tailpiece information.

### Small Format Interchangeable Core

Description	Model Number Used with All Functions
6-pin	CR8200
7-pin	CR8200-7

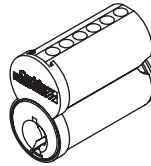

- Cores are available in Best® keyways A, B, C, D, E, F, G, H, J, K, L, M.
- Cores are brass and come with 2 nickel silver keys.
- Finishes: 606, 626

### Cylinders with Competitive Keyways

Description	Pins	Door Thickness	Model Number Used with CLX3300 Mechanical Functions	Model Number Used with CLX33900 Electrified Functions
Schlage® C (0-bitted)	6	1-3/8" - 2"	CR2400-034-C	CR2400-E34-C
		2-1/4"	CR2400-034L-C	CR2400-E34L-C
Schlage® C (keyed random)	6	1-3/8" - 2"	CR2400-034-C-KR	CR2400-E34-C-KR
		2-1/4"	CR2400-034L-C-KR	CR2400-E34L-C-KR
SARGENT® LA (0-bitted)	6	1-3/8" - 2"	CR2400-034-LA	CR2400-E34-LA
		2-1/4"	CR2400-034L-LA	CR2400-E34L-LA

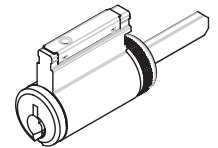

Finishes: 606, 626

# Cylinders

## CLX3300 Series

### Levers That Accept Competitive Interchangeable Core Cylinders\*

Cylinder Type	Quick Code
SFIC 6 or 7-pin (all designs)	M08 Tailpiece included
Schlage® 6-pin LFIC (AZ, NZ, PZ, BHSS, NVSL only)	M69 Tailpiece included
ASSA ABLOY ACCENTRA™ 6-pin LFIC 1210, 5210, K800-6 (AZ, NZ, PZ, NVSL only)	YRC Tailpiece included

\*Core not included.

Refer to CLX3300 Series Parts Manual for tailpiece information.

### Adapters Required to Accept Competitive Cylinders\*

Competitive Cylinder	Quick Code
Schlage® 6-pin fixed core Conventional (21-002, 23-001, 23-013) or Primus® (20-548, 20-550, 20-748, 20-750)	M06 Tailpiece included
SARGENT® 6-pin fixed core C10X-1	M09 Tailpiece and special lever included
ASSA ABLOY ACCENTRA™ 6-pin fixed core 1803, 5803, K403	YC Tailpiece included
ASSA ABLOY ACCENTRA™ 7-pin fixed core 1803A, 5803A, K403A	YC7 Tailpiece included

\*Cylinder not included.

Refer to CLX3300 Series Parts Manual for tailpiece information.

### Miscellaneous

Description	Door Thickness	Model Number Used with CLX3330 Function Only
Emergency release cylinder	1-3/8" - 2"	CR2000C-034
	2-1/4"	CR2000C-034L

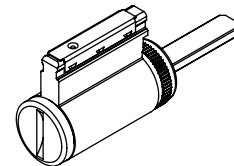

### Latches

To order optional latch with lockset, see Backset Quick Codes, page 21.

To order latch separately, specify Part No. x Finish (e.g., 867F20 x 626).

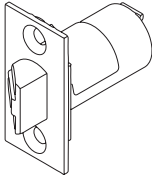
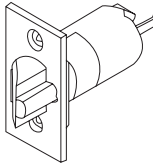
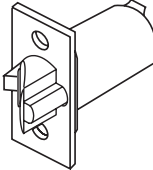
Backset and Front Description	Plain For CLX3310, CLX3320, CLX3320H, CLX3320TO	Deadlocking For All Other Mechanical Functions	Deadlocking For All Electrified Functions	3/4" (19mm) Throw Deadlocking Fire Latch for Pair of Doors
<b>2-3/4" (70mm) Backset</b>				
Square corner front, 2-1/4" (57mm) x 1-1/8" (29mm) (standard)	867F20	867F21	867F32	601F69 605, 606 and 626 finishes available
Rounded corner front, 2-1/4" (57mm) x 1-1/8" (29mm)	867F26	867F27	867F35	Not available
<b>2-3/8" (60mm) Backset</b>				
Square corner front, 2-1/4" (57mm) x 1" (25mm) (standard with B238 option)	897F60*	897F61*	Not available	Not available
Rounded corner front, 2-1/4" (57mm) x 1" (25mm)	897F64*	897F65*	Not available	Not available
Square corner front, 2-1/4" (57mm) x 1-1/8" (29mm)	897F58*	897F59*	Upon request	Not available
Rounded corner front, 2-1/4" (57mm) x 1-1/8" (29mm)	897F62*	897F63*	Upon request	Not available
<b>3-3/4" (95mm) Backset</b>				
Square corner front, 2-1/4" (57mm) x 1-1/8" (29mm)	867F22	867F23	867F33	Not available
Rounded corner front, 2-1/4" (57mm) x 1-1/8" (29mm)	867F28	867F29	867F36	Not available
<b>5" (127mm) Backset</b>				
Square corner front, 2-1/4" (57mm) x 1-1/8" (29mm)	867F24	867F25	867F34	Not available
Rounded corner front, 2-1/4" (57mm) x 1-1/8" (29mm)	867F30	867F31	867F37	Not available
				

\*These latchbolts are only compatible with 2-3/8" lockbodies shipped after October 1, 2024. For 2-3/8" latches used with lockbodies shipped prior to October 1, 2024, contact Technical Product Support.

# Strikes

## CLX3300 Series

### Strikes

#### ANSI Curved Lip (standard)

Brass or stainless steel.

4-7/8" (124mm) x 1-1/4" (32mm) x 1-1/4" (32mm) lip to center.

Optional lip lengths:

1" (25mm), 1-1/8" (29mm), 1-3/8" (35mm), 1-1/2" (38mm), 1-3/4" (44mm), 2" (51mm), 2-1/4" (57mm), 2-1/2" (64mm), 2-3/4" (70mm), 3" (76mm).

To order with lockset, see Quick Codes below.

To order separately, specify 217L13 x Lip Length x Finish.

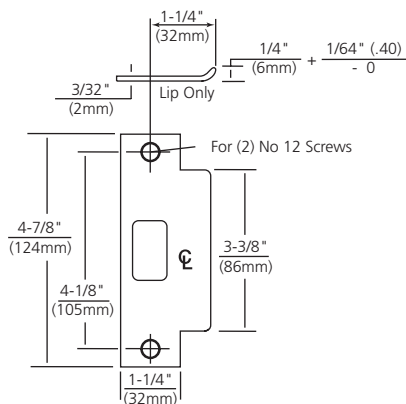

#### Curved Lip "T" Strike

Brass.

2-3/4" (70mm) x 1-1/8" (29mm) x 1-1/4" (32mm) lip to center.

Optional lip lengths: 1" (25mm), 1-1/8" (29mm), 1-3/8" (35mm), 1-1/2" (38mm), 1-3/4" (44mm), 2" (51mm), 2-1/4" (57mm), 2-1/2" (64mm), 2-3/4" (70mm), 3" (76mm).

To order with lockset, see Quick Codes below.

To order separately, specify 586L19 x Lip Length x Finish.

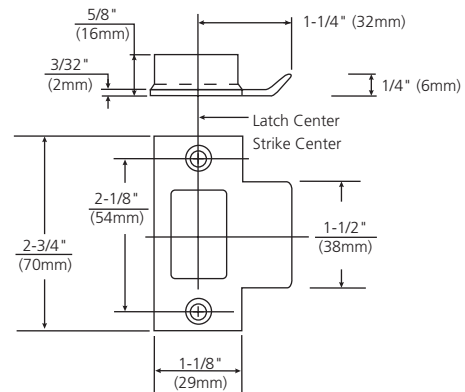

#### Full Lip Strike

Brass.

2- 3/4" (70mm) x full lip x 1-1/8" (29mm) lip to center.

No optional lip lengths.

To order with lockset, see Quick Codes below.

To order separately, specify 607F76.

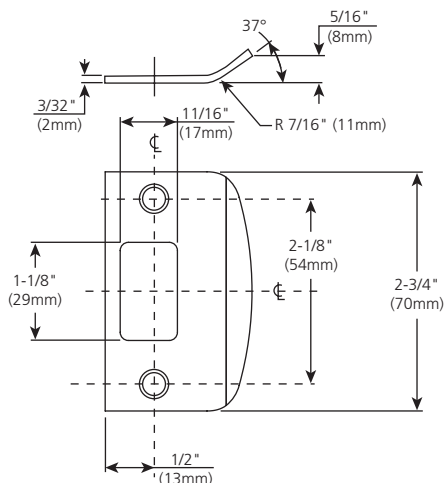

#### ANSI Wrought Strike Box

Used with ANSI 4-7/8" (124mm) strike .

To order with lockset, specify Quick Code M17.

To order separately, specify 120F768.

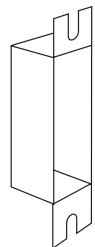

### Strikes

ANSI Lip to Center	ANSI Curved Lip Specify	T-Strike Curved Lip Box Specify	Full Lip Specify
1" (25mm)	SA100	SC100	
1-1/8" (29mm)	SA118	SC118	SF118
1-1/4" (32mm)	SA114 (standard)	SC114	
1-3/8" (35mm)	SA138	SC138	
1-1/2" (38mm)	SA112	SC112	
1-3/4" (44mm)	SA134	SC134	
2" (51mm)	SA200	SC200	
2-1/4" (57mm)	SA214	SC214	
2-1/2" (64mm)	SA212	SC212	
2-3/4" (70mm)	SA234	SC234	
3" (76mm)	SA300	SC300	

# Quick Codes

## CLX3300 Series

### Cylinder and Keying

Description	Specify
Conventional 6-pin	(standard)
Conventional 7-pin	7P
Less Cylinder(s)	LC
<b>LFIC</b>	
LFIC 6-pin	C6
LFIC 6-pin Less Core	CL6
LFIC 6-Pin Disposable Core <sup>1</sup>	CT6D
LFIC 6-pin with Temporary Construction Core (Red) <sup>1</sup>	CT6R
LFIC 6-pin with Temporary Construction Core (Blue) <sup>1</sup>	CT6B
LFIC 6-pin with Temporary Construction Core (Green) <sup>1</sup>	CT6G
LFIC 7-pin	C7
LFIC 7-pin Less Core	CL7
LFIC 7-Pin Disposable Core <sup>1</sup>	CT7D
LFIC 7-pin with Temporary Construction Core (Red) <sup>1</sup>	CT7R
LFIC 7-pin with Temporary Construction Core (Blue) <sup>1</sup>	CT7B
LFIC 7-pin with Temporary Construction Core (Green) <sup>1</sup>	CT7G
<b>SFIC (all lever designs)<sup>1</sup></b>	
SFIC 6-pin	C6S
SFIC 6- or 7-pin Disposable Core	CTSD
SFIC 6-pin with Temporary Construction Core (Blue)	CT6SB
SFIC 7-pin	C7S
SFIC 7-pin with Temporary Construction Core (Blue)	CT7SB
<b>Security</b>	
Security <sup>1</sup>	HS
Security LFIC <sup>1</sup>	CHS
<b>Access 3<sup>®</sup></b>	
Access 3 Patented Fixed Core	AP
Access 3 Security Fixed Core	AS
Access 3 High Security Fixed Core	AHS
Access 3 Patented LFIC <sup>1</sup>	ACP
Access 3 Security LFIC <sup>1</sup>	ACS
Access 3 High Security LFIC <sup>1</sup>	ACHS

### Door Thickness

Door Thickness	Specify
1-3/4" - 2" (44mm - 51mm)	(standard)
1-3/8" (35mm) Adapter plates <sup>2,3</sup>	D138
2" (51mm) VSL trim only <sup>4</sup>	D200
Over 2" - 2-1/4" (51mm - 57mm) <sup>3,4</sup>	D214

- Lock provided with adapter (spacer) plates. Supplied with 2-3/8" backset latch with 1" front unless B234 specified.
- Not available with BHSS trim
- Refer to page 8 for VSL door thickness range.

Description	Specify
<b>Pyramid</b>	
Pyramid Security Fixed Core <sup>1</sup>	PS
Pyramid High Security Fixed Core <sup>1</sup>	PHS
Pyramid Security LFIC <sup>1</sup>	PCS
Pyramid High Security LFIC <sup>1</sup>	PCHS
Pyramid LFIC Less Core <sup>1</sup>	CLP
Pyramid with Temporary Construction Core <sup>1</sup>	CTP
Pyramid Disposable Core <sup>1</sup>	CTPD
<b>Keying and Keys</b>	
0-bitted with 2 blank keys	(standard)
Keyed Random	KR
Construction Master Keyed	CMK
2 keys per lock	(standard)
More than 2 keys	KY# (e.g., KY6)
<b>Visual Key Control (VKC)</b>	
No biting or keyset stamping on keys	VKC0
Keys only	VKC1
Cylinders and keys (not for AS, AHS, ACS, ACHS, HS, CHS, PHS or PCHS)	VKC2
Cylinders only (not for AS, AHS, HS, ACS, ACHS, CHS, PHS or PCHS)	VKC3
<b>Concealed Key Control (CKC)</b>	
CKC cylinders with VKC keys	CKC2
CKC cylinders only (not for AS, AHS, ACS, ACHS, PHS, PCHS)	CKC3
Schlage <sup>®</sup> C keyway cylinder (0-Bitted or KR) <sup>1</sup>	C
SARGENT <sup>®</sup> LA keyway cylinder (0-Bitted) <sup>1</sup>	LA

- Not available in CLX3329 function

### Backset

Description	Specify
2-3/4" (70mm)	B234 (standard)
2-3/8" (60mm) <sup>3</sup>	B238
3-3/4" (95mm)	B334
5" (127mm)	B500

# Quick Codes

## CLX3300 Series

### Visual Status Indicator Options

Description	Specify
Push/Turn button provided with red powder coat finish (see page 10 for available functions)	RPB
Indicator Outside Only with Icons - Green/Red	V30
Indicator Outside Only with Icons - White/Red	V60
Indicator Inside Only with Icons - Green/Red	V03
Indicator Inside Only with Icons - White/Red	V06
Indicator Both Sides with Icons - Green/Red	V33
Indicator Both Sides with Icons - White/Red	V66

### Miscellaneous Options

Description	Specify
Spanner head screws	M02
Torx® head screws	M04
Less cylinder, with tailpiece for Schlage® 6-pin fixed core cylinder (all designs)	M06
Lever to accept 6 or 7-pin SFIC (all designs)	M08
Lever to accept SARGENT® 6-pin fixed core cylinder (all designs)	M09
Rounded corners on latch front	M13
1" latch front, rounded corners (2-3/8" backset only) <sup>1</sup>	M15
3/4" (19mm) throw fire latch <sup>1</sup>	M16
ANSI wrought strike box	M17
Knurling outside and inside (AZ, NZ, PZ only)	M20 <sup>2</sup>
Knurling outside only (AZ, NZ, PZ only)	M21 <sup>2</sup>
Knurling inside only (AZ, NZ, PZ only)	M22 <sup>2</sup>
Abrasive coat outside and inside (AZ, NZ, PZ only)	M23
Abrasive coat inside only (AZ, NZ, PZ only)	M24
Abrasive coat outside only (AZ, NZ, PZ only)	M25
Lead lining	M28
1-1/8" front, square corners (2-3/8" backset only) <sup>1</sup>	M32
Request to Exit (REX) Switch (Available with CLX33900 and all mechanical functions except dummy)	M92
Lever to accept Schlage® LFIC (AZ, NZ, PZ, BHSS, NVSL only)	M69
Rigid outside lever when locked	M200
Less cylinder, with tailpiece for ASSA ABLOY ACCENTRA™ 6-pin fixed core cylinder (all designs)	YC
Less cylinder, with tailpiece for ASSA ABLOY ACCENTRA™ 7-pin fixed core cylinder (all designs)	YC7
Lever to accept ASSA ABLOY ACCENTRA™ 6-pin LFIC (AZ, NZ, PZ, NVSL only)	YRC

<sup>1</sup> Not available with BHSS trim

<sup>2</sup> All levers provided in a powder coat finish will be supplied with an abrasive coating

### Finishes

Description		Specify
ANSI/BHMA 605 (US3)	Bright Brass	605
ANSI/BHMA 606 (US4)	Satin Brass	606
ANSI/BHMA 611 (US9)	Bright Bronze	611
ANSI/BHMA 612 (US10)	Satin Bronze	612
ANSI/BHMA 613 (US10B)	Dark Oxidized Satin Bronze, Oil Rubbed	613
613E	Dark Oxidized Satin Bronze - equivalent	613E
613L	Dark Oxidized Satin Bronze, Clear Coated	613L
ANSI/BHMA 618 (US14)	Bright Nickel Plated	618
ANSI/BHMA 619 (US15)	Satin Nickel Plated	619
619C	Satin Nickel Plated with MicroShield®	619C
ANSI/BHMA 625 (US26)	Bright Chromium Plated	625
ANSI/BHMA 626 (US26D)	Satin Chromium Plated	626
626C	Satin Chromium Plated with MicroShield®	626C
ANSI/BHMA 630 (US32D)	Satin Stainless Steel (BHSS only)	630
630C	Satin Stainless Steel with MicroShield® (BHSS only)	630C
722	Black Oxidized Bronze, Oil Rubbed	722
BSP	Black Suede Powder Coat	BSP
WSP	White Suede Powder Coat	WSP

Zinc levers are plated to match ANSI/BHMA finish.

### Lock/Cylinder Finish

Lock	Cylinder/Core*
605, 606, 611, 612, 613, 613E, 613L, 722	606
618, 619, 625, 626, 630, WSP	626
BSP	BSP

\*Finish when cylinder provided with lock, exceptions may apply.

# How to Order

## CLX3300 Series

### Ordering Examples

#### Stock Order

Quantity	Series/Function	Trim Lever/Rose	Finish	Hand
100	CLX3355	NZD	626	RHR

#### Split Trim / Finish Order

Quantity	Series/Function	Trim Lever/Rose		Finish		Hand
		Outside	Inside	Outside	Inside	
12	CLX3355	NZD	AZD	626	625	LH

#### Contract / Detailed Order

Quantity	Series/Function	Trim Lever/Rose	Finish	Hand	Door Thickness	Backset	Optional Strike	Misc. Options	Optional Cylinder	Keying	Keyset
24	CLX3355	NZD	626	RHR	D214	B334	SC114	M04-M16	C6	VK3	AA1

#### CLX33900 Electrified Series

Quantity	Series/Function	Trim Lever/Rose	Finish	Hand
6	CLX33903	AZD	626	RH

For Behavioral Health trim, see page 7

For Indicator trim, see page 8

#### How to Specify Handing:

Door hands determined from outside (secure side) of door.

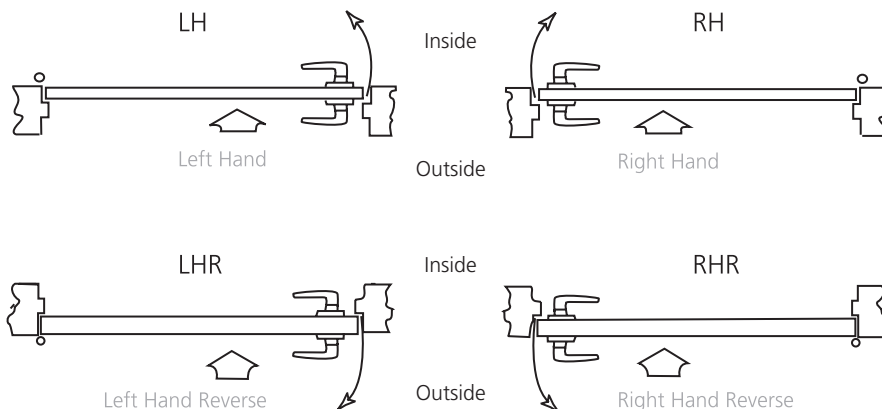

# How to Specify

## CLX3300 Series

### CLX3300 Series Suggested Specification

- A. Locks shall be CLX3300 Series cylindrical lever locks as manufactured by Corbin Russwin, Berlin, CT.
- B. Locks shall be ANSI/BHMA Certified Products Directory (CPD) listed.
  - 1. A156.2, Series 4000, Grade 1
  - 2. A156.41
- C. Locks shall exceed the requirements of ANSI/BHMA A156.2 Series 4000, Grade 1 with all standard trims, as follows:
  - 1. Cycle Test: Exceeds ANSI/BHMA A156.2 Grade 1 requirements with no lever sag. Verified by UL for Operational Cycling (V875753) at 20 Million Cycles.
  - 2. Abusive Locked Lever Torque: Exceeds 3,100 in-lb with no entry while maintaining egress (2.6 times ANSI/BHMA A156.2 requirements)
  - 3. Offset Lever Pull: Exceeds 1,600 lbs with no entry (8 times ANSI/BHMA A156.2 requirements)
  - 4. Latch Retraction with Preload: Exceeds 100lb preload while maintaining ANSI/BHMA requirements for operation in warped doors (2 times ANSI/BHMA A156.2 requirements)
  - 5. Vertical Impact: Exceeds 100 vertical impacts (20 times ANSI/BHMA A156.2 requirements)
- D. Locks shall comply with UL 10C positive pressure requirements.
- E. Locks required for fire doors shall be listed by Underwriters Laboratories for ratings of 3 hours (A label) and less, for doors up to 4'0" (1.2m) x 10'0" (3.0m) and pairs of doors 8'0" (2.4m) x 10'0" (3.0m)
- F. Locks shall have a push/turn button adjustable for door thickness without disassembly.
- G. Locks shall have a chassis design that supports all cylinder formats allowing flexibility for changing from fixed core to interchangeable core cylinders.
- H. Locks shall be non-handed with bi-directional lever operation.
- I. Lock levers shall be made of solid material.
- J. Lock shall be available in a minimum of seven different lever designs.
- K. Locks shall have a 2-3/4" (70mm) standard backset.
- L. Strikes shall be non-handed with a curved lip. Provide wrought boxes with strikes.
- M. Locks shall have brass 6-pin cylinder standard.
  - 1. Provide two nickel silver keys with each lock.
- N. Locks shall have approximately 45 degrees of lever rotation in order to fully retract latch.
- O. Locks shall have a ten-year limited warranty.

# How to Specify

## CLX3300 Series

### CLX3300 Series with BHSS Trim Suggested Specification

- A. Locks shall be CLX3300 Series cylindrical lever locks as manufactured by Corbin Russwin, Berlin, CT.
- B. Locks shall be listed for low, medium and high risk areas in the New York State Office of Mental Health (NYS-OMH) Patient Safety Standard.
- C. Locks shall be ANSI/BHMA Certified Products Directory (CPD) listed.
  - 1. A156.2, Series 4000, Grade 1
  - 2. A156.41
- D. Locks shall exceed the requirements of ANSI/BHMA A156.2 Series 4000, Grade 1 with all standard trims.
- E. Locks shall comply with UL 10C positive pressure requirements.
- F. Locks required for fire doors shall be listed by Underwriters Laboratories for ratings of 3 hours (A label) and less, for doors up to 4'0" (1.2m) x 10'0" (3.0m) and pairs of doors 8'0" (2.4m) x 10'0" (3.0m)
- G. Locks shall have a chassis design that supports all cylinder formats allowing flexibility for changing from fixed core to interchangeable core cylinders.
- H. Lock lever and escutcheon shall be made of solid stainless steel material.
- I. Locks shall have a 2-3/4" (70mm) standard backset.
- J. Strikes shall be non-handed with a curved lip. Provide wrought boxes with strikes.
- K. Locks shall be available with lead-lining and antimicrobial coating.
- L. Exposed fasteners shall be provided as Torx® security pin standard.
- M. Locks shall have brass 6-pin cylinder standard.
  - 1. Provide two nickel silver keys with each lock.
- N. Electrified functions shall be provided with EcoFlex® Technology.
- O. Locks shall have a ten-year limited warranty on mechanical components and a two-year limited warranty on electric components.

### CLX3300 Series with VSL Trim Suggested Specification

- A. Locks shall be CLX3300 Series cylindrical lever locks as manufactured by Corbin Russwin, Berlin, CT.
- B. Locks shall be ANSI/BHMA Certified Products Directory (CPD) listed.
  - 1. A156.2, Series 4000, Grade 1
  - 2. A156.41
- C. Locks shall exceed the requirements of ANSI/BHMA A156.2 Series 4000, Grade 1.
- D. Locks shall comply with UL 10C positive pressure requirements.
- E. Locks required for fire doors shall be listed by Underwriters Laboratories for ratings of 3 hours (A label) and less, for doors up to 4'0" (1.2m) x 10'0" (3.0m) and pairs of doors 8'0" (2.4m) x 10'0" (3.0m)
- F. Locks shall have a chassis design that supports all cylinder formats allowing flexibility for changing from fixed core to interchangeable core cylinders.
- G. Lock levers shall be made of solid material.
- H. Locks shall have indicator trim which visually displays the lock status of the door.
- I. Visual status indicators shall consist of six (6) individual windows for viewing at all angles.
- J. Visual status trim shall be non-handed and able to install easily on doors with any handing.
- K. Visual status indicators shall be available for the outside only, inside only or both sides of the door.
- L. Visual status indicators shall be available with a variety of non-keyed and keyed functions.
- M. Locks shall have a 2-3/4" (70mm) standard backset.
- N. Strikes shall be non-handed with a curved lip. Provide wrought boxes with strikes.
- O. Locks shall be available with lead-lining and antimicrobial coating.
- P. Locks shall have brass 6-pin cylinder standard.
  - 1. Provide two nickel silver keys with each lock.
- Q. Locks shall have a ten-year limited warranty on mechanical components.

# How to Specify

## CLX3300 Series

### CLX33900 with EcoFlex® Technology Suggested Specification

- A. Locks shall be CLX33900 cylindrical lever locks as manufactured by Corbin Russwin, Berlin, CT.
- B. Locks shall be ANSI/BHMA Certified Products Directory (CPD) listed.
  - 1. A156.2, Series 4000, Grade 1
  - 2. A156.41
- C. Locks shall exceed the requirements of ANSI/BHMA A156.2 Series 4000, Grade 1 with all standard trim.
- D. Locks shall comply with UL 10C positive pressure requirements.
- E. Locks required for fire doors shall be listed by Underwriters Laboratories for ratings of 3 hours (A label) and less, for doors up to 4'0" (1.2m) x 10'0" (3.0m) and pairs of doors 8'0" (2.4m) x 10'0" (3.0m)
- F. Locks shall be field configurable Fail Safe / Fail Secure by means of a dip switch setting.
- G. Locks shall have an operating voltage range from 10.2VDC to 26.4VDC.
- H. Locks shall have a continuous current draw of 10mA at 12VDC or 24VDC
- I. Locks shall have a chassis design that supports all cylinder formats allowing flexibility for changing from fixed core to interchangeable core cylinders.
- J. Locks shall be non-handed with bi-directional lever operation.
- K. Lock levers shall be made of solid material.
- L. Lock shall be available in a minimum of seven different lever designs.
- M. Locks shall have a 2-3/4" (70mm) standard backset.
- N. Strikes shall be non-handed with a curved lip. Provide wrought boxes with strikes.
- O. Locks shall have brass 6-pin cylinder standard.
  - 1. Provide two nickel silver keys with each lock.
- P. Locks shall have approximately 45 degrees of lever rotation in order to fully retract latch.
- Q. Locks shall have a two-year limited warranty on electric components.

# Notes

## CLX3300 Series

The ASSA ABLOY Group is the global leader in access solutions. Every day, we help billions of people experience a more open world.

ASSA ABLOY Opening Solutions leads the development within door openings and products for access solutions in homes, businesses and institutions. Our offering includes doors, frames, door and window hardware, mechanical and smart locks, access control and service.



For additional information, contact your  
ASSA ABLOY Door Security Solutions  
sales consultant or visit [www.corbinruswin.com](http://www.corbinruswin.com).

**In U.S.**

Corbin Russwin  
225 Episcopal Road  
Berlin, CT 06037  
Phone: 800-543-3658  
Fax: 800-447-6714  
[www.corbinruswin.com](http://www.corbinruswin.com)

**In Canada**

ASSA ABLOY Door  
Security Solutions Canada  
160 Four Valley Drive  
Vaughan, Ontario  
Canada L4K 4T9  
Phone: 800-461-3007  
Fax: 800-461-8989  
[www.assaabloydss.ca](http://www.assaabloydss.ca)

**MicroShield®**

ASSA ABLOY Group companies offer MicroShield®, an anti-microbial coating for door hardware. MicroShield uses proven silver ion-based technology from Agion®, a leading provider of antimicrobial solutions, to stem the spread of bacteria and other microbes.

MicroShield® is a trademark of ASSA ABLOY Access and Egress Hardware Group, Inc.



The Agion antimicrobial is not intended as a substitute for good hygiene. Coated products must still be cleaned to ensure the surfaces will be free of destructive microbes. ASSA ABLOY makes no representations or warranties, express or implied, as to the efficacy of the Agion antimicrobial. A copy of the Agion warranty is available upon request. Agion is a registered trademark of Agion Technologies, Inc., Wakefield, MA, USA.