

## 90 Series Exit Device



# 9900 Series Mortise Lock Exit Device

## 90 Series Exit Devices

**SARGENT®**  
**ASSA ABLOY**



### 9900 Mortise Lock Exit Device

The 9900 Series exit devices are ordered with trim and shipped complete with the strike, screw packs and cylinder as required in one carton. The cross bars are cut to the correct length, based on door width.

### Specifications

For Doors	Wood or metal. 1-3/4" (44.5mm) thick standard. Other door thickness, consult factory. 4-1/2" (114mm) minimum stile
Mounting	Supplied standard with wood and machine screws. Through-bolts available on order
Chassis Cover	Brass, bronze or stainless steel
Chassis	Nonferrous alloy
Crossbar	1" brass, bronze and stainless steel tubing. Specify 42- for reinforced cross bar
Hand	Handed, please specify hand when ordering
Mortise Lock	900 Series Mortise Lock, non-reversible
Dogging	Standard Allen key dogging
Strike	C908 standard for panic and fire rated
Fire Exit Hardware	See chart page 3

Copyright © 2006-2019, Sargent Manufacturing Company, an ASSA ABLOY Group company. All rights reserved. Reproduction in whole or in part without the express written permission of Sargent Manufacturing Company is prohibited.

### C908 Strike

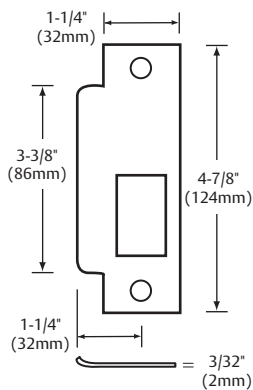

- Curved lip ANSI A115.1
- Handed. 1-1/4" lip standard
- Longer, lips in increments of 1/4" through 2-7/8" available
- Black nylon coated

### 815 Open Back Strike

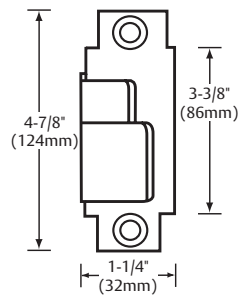

- ANSI A115.14 Open Back
- Beveled 1/8" in 2"
- Specify hand of active door
- "B" label
- Required for pairs of doors with 9700 and 9900 on pair
- Black nylon coated

### Single Door

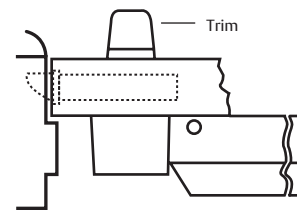

### Pair of Doors

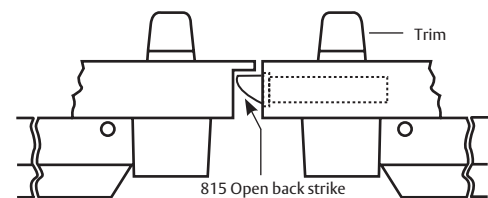

## 9900 Functions and Trims

### 90 Series Exit Devices

How to order:	Options 10-SG-	Series 99	Function 13	Trim ETL	Hand RHR	O/S Finish 26	I/S Finish 32	Door Width 36"	Options 9900
<b>700 Series ET Trim</b>  <p>Exits with ET Trim, specify lever design after the ET designation (e.g., ETL)</p> <p><b>Lever Designs for ET Controls</b>                      A, B, E, F, J, L, P, W                      Also available with Coastal Series &amp; Studio Collection Levers  <b>Note:</b> Voltage must be specified for 73, 74, 75 &amp; 76 function ET trims (12v or 24v)</p>			<b>SARGENT Function Numbers</b>	<b>ANSI Function Numbers</b>	<b>Description &amp; Cylinder Info (1-3/4" Door)</b>			<b>ANSI Type 3 8900 Panic &amp; Fire</b>	<b>Mechanical Options:</b> 12- 23- 31- 36- 37- 42- 54- 76- 85- 86- 87- CPC ***SG- TB-  <b>Cylinder Options:</b> 10- 10-21- 10-63- 11- 11-21- 11-60- 11-63- 11-64- 11-70-7P- 11-72-7P- 11-73-7P- 11-65-73-7P- 21- 22- 51- 52- 60- 63- 64- 70- 72- 73- 65-73- 65-73-7P- 73-7P- 81- 82- F1-82- 83- F1-83- 84- BR- LC- *SC- *SE-
			04	03	Night Latch Key Retracts Latch #46 Cylinder Supplied			9904 x ET_	
			10	01	No outside Operation (No Cylinder)			9910	
			10	02	No outside Operation (No Cylinder) ET Control is used as Pull Only			9910 x ET_	
			13	08	Key Outside Unlocks/locks Trim #41 Cylinder Supplied			9913 x ET_	
			15	14	Passage Only (No cylinder)			9915 x ET_	
			73		Electrified ET Trim - Fail Safe Power Off, Unlocks Lever (No Cylinder)**			9773 x ET_	
			74		Electrified ET Trim - Fail Secure Power Off, Locks Lever (No Cylinder)**			9774 x ET_	
			75++		Electrified ET Trim - Fail Safe Power Off, Unlocks Lever, Key Retracts Latch #46 Cylinder Supplied			9975 x ET_	
			76**		Electrified ET Trim - Fail Secure Power Off, Locks Lever, Key Retracts Latch #46 Cylinder Supplied			9976 x ET_	





**Note:** Exit devices are available in all standard finishes, except 14, 15, 26 & 26D. With these finishes, exit devices are supplied in 32 or 32D to match accordingly. For nickel finishes, specify 14/32 or 15/32D to receive nickel finished trims and stainless exit devices  
 ++ 75 Function without cylinder is available as a 73 Function  
 \*\* 76 Function without cylinder is available as a 74 Function

\* Options are not available with the following functions: 04 x ET, 75 & 76  
 \*\*\* Only available with 15, 26D, and 32D finishes

### Pull & Thumb Piece Trim Section

#### Trim Designations

- Use three letter designations (Ex "PTB") when ordering the exit device with trim
- Use the six digit designation (Ex "866-MAL") when ordering trim without an exit device, always specify finish & hand

SARGENT Function Numbers	ANSI Function Numbers	Description & Cylinder Info. (1-3/4" Door)	Series					9900 Panic & Fire
04	03	Night Latch-Key Retracts Latch #41 Cylinder Supplied						9904 x Trim Designation
10	02	No O/S Operation or Cylinder (Pull Only)	810-FLL	810-FLW	810-MAL	810-PTB	810-STL	9910 x Trim Designation
28	15	Passage Only (No cylinder)	828-FLL	828-FLW	828-MAL	828-PTB	828-STL	9928 x Trim Designation
63	05	Key Outside Unlocks/locks Trim #41 Cylinder Supplied	866-FLL	866-FLW	866-MAL	866-PTB	866-STL	9963 x Trim Designation

**Note:** Thumb piece trims used with mortise lock exit devices are handed  
**Note:** Thumb piece trims for 63 and 66 function devices are identical and are identified as 66 function when trim is ordered separately  
**Note:** Pulls and thumb piece trims are not available in 14, 15, 26 or 26D

### Available Finishes

SARGENT Finishes	BHMA Finishes
03	605
04	606
09	611
10	612
10BE	613
10BL	613E
14	614
15	618
20D	619
26	624
26D	625
32	626
32D	629
BSP	630
WSP	—

Copyright © 2006-2019, Sargent Manufacturing Company, an ASSA ABLOY Group company. All rights reserved. Reproduction in whole or in part without the express written permission of Sargent Manufacturing Company is prohibited.

## Finishes and Finish Care

### 90 Series Exit Devices

#### Finishes

SARGENT #	BHMA#	Description	How to clean	Avoid these cleaners
3	605	Polished brass, clear coated	Mild non-abrasive detergent with damp cloth or sponge	Abrasives cleaners, bleach solvents, steel or bronze wool
4	606	Satin brass, clear coated		
9	611	Polished bronze, clear coated		
10	612	Satin bronze, clear coated		
BSP	—	Black Suede Powder Coat		
WSP	—	White Suede Powder Coat	Lemon oil polished with dry cloth	Abrasives cleaners, bleach solvents, steel or bronze wool
10B	613	Oxidized bronze, oil rubbed		
10BE	613E	Dark oxidized satin bronze, equivalent		
10BL+	614	Oxidized satin, bronze, clear coated	Mild non-abrasive detergent with damp cloth or sponge	Abrasives cleaners, bleach solvents, steel or bronze wool
20D	624	Statuary dark bronze, clear coated		
32**†	629**	Polished stainless steel		
32D**†	630**	Satin stainless steel	Plastic pad or bronze wool	Cleaners, solvents, bleach, steel wool

+ **Note:** Finish not available, 9400 / 12-9400

\*\* Exit devices are available in all standard finishes, except 14, 15, 26 & 26D. With these finishes, exit devices are supplied in 32 or 32D to match accordingly. 26 or 26D is automatically supplied as a trim finish when 32 or 32D is specified for the exit device finish. For nickel finishes, specify 14/32 or 15/32D to receive nickel finished trims and stainless exit devices.

**Note:** Arms Nickel Plated to match 32 and 32D

**Note:** FLW Trim is NOT available in 32 or 32D

**Note:** Pulls and thumb piece trims are not available in 14, 15, 26 or 26D except FLW which is available in 14 and 15.

#### To avoid discoloration and pitting:

- Keep stainless steel away from contact with other metals
- Avoid cleaning with mineral acids or chlorine products
- Avoid cleaning with abrasive products like sandpaper or steel wool

#### To maintain the finish:

- Remove any contamination before damage occurs
- Protect with a metal polish or car wax

#### Suggested Architect's Specification

- All exit devices must be listed under "panic hardware" in accident equipment list of Underwriters' Laboratories
- All exit devices, regardless of type, shall be of matching design
- Crossbar must have minimum wall thickness of .062" or be reinforced
- Main arm pivots shall be stainless steel
- Springs shall be stainless steel
- Crossbars and arms shall be counter balanced by springs in both center case and hinge style cases
- All exit devices shall be of chassis mounted unit construction with removable covers
- Top and bottom rods of vertical rod devices shall be a minimum of 3/8" diameter
- Where labeled fire doors are used as exits, they must be equipped with labeled fire exit hardware
- All crossbars on exit devices to be locked down by inside dogging feature accomplished by depressing crossbar and turning key

#### Rod Replacement Kits

Product	Top Rod Kit *	Bottom Rod Kit **
3	670T	670B

**Note:** Finish Information Required  
 \* Door Height & Rail Location Required  
 \*\* Rail Location Required

#### 571 Rod Extension Kits

- For use on surface mounted vertical rods
- Kits available in 6" (15.2cm), 12" (30.4cm) or 18" (45.7cm) lengths

To order: Specify length and finish  
 Example: 571-6" x 26D

## Mullions: Aluminum, Steel and Electrified

### 90 Series Exit Devices

Aluminum Mullions			
Product Designation	650A	980	L980
Description	Removable	Removable	Lockable
Material	Aluminum	Aluminum	Aluminum
Standard Finish	US28/Satin Anodized Aluminum	Prime Coat	Aluminum Prime Coat
Options	Specify "650A x 10B" for 313AN to match 10B	Specify "980A" for Anodized US28/ Satin Aluminum	Specify: "L980A" Anodized Aluminum Specify: "L980A x 10B" for 313AN to match 10B
Stk Size	96"	96"	96"
Max Stk Height	120"	120"	120"
Pre-prepped	658 Strikes Included	No	No
Cylinder Size	Not Required	Not Required	#41
Shape	1-1/2" x 2-1/2"	T Shaped 2-1/2" x 3"	T Shaped 2-1/2" x 3"
Misc. Information and Accessories	Includes 651 Stabilizers and imbedded Weather Stripping Top Retainer 94-2050 Bottom Retainer 94-2051	Top Retainer - 511 Bottom Retainer - 502 Adapter for narrow transom: 507 - Aluminum Prime Coated 507A - Anodized Aluminum	All Cylinder Options Available Wall Mount Kit 98-2578 Top Ret Pack 98-2526 Bottom Ret Pack 98-2525 Cylinder Kit 980C1*

Electrified
EL980
Electrical Lockable
Steel
Gray Paint
Wall Mounting Kit: 98-2580 Top Ret Pack :98-2559
96"
120"
No
#46 Only
Rectangular 2" x 3"
For use with Electric Strikes and Monitoring, Quick Connect Wiring Supplied Cylinder Kit 980C2*

\* Note: Cylinder Kits must be ordered separately

Steel Mullions					
Product Designations	HC980	980S	L980S	HCL980	12-HD980
Description	Hurricane Code	Standard Mullion	Lockable	Lockable Hurricane Code	Heavy Duty
Material	Steel	Steel	Steel	Steel	Steel
Fire Rated	Specify 12-HC980	Specify 12-980	Specify 12-L980	Specify 12-HCL980	Specify 12-HD980
Fire Rated Max Height	96"	96"	96"	96"	120"
Finish	Gray Paint	Gray Paint	Gray Paint	Gray Paint	Gray Paint
Stk Size	96"	96"	96"	96"	120"
Max Stk Height	96"	120"	120"	96"	120"
Pre-prepped	No	No	No	No	No
Cylinder Size	Not Required	Not Required	#41 Std (#42 & #43 available)	#41 Std (#42 & #43 available)	Not Required
Shape	Rectangular 2" x 3"	Rectangular 2" x 3"	Rectangular 2" x 3"	Rectangular 2" x 3"	Rectangular 2" x 3"
Misc. Information	Designed for severe wind load conditions due to hurricanes or windstorms. Tested to Dade County Protocols & ASTM Standards	Channel Iron & Malleable iron top & bottom retainers	Fire rated for 8'0" x 8'0" paired openings	See Notes Below	12-HD980 is for pair of doors over 8'0" to 10'0" includes two piece strikes
Accessories	Top Ret Pack - 98-2599 Bottom Ret Pack - 98-2600 Top Retainer Shim Kit - 601	Top Ret Pack - 98-2190 Bottom Ret Pack - 98-2191 Top Retainer Shim Kit - 601	Wall Mounting Kit - 98-2579 Top Ret Pack - 98-2559 Bottom Ret Pack - 98-2556 Top Retainer Shim Kit - 601 Cylinder Kit 980C1*	Top Retainer Pack: 98-2593 Bottom Retainer Pack: 98-2594 Top Retainer Shim Kit - 601 Cylinder Kit 980C1*	Top Ret Pack - 98-2599 Bottom Ret Pack - 98-2600 Top Retainer Shim Kit - 601

\* Note: Cylinder Kits must be ordered separately

### Note for HC980/12-HC980 Mullions:

- Designed for severe wind load conditions due to hurricanes or tornadoes
- Tested to Dade County protocols and ANSI 250.13 ASTM Standards and FEMA 361
- 12- Fire labeled version
- Replacement lock kits are available for lockable mullions  
Part numbers for each model are listed in the price book

### HCL980 Mullion Information

- Model 12-HC-L980 may be supplied for doors UL fire rated up to and including 3 hrs not exceeding 8 ft in width and height
- Meets the following standards: ANSI 250.13, ASTM E330, ASTM 1886, ASTM 1996, TAS 201, TAS 202 & TAS 203

### Lockable Mullion Cylinder Kit Options

Lockable mullions are shipped without cylinders. Order Cylinder Mullion Kit separately.

- L980, L980A, L980S & HC-L980 are 10, 10-21-, 10-63-, 11-, 11-21-, 11-60, 11-63-, 11-64-, 11-72-7P-, 11-65-73-7P-, 11-73-7P-, 21-, 22-, 60-, 63-, 64-, 70, 72-, 73-, 65-73-, 65-73-7P-, 73-7P-, 81-, 82-, F1-82-, 83-, F1-83-, 84-, SC- & SE-
- EL980 are 10, 10-21-, 10-63-, 11-, 11-21-, 11-60, 11-63-, 11-64-, 11-72-7P-, 11-65-73-7P-, 11-73-7P-, 21-, 22-, 60-, 63-, 64-, 70, 72-, 73-, 65-73-, 65-73-7P-, 73-7P-, 81-, 82- & F1-82-

Note: See page 20 for option details

# Mullion Accessories, Stabilizers and Door Coordinators

## 90 Series Exit Devices

**SARGENT®**

**ASSA ABLOY**

### Mullion Accessories

#### RK980

Latchbolt assembly retrofit kit with top and bottom retainers for 980 aluminum mullion.



### 507 Narrow Transom Bars Adapter

- Available with 980 and 980A
- Required when soffit is 1-1/4" (32mm) to 2" (51mm) wide

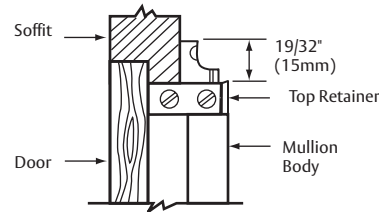

### 980S Mullion Application

- All steel mullions are 2" x 3"

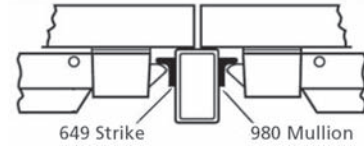

### 980 Mullion & L980 Lockable Mullion

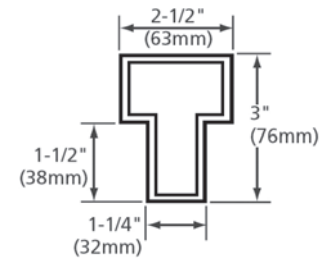

### Lockable Mullion

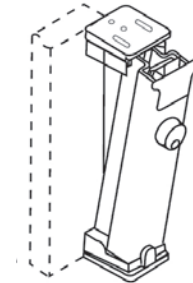

### 651 Mullion Stabilizer Kit

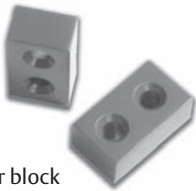

- Stabilizer block
- Furnished standard w/650A Mullion
- Order as a 651 Kit

### 650A Mullion

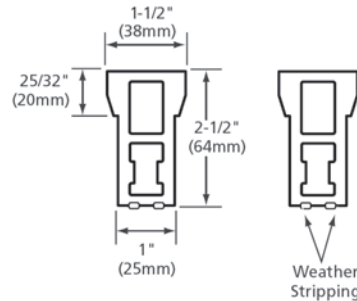

### Mullion Weights & Packaging

Product	Avg Wt	Case
Exit Device with Trim	15 lbs	1 ea
980 Mullion	18 lbs	1 ea
12-980 Mullion	40 lbs	1 ea
650A Mullion	18 lbs	1 ea

### 980C1 Cylinder Mullion Kit



- Lockable mullions only
- Aluminum and steel
- Includes cylinder and collar

### Cylinder Nut Wrench



This wrench simplifies the installation and removal of mortise cylinders nuts used on 700 Series Auxiliary Control (80 Series ET Trim).

- Part number 97-0568

### 980C2 Cylinder Mullion Kit



- Lockable mullions
- Electrified only
- Includes cylinder and collar

Copyright © 2006-2019, Sargent Manufacturing Company, an ASSA ABLOY Group company. All rights reserved. Reproduction in whole or in part without the express written permission of Sargent Manufacturing Company is prohibited.

# Mechanical Options and Descriptions

## 90 Series Exit Devices

### Mechanical Options:

Fire Rated	12-	UL Fire Label Exit hardware
SVR Bolt	14-	Sliding bolt bottom case for 9700
Alternate Strike	23-	4-7/8" (124mm) ANSI flat lip strike (for 9900 Series Mortise Lock Exit Devices)
Thick Doors	31-	Doors over 1-3/4" and/or Panels (Specify door thickness, panel thickness & location as required) (Not available with 9400 Devices) Extended lip strike supplied for 9900 Series
Security Fasteners	36-	Six lobe security head screws
	37-	Spanner head screws
Reinforced Cross Bar	42-	Reinforced Cross Bar (Not available with 9400 Devices)
Electrical Options	54-	Monitors ET Lever movement with Internal micro switch in ET Control
Tactile Warning Options	76-	Tactile Warning - Milled Outside Lever (Not available with Studio & Coastal Levers and the A Lever)
	85-	Tactile Warning - Abrasive strip on Cross Bar
	86-	Tactile Warning - Abrasive coating on Outside Lever
	87-	Tactile Warning - Abrasive strip on Cross Bar & Abrasive coating on Outside Lever
Finish Protection	CPC-	Clear Powder Coat (Available for 32 & 32D Finishes)
	SG-	MicroShield® antimicrobial clear powder coat (only available with 15, 26D and 32D finishes)
Through Bolts	TB-	Through-bolts for 9900, 9800 & 9700 Devices

**Note:** Tactile Warning with Knurled Cross Bars is available, please consult factory (not available with 9400 devices)

### Mounting Heights

- 36" (914mm) Cross Bar above finished floor for standard application

#### Hand

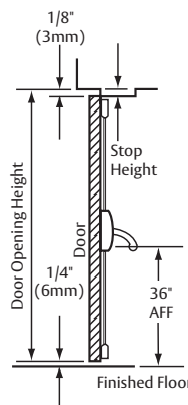
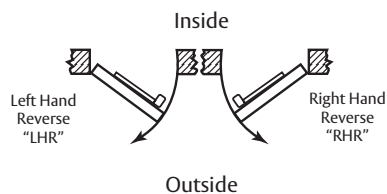

# Cylinder Options and Descriptions

## 90 Series Exit Devices



### Cylinder Options:

Degree Key System	<b>DG1-</b>	SARGENT Degree Key System Level 1 (bump resistant with patented keys)
	<b>DG1-21-</b>	Degree Level 1 Construction Master Keying
	<b>DG1-60-</b>	Degree Level 1 Removable Disposable Construction Core
	<b>DG1-63-</b>	Degree Level 1 Removable Core
	<b>DG1-64-</b>	Degree Level 1 Removable Construction Keyed LFIC
	<b>DG1-65-</b>	Degree Level 1 Unassembled/Uncombined Core
	<b>DG2-</b>	SARGENT Degree Key System Level 2 (geographically exclusive; bump and pick resistant)
	<b>DG2-21-</b>	Degree Level 2 Construction Master Keying
	<b>DG2-60-</b>	Degree Level 2 Removable Disposable Construction Core
	<b>DG2-63-</b>	Degree Level 2 Removable Core
	<b>DG2-64-</b>	Degree Level 2 Removable Construction Keyed LFIC
	<b>DG2-65-</b>	Degree Level 2 Unassembled/Uncombined Core
	<b>DG3-</b>	SARGENT Degree Key System Level 3 (geographically exclusive; UL437 certified; bump and pick resistant)
	<b>DG3-21-</b>	Degree Level 3 Construction Master Keying
	<b>DG3-60-</b>	Degree Level 3 Removable Disposable Construction Core
	<b>DG3-63-</b>	Degree Level 3 Removable Core
<b>DG3-64-</b>	Degree Level 3 Removable Construction Keyed LFIC	
Signature Key System	<b>10-</b>	SARGENT Signature Key System (Not Available with other Key Systems)
	<b>10-21-</b>	SARGENT Signature Construction Key System (Lost Ball)
Signature- LFIC Removable Core	<b>10-63-</b>	SARGENT Signature Removable Core Cylinder
XC- Key System	<b>11-</b>	XC Key System (Not available with other Key systems unless specified)
	<b>11-21-</b>	XC- Construction Key System (Lost Ball)
XC- Large Format Interchangeable Core (Removable Core)	<b>11-60-</b>	Device to accept XC- Permanent Removable Core, Disposable plastic Core- provided
	<b>11-63-</b>	Device provided with XC- Removable Core Cylinder - (Includes masterkeying, grand masterkeying)
	<b>11-64-</b>	Device provided with Keyed construction core to accept XC- Removable Permanent Core (ordered separately)
XC- Small Format Interchangeable Core	<b>11-70-7P-</b>	Device to accept XC- SFIC ( 7-Pin) XC- Permanent Cores, plastic disposable core provided
	<b>11-72-7P-</b>	Device to accept XC- SFIC (7-pin Keyed Construction Core provided) cylinder Permanent core ordered separately
	<b>11-73-7P-</b>	Device provided with XC- Small Format 7-Pin interchangeable core (Includes masterkeying, grand masterkeying)
	<b>11-65-73-7P-</b>	Device provided to accept XC- Uncombined 7-Pin SFIC (Permanent) Core - (Packed Loose)

Copyright © 2006-2019, Sargent Manufacturing Company, an ASSA ABLOY Group company. All rights reserved. Reproduction in whole or in part without the express written permission of Sargent Manufacturing Company is prohibited.



# Cylinder Options and Descriptions

## 90 Series Exit Devices

### Cylinder Options:

Construction Key Systems	21-	SARGENT Lost Ball Construction Keying for Conventional, XC and Signature Series (N/A with 63- or 73-)
	22-	SARGENT Construction Split Key System for Conventional Cylinders (Existing Systems Only) (N/A with 10-, 11-, 63- or 73-)
Old Style Removable Core	51-	Removable Core Cylinder (Old Style) provided (existing systems only)
	52-	Removable Construction Core (Old Style) Permanent core ordered separately (existing systems only)
Large Format Interchangeable Core (Removable Core)	60-	Device to accept SARGENT Permanent Removable Core, Disposable plastic Core provided (Permanent Cores ordered separately)
	63-	Device provided with Removable Core Cylinder - (Includes masterkeying, grand masterkeying)
	64-	Device provided with Keyed construction core to accept Removable Permanent Core (ordered separately)
Small Format Interchangeable Core	70-	Device to accept 6- or 7-Pin SFIC Permanent Cores, plastic disposable core provided
	72-	Device to accept 6- or 7-Pin SFIC (6-Pin Keyed Construction Core provided) Cylinder (Permanent Core ordered separately)
	73-	Device provided with 6-pin SFIC (Includes masterkeying, grand masterkeying)
	65-73-	Device provided to accept Uncombined 6-Pin SFIC (Permanent) Core - (Packed Loose for field keying)
	65-73-7P-	Device provided to accept Uncombined 7-Pin SFIC (Permanent) Core - (Packed Loose for field keying)
	73-7P-	Device provided with Small Format 7-Pin Interchangeable Core (Includes masterkeying, grand masterkeying)
Keso & Keso F1	81-	Device provided with housings to accept Keso (83) & Keso F1 (F1-83-) removable cores. (Permanent Cores ordered separately)
	82-	Device provided with SARGENT Keso Security Cylinder
	F1-82-	Device provided with SARGENT Keso F1 Security Cylinder (Patented)
	83-	Device provided with SARGENT Keso Security Removable Core cylinder
	F1-83-	Device provided with SARGENT Keso F1 Security Removable Core cylinder (Patented)
	84-	Device provided with SARGENT Keso Construction Cores (Permanent Cores ordered separately)
Added Security	BR-	Bump Resistant Cylinder (Available with Conventional & Conventional XC Cylinders Only)
Less Cylinder	LC-	Less Cylinder - SARGENT supplies standard blocking rings for 1-1/8" Cylinders (For longer cylinders order collars/rings separately)
Schlage Keyways	SC-	Schlage C keyway cylinder, 0 bitted
	SE-	Schlage E keyway cylinder, 0 bitted